

Owner's Manual  
for Vehicle



The Ultimate  
Driving Machine



## 645Ci Owner's Manual for Vehicle

Congratulations, and thank you for choosing a BMW.

Thorough familiarity with your vehicle will provide you with enhanced control and security when you drive it. We therefore have this request:

Please take the time to read this Owner's Manual and familiarize yourself with the information that we have compiled for you before starting off in your new vehicle. It contains important data and instructions intended to assist you in gaining maximum use and satisfaction from your BMW's unique range of technical features. The manual also contains information on maintenance designed to enhance operating safety and contribute to maintaining the value of your BMW throughout an extended service life.

This Owner's Manual should be considered a permanent part of this vehicle. It should stay with the vehicle when sold to provide the next owner with important operating, safety and maintenance information.

This manual is supplemented by a Service and Warranty Information Booklet for US models or a Warranty and Service Guide Booklet for Canadian models.

We wish you an enjoyable driving experience.

BMW AG

© 2004 Bayerische Motoren Werke  
Aktiengesellschaft  
Munich, Germany  
Reprinting, including excerpts,  
only with the written consent of  
BMW AG, Munich.  
Order No. 01 41 0 158 445  
US English VIII/04, 04 09 500  
Printed in Germany  
Printed on environmentally friendly paper,  
bleached without chlorine, suitable for recycling.

# Contents

The fastest way to find specific topics is to use the index, refer to page [199](#).

## Using this Owner's Manual

[4](#) Notes

Reporting safety defects [7](#)

## At a glance

[10](#) Cockpit

[16](#) Control Center

[22](#) Voice command system

## Controls

[28](#) Opening and closing

[44](#) Adjustments

[52](#) Transporting children safely

[54](#) Driving

[69](#) Everything under control

[80](#) Technology for comfort, convenience and safety

[91](#) Lamps

[94](#) A congenial climate

[100](#) Practical interior accessories

## Driving tips

[108](#) Things to remember when driving

## Navigation

[114](#) Starting navigation system

[115](#) Destination entry

[124](#) Destination guidance

[129](#) What to do if ...

## Entertainment

[132](#) On/off and tone

[136](#) Radio

[143](#) CD player and CD changer

## Communications

[150](#) Telephoning

[159](#) TeleService, BMW Assist

## Mobility

[166](#) Refueling

[168](#) Wheels and tires

[174](#) Under the hood

[178](#) Maintenance

[180](#) Replacing components

[185](#) Giving and receiving assistance

## Reference

[192](#) Technical data

[196](#) Short commands of the voice command system

[199](#) Everything from A to Z

# Notes

## Using this Owner's Manual

We have made every effort to ensure that you are able to find what you need in this Owner's Manual as quickly as possible. The fastest way to find specific topics is to use the detailed index at the back of the manual. If you wish to gain an initial overview of your vehicle, you will find this in the first chapter.

Should you want to sell your BMW some day, please remember to hand over the Owner's Manual as well; it is an important component of your vehicle.

### Additional sources of information

Should you have any other questions, your BMW center will be glad to advise you at any time.

You can find information on BMW, e.g. technology, on the Internet at [www.bmwusa.com](http://www.bmwusa.com).

## Symbols used



Indicates precautions that must be followed precisely in order to avoid the possibility of personal injury and serious damage to the vehicle.



Indicates information that will assist you in gaining the optimum benefit from your vehicle and enable you to care more effectively for your vehicle.



Refers to measures that can be taken to help protect the environment.

◀ Marks the end of a specific item of information.

\* Indicates special equipment, country-specific equipment and optional extras, as well as equipment and functions not yet available at the time of printing.

"..." Identifies Control Display texts used to select individual functions.

### Symbols on vehicle components



Indicates that you should consult the relevant section of this Owner's Manual for information on a particular part or assembly.

## The individual vehicle

On purchasing your BMW, you have decided in favor of a model with individualized equipment and features. This Owner's Manual describes the entire array of options and equipment available with a specific BMW model.

Please bear in mind that the manual may contain information on accessories and equipment that you have not specified for your own vehicle. Sections describing options and special equipment are marked by asterisks \* to assist you in identifying possible differences between the descriptions in this manual and your own vehicle's equipment.

If equipment in your BMW is not described in this Owner's Manual, please refer to the accompanying Supplementary Owner's Manuals.

## Editorial notice

BMW pursues a policy of continuous, ongoing development that is conceived to ensure that our vehicles continue to embody the highest quality and safety standards combined with advanced, state-of-the-art technology. In isolated cases it is possible that the features described in this Owner's Manual could differ from those on your vehicle.

## For your own safety

### Maintenance and repair

 Advanced technology, e.g. the use of modern materials and high-performance electronics, requires specially adapted maintenance and repair methods. Therefore, have corresponding work on your BMW carried out only by a BMW center or a workshop that works according to BMW repair procedures with correspondingly trained personnel. If work is carried out improperly there is a danger of consequential damage and the related safety risks. ◀

### California Proposition 65 Warning

California law requires us to issue the following warning:

 Engine exhaust and a wide variety of automobile components and parts, including components found in the interior furnishings in a vehicle, contain or emit chemicals known to the State of California to cause cancer and birth defects and reproductive harm. In addition, certain fluids contained in vehicles and certain products of component wear contain or emit chemicals known to the State of California to cause cancer and birth defects or other reproductive harm.

Battery posts, terminals and related accessories contain lead and lead compounds. Wash your hands after handling.

Used engine oil contains chemicals that have caused cancer in laboratory animals. Always protect your skin by washing thoroughly with soap and water. ◀

## Parts and accessories

 For your own safety, use genuine parts and accessories approved by BMW.

When you purchase accessories tested and approved by BMW and Genuine BMW Parts, you simultaneously acquire the assurance that they have been thoroughly tested by BMW to ensure optimum performance when installed on your vehicle.

BMW warrants these parts to be free from defects in material and workmanship.

BMW will not accept any liability for damage resulting from installation of parts and accessories not approved by BMW.

BMW cannot test every product made by other manufacturers to verify if it can be used on a BMW safely and without risk to either the vehicle, its operation, or its occupants.

Genuine BMW Parts, BMW Accessories and other products approved by BMW, together with professional advice on using these items, are available from all BMW centers.

Installation and operation of non-BMW approved accessories such as alarms, radios, amplifiers, radar detectors, wheels, suspension components, brake dust shields, telephones, including operation of any mobile phone from within the vehicle without using an externally mounted antenna, or transceiver equipment, for instance, CBs, walkie-talkies, ham radios or similar accessories, may cause extensive damage to the vehicle, compromise its safety, interfere with the vehicle's electrical system or affect the validity of the BMW Limited Warranty. Refer to your BMW center for additional information. ◀

 Maintenance, replacement, or repair of the emission control devices and systems may be performed by any automotive repair establishment or individual using any certified automotive part. ◀

## Service and warranty

We recommend that you read this publication thoroughly.

Your BMW is covered by the following warranties:

- ▷ New Vehicle Limited Warranty
- ▷ Rust Perforation Limited Warranty
- ▷ Federal Emissions System Defect Warranty
- ▷ Federal Emissions Performance Warranty
- ▷ California Emission Control System Limited Warranty

Detailed information about these warranties is listed in the Service and Warranty Information Booklet for US models or in the Warranty and Service Guide Booklet for Canadian models.

## Reporting safety defects

The following applies only to vehicles owned and operated in the US.

If you believe that your vehicle has a defect which could cause a crash or could cause injury or death, you should immediately inform the National Highway Traffic Safety Administration (NHTSA) in addition to notifying BMW of North America, LLC, P.O. Box 1227, Westwood, New Jersey 07675-1227, Telephone (800) 831-1117.

If NHTSA receives similar complaints, it may open an investigation, and if it finds that a safety defect exists in a group of vehicles, it may order a recall and remedy campaign. However, NHTSA cannot become involved in individual problems between you, your dealer, or BMW of North America, LLC.

To contact NHTSA, you may either call the Auto Safety Hotline toll-free at 1-800-424-9393 (or 366-0123 in Washington, D.C. area) or write to: NHTSA, U.S. Department of Transportation, Washington, D.C. 20590. You can also obtain other information about motor vehicle safety from the Hotline.







## At a glance



This overview of buttons, switches and displays is intended to familiarize you with your vehicle's operating environment. The section will also assist you in becoming acquainted with the control concepts and options available for operating the various systems.

# Cockpit

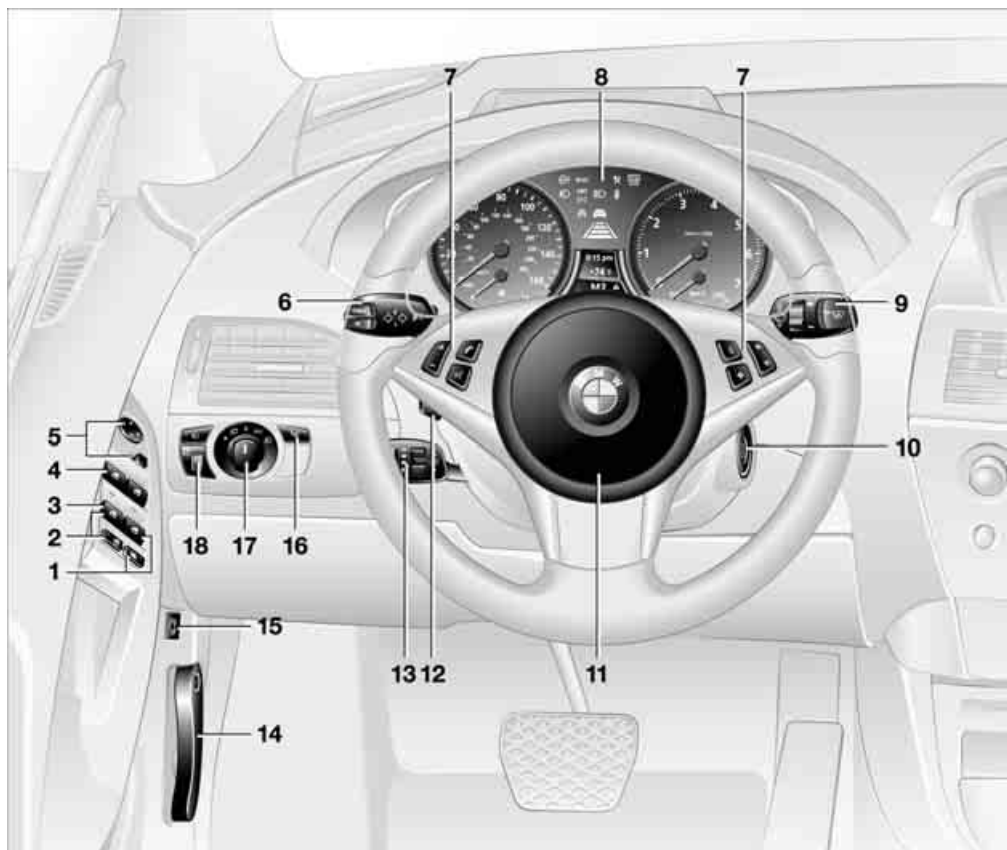
## All around the steering wheel: controls and displays



- 1 Convertible: opening and closing rear window [37](#)
- 2 Convertible: opening and closing windows together [36](#)
- 3 Convertible: opening and closing back windows [36](#)
- 4 Opening and closing front windows [35](#)
- 5 Adjusting exterior mirrors [49](#)

- 6  Turn signals [60](#)
-  High beams, headlamp flasher [92](#)
-  Roadside parking lamps [92](#)
- CHECK Check Control [71](#)
- BC Computer [74](#)

## 7 Buttons on steering wheel



Portable phone\* 151

- ▷ Press: accept call or terminate call  
as well as dial if an entry has been selected from "A - Z", "Top 8", "Redial", "Received calls" or "Missed calls"
- ▷ Press longer: redialing



Volume



Activate/deactivate voice command system\* 22



Forward/reverse 132



- ▷ Radio  
Press: change radio station  
Press longer: manual tuning or automatic station-search function scan
- ▷ CD  
Press: select track  
Press longer: fast forward/reverse
- ▷ Portable phone  
Press: select entry in "A - Z", "Top 8", "Redial", "Received calls" or "Missed calls"



Individually programmable\* 51



Individually programmable 51

8 Instrument cluster 12



Windshield wipers 60



Rain sensor 61

10 Ignition lock 54

11 Horn: the entire surface

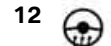

Steering wheel heater\* 51



Steering wheel adjustment 50

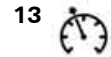

13 Cruise control 61



Active cruise control\* 62

14 Releasing the hood 174

15 Opening the luggage compartment lid 32

16 Head-Up Display\* 88

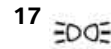

17 Parking lamps 91



Low beams 91



Automatic headlamp control 91  
Adaptive Head Light\* 92



18 Instrument lighting 93



Front fog lamps 92

## Instrument cluster



- 1 Indicator lamps for turn signals [13](#)
- 2 Speedometer
- 3 Indicator and warning lamps [13](#)
- 4 Display for active cruise control\* [64](#)
- 5 Tachometer [69](#)  
and Engine oil thermometer [70](#)
- 6 Display for
  - ▷ Time/date [69](#)
  - ▷ Outside temperature [69](#)
  - ▷ Indicator and warning lamps [71](#)
  - ▷ Speed for cruise control [62](#)
  - ▷ Desired speed for active cruise control\* [64](#)
- 7 Display for
  - ▷ Odometer and trip odometer [69](#)
  - ▷ Computer [74](#)
  - ▷ Date and remaining distance to be driven for service requirement [70](#)
  - ▷ Automatic transmission with Steptronic\* [58](#)
  - ▷ SMG Sequential manual transmission\* [57](#)
  - ▷ Dynamic Driving Control [59](#)
  - ▷  Check Control message present [71](#)
- 8 Fuel gage [70](#)
- 9 Resetting the trip odometer to zero [69](#)

# Indicator and warning lamps

## The concept









Indicator and warning lamps and their combinations appear in the indicator area **1** and in the display **2**. For better differentiation of malfunctions, different symbols can appear in the display **2**.

Some lamps in the indicator area **1** are checked for proper operation when the engine is started or the ignition is switched on and light up briefly in the process.

## Confirmation of active functions

The following indicator lamps in the indicator area **1** indicate that certain functions are active:

-  Turn signals [60](#)
-  Handbrake set [55](#)
-  Handbrake for Canadian models
-  Front fog lamps [92](#)
-  DTC Dynamic Traction Control [83](#)
-  High beams/headlamp flasher [92](#)
-  DSC Dynamic Stability Control [83](#)

## Required action in case of a malfunction



All warning lamps and indicator lamps not previously listed are also accompanied by text messages at the bottom of the Control Display. These may contain detailed information on the cause of a malfunction and the corresponding action required.

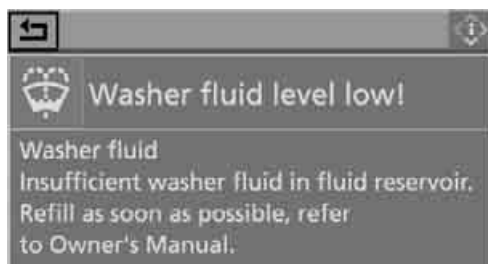





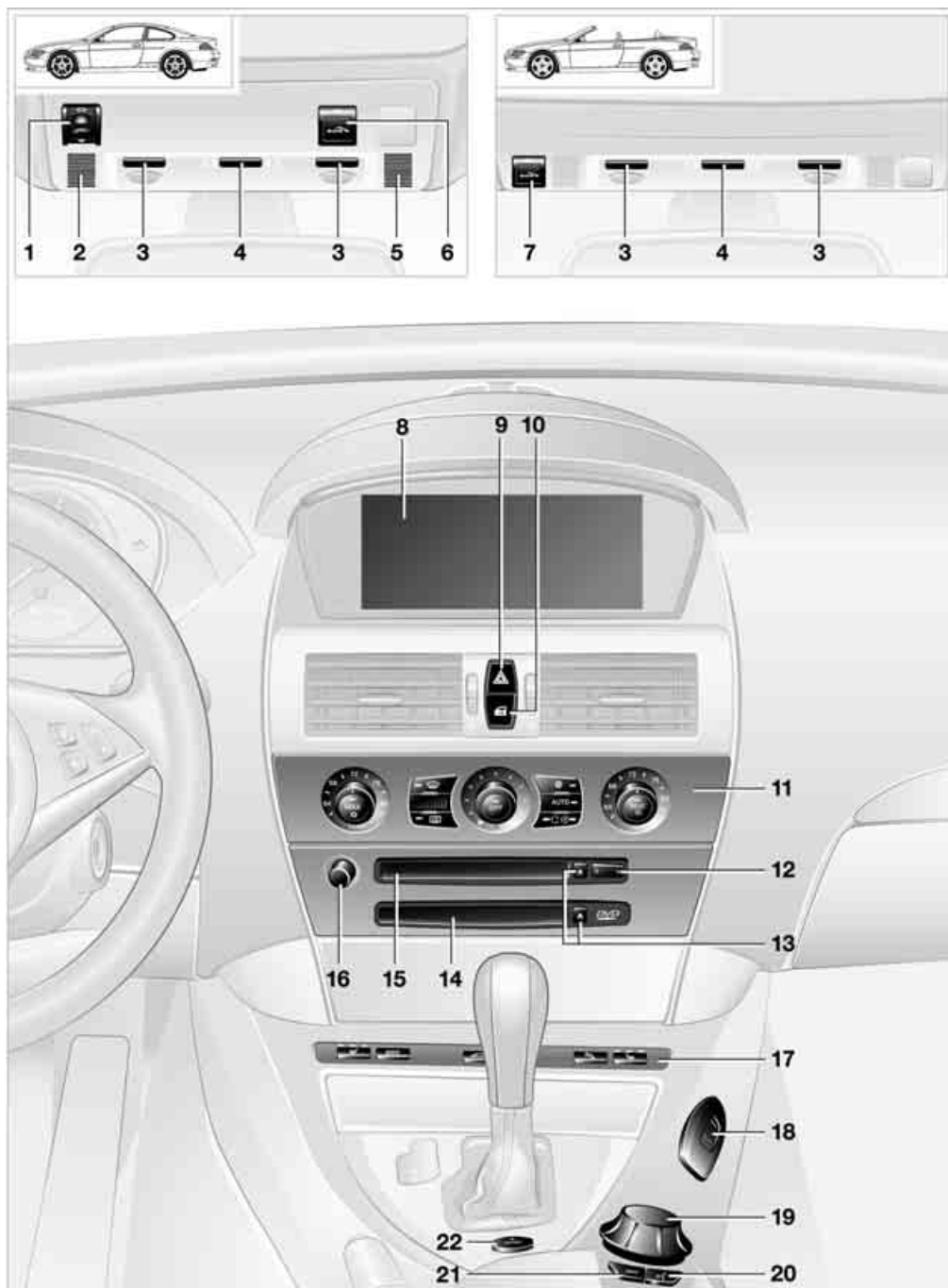









Sometimes warning lamps are also accompanied by additional text messages on the Control Display which are displayed immediately. Text messages which do not appear immediately are stored and can be displayed at a later time. For details on displaying these messages later, refer to Check Control on page [71](#).

## All around the center console: controls and displays





- 1 Coupe: glass sunroof, electric with raise function\* 37
- 2 Microphone for portable phone\* 151  
Convertible: microphone on steering column
- 3 Reading lamps 93
- 4 Interior lamps 93
- 5 Microphone for voice command system\* 22  
Convertible: microphone on steering column
- 6 Coupe: initiating emergency call\* 185
- 7 Convertible: initiating emergency call\* 185
- 8 Control Display 16
- 9 Hazard warning flashers
- 10 Central locking system 31
- 11 Automatic climate control 94
  -  Temperature setting, left/right 95
  -  Automatic air distribution and volume 95
  -  Cooling function 95
  -  AUC Automatic recirculated-air control 95
  -  Maximum cooling 95
  -  Residual heat mode 96
  -  Switching off automatic climate control 96
  -  Air volume 95
  -  Defrosting windows and removing condensation 95
  -  Rear window defroster 94

- 12 Starting search function
  - ▷ for radio station 137
  - ▷ for track 144
- 13 Ejecting
  - ▷ navigation DVD\* 114
  - ▷ audio CD 132
- 14 Drive for navigation DVDs\* 114
- 15 Drive for audio CDs 132
- 16 Switching audio sources on/off and adjusting volume 132
- 17  Heated seats 49
  -  PDC Park Distance Control\* 80
  -  DTC Dynamic Traction Control 82
  -  Convertible: opening the convertible top 40
  -  Convertible: closing the convertible top 40
- 18 Bracket for cup holder 103
- 19 Controller 16
- 20 Activating voice command system\* 22
- 21 Opening start menu on Control Display 17
- 22 Dynamic Driving Control 59



# Control Center

The Control Center groups the functions of a large number of switches. This allows these functions to be operated from a central position. The following section provides an introduction

to basic menu navigation. The control of individual functions is described in connection with the relevant equipment.

## Controls

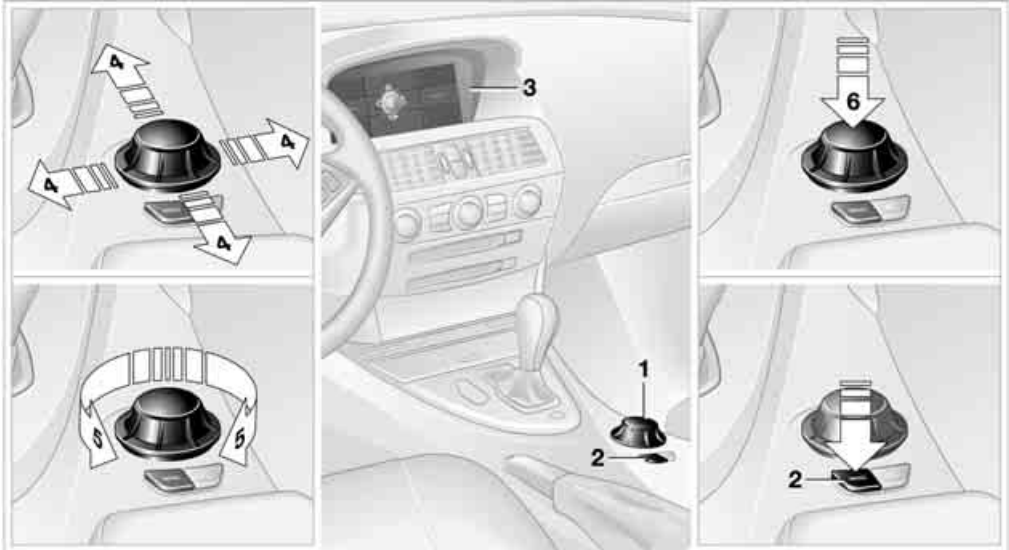

- 1 Controller
- 2 **MENU** button: open the start menu from any menu
- 3 Control Display

By moving the controller 1 horizontally in four directions 4, turning 5 and pressing 6, you can

navigate through the menus of the Control Center and change settings.

 To avoid posing an unnecessary hazard due to inattention, both to your own vehicle's occupants and to other road users: never attempt to use the controls or make entries unless traffic and road conditions allow. ◀

## Menu overview

You can call up all the functions in the Control Center using five menu items.

### Communication

- ▷ Portable phone\*
- ▷ BMW Assist\* or TeleService\*

### Navigation or onboard information

- ▷ Navigation system\*
- ▷ Onboard information, e.g. for display of the average fuel consumption

## Entertainment

- ▷ Radio
- ▷ CD player and CD changer\*

## Climate

- ▷ Air distribution
- ▷ Independent ventilation

## i menu

- ▷ Switching off the Control Display
- ▷ Tone and display settings
- ▷ Settings for traffic information
- ▷ Settings for your vehicle, e.g. for the central locking system
- ▷ Display of the service requirements and dates for statutory emission and vehicle inspections

## Menu navigation

As of ignition key position 1, the following message appears on the Control Display:

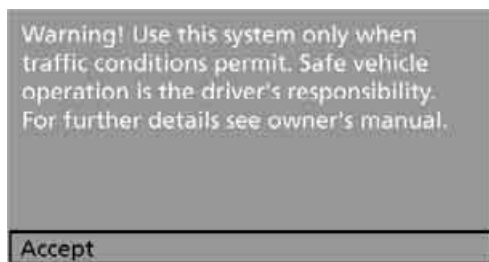

Confirm the message by pressing the controller; this opens the start menu.

## Start menu

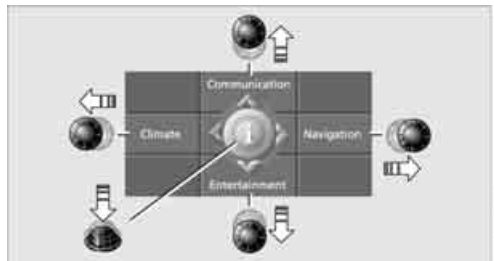

From the start menu, you can open four menus by moving the controller left, right, forward, or back. Pressing the controller opens the **i** menu.

### Opening start menu

Press the **MENU** button.

To open the start menu from the **i** menu:

Press the **MENU** button twice.

### Displays in menu

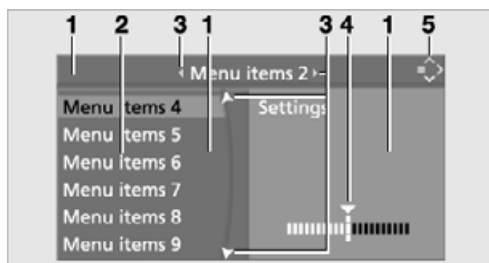

- 1 In menus, you can change fields to select the menu items they contain or to make adjustments. The respective current field appears brighter.
- 2 Menu items are usually grouped in horizontal or vertical lists.
- 3 Arrows indicate the possibility of accessing other menu items that are not currently visible.
- 4 Settings are displayed graphically, numerically, or as text.

5 A symbol indicates the last selected menu item of the start menu:



Communication



Navigation or onboard information



Entertainment



Climate



i menu

## Selecting menu items and making adjustments

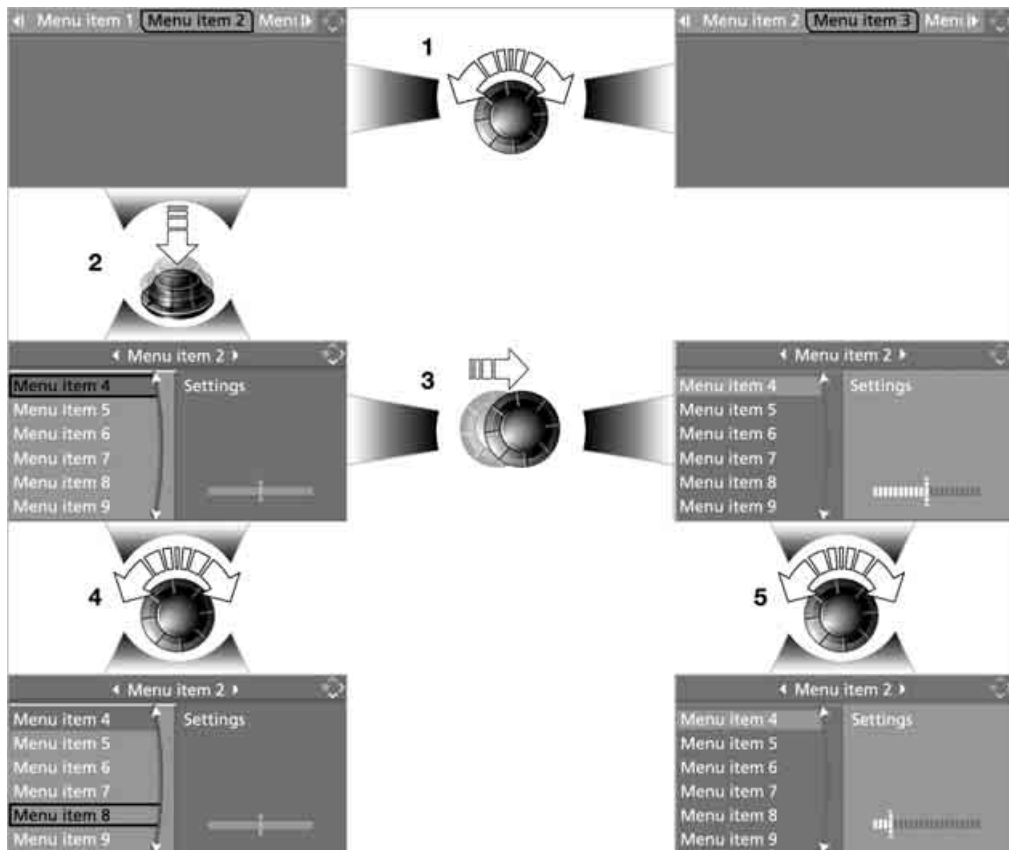

- 1 Selecting individual menu items: turn the controller. The highlight moves. Menu items shown in white can be selected.
- 2 Activating highlighted menu items: press the controller. New menu items are displayed or a function is carried out.
- 3 Changing the current field: move the controller to the left, right, forward or backward and let go.
- 4 Selecting menu items: such as 1.
- 5 Making adjustments: turn the controller. A graphical display, numerical values or text displays change. The setting is applied if you change to another field or into another menu.

### Changing directly to the last menu

Move the controller in the corresponding direction and hold it for longer than approx. 2 seconds. The menu in the selected direction is opened and the last menu item selected is displayed.

## Status information

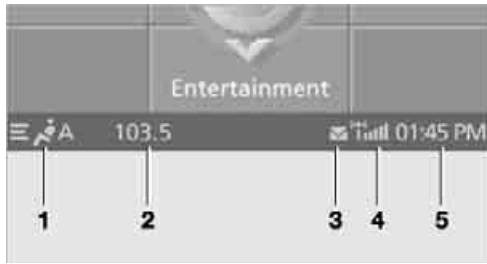

- 1 Display\* for manual or automatic air distribution on driver's side and passenger side
- 2 Display for:
  - ▷ Entertainment: Radio, CD or sound output for entertainment off.
  - ▷ Portable phone: "Car Phone", "Portable" or no network
- 3 Display for:
  - ▷ New entries are present in "Missed calls"\*
  - ▷ Text messages/SMS\* received
  - ▷ Roaming active
- 4 Phoning\* or BMW Assist calls\* are possible  
 Reception strength for telephone, depending on portable phone
- 5 Time

### Other displays:

When information of the Check Control appears or entries are made via the voice command system\*, the status information is temporarily hidden.

## Assistance window\*



Additional information can be displayed in the assistance window:

- ▷ The computer or the trip computer\*
- ▷ The route map or the arrow view in vehicles with a navigation system\*
- ▷ The current position

Switching on assistance window:

Move the controller to the right to change to the assistance window and press the controller.

To select the display in the assistance window:

1. Move the controller to the right to change to the assistance window and press the controller.

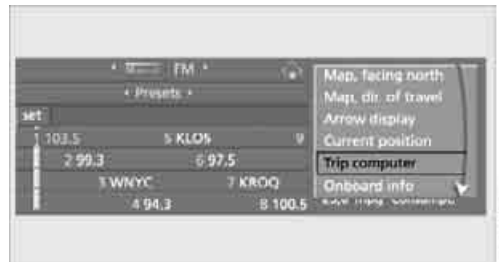

2. Select a menu item.
3. Press the controller.

Closing assistance window:

1. Move the controller to the right to change to the assistance window and press the controller.
2. Select "Assist. window off" and press the controller.



## Switching Control Display on/off

To switch off the Control Display:

1. Press the **MENU** button.  
This opens the start menu.
2. Press the controller to open the **i** menu.
3. Select "Display off" and press the controller.

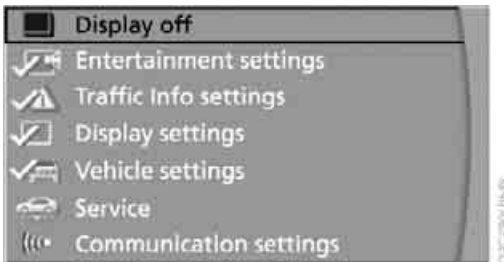

To switch on the Control Display:  
Press the controller.

# Voice command system\*

## The concept

The voice command system allows you to control operation of various vehicle systems without ever removing your hands from the steering wheel.

Individual menu items on the Control Display can be spoken as commands. This frees you of having to use the controller.

The voice command system transforms your oral commands into control signals for the selected systems and provides support in the form of instructions or questions.

The voice command system includes a special microphone.

The microphone is located:

- ▷ In the Coupe near the interior rearview mirror, refer to page 14
- ▷ In the Convertible on the steering column

## Precondition

In the Control Center, set the language that applies for the voice command system in order to enable identification of the spoken commands. For information on setting the language of the Control Center, refer to page 78.

## Symbol in the Owner's Manual

- ›...‹ Say the specified commands word for word.
- ››...‹‹ Indicates the responses of the voice command system.

## Voice commands

### Activating voice command system

1. Press the  button on the steering wheel or on the center console.



 This symbol on the Control Display and an acoustic signal indicate that the voice command system can respond to commands.



2. Say the command.  
Text or numbers that the voice command system has registered will appear on the Control Display.



 This symbol appears on the Control Display when you can input additional voice commands.

If no further voice commands are possible, operate the equipment using the Control Center.

## Terminating or canceling voice command system

Press the  button on the steering wheel or on the center console

or

 ›Cancel‹

## Voice commands

### Having the possible voice commands read aloud

You can have the system read aloud the possible voice commands related to the selected menu item on the Control Display. For example, if you have selected "CD", the system will read aloud possible voice commands for operating the CD player and the CD changer\*:

 ›Options‹

### Opening help

 ›Help‹

### Using alternative voice commands

There are often a number of commands to run a function, e.g.:

 ›Information menu‹ or ›i menu‹

### Calling up functions directly

With short commands you can carry out certain functions directly, regardless of which menu item is selected, refer to page 196.

## Opening the start menu

 ›Main menu‹

### An example: selecting a track

1. Press the  button in the steering wheel or on the center console.

 2. ›Entertainment‹  
The System outputs:  
››Entertainment‹‹



 3. ›CD‹  
The System outputs:  
››CD‹‹



 4. Select a track, e.g.:  
›Track 1‹  
The System outputs:  
››Track 1‹‹





## Notes



The portable phone can also be operated by voice commands, refer to page 156. ◀

For voice commands, bear the following in mind:

- ▷ Issue the commands fluently and at normal volume, avoiding excessive emphasis and pauses.
- ▷ Speak the names of radio stations in the language of the voice command system or use the pronunciation commonly used by the station.
- ▷ For entries in the voice-activated phone book, only use names in the language of the voice command system and no abbreviations.
- ▷ Keep the doors, windows and glass sunroof\* or convertible top closed to prevent interference from ambient noise.
- ▷ Avoid background noises in the vehicle while speaking.





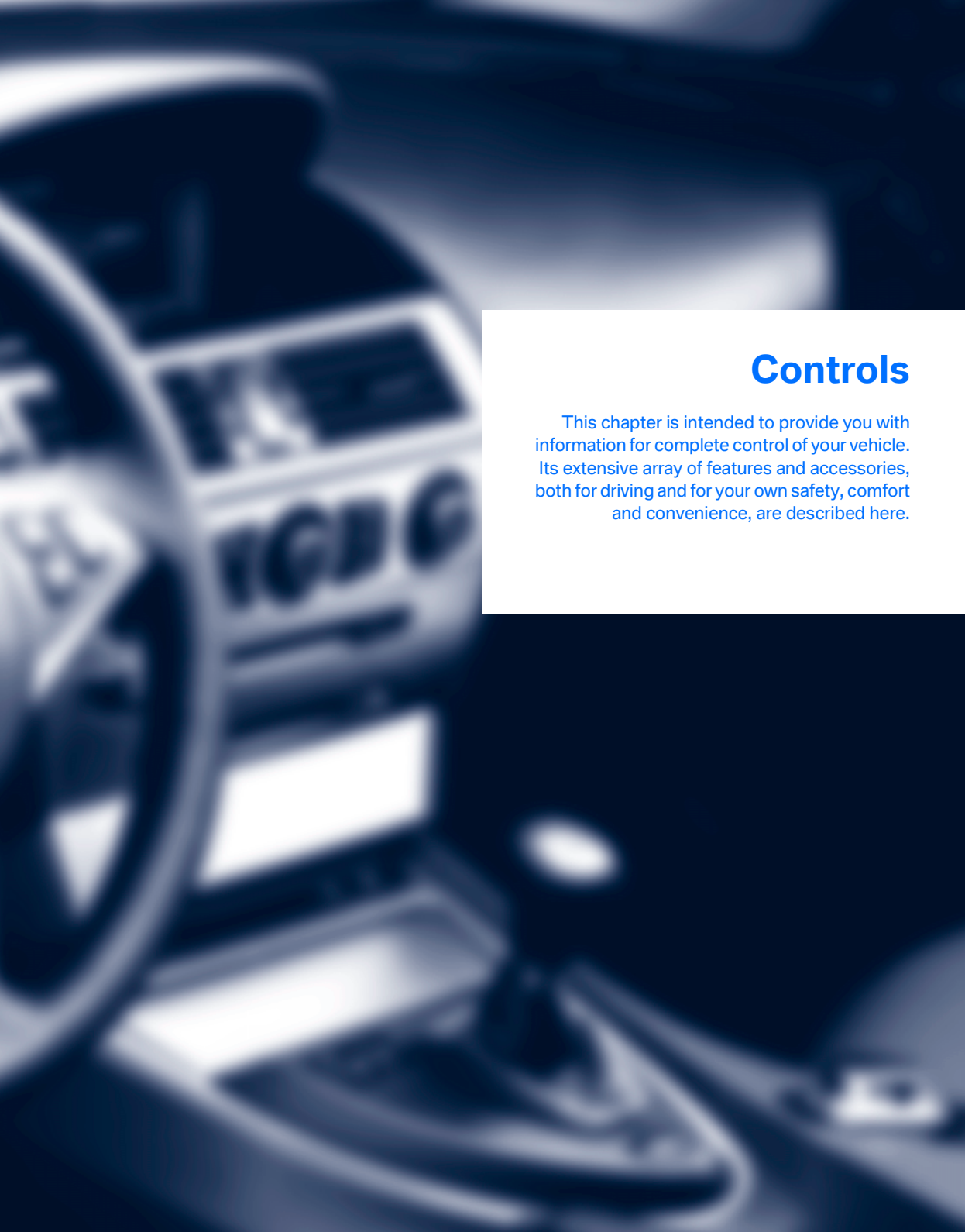

## Controls

This chapter is intended to provide you with information for complete control of your vehicle. Its extensive array of features and accessories, both for driving and for your own safety, comfort and convenience, are described here.

# Opening and closing

## The key set

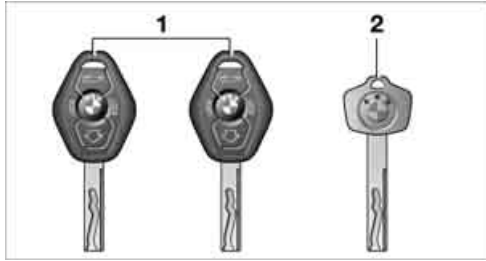

- 1 Every master key with remote control contains an extended-life battery as a power supply, which is charged automatically in the ignition lock as you drive. You should use each master key at least twice a year in order to maintain the charge condition. Depending on which master key is detected by the vehicle during unlocking, different settings in the vehicle are requested and executed, refer to Key Memory below.
- 2 Spare key for storage in a safe place, such as in your wallet. This key does not fit in the locks of the luggage compartment lid and the hotel function, refer to page 32. This is an advantage when valet parking at a hotel, for example. The key is not intended for constant use.

### New keys

New, additional or replacement keys are available at your BMW center.

## Key Memory

### How the system functions

Doubtless you have often reflected on how great it would be if you could configure your vehicle's various adjustment settings to meet your own personal requirements. BMW has designed several freely selectable options into the vehicle during its development. You can set these as desired via the Control Center.

You can have up to four different basic settings adjusted for four different persons for the specific keys. The only requirement is that each person uses his or her own master key with remote control.

When your vehicle is unlocked with the remote control, the vehicle recognizes the individual key by means of a data exchange and makes adjustments accordingly.

### Scope of Key Memory

- ▷ When unlocking with the remote control, either unlock only the driver's door or the entire vehicle, refer to page 29.
- ▷ Locking the vehicle after a short time or after starting to drive, refer to page 31
- ▷ Assigning the programmable function buttons on the steering wheel, refer to page 51.
- ▷ Settings for the display on the Control Display:
  - ▷ Brightness of the Control Display, refer to page 77
  - ▷ Units of measure for consumption, route/distances, temperature and pressure, refer to page 77
  - ▷ Language on the Control Display, refer to page 78
  - ▷ 12h/24h clock mode, refer to page 78
  - ▷ Date format, refer to page 79.
- ▷ Displaying optical warning for the PDC Park Distance Control\*, refer to page 80.
- ▷ Selection and brightness of the display for the Head-Up Display\*, refer to page 89.
- ▷ Air distribution, temperature and intensity for the automatic climate control, refer to page 96.
- ▷ Setting the language information for the destination guidance of the navigation system\*, refer to page 126.

The following settings mentioned last are also called up during unlocking:

- ▷ Driver's seat, exterior-mirror and steering-wheel position, refer to page 46
- ▷ The volume and tone settings for audio and video sources, refer to page 133
- ▷ The volume setting for the telephone, refer to page 151
- ▷ The display of the stored stations for the radio, refer to page 138

## Central locking system

### The concept

The central locking system is ready for operation whenever the driver's door is closed. This simultaneously engages and releases the locks on the following:

- ▷ Doors
- ▷ Compartment in the front center console
- ▷ Luggage compartment lid
- ▷ Fuel filler door

The central locking system can be operated from the outside

- ▷ via the remote control
- ▷ via the door lock

and from inside via the button for the central locking system.

If operated from the inside, the fuel filler door and the compartment in the front center console are not locked, refer to page 31.

The anti-theft system is automatically activated whenever you activate the central locking system from outside the vehicle. It prevents the doors from being unlocked using the lock buttons or door handles. The alarm system is armed/disarmed at the same time. The dome light is also switched on and off with the remote control.

You can find more detailed information on the alarm system on page 34.

In the event of a serious accident, the central locking system unlocks automatically. The hazard warning flashers and interior lamps also switch on.

## Opening and closing: from outside

### Using the remote control



 Protect the remote control against unauthorized use by handing over only the spare key, for example when using hotel valet parking. ◀

 Because any persons or animals left unattended in a parked vehicle could lock the doors from the inside, you should always keep the remote control with you; this precaution ensures that you will remain able to unlock the vehicle from the outside at all times. ◀

### Unlocking

Use the  button to unlock the vehicle depending on the setting.

Control Center, for principle details, refer to page 16.

1. Open the  menu.
2. Select "Vehicle settings" and press the controller.
3. Select "Door locks" and press the controller.
4. Select "Central locking" and press the controller.
5. Select "Unlock button" and press the controller.
6. Select a menu item:
  - ▷ "All doors"  
Press the  button once to unlock the entire vehicle.
  - ▷ "Driver's door only"  
Press the  button once to unlock only the driver's door and the fuel filler door.

Press the button twice to unlock the entire vehicle.



7. Press the controller.

The setting is stored for the remote control currently in use.

### Convenience opening mode

Hold the button down:

- ▷ Coupe: the windows are opened, the glass sunroof\* is raised, and the sliding panel moves back approx. 2 in/5 cm.
- ▷ Convertible: the windows and the convertible top are opened.



Watch the convertible top during the opening process to be sure that no one is injured. Releasing the button stops the operation. ◀

### Locking the doors

Press the LOCK button.

### Switching on the interior lamps

Press the LOCK button if the vehicle is locked. You can also use this function to locate your vehicle in parking garages etc.

### Panic mode\*

By pressing and holding the button for more than approx. 2 seconds, you can trigger the alarm system in response to any impending danger.

To switch off the alarm: press any of the buttons.

### Opening luggage compartment lid

Press the button.

The luggage compartment lid opens, regardless of whether it was previously locked or unlocked.



A previously locked luggage compartment lid is also locked after closing. Coupe: the luggage compartment lid swings to the rear and upward when opened. Make sure there is sufficient free space. ◀

### Setting confirmation signals

You can set confirmation signals to acknowledge the locking and unlocking of the vehicle. Control Center, for principle details, refer to page 16.

1. Open the menu.
2. Select "Vehicle settings" and press the controller.
3. Select "Door locks" and press the controller.
4. Select "Confirmation" and press the controller.



5. Select the desired signal.
6. Press the controller.
  - The signals are switched on.

### Malfunctions

Local radio waves can disrupt the function of the remote control.

Should the remote control fail to operate owing to interference of this kind, you can respond by using the master key to unlock your vehicle at one of the doors.

If it is no longer possible to lock the vehicle with a remote control, its battery is discharged. Use



this remote control during an extended drive; this will recharge the battery, refer to page 28.

### For US owners only

The transmitter and receiver units comply with part 15 of the FCC/Federal Communication Commission regulations. Operation is governed by the following:

FCC ID:  
LX8766S  
LX8766E  
LX8CAS

Compliance statement:

This device complies with part 15 of the FCC Rules. Operation is subject to the following two conditions:

- ▷ This device may not cause harmful interference, and
- ▷ this device must accept any interference received, including interference that may cause undesired operation.

 Any unauthorized modifications or changes to these devices could void the user's authority to operate this equipment. ◀

### Using door lock

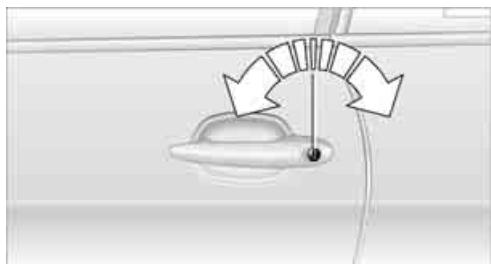

One turn of the key in the driver's door lock unlocks the driver's door only.

Turning the key a second time unlocks all of the remaining doors, the luggage compartment lid and the fuel filler door.

### Convenience operation

You can also use the door lock to operate the windows and the glass sunroof\* in the Coupe or to operate the windows and the top in the convertible.

- ▷ To open:  
With the door closed, turn the key to the Unlock position and hold it there.
- ▷ To close:  
With the door closed, turn the key to the Lock position and hold it there.

 Keep a close eye on the closing process and also on the opening process of the convertible top to be sure that no one is injured. Releasing the key stops the operation. ◀

### Manual operation

In the event of an electrical malfunction, you can turn the key all the way to the right or left in the door lock to lock or unlock the driver's door.

### Opening and closing: from inside



This button serves to unlock or lock doors and the luggage compartment lid, but does not activate the anti-theft system. The fuel filler door remains unlocked.

You can also make the following settings:

- ▷ The central locking system automatically locks the vehicle after a short time when no door has been opened.
- ▷ The central locking system automatically locks the vehicle as soon as you start to drive.

Control Center, for principle details, refer to page 16.

1. Open the **i** menu.
2. Select "Vehicle settings" and press the controller.



3. Select "Door locks" and press the controller.
4. Select "Central locking" and press the controller.



5. Select "Relock door if not opened" or "Lock after driving".
6. Press the controller.
  - The setting is selected.

The setting is stored for the remote control currently in use.

## Unlocking and opening the doors

- ▷ Either unlock both doors at the same time with the button for the central locking system and then pull the door handle above the armrest or
- ▷ pull the door handle for each door twice: the first pull unlocks the door, and the second one opens it.

## Locking the doors

- ▷ Use the central locking button to lock both of the doors simultaneously, or
- ▷ press down the lock button of the desired door. To prevent you from being locked out, the open driver's door cannot be locked using the lock button.

**!** Because any persons or animals left unattended in a parked vehicle could lock the doors from the inside, you should always keep the master key with remote control with you; this precaution ensures that you will remain able to unlock the vehicle from the outside at all times. ◀

## Hotel function

The hotel function locks the compartment in the front center console and the luggage compartment lid separately and disconnects them from the central locking system. The spare key, refer to page 28, does not fit the lock for the hotel function. If you then only hand over the spare key, e.g. at a hotel, it is not possible to access the luggage compartment or the compartment in the front center console.

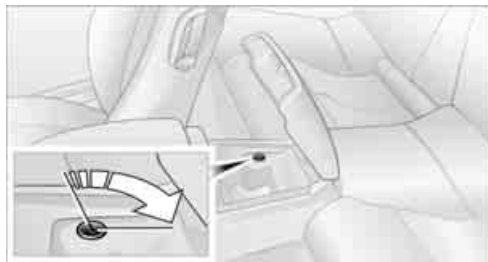

Turn the key to the right, refer to illustration, and remove.

The hotel function is only activated after subsequent locking or unlocking of the vehicle. This locks the luggage compartment lid and the compartment in the front center console and disconnects them from the central locking system.

## In the event of an electrical malfunction

For manual unlocking, turn the master key all the way to the right:

The compartment in the front center console is unlocked.

- ▷ If unlocking was manual, the lock has to be returned to the home position, i.e. all the way back to the left, before reactivation of the hotel function. ◀

## Luggage compartment lid

- ▷ Coupe: the luggage compartment lid swings to the rear and upward when opened. Make sure there is sufficient free space. ◀

## Opening from inside

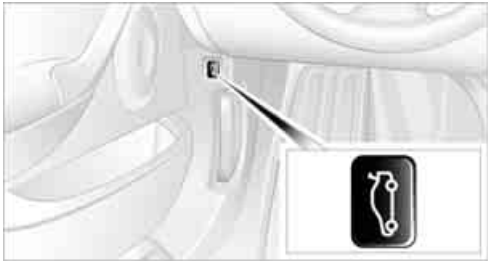

Press the button:  
The luggage compartment lid opens unless the hotel function is activated, see above.

## Opening from outside

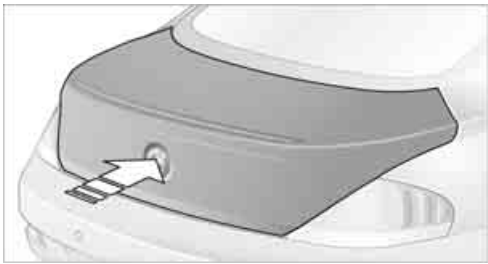

Press the upper half of the BMW emblem or the  button on the remote control:  
The luggage compartment lid opens.

 Convertible: if the opening or closing action is not completed, the luggage compartment lid cannot be opened, refer to page 40. ◀

## In the event of an electrical malfunction



The luggage compartment lid lock is located under the BMW emblem. Only the master keys with remote control, refer to page 28, match the luggage compartment lid lock.

Turn the master key to the right as far as it will go:

The luggage compartment lid opens.

 If you use the lock to unlock the luggage compartment lid while the alarm system is armed, the alarm will be triggered. Therefore, unlock the vehicle beforehand.

If the alarm has been triggered accidentally: Switching off the alarm, refer to page 34. ◀

## Emergency release



This lever releases the luggage compartment lid from inside the luggage compartment.

## Closing



The handle recesses on the interior trim of the luggage compartment lid make it easier to pull down.

 Make sure that the closing path of the luggage compartment lid is clear, as otherwise injuries may result.

Operate the vehicle only when the luggage compartment lid is completely closed. Otherwise, exhaust fumes could penetrate to the interior of the vehicle. ◀

If special circumstances should make it absolutely necessary to operate the vehicle with the luggage compartment lid open:

1. Coupe: close both windows and the glass sunroof\*.  
Convertible: with closed top, close all windows.
2. Increase the air volume of the automatic climate control to a high level, refer to page 95.

## Luggage compartment

There are four lashing eyes on the inner corners of the luggage compartment for securing luggage nets\* or securing straps to fix luggage in position.

Also refer to Securing cargo, page 111.

### Convertible: increasing luggage compartment capacity

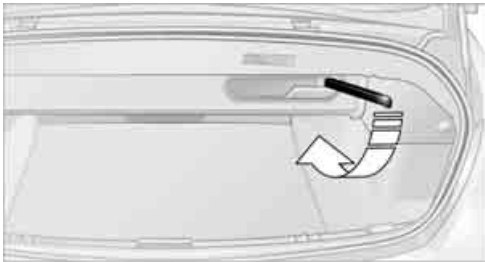

With the convertible top closed, you can enlarge the luggage compartment capacity: To do so, unfold the handle and press it downward in the direction of travel, refer to arrow. This folds the convertible top compartment floor upward.

Before opening the convertible top, execute this procedure in reverse order.

- ▶ The convertible top cannot be opened if the convertible top compartment floor is folded up.◀

## Alarm system

### The concept

The vehicle alarm system responds:

- ▶ To the opening of doors, the hood, or the luggage compartment lid
- ▶ To movements in the vehicle interior: interior motion sensor, see below
- ▶ To changes in the vehicle's tilt if someone attempts to steal the wheels or tow the vehicle
- ▶ To interruptions in battery voltage

The system responds to unauthorized vehicle entry and attempted theft by simultaneously activating:

- ▶ An acoustic alarm, which lasts for a period of approx. 30 seconds
- ▶ The hazard warning flashers for approx. 5 minutes
- ▶ The high beams, which flash on and off in the same rhythm

### Arming and disarming alarm system

When you lock or unlock the vehicle, either with the remote control or at the door lock, the alarm system is armed or disarmed at the same time.

The system indicates that it has been correctly armed by switching on the hazard warning flashers for a single cycle and by emitting an acoustic signal.

You can also open the luggage compartment lid with the system armed using the  button on the remote control, refer to page 30. When the luggage compartment lid is closed, it is locked again and monitored.

### Switching off alarm

- ▶ Unlock the vehicle using the remote control, refer to page 29,
- ▶ or turn the ignition key to position 1, refer to page 54.

## Indicator lamp displays



- ▷ The indicator lamp below the interior rearview mirror flashes continuously: the system is armed.
- ▷ The indicator lamp flashes after locking: door(s) or luggage compartment lid are not completely closed. Even if you do not close the alerted area, the system begins to monitor the remaining areas, and the indicator lamp flashes continuously after approx. 10 seconds. However, the interior motion sensor is not activated.
- ▷ The indicator lamp goes out after unlocking: no manipulation or attempted intrusions have been detected in the period since the system was armed.
- ▷ After unlocking, the indicator lamp flashes until the key is inserted into the ignition lock, but will not do so for longer than roughly 5 minutes: an attempted entry has been detected in the period since the system was armed.

## Tilt alarm sensor and interior motion sensor

### Tilt alarm sensor

Monitors the inclination of the vehicle. The alarm system reacts, for example, if someone attempts to steal the wheels or tow the vehicle.

### Interior motion sensor

Coupe:

In order for the interior motion sensor to function properly, the windows and glass sunroof\* must be completely closed.

Convertible:

Monitors the interior up to the height of the seat cushions. This means that the alarm system, including the interior motion sensor, is armed even if the convertible top is open. Falling objects, e.g. leaves, can trigger false alarms, refer to Avoiding unintentional alarms.

## Avoiding unintentional alarms

The tilt alarm sensor and interior motion sensor may be switched off at the same time. This prevents unintentional alarms, e.g. in the following situations:

- ▷ In stacking garages
- ▷ When transporting on car-carrying trains
- ▷ When animals are to remain in the vehicle

## Switching off the tilt alarm sensor and interior motion sensor

Press the  LOCK button on the remote control once again directly after locking.

The indicator lamp lights up briefly and then flashes continuously. The tilt alarm sensor and the interior motion sensor are switched off until the vehicle is unlocked and locked again.

## Windows



To prevent injuries, exercise care when closing the windows and keep them in your field of vision until they are shut.

When leaving the vehicle, always remove the ignition key and close the doors to prevent children from operating the power windows and injuring themselves. ◀

## Coupe: opening and closing windows



Ignition key in position 1 or greater, refer to page 54:

- ▷ Press the switch up to the resistance point: The window continues to open for as long as you hold the switch.
- ▷ Briefly press the switch beyond the resistance point: The window opens automatically. Briefly press the switch again to stop the opening movement.

You can close the windows in the same manner by pulling the switch.

## Convertible: opening and closing windows

 To close the side windows while the vehicle is being driven, always close the rear windows first or all four windows simultaneously, as otherwise the windows cannot close tightly at higher speeds. ◀

### Individually



Ignition key in position 1 or greater, refer to page 54:

- ▷ Press the switch up to the resistance point: The window opens as long as you continue to hold the switch.

- ▷ Briefly press the switch beyond the resistance point: The window opens automatically. Briefly press the switch again to stop the opening movement.

You can close the windows in the same manner by pulling the switch. The rear windows cannot be closed automatically with one touch.

### Together



Ignition key in position 1 or greater, refer to page 54:

1. Briefly press button 1: The LEDs in button 1 and switch 2 light up.
2. Press switch 2:
  - ▷ Up to the resistance point: All windows continue to open for as long as you hold the switch. You can close the windows in the same manner by pulling the switch.
  - ▷ Briefly press the switch beyond the resistance point: All windows open automatically. Briefly press the switch again to stop the opening movement.

Briefly press button 1 again to deactivate the function. The LEDs go out.

## Rear window



Ignition key in position 1 or greater, refer to page 54:

1. Briefly press button 1:  
The LEDs in button 1 and switch 2 light up.
2. Press switch 2:
  - ▶ Up to the resistance point:  
The rear window continues to open for as long as you hold the switch. You can close the rear window in the same manner by pulling the switch.
  - ▶ Briefly press the switch beyond the resistance point:  
The rear window opens automatically. Briefly press the switch again to stop the opening movement.

Briefly press button 1 again to deactivate the function. The LEDs go out.

 The rear window opens and closes automatically when you open or close the convertible top. ◀

## After switching off ignition

You can still operate the windows:

- ▶ for approx. 15 minutes when the ignition key is in position 1.
- ▶ for approx. 1 minute when the ignition key is in position 0 or has been removed; but in the convertible, only for as long as a door has not been opened.

For information on using the convenience operation mode at the door lock or with the remote control, refer to page 30 or 31.

## Anti-trapping mechanism

If the closing force rises beyond a predefined threshold during closing, the system will immediately stop moving the window prior to lowering it slightly.

 Convertible: the back windows and rear window are not equipped with an anti-trapping mechanism. ◀

 Despite the anti-trapping mechanism, you should inspect the travel path of the front side window prior to closing it, as the safety feature could fail to detect certain kinds of obstructions, such as very thin objects, and the window would continue closing. Pulling the switch beyond the resistance point and holding it limits the response of the anti-trapping mechanism. Under these conditions, the window will respond to forces beyond a defined threshold by only opening a few inches/millimeters.

If you pull the switch past the resistance point again within approx. 4 seconds and hold it there, the anti-trapping mechanism will be deactivated. ◀

## Accessories in window area

After installing any accessory – such as a clamp-on antenna for a portable phone – within the window's travel range, you will need to have the system reinitialized for use under the new conditions. Please contact your BMW center for assistance.

## Coupe: Glass sunroof, electric with raise function\*

 To prevent injuries, exercise care when closing the glass sunroof and keep it in your field of vision until it is shut. When leaving the vehicle, always remove the key and close the doors, as otherwise children could operate the sunroof and injure themselves. ◀

## Raising and closing glass sunroof



Ignition key in position 1 or greater, refer to page 54:

- ▷ Briefly press the switch:  
The sunroof opens and the sliding visor moves back approx. 2 in/5 cm or  
press the switch twice past the resistance point toward the rear:  
The sunroof opens and the sliding panel moves completely back.
- ▷ To close, briefly press the switch or push it twice beyond the resistance point toward the front:  
The sunroof and sliding panel close.

## Opening and closing sliding panel

Ignition key in position 1 or greater, refer to page 54:

- ▷ Push the switch up to the resistance point in the desired direction:  
The sliding panel continues to move for as long as you hold the switch.
- ▷ Push the switch beyond the resistance point in the desired direction:  
The sliding panel moves automatically. Briefly press the switch again in any direction to stop the movement.

## After switching off ignition

You can still operate the sunroof:

- ▷ for approx. 15 minutes when the ignition key is in position 1.
- ▷ for approx. 1 minute in position 0 or with the ignition key removed, as long as a door has not been opened.

For information on using the convenience operation mode at the door lock or with the remote control, refer to page 30 or 31.

## Anti-trapping mechanism

If the glass sunroof encounters resistance when closing, the closing action is interrupted and the glass sunroof opens.

If the sliding panel encounters resistance when closing within the last approx. 8 in/20 cm, the closing action is interrupted and the sliding panel opens again slightly.

- ⚠ Despite the anti-trapping mechanism, you should inspect the sunroof's travel range prior to closing it, as the safety feature might fail to detect certain kinds of obstructions, such as very thin objects, and the sunroof would continue closing. Pressing the switch beyond the resistance point and holding it deactivates the anti-trapping mechanism. ◀

## Following interruptions in electrical power supply

After an interruption in the power supply the glass sunroof may not move. The system has to be initialized. Should this occur, please have the sunroof initialized at your BMW center.

## Moving manually

In the event of an electrical malfunction, you can move the panorama glass sunroof and the sliding panel manually.

## Glass sunroof

1. Remove cover on headliner in front of rear window. To do so, lift slightly, arrows 1.



Grasp behind the cover, arrows **2** and pull firmly downward.

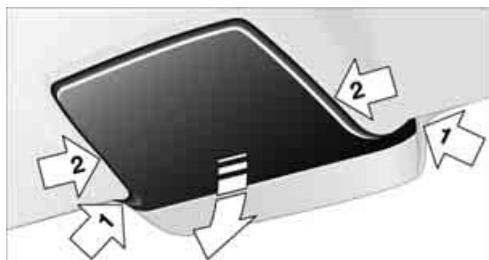

2. Insert Allen wrench from on-board tool kit, refer to page 180, into the opening provided.



3. Use the Allen wrench to move the glass sunroof in the desired direction.

### Sliding panel

1. Fold the cover downward, if necessary using the screwdriver from the onboard tool kit, refer to page 180.



2. Insert the Allen wrench supplied with the onboard tool kit in the opening provided.



3. Use the Allen wrench to move the sliding visor in the desired direction.

### Convertible: top

The fully automatic convertible top combines secure weather protection with simple and convenient operation.

So that you get the maximum pleasure from your convertible, here are a few tips:

- ▶ It is advisable to close the convertible top when the vehicle is parked. The closed convertible top not only protects the passenger compartment against unforeseen weather damage, it also provides a certain amount of protection against theft. Nonetheless, even if the convertible top is closed, only keep valuables in the locked luggage compartment.
- ▶ Do not attach luggage rack systems to the convertible top.

**⚠** In order to avoid damage, do not operate the convertible top at temperatures below +14 °F / -10 °C.

Do not leave the convertible top in its storage compartment for longer than one day when wet, as otherwise damage from moisture can occur. Do not place any objects on the convertible top, as otherwise if the top were to be operated, these objects could fall off and lead to damage or injury.

Never move the convertible top when the roll-over protection system is raised.

Driving without having completed the opening or closing action can lead to damage or injury. Do not place hands in the top mechanism during the opening and closing action. Keep chil-



dren away from the travel path of the convertible top.  
For safety reasons, only operate the convertible top when the vehicle is at a standstill. ◀

▶ If you have initiated top operation with the vehicle at a stop and then start to drive, e.g. at a traffic light, you can continue the initiated operation up to a speed of 20 mph/30 km/h:

To do so, press and hold the corresponding button. ◀

▶ Partial vacuums that occur at higher speeds in the passenger compartment can make the convertible top flap. Use the automatic climate control to increase the air supply so that a partial vacuum in the vehicle does not occur. ◀

## Prior to opening and closing

- ▶ Read carefully and comply with the safety precautions that appear above.
- ▶ Ensure that the convertible top compartment floor in the luggage compartment is folded down, refer to page 34, as otherwise the convertible top cannot be opened.
- ▶ Ensure that the luggage compartment lid is closed.

## Opening and closing

With the ignition key in position 1 or greater, refer to page 54, and the vehicle stationary:

▶ So as not to place an excessive load on the battery, only operate the convertible top with the engine running, if possible.  
Before closing the convertible top, remove foreign bodies from the windshield frame, as these might inhibit closing of the convertible top. ◀



- 1 Closing
- 2 LED
- 3 Opening

▶ When the button for top operation is pressed, the side windows move downward slightly; the rear window is lowered completely.

If you hold down the button after the LED 2 goes out, the windows are raised again.

If the opening or closing action is not completed, the luggage compartment lid cannot be opened. ◀

## LED

In the following situations, in addition to the LED, a message is displayed on the Control Display and an acoustic signal may sound:

- ▶ During convertible top operation, the LED lights up green. It goes out as soon as the opening or closing action is ended.
- ▶ If the LED flashes red when you release the button, the opening or closing action has not yet finished.
- ▶ If the LED lights up red when the button is pressed, either the floor of the convertible top storage compartment in the luggage compartment is in the raised position or a malfunction has occurred. The convertible top cannot be moved.

## Interruption

The automatic sequence of movements is interrupted immediately if the button for top operation is released. The sequence can be continued in the desired direction using the button.

If the opening or closing action is interrupted for a longer period, the convertible top remains in that position for approx. 15 minutes before it slowly moves to a stable position.

⚠ A convertible top which is not completely opened or closed presents a danger. Do not interrupt and continue the closing action several times in succession, as otherwise the top mechanism can be damaged. ◀

 If the opening or closing action is not completed, the luggage compartment lid cannot be opened. ◀

### Convenience operation with the remote control and via the door lock

Refer to pages 30 and 31.

### Manual closing in the event of an electrical malfunction

 Only close the convertible top manually if absolutely necessary; never open it manually. The convertible top compartment lid cannot be locked in the event of an electrical malfunction and would open while the vehicle is being driven. Improper handling can lead to damage. ◀

#### Before closing

1. Open the luggage compartment lid.
2. Take the Allen wrench and the screwdriver from the on-board tool kit, refer to page 180.
3. Lever out the two buttons in the luggage compartment with the screwdriver and then pull firmly. The convertible top compartment lid is unlocked.



4. Close the luggage compartment lid.

 During manual convertible top operation, the luggage compartment lid cannot be opened. ◀

5. Completely open the side windows and the rear window.  
If the rear window cannot be opened using the switch, it must be lowered manually.

### Opening rear window manually

1. Lever out the cover between the rear head restraints. To do so, place the screwdriver as close as possible to the lock elements, as shown in the illustration.



2. Insert the Allen wrench as far as possible in the opening and turn firmly in the direction indicated by the arrow until the rear window is completely open.

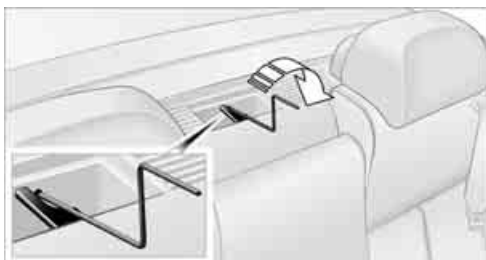

### Closing

 Perform the following work steps with the assistance of a second person and with the doors open to prevent injury and damage to the convertible top. ◀

1. Push the cover **1** on the left and right of the side panel forward. Reach into the resulting openings and raise the convertible top compartment lid **2** as far as it will go.

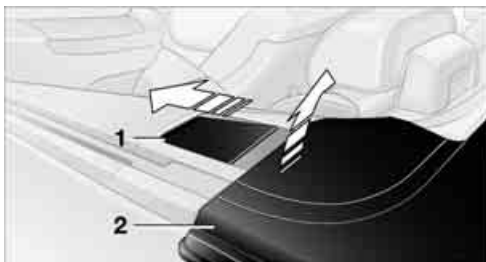

- Grasp the top with both hands at the left and right side frame, arrow 3.



Lifting the convertible top at parts other than the side frame can damage it. ◀



- Both persons lift on both sides simultaneously and swing the top forward. In doing so, keep the convertible top compartment lid open, arrow 4, e.g. with your shoulder.



- Raise the two convertible top ends as far as they will go, arrow 5, and close the convertible top-compartment lid, arrow 6.



Do not raise the convertible top ends until after the convertible top has been swung forward, as otherwise damage can occur. ◀



- Fold down the top ends onto the convertible-top compartment lid.

- From the interior, take out the cover in the center of the front top frame; use a screwdriver if necessary.
- Insert the Allen wrench into the opening provided.



- From the outside, both persons pull the front frame of the convertible top downward, as simultaneously as possible on the two sides.
- Turn the Allen wrench in the direction of the arrow until the front convertible top frame locks to the windshield frame. The rear convertible top ends are pressed automatically onto the convertible top compartment lid and close tightly with tension.
- If necessary, close the rear window again manually in the same way as above.

## Wind deflector\*

The wind deflector keeps the air movement in the passenger compartment at a low level when the convertible top is open, thus enabling pleasant driving even at higher speeds. You can conveniently stow it in the luggage compartment when it is not needed.

## Before installing

1. Remove the wind deflector from the protective sleeve and fold it open.
2. Press the upper and lower section together until the locking device engages.



3. Push out the securing pin 1 out until it engages.

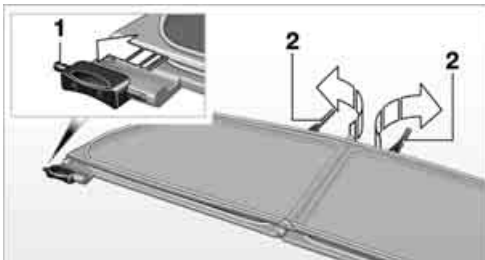

4. Unfold the rear mounts 2.

## Installing

1. Insert the securing pin 1 of the wind deflector into the appropriate opening on the right side of the vehicle.

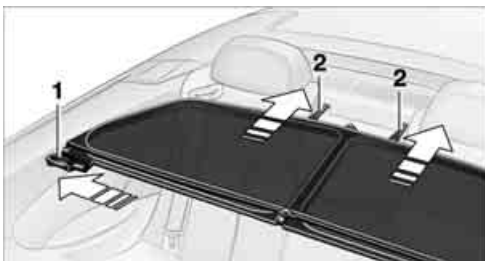

2. Guide the rear mounts 2 into the receptacles provided.

3. Push the securing pin 3 on the left side until it snaps into place in the appropriate opening.

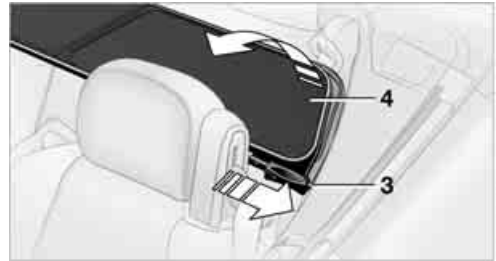

4. Fold up the upper half 4 of the wind deflector.

**!** With wind deflector fitted: do not incline the front seat backrests too far backward if the seat is to be moved back to the end position, as otherwise the wind deflector will be damaged. ◀

## Removing

The same as installing, but in reverse order.

## Folding up

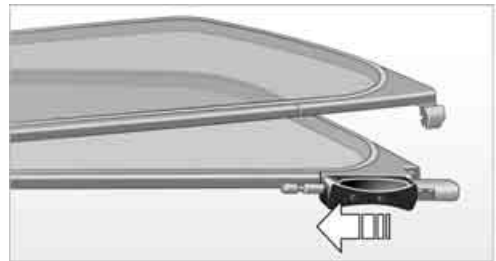

1. Push the handle of the securing pin on the wind deflector on the left side of the vehicle all the way back and release the locking mechanism.
2. Fold in the upper and lower section.

# Adjustments

## Sitting safely

The ideal sitting position can make a vital contribution to relaxed, fatigue-free driving. The sitting position also plays an important role together with the safety belts and airbags in providing occupants with maximum levels of passive safety in an accident. To ensure that the safety systems operate with optimal efficiency, we strongly urge you to observe the instructions contained in the following section. For additional information on transporting children safely, refer to page 52.

## Airbags

 Always maintain an adequate distance between yourself and the airbags. Always hold the steering wheel by its rim with hands at the 9 o'clock and 3 o'clock positions, to minimize the risk of injuries to your hands and arms in the event of airbag deployment. No one and nothing is to come between the airbags and the seat occupant. Do not use the cover of the front airbag on the front passenger side as a storage area. Make sure that the front passenger is sitting correctly and does not rest feet or legs on the instrument panel, otherwise leg injuries can occur if the knee and front airbags are triggered. Never let an occupant's head rest near or on a side airbag because the inflating airbag could cause a serious or fatal injury. ◀

Even if you adhere to all the instructions, injuries resulting from contact with airbags cannot be fully excluded, depending on the circumstances. The ignition and inflation noise may provoke a mild hearing loss in extremely sensitive individuals. This effect is usually only temporary.

For airbag locations and additional information on airbags, refer to page 86.

## Safety belt

Fasten your safety belt before starting any trip. Airbags complement the safety belt as an additional safety device, but they do not represent a substitute.

Your vehicle has four seats that are all equipped with a safety belt.

 At all times, occupants should sit upright and be properly restrained: infants and small children in appropriate child-restraint systems; larger children and adults using the safety belts.

Never allow more than one person to wear a single safety belt. Never allow infants or small children to ride in a passenger's lap.

Expectant mothers should always wear their safety belts, taking care to position the lap belt against the lower hips, where it will not exert pressure against the abdominal area.

Do not route the belt across your neck, or run it across sharp edges. Be sure that the belt does not become caught or jammed. Avoid twisting the belt while routing it firmly across the hips and shoulder. Do not allow the belt to rest against hard or fragile objects. Otherwise, in the event of a frontal impact, a loose lap belt could slide over your hips, leading to abdominal injury. Avoid wearing clothing that prevents the belt from fitting properly and pull the shoulder belt periodically to readjust the tension across your lap in order to avoid a reduction in the retention effect of the safety belt. ◀

For instructions on operating safety belts, refer to page 48.

## Seats

### Note before adjusting

 Never attempt to adjust your seat while operating the vehicle. The seat could respond with unexpected movement, and the ensuing loss of vehicle control could lead to an accident.

On the front passenger side as well, do not tilt the backrest too far toward the rear. Failure to observe this precaution can prevent the belt from providing effective protection against injury, as the passenger could slide under the belt in an accident.

Make sure that the footwell behind the driver's and front passenger's seat is empty and unobstructed. If you fail to do so, any persons or objects behind the seat could be injured or damaged by a rearward movement of the seat. ◀

Also observe the instructions regarding damage to the safety belt on page 49.

**⚠** Convertible: with the wind deflector fitted, do not incline the front seat backrests too far backward if the seat is to be moved back to the end position, as otherwise the wind deflector will be damaged. ◀

## Seat adjustment

**⚠** To ensure that the safety systems continue to provide optimized protection, please observe the adjustment instructions above. ◀



- 1 Inclination
- 2 Longitudinal direction
- 3 Height
- 4 Backrest
- 5 Convertible: head restraints, refer to page 47

With the sports seat\*, you can also adjust the high support manually:

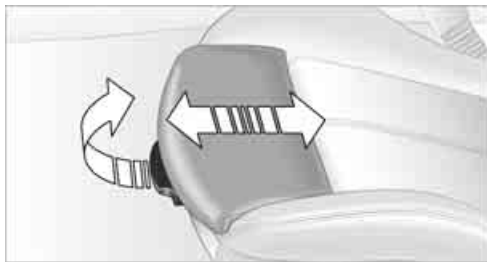

Pull the lever and move the thigh support in a longitudinal direction.

## Lumbar support\* adjustment



You can also adjust the contours of the backrest to obtain additional support in the lumbar region.

The upper hips and spinal column receive supplementary support to help you maintain a relaxed, upright sitting position.

- ▷ Increase or decrease curvature: Press front or rear of switch.
- ▷ Move curvature up or down: Press top or bottom of switch.

## Seat, mirror and steering wheel memory



You can store and select three different adjustment settings for the driver's seat, exterior mirrors and steering wheel.

The adjustment of the lumbar support is not stored in the memory.

### Storing

1. Turn ignition key to position 1 or 2, refer to page 54.
2. Adjust the desired seat, exterior mirror and steering-wheel positions.
3. Press the **M** button:  
The indicator lamp in the button lights up.
4. Press the desired memory button **1**, **2** or **3**:  
The indicator lamp goes out.

### Requesting

 Do not request a position from the memory while the vehicle is moving. There is a risk of accident from unexpected movement of the seat or steering wheel. ◀

### Convenience mode

1. Open the driver's door after unlocking or turn the ignition key to position 1, refer to page 54.
2. Briefly press the desired memory button **1**, **2** or **3**.

The system immediately cancels the adjustment procedure when you briefly press one of the seat adjustment switches or one of the memory buttons.

The adjusting procedure for the steering wheel is immediately interrupted if you operate the switch for the steering wheel adjustment in any direction, refer to page 50.

### Safety feature

1. Close the driver's door and turn the ignition key to position 0 or 2, refer to page 54.
2. Press the desired memory button **1**, **2** or **3** and maintain pressure until the adjustment process has been completed.

If the **M** button was pressed inadvertently: Press the button again; the indicator lamp goes out.

### Position stored in key

The positions of the driver's seat, the external rearview mirrors, and steering wheel are stored for the remote key currently in use.

You can choose when the position is requested:

- ▷ Request when unlocking vehicle
- ▷ Request when opening driver's door

Control Center, for principle details, refer to page 16.

1. Open the  menu.
2. Select "Vehicle settings" and press the controller.
3. Select "Door locks" and press the controller.
4. Select "Central locking" and press the controller.
5. Select "Last seat pos." and press the controller.
6. Select "After unlocking" or "After opening door" and press the controller.





To cancel the request:  
Select "Deactivated" and press the controller.

**!** When using this function, always make sure that the footwell behind the driver's seat is empty and unobstructed. Failure to do so could cause injury or damage to persons or objects behind the seat as a result of a rearward movement of the seat. ◀

## Tilt function, passenger-side mirror

Automatic curb monitor



### Activating

1. Slide mirror selector into the driver's side mirror position.
2. When you engage reverse gear or selector-lever position R, the exterior mirror glass on the front passenger side tilts downward slightly. This allows the driver to see the area immediately adjacent to the vehicle – such as a curb – when parking, etc.

### Deactivating

Slide the mirror selection switch to the passenger's side position.

## Front head restraints

**!** Head restraints reduce the risk of spinal injury in the event of an accident. Adjust the head restraints so that they are centered roughly at the level of your ears. ◀

## Coupe

### Adjusting height



- ▷ To raise: pull the head restraint upward.
  - ▷ To lower: slide the head restraint downward.
- ▷** To reach the lowest position, press the button, refer to arrow 1. ◀

### Adjusting tilt angle

Swivel the head restraints.

### Removal

1. Pull the head restraint upward to the stop.
2. Press the button, arrow 1, and remove the head restraint.

### Installation

Insert head restraint into the sockets and adjust.

### Convertible

### Adjusting height

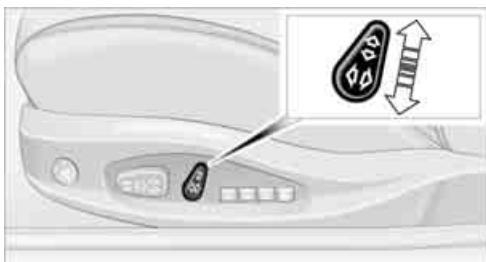

- ▷ To raise: move the switch upward.
- ▷ To lower: move the switch downward.



## Adjusting tilt angle

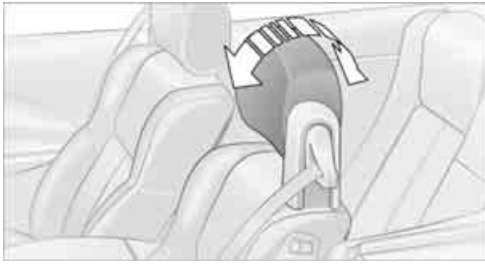

Swivel the head restraints.

## Entry to the rear

**⚠** Before starting to drive, fold backrests back, otherwise there is the danger of accident due to an unexpected movement of the seat. ◀

## Coupe: releasing backrest

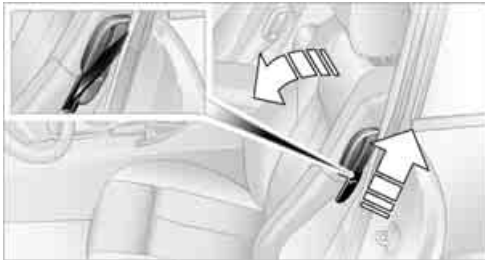

Pull the lever upward and fold the backrest forward.

The lever is designed in such a way that the safety belt can be stored there. This enables you to fasten the safety belt more conveniently.

## Convertible: releasing backrest

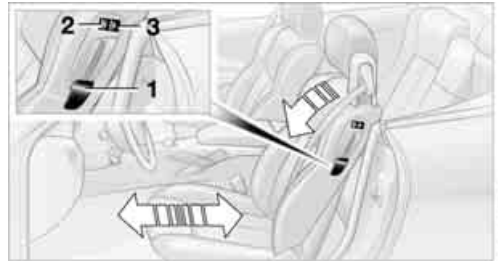

The belt system integrated into the seat ensures easier entry into the rear.

1. Pull the lever **1** upward and fold the backrest forward.
2. Press and hold button **2** until the seat has moved to the desired position.
3. After entry to the rear, fold back the backrest and lock it in place.
4. Press and hold button **3**. The seat moves back to its previous position. If you release button **3** before this, the seat stops in its current position.

**▷** You can lock the backrest in place when it is folded forward. This is useful, for example, when you get into the vehicle when it is parked on a hill. Press the backrest until it audibly locks into place. To fold it back, you do not have to use lever **1** to release it. ◀

**🔒** Lock backrest warning lamp: Lights up when the backrest is not locked. At the same time, an additional message appears on the Control Display.

## Safety belts

**⚠** To ensure that the safety systems continue to provide optimized protection, please observe the adjustment instructions on page 44. ◀

Before every drive, make sure that safety belts are being worn at all of the occupied seats. Airbags complement the safety belt as an additional safety device, but they do not represent a substitute.



## Fastening

Make sure you hear the latch plate engage in the belt buckle.

## Releasing

1. Hold the belt firmly.
2. Press the red button in the belt buckle.
3. Guide the belt into its reel.

The shoulder strap's anchorage point will be in the correct position for adults of every build if the seat is correctly adjusted, refer to page 44.

## Safety belt reminder for driver's seat and passenger seat\*



The indicator lamp lights up and a signal sounds. A message also appears on the Control Display. Please check

whether safety belts are being worn correctly.

The safety belt reminder is operative at speeds above approx. 5 mph/8 km/h. It can also be activated if objects are placed onto the passenger seat.

## Damage to safety belts



If the safety belts are damaged or stretched in an accident: have the entire belt system, including the tensioning mechanisms, replaced at your BMW center. Have the belt anchorage points inspected for damage at the same time. Failure to observe this precaution may prevent the safety belts from effectively providing optimal protection when needed. ◀

## Heated seats



The temperature setting progresses one step through its control sequence each time you press the button. Maximum preselected temperature with three lamps.

To switch off: press the button longer.

## Mirrors

### Adjusting exterior mirrors



The mirror on the passenger's side features a lens with a more convex surface than the mirror installed on the driver's side. When estimating the distance between yourself and other traffic, bear in mind that the objects reflected in the mirror are closer than they appear. This means that estimations of the distance to following traffic should not be regarded as precise. ◀



- 1 Adjustments
- 2 Switching over to the respective other mirror or to the automatic parking function, refer to Tilting down passenger's mirror, page 47

Storing the mirror positions, refer to Seat, mirror and steering wheel memory, page 46.

### Adjusting manually

You can also adjust the mirrors manually if necessary by pressing against the edges of the mirror glass.

### Outside mirrors, folding in and out

 To prevent the exterior mirrors from being damaged due to the width of the vehicle, always fold them in by hand before entering an automatic car wash. ◀

### Automatic functions

- ▷ Both exterior mirrors are automatically heated in ignition key position 2.
- ▷ When the vehicle is moving forward, the interior and exterior mirrors dim as a function of the incoming light\*.

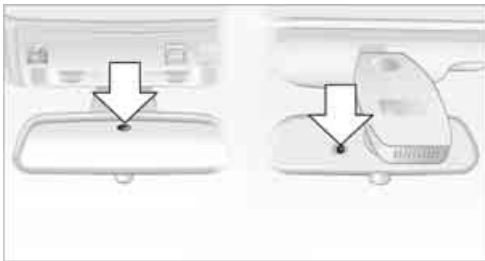

There are two photocells in the interior mirror to control the automatic dimming of the interior

mirror. One is integrated into the mirror glass, refer to arrow, while the other is located at a position slightly offset from this on the rear of the mirror housing.

For trouble-free operation, keep the photocells clean and do not cover the area between the interior rearview mirror and the windshield. Also do not attach stickers to the windshield in front of the mirror.

## Steering wheel

### Adjustments

 Do not adjust the steering wheel while the vehicle is moving. There is a risk of accident from unexpected movement of the steering wheel. ◀

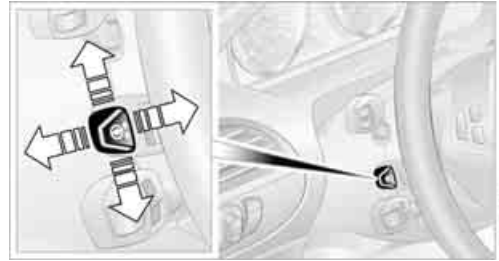

The steering wheel can be adjusted in four directions.

Storing the steering-wheel position, refer to Seat, mirror and steering wheel memory, page 46.

### Easy entry/exit

To make it easier to enter and exit the vehicle, the steering wheel temporarily moves into the uppermost position.

## Steering wheel heater\*



In ignition key position 2, press the button. The indicator lamp in the button lights up when the steering wheel heater is switched on.

## Programmable buttons on steering wheel



You can assign functions to the buttons individually:

Control Center, for principle details, refer to page 16.

1. Open the **i** menu.
2. Select "Vehicle settings" and press the controller.
3. Select "Steering wheel buttons" and press the controller.



The different functions are displayed:

- ▷ "Nav. voice instructions"  
Voice instructions for the navigation system
  - ▷ "Air recirculation on / off"  
Continuously shut off the supply of outside air, refer to AUC Automatic recirculated-air control on page 95
  - ▷ "Mute on / off"  
Mute the audio sources
  - ▷ "Monitor on / off"  
Switch the Control Display on/off
  - ▷ "Telephone list"  
Switch between Entertainment and Telephone
  - ▷ "Next entertainment source"  
Change audio source
4. Select the desired function.
  5. Press the controller.
  6. Select button if necessary.



7. Press the controller.

The setting is stored for the remote control currently in use.

You can operate the selected function using the corresponding button.

## Operating function

Press the corresponding button on the steering wheel.

Voice instructions of navigation system:

- ▷ To switch voice instructions on/off:  
Maintain pressure on the button for several seconds.
- ▷ To repeat the last voice instruction:  
Press button.

# Transporting children safely

## The right place for children

### Children always in the rear

Accident research shows that the safest place for children in a vehicle is in the rear seat.

Older children should be tightly secured with a safety belt, after they have outgrown a booster seat that is appropriate for their age, height and weight.

### Child-restraint system in the rear

**⚠** Children under 13 years of age and children less than 5 ft/150 cm tall should always ride in the rear and the restraint systems should be secured with the vehicle's safety belts. ◀

Younger children should be secured in an appropriate forward-facing child-restraint system that has first been properly secured. We strongly urge you to carefully read and comply with the instructions for installation and use provided by the child-restraint's manufacturer whenever you use such a device.

All rear sitting positions in your vehicle meet the recommendations of SAE J1819, an industry-recommended practice for securing child-restraint systems in motor vehicles.

### Exception for front passenger seat

**⚠** Should it become necessary to use a child-restraint system on the front passenger seat, the airbags on the passenger's side must be deactivated. Deactivating the front passenger airbag is only possible on the Coupe. Your BMW center will be glad to advise you. ◀

**⚠** Never install a rearward-facing child-restraint system in the front passenger seat of this vehicle if the passenger airbag is not deactivated. If you do so, the child could be severely injured when the airbag is triggered. Your vehicle is equipped with an airbag supplemental restraint system for the front passenger. Because the backrest on any rearward-facing

child-restraint system – of the kind designed for infants under 1 year and 20 lbs./9 kg – would be within the airbag's deployment range, you should never mount such a system in the front passenger seat, since the impact of the airbag against the child restraint's backrest could lead to serious or fatal injuries. ◀

## Installing child-restraint systems

Before installing any child-restraint system or child seat, read the following:

**⚠** Observe the child-restraint system manufacturer's instructions for installation and use. Otherwise the degree of protection can be reduced.

After an accident, have all parts of the child-restraint system and of the relevant vehicle safety belt system checked by a BMW center and replaced if necessary. ◀

Commercially-available child-restraint systems are designed to be secured with a lap belt or with the lap belt portion of a combination lap/shoulder belt. Improperly or inadequately installed restraint systems can increase the risk of injury to children. Always read and follow the instructions that come with the system.

## Child seat security



All of the rear belt retractors and the front passenger's safety belt can be locked for mounting and securing child-restraint systems.

Information regarding this is located near the buckle latch of each safety belt.

### To lock safety belt

Pull the entire length of the belt from the belt retractor. Allow the reel to retract the belt somewhat and engage the buckle, then tighten the belt against the child-restraint system. The retraction mechanism is now locked.

### To unlock safety belt

Release the buckle, remove the child-restraint system and allow the belt retractor to reel the belt completely in.

### Coupe: child-restraint system with tether strap

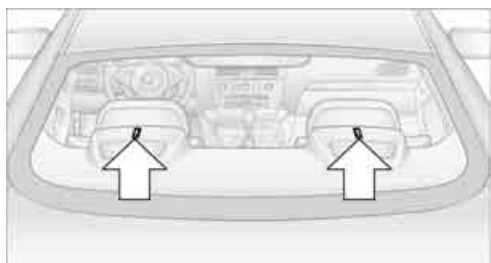

If you use a child-restraint system with a tether strap, two additional tether anchorage points have been provided – refer to the arrows in the illustration. Depending on the location selected for sitting in the rear passenger area, attach the tether strap to the corresponding anchorage point to secure the child-restraint system, as shown in the illustration below.

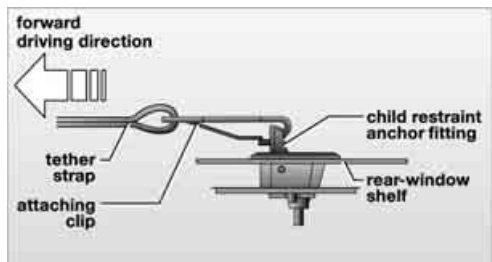

Each sitting position is fitted with a head restraint. The head restraint must be adjusted into the

lowest possible position. Pass the tether strap over the head restraint.



Adjust the tether strap according to the child-restraint manufacturer's instructions. ◀

### LATCH child-restraint fixing system

LATCH: Lower Anchor and Tethers for Children.

The rear outer sitting positions are provided with anchors for a LATCH child-restraint fixing system.



To fit the LATCH child-restraint fixing system, follow the operating and safety instructions of the system manufacturer. ◀

### Access to anchorage points



The illustrations show the right rear seat as an example. The outer anchorage points for the LATCH child-restraint fixing system are identified by flags\*.



The anchorage points for the LATCH child-restraint fixing system are identified by buttons\*.

# Driving

## Ignition lock

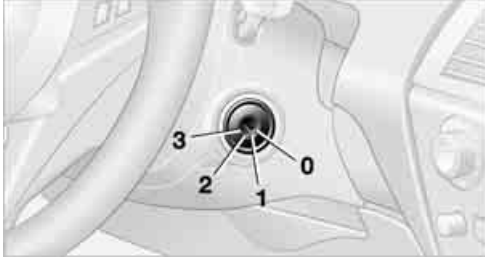

### 0 Steering locked

The key can only be inserted or removed in this position.

After removing the key, turn the steering wheel slightly until it locks.

### Interlock on automatic transmission\*

- ▷ Only move the selector lever from position P with the engine running.
- ▷ To turn the key back to position 0 or to remove it, first select the selector lever position P.

### 1 Steering unlocked

A slight steering wheel movement often makes it easier to turn the key from 0 to 1.

Some vehicle systems are ready for operation.

### 2 Ignition switched on

All vehicle systems are ready for operation.

### 3 Start engine

## Starting engine

 Do not run the engine in closed rooms, as otherwise the inhaling of toxic exhaust gases can cause unconsciousness and death. The exhaust gases contain carbon monoxide, an odorless and colorless, but highly toxic gas. Never leave an unattended vehicle with the

engine running, as such a vehicle represents a potential safety hazard.

To prevent the vehicle from rolling, always select neutral position or position N and apply the handbrake before leaving the vehicle with the engine running. ◀

When starting the engine, do not press the accelerator pedal.

Do not allow the engine to warm up by leaving it running while the vehicle remains stationary. Instead, begin to drive immediately at a moderate engine speed.

## Special starting conditions

Press the accelerator pedal halfway down when starting if

- ▷ the engine fails to start on the first attempt, for instance, if it is very hot or cold
- ▷ the engine is started at very low temperatures, below approx. +5 °F / -15 °C, at high altitudes, above 3,300 ft / 1,000 m

 Avoid frequent starting in quick succession or repeated start attempts in which the engine does not start. Otherwise, the fuel is not burned or inadequately burned and there is a danger of overheating and damaging the catalytic converter. ◀

## Manual transmission

1. Apply the handbrake.
2. Gearshift lever in neutral position.
3. Press the clutch pedal.

 If the clutch pedal is not depressed, the engine will not start. ◀

4. Start the engine.  
Do not terminate the starting operation too early, but after approx. 20 seconds at the latest. When the engine starts, release the ignition key immediately.



## SMG Sequential manual transmission\* and automatic transmission\*

Your BMW is equipped with the convenience starting feature. It is sufficient to turn the ignition key only briefly to position 3 and then release it right away. The system responds by automatically engaging the starter for a certain period and allowing it to run until the engine starts, after which it then disengages automatically.

### SMG Sequential manual transmission\*

1. Press the brake pedal.
2. Engage selector-lever position N.
3. Start the engine.

 If the engine does not start, engage the last gear selected again, refer to instrument cluster display, and then shift into position N. ◀

### Automatic transmission with Steptronic\*

1. Press the brake pedal.
2. Engage selector-lever position P or N.
3. Start the engine.

## Switching off engine

 Do not remove the ignition key while the vehicle is rolling, as otherwise the steering wheel lock will immobilize the steering. When leaving the vehicle, remove the ignition key and lock the steering. When parking on a downhill incline, apply the handbrake, as otherwise the vehicle could roll away. ◀

### Manual transmission

1. Turn the ignition key to position 1 or 0.
2. Shift into first gear or reverse.

### SMG Sequential manual transmission\*

1. Engage a drive position.
2. Turn the ignition key to position 1 or 0.  
A signal sounds on stopping the engine.

## Automatic transmission with Steptronic\*

1. Engage selector-lever position P.
2. Turn the ignition key to position 1 or 0.

## Handbrake

The handbrake is primarily intended to prevent the vehicle from rolling while parked; it brakes the rear wheels.

### Indicator lamp



The indicator lamp lights up, and an acoustic signal also sounds when starting off. The handbrake is engaged.



Indicator lamp for Canadian models.

### Engaging

The lever engages automatically.

### Releasing



Pull slightly upward, press the button and lower the lever.



If exceptional circumstances should make it necessary to engage the handbrake while the vehicle is in motion, do not pull it too strongly. In doing so, continuously press the button of the handbrake lever. Strong application of the handbrake can lead to overbraking of the rear axle and associated 'fishtailing' of the vehicle rear end. The brake lamps do not light up when the handbrake is engaged.



Vehicles with manual or SMG transmission:  
When parking on inclines, engage the hand-brake, as even engaging the first or reverse gear might not under certain circumstances secure the vehicle against moving.

Vehicles with automatic transmission\*:  
Engage selector-lever position P. ◀

 To prevent corrosion and one-sided braking action, occasionally engage the hand-brake lightly when the vehicle is slowly coming to a stop if the traffic conditions are suitable. ◀

## Manual transmission



 When shifting into 5th/6th gear, press the selector lever toward the right, otherwise an inadvertent shift into 3rd or 4th gear could damage the engine. ◀

### Reverse gear

Select only when the vehicle is stationary.  
When pressing the gearshift lever to the left, overcome some resistance.

The backup lamps automatically switch on in ignition key position 2.

## SMG Sequential manual transmission\*

### The concept

The SMG Sequential manual transmission is an automated manual transmission in which an electrohydraulic system handles the clutching and gear changes.

You operate the SMG using the selector lever in the center console and two shift paddles on the steering wheel.

It offers the following functions:

- ▷ Choice of manual or automatic mode: Sequential mode or Drive mode
- ▷ Options of two drive programs: Normal or Sport, refer to Dynamic Driving Control page 59
- ▷ Automatic downshifting and protection against incorrect shifting even in sequential operation
- ▷ Kick-down function in the Drive mode
- ▷ Acceleration assistant, refer to page 59.

The SMG is operational in ignition key position 2.

### Selector-lever positions



The current selector-lever position is displayed on the center console.

- ▷ R: Reverse gear
- ▷ N: Neutral, idle
- ▷ One-touch functions for Sequential mode:  
+ : manual upshifting  
- : manual downshifting
- ▷ D: Drive mode

 The transmission automatically shifts into N if the driver's door is opened with the engine running and neither the pedals, the shift paddles nor the selector lever are operated. This is indicated by an acoustic signal and the flashing display N in the instrument cluster. ◀

## Gear display



### R N 1 to 6

The currently engaged gear is displayed preceded by a D in Drive mode.

### Shiftlock

Press the brake pedal before shifting out of N; the shift command will not be executed unless the brake is applied.

### R Reverse

Select only when the vehicle is stationary.

### Sequential mode

After every engine start, as soon as the selector lever is pushed to the right and the brake pedal is pressed, the Sequential mode is activated.

You can shift up and down using the shifting paddles or the selector lever. You do not need to remove your foot from the accelerator to do so.

It is also possible to start off in second gear, e.g. in slippery conditions.

### D Drive mode

In the Drive mode, all forward gears are shifted automatically.

To switch from Sequential to Drive mode: Briefly press the selector lever to the right toward D.

#### Kick-down:

For rapid acceleration, e.g. passing, press the accelerator pedal as far down as it will go: you achieve maximum acceleration.

To switch back to the Sequential mode: press selector lever to the right again toward D or shift using the shifting paddles or the selector lever.

**!** Start off quickly on slopes. Do not hold the vehicle on a hill by applying the throttle, but engage the handbrake instead. Otherwise overheating can occur in the transmission region. ◀

## Gear changes

### Using selector lever

- ▶ To upshift, pull the selector lever back.
- ▶ To downshift, push the selector lever forward.

### Using shift paddles on steering wheel

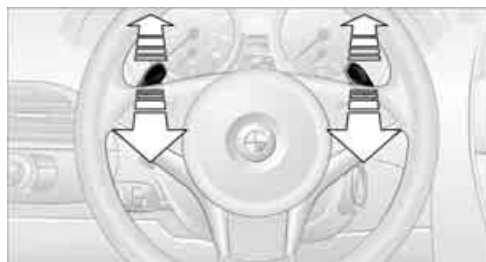

- ▶ To shift up, pull one of the shift paddles.
- ▶ To shift down, press.

In the following situations, the SMG in the Sequential mode assists you:

- ▶ Upshifts and downshifts are executed only when they will result in a plausible combination of engine and vehicle speed; thus, for example, a downshift that would cause the engine to overrev will not be executed by the system.
- ▶ When the vehicle is stationary, the transmission automatically downshifts into first gear.
- ▶ Shortly before dropping below a gear-dependent minimum speed, the transmission downshifts automatically even without your intervention.

## Automatic transmission with Steptronic\*

In addition to the fully automatic mode, you can also shift manually with Steptronic, refer to page 58.

### Selector-lever positions

P R N D M/S + -

### Displays in instrument cluster



P R N D DS M1 to M6

The selector lever position is indicated, and in the manual mode, the gear currently engaged.

### Changing the selector-lever positions



An interlock prevents inadvertent gearshifts into selector-lever positions R and P. To cancel the interlock, press the button on the front of the selector lever knob, refer to arrow.

### Shiftlock

Press the brake pedal before shifting out of P or N; the shift command will not be executed unless the brake is applied.

To prevent the vehicle from creeping after you select a driving position, maintain pressure on the brake pedal until you are ready to start.



To prevent the vehicle from rolling, always select selector-lever position P and engage the handbrake before leaving the vehicle with the engine running. Never leave an unattended vehicle with the engine running, as such a vehicle represents a potential safety hazard. ◀

### P Park

Select only when the vehicle is stationary. The rear wheels are locked.

### R Reverse

Select only when the vehicle is stationary.

### N Neutral

Engage in car washes, for example. The vehicle can roll.

### D Drive, automatic position

Position for normal vehicle operation.

All forward gears are available.

Under normal operating conditions, fuel consumption is lowest when driving in position D.

### Kick-down

The kick-down mode provides maximum acceleration:

Press the accelerator pedal beyond the full-throttle resistance point.

### M/S manual operation and Sport program



Move the selector lever from position D to the left into shifting slot M/S:

The sport program is activated and DS appears in the instrument cluster. This position is

recommended for a performance-oriented driving style. It is engaged automatically when the Dynamic Driving Control is activated, see below.

When the selector lever is briefly moved forward or back, the manual mode is activated and the Steptronic shifts gear. The instrument cluster shows M1 through M6.

Upshifts and downshifts are executed only when they will result in a plausible combination of engine and vehicle speed; thus, for example, a downshift that would cause the engine to overrev will not be executed by the system. The selected gear appears briefly in the instrument cluster, followed by the current gear.

To use the automatic function again, move the selector lever to the right into position D.

## Dynamic Driving Control

The Dynamic Driving Control makes it possible for your BMW to react in an even more performance-oriented manner at the push of a button:

- ▶ The engine responds more spontaneously to accelerator pedal movements.
- ▶ Cruise control:  
The stored speed is reached more quickly when it is requested.

Additionally with SMG:

- ▶ Gearshifts are faster.
- ▶ The engine speed range is used optimally in the Drive mode.

With automatic transmission:

- ▶ The Sport program is activated.

## Activating system



In ignition key position 2, press the SPORT button.

The LED in the button lights up and SPORT is displayed in the instrument cluster.

## Deactivating system

- ▶ Press the SPORT button again or
- ▶ engage reverse gear or
- ▶ switch off the engine.

The LED in the button and SPORT in the instrument cluster go out.

## Acceleration assistant with SMG

The acceleration assistant enables optimized vehicle acceleration at racing car level on road surfaces with good adhesion when starting off.



Do not use the acceleration assistant too often, as otherwise components will wear prematurely. ◀

1. Activate the Dynamic Driving Control.
2. Press the DTC button, refer to page 82, for longer than three seconds.
3. Press the accelerator pedal down fully: Kick-down. The ideal starting-off engine speed is set.



To maintain driving stability, do not deactivate DSC if at all possible. ◀

## Turn signals/ headlamp flasher

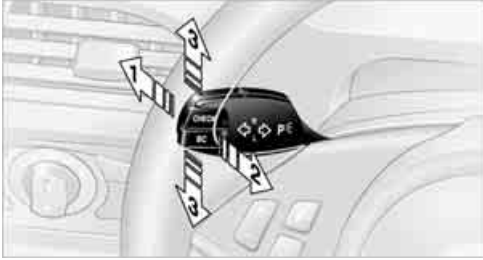

- 1 High beams
- 2 Headlamp flasher
- 3 Turn signals

### Using turn signals

Move the lever beyond the resistance point.

To switch off manually, press the lever to the resistance point.

 Atypically rapid flashing of the indicator lamp indicates the failure of a turn signal lamp. ◀

### Brief signaling

Press the lever to the resistance point and hold it there as long as you wish to signal.

### Triple turn signal activation

Press the lever to the resistance point; the turn signals flash three times.

You can activate or deactivate this function.

Control Center, for principle details, refer to page 16.

1. Open the  menu.
2. Select "Vehicle settings" and press the controller.

3. Select "Light" and press the controller.



4. Select "Triple turn signal activation" and press the controller.

Triple turn signal is activated.

## Wiper system



- 1 Switching on wipers
- 2 Switching off wipers or brief wipe
- 3 Activating/deactivating rain sensor
- 4 Cleaning windshield and headlamps
- 5 Adjusting rain sensor sensitivity level

### Switching on wipers

The lever automatically returns to its initial position when released.

### Standard wiper speed

Press once.

The system reverts to operation in the intermittent mode whenever the vehicle is stationary.

### Fast wipe

Briefly press twice or press beyond the resistance point.

The system reverts to operation at normal speed whenever the vehicle is stationary.

## Rain sensor

Wiper operation is controlled automatically as a function of the rain intensity. The rain sensor is located on the windshield, directly in front of the interior rearview mirror.

## Activating rain sensor

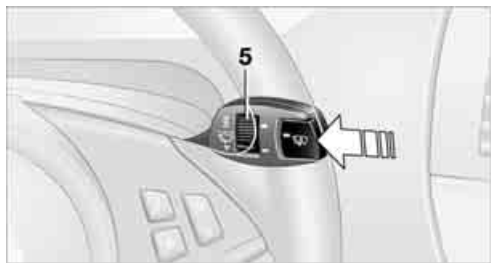

Press button. The LED in the button lights up.

## Adjusting rain sensor sensitivity level

Turn the serrated dial 5.

## Deactivating rain sensor

Press the button again. The LED goes out.

**!** Deactivate the rain sensor when passing through an automatic car wash. Failure to do so could result in damage caused by undesired wiper activation. ◀

## Cleaning windshield and headlamps

The system sprays washer fluid against the windshield and activates the wipers for a brief period.

When the vehicle lighting system is switched on, the headlamps are also cleaned at regular and appropriate intervals.

**!** Do not use the washers if there is any danger that the fluid will freeze on the windshield. If you do so, your vision could be obscured. To avoid freezing, use a washer fluid antifreeze, refer to Washer fluid.

Do not use washers when the washer fluid reservoir is empty, as otherwise the washer pump will be damaged. ◀

## Windshield washer nozzles

The windshield washer nozzles are automatically heated in ignition key position 2.

## Washer fluid

**!** Washer fluid antifreeze is flammable. Always keep it well away from sparks and open flames, and store it in tightly closed containers well out of the reach of children. Always observe the instructions for use provided on the containers. ◀

## Washer fluid reservoir



Capacity approx. 5.3 US quarts/5 liters

Fill with water and – if required – with a washer antifreeze, according to manufacturer's recommendations.

**▶** In order maintain the mixture ratio, mix the washer fluid before filling. ◀

## Cruise control

### The concept

The cruise control is available for use at speeds of approx. 20 mph/30 km/h and higher. The vehicle maintains and stores the speed that you set using the lever mounted on the steering column.

**!** Do not use the cruise control under driving conditions that do not permit a constant speed, e.g. when driving on winding roads, in heavy traffic or in poor road conditions such as snow, rain, ice, and loose road surface. ◀

## One lever for all functions



- 1 Maintaining speed, storing speed, and accelerating
- 2 Maintaining speed, storing speed, and decelerating
- 3 Interrupting cruise control
- 4 Recalling stored speed

### Maintaining speed, storing speed, and accelerating

Press the lever up to the resistance point **1**: The system maintains and stores the current vehicle speed. The display **1** in the speedometer indicates this regulated speed, refer to the section below. Every time you briefly press the lever, the vehicle speed increases by roughly 1 mph/1 km/h.

Press the lever up to the resistance point and hold it:

The vehicle accelerates without pressure on the accelerator pedal. The system maintains and stores your current speed as soon as you release the lever.

Press the lever beyond the resistance point: The speed increases by 5 mph/10 km/h.

The vehicle may accelerate beyond the regulated speed on steep downhill stretches where the engine's braking effect alone may not be sufficient to slow the vehicle. Speed can drop on uphill grades if the engine output is insufficient.

### Maintaining speed, storing speed, and decelerating

Pull the lever **2**:

Functions are the same as **1**, only the vehicle speed is reduced.

## Interrupting cruise control

With the cruise control active, briefly press the lever up or down **3**.

Cruise control is also interrupted automatically

- ▷ when you apply pressure to the brake pedal
- ▷ when you press down the clutch pedal or engage position N of the automatic transmission/SMG
- ▷ when DSC comes on

## Recalling stored speed

Briefly press button **4**: the vehicle accelerates to and maintains the stored speed.

## Deactivating system

When the ignition is switched off, the system is deactivated and the stored speed is deleted.

## Displays in instrument cluster



- 1 Display for stored speed
- 2 Brief display of selected speed

## Active cruise control\*

### The concept

With active cruise control, you can select a desired speed which is not only automatically maintained when driving on open roadways, but also varied to maintain a selected distance setting as slower traffic is encountered.

Active cruise control is a technological advance over the familiar cruise control and is a welcome relief from the constant adjustment of speed that can accompany driving in traffic on freeways or other high-speed thoroughfares. Espe-



cially on longer trips, the system can reduce fatigue and tension, while increasing your enjoyment of driving. Please use it safely and responsibly.

In addition to holding a steady cruising speed, if you encounter slower vehicles ahead, active cruise control will, within the scope of given possibilities, adjust your vehicle's speed automatically so that one can flow with the traffic without having to make constant adjustments. If, for example, while cruising at the selected speed, you begin to approach a slower vehicle ahead of you in the same lane, the system will reduce your vehicle's speed to the same as that of the vehicle ahead to maintain your selected distance setting between your vehicle and the vehicle ahead. There are four settings for distance, which are additionally speed-dependent. Based on your selected distance setting, the system automatically decreases the throttle setting and lightly applies the brakes if necessary. The vehicle brake lamps will automatically illuminate to signal a following driver to take action. In addition, it may be necessary for the vehicle or the driver to downshift, depending on the kind of transmission your vehicle is equipped with, to maintain the distance setting selected. If the vehicle ahead speeds up or when the lane ahead becomes clear, your vehicle will accelerate to the speed you have selected by increasing the throttle setting and shifting gears automatically or by the driver as needed.

 Active cruise control is not and must not be used as a collision avoidance/warning system. ◀

 Since this active cruise control system is a new technology and operates differently from conventional cruise control systems which you may be accustomed to, you are strongly urged to read all of the pages relating to this system before use. Pay special attention to the information contained in the Things to know about active cruise control section in this manual beginning on page 66. ◀

## Vehicles with manual transmission

You can use the system in the 2nd to 6th gear within a normal engine speed range and also change gears. Continuous operation at very high or very low engine speeds is not possible. In this case the driver is asked to shift or the system deactivates itself.

## Vehicles with SMG

Continuous operation at very high engine speeds is not possible in the Sequential mode. In this case the driver is asked to shift or the system deactivates itself. In the Drive mode the SMG acts similarly to the automatic transmission in the D position.

## Operating active cruise control



- 1 Activate system, store and increase desired speed
- 2 Activate system, store and decrease desired speed
- 3 Deactivate system
- 4 Recall the stored speed and distance or increase desired speed by 1 mph/1 km/h with each press of the button
- 5 Select distance to vehicle driving ahead. You can choose from four available distance settings. You will find more detailed information on page 65.

 Adjust your desired speed to the traffic conditions and remain ready to brake at all times. Great differences in speed to the vehicles driving ahead, e.g. when quickly approaching a truck or when another vehicle swerves into your lane, cannot be compensated for by the system. ◀



## Displays in instrument cluster



- 1 Stored desired speed display
- 2 Detected vehicle display.  
Lights up when vehicle driving ahead is detected
- 3 Selected distance to vehicle driving ahead
- 4 Digital speed display.  
Appears briefly when you select your desired speed



The system is activated.  
The display **3** appears as soon as you activate the system and no vehicle is detected driving ahead.



Vehicle detected.  
The display **2** lights up yellow when a vehicle is detected driving ahead.



The system requests that you intervene by braking or with an evasive maneuver.

The display **2** flashes red and a signal sounds. The active cruise control cannot automatically restore the distance to the vehicle driving ahead. You will find more detailed information on page [67](#).



Automatic intervention by ABS or DSC, or you actuate the parking brake while driving.

The display **2** flashes yellow. The active cruise control now only intervenes by braking.

## Desired speed store and increase



Press the lever forward **1** at a driving speed of more than approx. 20 mph/30 km/h:  
The system adopts and stores your current speed as a desired speed. This speed is indicated on the speedometer and displayed briefly in the instrument cluster.

Subsequently pressing forward increases the desired speed to the next multiple of 5 mph/10 km/h.

Each time the lever is pressed forward again, the desired speed is increased by another 5 mph/10 km/h until a maximum of 110 mph/180 km/h is reached. The speed then displayed is stored and achieved, provided that the road is clear.



If the display ACC --- mph/km/h briefly appears in the instrument cluster, it might be that conditions necessary for operation are not currently being met.

To call up Check Control messages, refer to page [71](#).

## Desired speed store and decrease

Pull back the lever **2**:

The current driving speed is rounded off to the next multiple of 5 mph/10 km/h, displayed and stored.

Each time the lever is pulled back again, the desired speed is decreased by another 5 mph/10 km/h until the minimum speed of 20 mph/30 km/h is reached. The speed then displayed is stored and achieved, provided that the road is clear.

## Deactivate system

Press the lever up or down while the system is active **3**. The displays in the instrument cluster disappear. You can use the system again as required.

In addition, the system is deactivated automatically:

- ▷ When you apply pressure to the brake pedal
- ▷ When you select the automatic transmission's/SMG neutral position N
- ▷ When the manual transmission is in neutral
- ▷ When you deactivate the DSC Dynamic Stability Control
- ▷ When you actuate the parking brake during driving
- ▷ When the system reduces the speed to below 20 mph/30 km/h due to a traffic situation

 The system deactivates automatically when the speed is set to below 20 mph/30 km/h. An acoustic signal sounds and a message appears on the Control Display. The active intervention of the driver is required. ◀

When you switch off the ignition, the stored desired speed is deleted.

## Resume to stored desired speed and distance setting

Press button **4** when the system is deactivated. The displays appear in the instrument cluster. The system is reactivated and uses the last stored desired speed and distance setting.

## Fine adjustment of desired speed

In the activated state, the desired speed increases by 1 mph/1 km/h each time button **4** is pressed briefly.

## Select distance

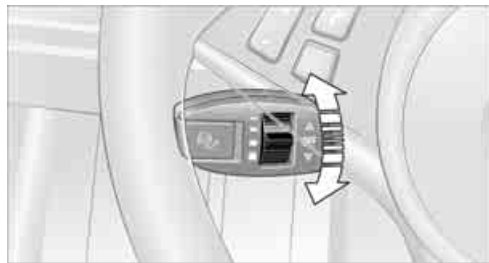

You can choose from four distance steps.

- ▷ Rotary switch downward: Increase distance.
- ▷ Rotary switch upward: Decrease distance.

The selected distance is displayed in the instrument cluster.



Distance 1



Distance 2



Distance 3

This distance is always set when the system is used for the first time after starting the engine.



Distance 4

 Use good judgment to select the appropriate following distance given road conditions, traffic, applicable laws and driving recommendations for safe following distance. ◀

## Things to know about active cruise control

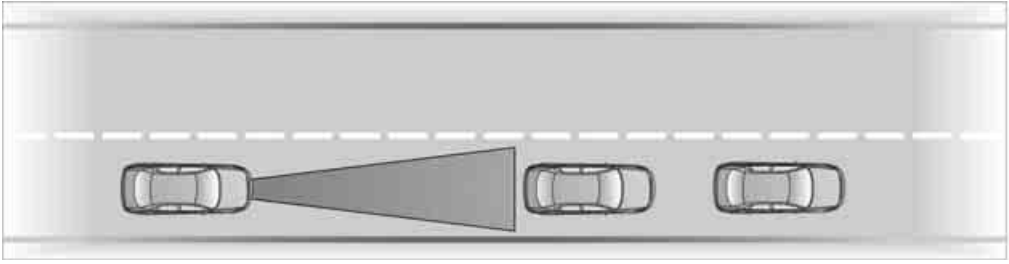
WVZ2881039A

**⚠** As with conventional cruise control systems, active cruise control in no way diminishes or substitutes for the driver's own personal responsibility, alertness and awareness in adjusting speed, braking or otherwise controlling the vehicle. The driver should decide when to use the system on the basis of road, traffic, visibility, and weather conditions. Active cruise control is intended for use on highway-type roadways where traffic is moving relatively smoothly. Do not use this system in city driving; heavy traffic such as during rush hour; on curvy, winding roads, slippery roads or roads with sharp curves such as highway off-ramps; during inclement weather such as snow, strong rain or fog; or when entering interchanges, service/parking areas or toll booths. It is also important to regulate your vehicle's speed and distance setting within applicable legal limits. Always be ready to take action or apply the brakes if necessary, especially when the system is actively following a vehicle in front of you. ◀

**⚠** Always remember that the range and ability of the system does have physical limitations. It will not apply the brakes or decelerate your vehicle when there is a slow-moving vehicle, stopped vehicle or stationary object ahead of you, as for example, at a traffic light or when approaching a parked vehicle. Also, the system does not react to oncoming traffic, pedestrians or other types of potential traffic such as a rider on horseback. It is also possible that the system may not detect smaller moving objects such as motorcycles or bicycles. Be especially alert when encountering any of these situations as the system will neither automatically brake, nor provide a warning to you. Also, be aware that

every decrease in the distance setting allows your vehicle to come closer to a vehicle in front of you and requires a heightened amount of alertness. ◀

If your vehicle is actively following a vehicle in front of you and the vehicle ahead speeds up or the lane ahead becomes clear, then your vehicle will accelerate to the speed you have selected. Be aware that changing to a clear, unobstructed lane will also result in your vehicle accelerating.

**⚠** Be certain to deactivate the system when you pull into an exit lane for a highway off-ramp. ◀

Also, vehicles traveling in a staggered manner on a highway may cause a delay in the system's reaction to a vehicle in front of you or may cause the system to react to a vehicle actually in the lane next to you. Always be ready to take action or apply the brakes if necessary.

Active cruise control can only decelerate the vehicle to approx. 20 mph/30 km/h. If the system reduces vehicle speed below 20 mph/30 km/h or if DSC/ABS is engaged while driving, the system will automatically deactivate.

**⚠** Remember, the system cannot stop your vehicle. In addition, the system is deactivated whenever the driver applies the vehicle brakes, shifts the transmission to neutral/N, or deactivates DSC. After any deactivation, the system will no longer automatically activate the vehicle brakes, which means the driver must intervene and resume manual braking. You should then reactivate the system only when you are fully aware of the prior speed and distance settings. ◀

Active cruise control may brake when you reduce the stored desired speed; however, the driver must constantly monitor traffic and intervene if necessary.

When you switch off the engine or ignition, active cruise control is fully switched off, too, and any settings you have selected are canceled.

## Behavior in curves

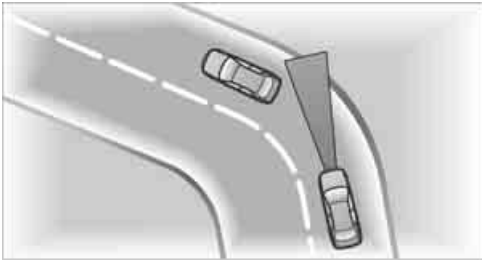



Because of the limited range of the system, it is possible that in curves or on the peaks and valleys of hilly roads, a vehicle ahead may be recognized late, or not at all. Therefore, it is up to the driver to select a speed that is prudent in view of the curves and terrain of the roadway.



In approaching a curve, it is possible that active cruise control would react briefly to a vehicle in the adjacent lane. In addition, the system can sense if your vehicle is in a curve and may not accelerate. If your vehicle decelerates in either case, you can choose to overcome the deceleration by briefly pressing the accelerator pedal.

## Driver interventions

 Anytime the driver presses down on the accelerator pedal, any automatic braking action by the system is interrupted until the pedal is fully released. After doing this, release the accelerator and the system again controls your cruising speed and distance setting. While driving with activated system, resting your foot on the accelerator pedal will cause the system not to brake even if necessary. Be certain that floor mats or other objects on the vehicle floor do not interfere with movement of the accelerator pedal. ◀

 While active cruise control is capable of braking your vehicle automatically when you approach a slower vehicle ahead, it is important to be aware that the ability of the system to apply the brakes is also limited, if you are driving down a steep grade or when you reduce your desired speed sharply. The system cannot stop your vehicle. It uses only a portion of braking system capacity and does not utilize the full capacity of the vehicle braking system. Therefore, the system cannot decrease your speed for large differences in speed between your vehicle and the vehicle ahead. Examples: during emergency braking, when you approach a vehicle traveling at a much lower speed than your own speed such as when approaching a toll booth or when a much slower vehicle cuts in front of you at close range. ◀



Whenever active cruise control recognizes a situation that requires driver braking because the system capacity has been reached or has been exceeded, the system alerts the driver by flashing this symbol in the instrument cluster and sounding a signal.

## Swerving vehicles

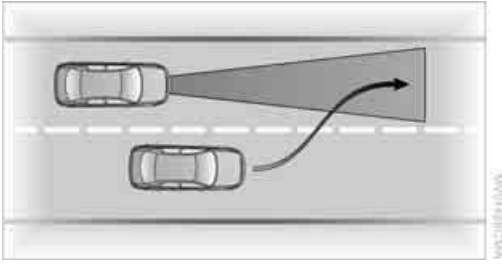

When a vehicle moves from an adjacent lane into your lane, active cruise control will not recognize this vehicle until it is fully in your lane ahead of your vehicle.

### Malfunction



The indicator lamp lights up and a message appears on the Control Display.

The build-up of foreign matter, e.g., snow, ice, dirt, road debris, etc., can lead to reduced detection performance of active cruise control. You should check the sensor under the front bumper and clean it as necessary prior to driving your vehicle. If the sensor becomes covered by foreign matter or has a malfunction, it is possible that the sensor will no longer be able to detect vehicles in front of you. After the system recognizes that the sensor is no longer functional, a message is displayed on the Control Display and an acoustic signal is emitted.

When the system does not detect any objects, e.g. on seldom used roads without a shoulder or guard rails, the system may temporarily deactivate itself.

# Everything under control

## Odometer, outside temperature display, clock



When the ignition is off you can briefly activate the time, outside temperature and odometer displays by pressing the knob **3** at the lower left of the instrument cluster.

### 1 Outside temperature display, clock, date

The outside temperature and the time are displayed from ignition key position 1 onwards.

To call up the date:

Press the CHECK button on the turn signal lever, refer to page 74.

Setting time and date, refer to page 78.

You can set the measurement unit °F or °C on the Control Display, refer to Measurement units on page 77.

### Ice warning

A signal sounds when the outside temperature falls to roughly +37.5 °F / +3 °C; this is accompanied by a message.



Please bear in mind that the ice warning does nothing to alter the fact that black ice may be present on roads at temperatures higher than +37.5 °F / +3 °C, e.g. on bridges and shaded roads. ◀

### 2 Odometer and trip odometer

To reset the trip odometer to zero:

Press button **3** in the instrument cluster.

## Tachometer



The white-striped advance warning field, arrow **1**, changes depending on the engine temperature. The segments disappear in sequence as the engine warms to its normal operating temperature.

Avoid allowing the engine speed to rise as far as the advance warning field whenever possible.

Engine speeds in the red warning field, arrow **2**, must absolutely be avoided.

In this range, the fuel supply is interrupted to protect the engine.

## Engine oil thermometer



The engine oil temperature is between approx. 160 °F / 70 °C and approx. 340 °F / 170 °C during normal operation.

If the engine oil temperature is too high, a message appears on the Control Display.

## Fuel gage



Fuel tank capacity: approx. 18.5 US gallons / 70 liters, including the reserve capacity of approx. 2.1 gallons / 8 liters. You can find information on refueling on page 166.

If the tilt of the vehicle varies for a longer period, when you are driving in mountainous areas, for example, the indicator may fluctuate slightly.

After the reserve quantity has been reached, a message appears for a short time on the Control Display; the remaining range is shown in the computer. Below a range of approx. 30 miles / 50 km, the message remains on the Control Display.

 Refuel as soon as possible once your cruising range falls below 30 miles / 50 km, as otherwise engine functions are not ensured and damage can occur. ◀

## Service requirements



The remaining distance to be driven and the date for the next maintenance are briefly indicated with the ignition key in position 2.

 Your BMW Service Advisor will determine your vehicle's current service requirements by reading out the data stored in the master key. ◀

### Additional information

You can view additional information on service and maintenance procedures on the Control Display.

Control Center, for principle details, refer to page 16.

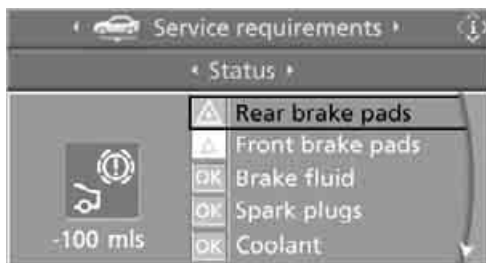

1. Open the  menu.
2. Select "Service" and press the controller.
3. Select "Service requirements" and press the controller.
4. Select "Status" and press the controller.

The display shows a list of selected service and maintenance procedures, as well as legally mandated official inspections.







## Symbols

-  No service is currently required.
-  The deadline for service or an official inspection is approaching. Please arrange a service appointment soon.
-  The service deadline has already passed.

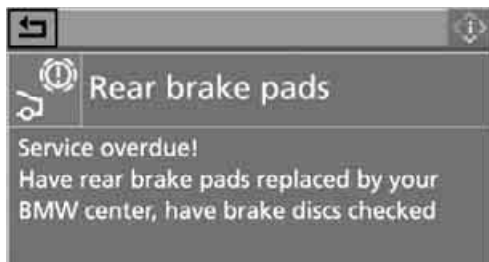
You can request more detailed information on every entry.



- Select the entry and press the controller.
- To exit from the menu:
  -  Select the arrow and press the controller.

## Entering dates for state emission and vehicle inspections

Make sure the date in the Control Center is always set correctly, refer to page 78, as otherwise the effectiveness of CBS Condition Based Service is not ensured.

Control Center, for principle details, refer to page 16.

1. Open the  menu.
2. Select "Service" and press the controller.
3. Select "Service requirements" and press the controller.
4. Select "Status" and press the controller.

5. Select "Emission inspect." or "State inspection" and press the controller.

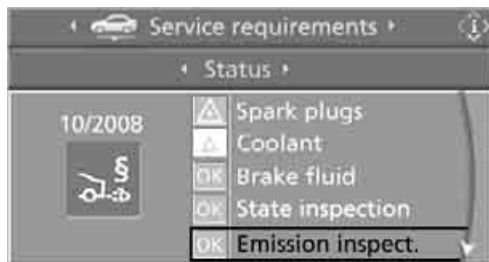

6. Select "Set service date" and press the controller. The month is highlighted.
7. Turn the controller to make the adjustment.



8. Press the controller to apply the setting. The year is highlighted.
9. Turn the controller to make the adjustment.
10. Press the controller to apply the setting. The date entry is stored.

- To exit from the menu:
  -  Select the arrow and press the controller.

## Check Control

### The concept

The Check Control monitors functions in the vehicle and issues a message if there is a malfunction in the monitored systems.

Supplementary messages on the Control Display are intended to assist you in assessing the severity of malfunctions; they provide you with the information you need to decide on the best way to respond.



An example of a message is given below:

### In instrument cluster



▲ This symbol means that a Check Control message has been generated. The symbol continues to be displayed after the message has been hidden automatically after a short time, but is still stored.

### On Control Display



An acoustic signal sounds at the same time.

### Supplementary instructions

An example:

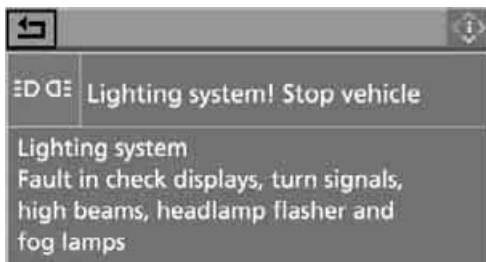

Exit the additional information:

← Select the arrow and press the controller.

### Importance of messages

Important messages are retained until the malfunctions have been rectified. They cannot be deleted. If a number of these malfunctions occur simultaneously, they are displayed in succession.

Less important messages are displayed for approx. 20 seconds, but continue to be stored.

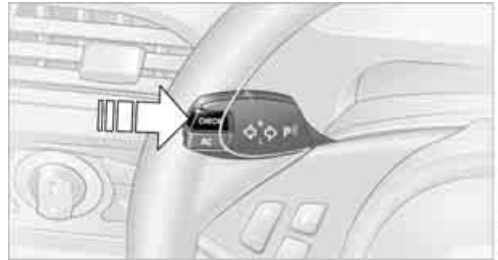

To hide these messages during the display time:

Press the CHECK button on the turn signal lever.

### Check Control symbol and message on Control Display

- OK No malfunctions detected in the monitored systems.
- ▲ Malfunctions detected in the monitored systems.
- ▲ Depending on the malfunction, additional information appears on the Control Display.

The symbols also indicate the status of the service requirement display, refer to page 71.

## Displaying stored messages

### Using CHECK button

1. Press the button longer:  
The first stored message is displayed.

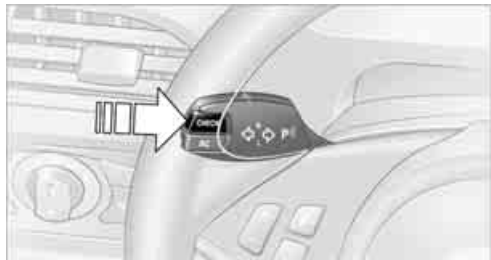

2. Press the button:  
A new message appears each time you press the button.

### Using Control Center

Control Center, for principle details, refer to page 16.

1. Press the **MENU** button.  
This opens the start menu.



2. Press the controller to open the **i** menu.
3. Select "Service" and press the controller.
4. Select "Check Control messages" and press the controller. The stored messages appear on the display.

5. Select a message and press the controller.

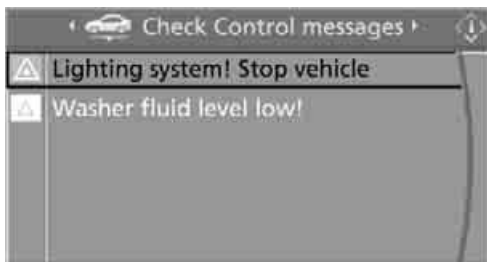

The display disappears automatically after a short time.

To exit from the menu immediately:

- ▶ Select the arrow and press the controller.

### Displays after completion of trip

Malfunction reports generated during the trip are shown consecutively when you switch off the ignition.

Before the display disappears, you can display the messages once again. Press the CHECK button for approx. 2 seconds. If several messages are present, you can press the CHECK button repeatedly.

The display:

- ▶ cancels itself automatically after a brief period
- ▶ can be canceled at any time pressing the CHECK button again for approx. 2 seconds

## Computer

### Requesting information

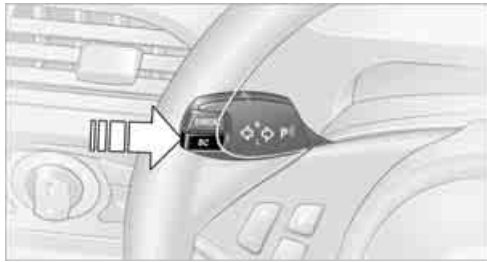

As of ignition key position 1, you can use the BC button in the turn signal lever to call up computer information in the instrument cluster.

A new function appears each time you press the BC button.

### In instrument cluster



The display sequence:

- ▷ Cruising range
- ▷ Average speed
- ▷ Average fuel consumption

### Cruising range

Displays the estimated cruising range available with the remaining fuel. It is projected by taking into account the driving style over the last 20 miles/30 km.

**⚠** Refuel as soon as possible once your cruising range falls below 30 miles/50 km, as otherwise engine functions are not ensured and damage can occur. ◀

### Average speed

Periods with the vehicle parked and the engine off are not included in the calculations of average speed.

To reset the average speed: press the BC button in the turn signal lever for approx. 2 seconds.

### Average fuel consumption

The average fuel consumption is calculated for the time during which the engine is running.

You can use the Control Display to view your fuel consumption rate over two different distances, refer to page 75.

To reset the average fuel consumption: press the BC button in the turn signal lever for approx. 2 seconds.

### On Control Display

You can also call up the computer via the Control Center, for principle details, refer to page 16.

1. Press the **MENU** button.  
This opens the start menu.



2. Move the controller to the right to open "Navigation".  
On vehicles without navigation system: Open "Car Data".
3. Select "Car Data" and press the controller.

You can now choose between:

- ▷ Computer
- ▷ Trip computer, suitable e.g. for a vacation trip

## Computer

Select "Onboard info" and press the controller.



- ▶ Estimated time of arrival at destination:
  - ▶ Entering a distance manually in the computer, see below.
  - ▶ Entering a destination in the navigation system\*, refer to page 115.
- ▶ Cruising range
- ▶ Distance to destination:
  - ▶ Entering a distance manually in the computer, see below.
  - ▶ Entering a destination in the navigation system\*, refer to page 115.
- ▶ Average speed
- ▶ Average fuel consumption

## Trip computer

Select "Trip computer" and press the controller.

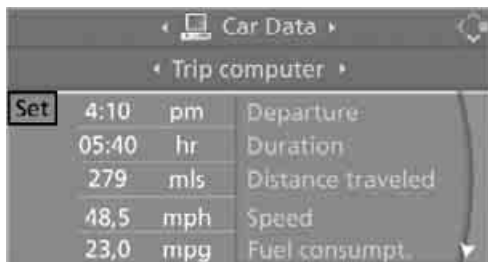

- ▶ Departure time
- ▶ Driving time
- ▶ Distance traveled
- ▶ Average speed
- ▶ Average fuel consumption

Start or stop trip computer, or reset all values:

1. Select "Set" and press the controller.
2. Select the desired menu item.
3. Press the controller.

## Entering a distance manually

Control Center, for principle details, refer to page 16.

1. Open "Navigation".  
On vehicles without navigation system:  
Open "Car Data".
2. Select "Car Data" and press the controller.
3. Select "Onboard info" and press the controller.
4. Select "Distance to dest." and press the controller.

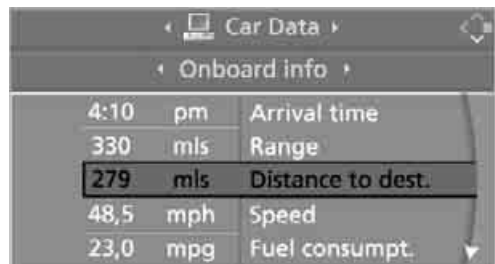

5. Turn the controller to select the distance to your destination. If necessary, hold it against a slight resistance to enter a greater difference.

6. Press the controller to apply the setting.

The distance is automatically predetermined during the destination guidance of the navigation system\*.

## Display options

You can display the computer or the trip computer in the assistance window.

Control Center, for principle details, refer to page 16.

1. Move the controller to the right to change to the assistance window and press the controller.



2. Select a menu item:
  - ▷ "Onboard info"
  - ▷ "Trip computer"
3. Press the controller.



## Speed limit

You can enter a speed and a Check Control message indicates when you have reached this speed. This enables you, for example, to receive warnings if you exceed a speed limit in an urban area.

You are only warned of reaching this speed a second time if your vehicle has fallen at least 3 mph/5 km/h below it in the meantime.

### Entering, changing

Control Center, for principle details, refer to page 16.

1. Open "Navigation".  
On vehicles without navigation system:  
Open "Car Data".
2. Select "Car Data" and press the controller.

3. Select "Limit" and press the controller.



4. Select the speed and press the controller.
5. Turn the controller to set the limit. If necessary, hold it against a slight resistance to enter a greater difference.
6. Press the controller to apply the setting.

### Applying your current speed as limit

Control Center, for principle details, refer to page 16.

1. Open "Navigation".  
On vehicles without navigation system:  
Open "Car Data".
2. Select "Car Data" and press the controller.
3. Select "Limit" and press the controller.
4. Select "Select current speed" and press the controller. The system applies your current speed as the limit.

### Activating limit

Control Center, for principle details, refer to page 16.

1. Open "Navigation".  
On vehicles without navigation system:  
Open "Car Data".
2. Select "Car Data" and press the controller.
3. Select "Limit" and press the controller.
4. Select "On" and press the controller.  
 Limit is activated.

## Stopwatch

Control Center, for principle details, refer to page 16.

1. Open "Navigation".  
On vehicles without navigation system:  
Open "Car Data".
2. Select "Car Data" and press the controller.
3. Select "Stopwatch" and press the controller.



### Starting and stopping

- ▷ Select "Start" and press the controller.  
The stopwatch starts at the displayed time.
- ▷ Select "Reset" and press the controller.  
The stopwatch is reset and it restarts if it was running beforehand.
- ▷ Select "Stop" and press the controller.  
This stops the timer.

### Taking an intermediate time reading

Select "Interim time" and press the controller. The interim time appears below the ongoing primary stopwatch count.

- ▷ All of the remaining functions remain available at all times while the stopwatch is running. The stopwatch continues operation in the background. ◀

## Settings on Control Display

### Brightness of Control Display

The brightness is automatically adapted to the ambient lighting conditions. However, you can change the base setting.

Control Center, for principle details, refer to page 16.

1. Press the **MENU** button.  
This opens the start menu.



2. Press the controller to open the **i** menu.
3. Select "Display settings" and press the controller.
4. Select "Brightness" and press the controller.
5. If necessary, move the controller to the right to select "Display Offset".
6. Turn the controller until the desired setting is selected.

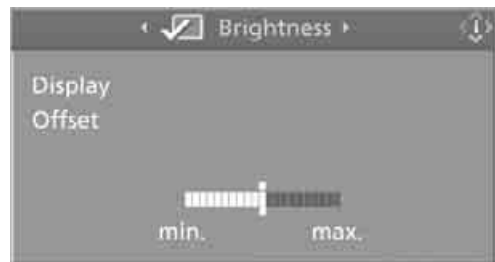

The setting is stored for the remote control currently in use.

### Measurement units

You can change the measurement units for consumption, distances, temperature and pressure.

1. Open the **i** menu.
2. Select "Display settings" and press the controller.

3. Select "Units" and press the controller.

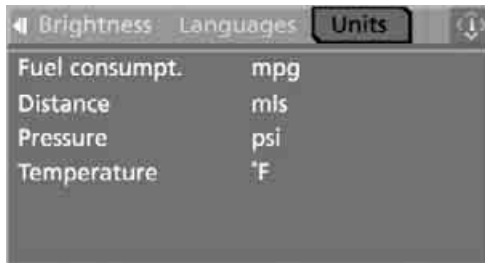

4. Select the menu item to be set.
5. Press the controller.
6. Select the desired measurement unit and press the controller.

The settings are stored for the remote control currently in use.

### Language on Control Display

Control Center, for principle details, refer to page 16.

1. Open the **i** menu.
2. Select "Display settings" and press the controller.
3. Select "Languages" and press the controller.

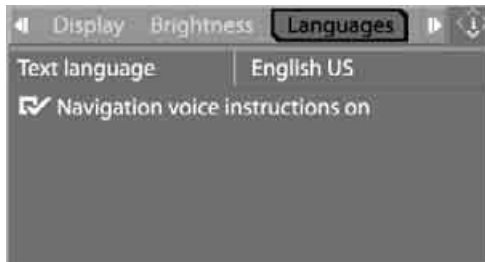

4. Select "Text language" and press the controller. You can select a different language for the text displays.
5. Select the desired language and press the controller.

The setting is stored for the remote control currently in use.

### Setting time

Control Center, for principle details, refer to page 16.

1. Open the **i** menu.
2. Select "Display settings" and press the controller.
3. Select "Time" and press the controller.

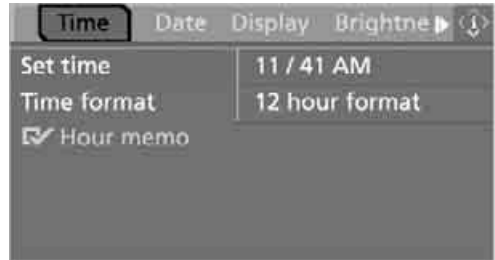

4. Select "Set time" and press the controller. The hours are selected.
5. Turn the controller to set the hours.
6. Press the controller to apply the setting. The next adjustment is highlighted.
7. Make the remaining adjustments. After the last adjustment, the time is stored.

### 12h/24h mode

1. Select "Time format" and press the controller.
2. Select the desired mode and press the controller.

The setting is stored for the remote control currently in use.

### Switching on hour signal\*

You will hear three tones just before each full hour.

Select "Hour memo" and press the controller.

The hour signal is activated.

### Setting date

Control Center, for principle details, refer to page 16.

1. Open the **i** menu.
2. Select "Display settings" and press the controller.

3. Select "Date" and press the controller.
4. Select "Set date" and press the controller.  
The first section of the date display is highlighted, in this case the month.

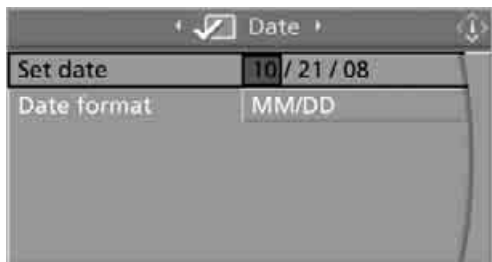

5. Turn the controller to make the adjustment.
6. Press the controller to apply the setting.  
The next adjustment is highlighted.
7. Make the remaining adjustments. After the last adjustment, the date is stored.

### Changing date format

1. Select "Date format" and press the controller.
2. Select the desired format and press the controller.

The setting is stored for the remote control currently in use.



# Technology for comfort, convenience and safety

## PDC Park Distance Control\*

### The concept

The PDC assists you when you are parking. Audible signals and an optical display\* indicate that you are approaching an object in front of or behind your vehicle. To measure the distance, there are four ultrasonic sensors in each bumper. The sensors at the front and at the two rear corners have a range of approx. 24 in/ 60 cm; the rear middle sensors have approx. 5 ft/1.50 m.

 PDC is a parking aid that can indicate objects when they are approached slowly, as is usually the case when parking. Avoid approaching an object at high speed, as otherwise the physical circumstances would mean that the system warning was too late. ◀

### Automatic mode

In ignition key position 2, the system automatically assumes operational status after approx. 1 second each time you shift into reverse or move the selector-lever to position R.

Wait this short period before driving. The system switches off when you disengage the reverse gear.

### Manual mode



Press the button; the LED lights up.

### Deactivating manual mode

Press the button again; the LED goes out.

The system is automatically deactivated once the vehicle travels approx. 165 ft/50 m or exceeds a speed of roughly 20 mph/30 km/h; the LED goes out. You can reactivate the system manually as needed.

### Signal tones

An intermittent signal indicates the distance of the vehicle from an object being approached. Thus, an object detected to the left rear of the vehicle will be indicated by a signal tone from the left rear speaker, etc. As the distance between vehicle and object decreases, the intervals between the tones become shorter. The signal tone becomes continuous once the distance to the nearest object falls to below roughly 1 ft/30 cm.

The warning signal is canceled after approx. 3 seconds if you are moving parallel to a wall.

### Malfunction

The LED in the button flashes and a message appears on the Control Display. PDC is malfunctioning. Have the system checked.

As a preventive measure, keep the sensors clean and free of ice or snow in order to ensure that they will continue to operate effectively.

### PDC with visual warning\*

You also enjoy the option of having the system show the approach to an object on the Control Display. The Control Display also indicates the presence of objects before they are close enough to trigger a signal tone.

Control Center, for principle details, refer to page 16.

1. Press **MENU** button.  
This opens the start menu.



2. Press the controller to open the **i** menu.
3. Select "Vehicle settings" and press the controller.
4. Select "PDC" and press the controller.
5. Select "Monitor display on" and press the controller.

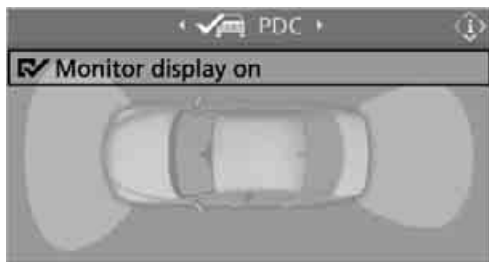

**✓** The PDC screen is activated.  
The display appears on the Control Display as soon as PDC is activated.  
The setting is stored for the remote control currently in use.

### System limits

**⚠** Even with PDC, final responsibility for estimating the distance between the vehicle and any obstructions always remains with the driver. Even when sensors are involved, there is a blind spot in which objects cannot be detected. The system is also subject to the physical limits that apply to all forms of ultrasonic measurement, such as those encountered with thin and wedge-shaped objects, etc. Low objects already displayed, e.g. a curb, can also disappear from the detection area of the

sensors again before a continuous tone sounds.  
Loud noises from outside and inside your vehicle may prevent you from hearing the PDC signal tone. ◀

**▶** Do not apply high pressure spray to the sensors for a prolonged period of time. Keep the spray at least 4 in/10 cm away from the sensors. ◀

## Driving stability control systems

Your BMW is equipped with an extended array of systems designed to enhance and maintain vehicle stability under extreme conditions.

### ABS Antilock Brake System

ABS prevents the wheels from locking during braking. Safe steering response is maintained even during hard braking. This increases active driving safety.

ABS is operational every time you start the engine. For information on safe braking, refer to page 109.

### CBC Cornering Brake Control

This system provides further enhancements to vehicle stability and steering response when braking while cornering or when braking during a lane change.

### Electronic brake-force distribution

This system controls the brake system's application pressure at the rear wheels to ensure stable deceleration.

### DBC Dynamic Brake Control

When you apply the brakes rapidly, this system automatically produces the maximum braking force boost and thus helps to achieve the shortest possible braking distance during panic stops. This system exploits all of the benefits provided by ABS.

Do not reduce the pressure on the brake pedal for the duration of the brake application. When the brake pedal is released, DBC is deactivated.

### DSC Dynamic Stability Control

The system prevents slip at the drive wheels when driving off and accelerating. DSC also detects unstable driving conditions such as fishtailing or sliding of the front wheels. In these cases DSC helps the vehicle safely stay on course within the physical limits by reducing the engine output and through braking actions in the individual wheels.

The DSC is operational every time you start the engine.

 The laws of physics cannot be repealed, even with DSC. An appropriate driving style always remains the responsibility of the driver. Therefore, do not reduce the additional safety margin again by taking risks. ◀

### DTC Dynamic Traction Control

DTC is a variant of DSC for special road conditions, e.g. uncleared snow-covered roads, that is optimized for forward momentum. The system ensures maximum forward momentum, but with limited driving stability. Therefore, drive with the corresponding caution.

You may find it useful to briefly activate DTC under the following special circumstances:

- ▷ When driving on snow-covered uphill grades, in slushy snow or on uncleared, snow-covered roads
- ▷ When rocking a stuck vehicle free or when starting off in deep snow or on loose ground
- ▷ When driving with snow chains\*

### Activating DTC



Press the button; the DTC indicator lamp in the instrument cluster lights up.

### Deactivating DTC again

Press the button again; the DTC indicator lamp in the instrument cluster goes out.

### Deactivating DTC and DSC together



Press the button until the DSC indicator lamp in the instrument cluster lights up, however not longer than approx. 10 seconds. Interventions promoting stability and forward momentum will no longer be carried out. In addition, the stability promoting intervention of the active steering\* is deactivated, refer to page 85.

A message appears on the Control Display. Please note any supplementary information that appears there.

To support enhanced operating stability, reactivate DSC again as soon as possible.

### Reactivating DSC

Press the button; the indicator lamp in the instrument cluster goes out.

## To control



The indicator lamp flashes: DSC or DTC controls the drive forces and brake forces.

The indicator lamp comes on: DSC and DTC are deactivated together via the button DTC.



The indicator lamp comes on: DTC is activated via the DTC button.

## Malfunction in the driving-stability control systems



The brake system warning lamp lights up in red, appearing together with the indicator lamps for ABS and DSC. A



message appears on the Control Display. The driving-stability control systems have failed. Conventional braking efficiency remains available without limitations.



While you may continue, you should remember to proceed cautiously and drive defensively while avoiding full brake applications. Have the system checked as soon as possible.



Display of the previously described malfunction on Canadian models.



The DSC indicator lamp lights up. A message appears on the Control Display. A malfunction has occurred in DSC and DTC.

The stability maintenance functions are no longer available. The vehicle remains operational.

Have the system checked as soon as possible.



The warning lamp for the brake system lights up in yellow. A message appears on the Control Display. DBC has failed.

Have the system checked as soon as possible.



Display of the previously described malfunction on Canadian models.

## Active roll stabilization\*

### The concept

Active roll stabilization minimizes body roll and optimizes vehicle stability during cornering and evasive maneuvers.

Dynamic stabilizers at the front and rear axles form the basis for active roll stabilization. Suspension compliance adapts to suit driving conditions, varying from performance-oriented during cornering to smooth and comfort-oriented when the vehicle is proceeding in a straight line. During vehicle operation, the system continuously runs through closed-loop control cycles lasting only fractions of a second.

The system assumes operational status each time you start the engine.

### Malfunction



The warning lamp lights up and a message appears on the Control Display.

There is a malfunction in the system.

Have the system checked as soon as possible.



If there is a malfunction in the system, please remember to adapt your speed accordingly, especially in curves.

The suspension will be noticeably softer and the vehicle will display a greater tendency to tilt during cornering and in crosswinds.

If a message stating that you should stop appears on the Control Display, stop and switch off the engine as soon as possible. In this case the oil level in the reservoir may have dropped below the minimum, possibly owing to a leak in the hydraulic system. Do not continue driving. Contact your BMW center. ◀

## Flat Tire Monitor

### The concept

The Flat Tire Monitor keeps track of the inflation pressures in the four tires as you drive. The system provides an alert whenever the inflation pressure drops significantly in relation to the pressure in another tire.

When a loss of pressure occurs, the rolling radius changes and with it, the rotational speed of the wheels. This change is detected and signaled as a flat tire.

### Functional requirement

To ensure the reliable signaling of a flat tire, the system must be initialized at the correct tire inflation pressure.

▶ The initialization must be repeated after every correction of the tire inflation pressure and after every tire or wheel change. ◀

### System limits

⚠ The Flat Tire Monitor cannot indicate sudden severe tire damage caused by outside factors and does not detect a natural, even pressure drop in all four tires. ◀

In the following situations, the system could be delayed or malfunction:

- ▶ System has not been initialized
- ▶ Driving on snow-covered or slippery roads
- ▶ Sporty driving style: slip in the drive wheels, high lateral acceleration
- ▶ When driving with snow chains\*

### Initializing system

▶ The initialization is completed during driving, which can be interrupted at any time. When driving continues, the initialization is also automatically continued.

Do not initialize the system when driving with snow chains\*. ◀

Control Center, for principle details, refer to page 16.

1. Press the **MENU** button  
This opens the start menu.



2. Press the controller to open the **i** menu.
3. Select "Vehicle settings" and press the controller.
4. Select "FTM" and press the controller.



5. Start engine, but do not start driving.
6. Select "Set tire pressure" and press the controller.

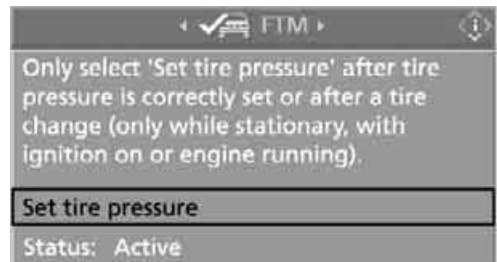

7. Select "Yes" and press the controller.
8. Release.  
The message "Initializing" is displayed.  
The initialization is completed during driving. Then "Status: Active" appears on the Control Display again.

## Report of a flat tire



The warning lamp lights up in red. A message appears on the Control Display. In addition, an acoustic signal sounds. There is a flat tire or extensive inflation pressure loss.

1. Cautiously reduce the vehicle speed to below 50 mph/80 km/h. Avoid sudden braking and steering maneuvers. Do not exceed a vehicle speed of 50 mph/80 km/h.



If the vehicle is not, as provided at the factory, equipped with run-flat tires, refer to page 172, stop driving. Continued driving after a flat tire can result in serious accidents. ◀

2. Check the air pressure in all four tires at the next opportunity.



If the tire inflation pressure in all four tires is correct, the Flat Tire Monitor may not have been initialized. The system must then be initialized. ◀

3. In case of a complete loss of the tire inflation pressure or obvious tire damage, you can estimate the possible driving distance for continued driving base on the following reference values:

- ▷ With low load:
  - 1 to 2 persons without luggage: approx. 155 miles/250 km.
- ▷ With medium load:
  - 2 persons, luggage compartment full, or 4 persons without luggage: approx. 94 miles/150 km.
- ▷ With full load:
  - 4 persons, luggage compartment full: approx. 30 miles/50 km.



Drive reservedly and do not exceed a speed of 50 mph/80 km/h. In the event of pressure loss, vehicle handling changes. This includes reduced tracking stability in braking, extended braking distance and altered natural steering characteristics.

If unusual vibrations occur while the vehicle is being driven, this can indicate final failure of the damaged tire. Reduce speed and

stop as soon as possible. Do not continue driving. Contact your BMW center. ◀

## Malfunction



The warning lamp lights up in yellow. A message appears on the Control Display. The Flat Tire Monitor has a malfunction or has failed. Have the system checked as soon as possible.

## Active steering\*

### The concept

The active steering is a system that actively varies the steering angle of the front wheels in relation to the steering wheel movements.

At low speed, e.g. in a town or when parking, the steering angle of the wheels is reinforced, i.e. the steering becomes very direct.

In the higher speed range, on the other hand, the steering angle is reduced more and more. This improves the handling capability of your BMW over the entire speed range.

In critical situations, the system can make targeted corrections to the steering angle provided by the driver and thus stabilize the vehicle before the driver intervenes. This stability-promoting intervention is deactivated when DSC is switched off, refer to page 82.

### Malfunction



The warning lamp lights up. The active steering is no longer operational. At low speed, larger steering wheel movements are required, while the vehicle reacts more sensitively to steering wheel movements in the higher road-speed range. Have the system checked.

If the warning lamp lights up during the first engine starting following a power supply interruption, the system must be activated by being initialized.

## Initializing system

1. Start the engine.
2. With the vehicle stationary, turn the steering wheel from the straight-ahead position to the left as far as it will go and then back to the straight-ahead position.
3. Switch off the engine.

When you start the engine again, all the functions of the active steering will be available once again.

## Brake Force Display

The Brake Force Display lights up in two stages depending on how strongly you brake.



- ▷ Normal braking:  
The brake lamps and the third brake lamp go on.
- ▷ Heavy braking and braking with ABS:  
In addition, the illuminated area of the rear brake lamps is enlarged, refer to illustration.

## Airbags

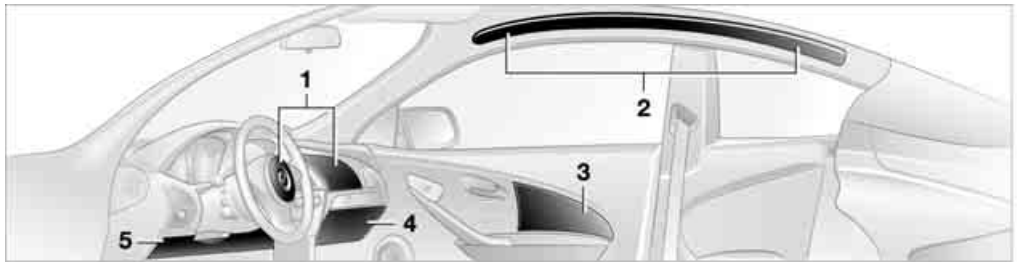

The following airbags are located under the marked covers:

- 1 Front airbags for driver and front passenger
- 2 Coupe: Head airbags
- 3 Front side airbags
- 4 Knee airbag for front passenger
- 5 Knee airbag for driver

The front airbags help protect the driver and front passenger by responding to frontal impacts in which safety belts alone cannot provide adequate restraint. When needed, the head and side airbags help provide protection in the event of a side impact. The side airbag supports the side upper body area. The head air bag supports the head.

The airbags are deliberately not triggered in every impact situation, e.g. less severe accidents, certain rollover conditions, or rear-end collisions.

For information on the correct sitting position, refer to page 44.

## Protective action

 To ensure that the safety systems continue to provide optimized protection, please observe the adjustment instructions on page 44. ◀



**⚠** Do not apply adhesive materials to the cover panels of the airbags, cover them or modify them in any other way. Do not attempt to remove the airbag retention system from the vehicle. Never modify or tamper with either the wiring or the individual components in the airbag system. This category includes the upholstery in the center of the steering wheel, on the instrument panel, the side trim panels on the doors and on the Coupe, the roof pillars along with the sides of the headliner. Do not attempt to remove or dismantle the steering wheel.

Do not touch the individual components directly after the system has been triggered, because there is a danger of burns. If you note any indication of system malfunction, if you wish to have an airbag deactivated, or if the airbag retention system is triggered in response to an accident, you should always entrust all inspection, repair and dismantling operations to your BMW center. Unprofessional attempts to service the system could lead to failure in an emergency or undesired airbag activation, either of which could result in personal injury. ◀

Airbag warning information is also provided on the sun visors.

## Operational readiness of airbag system



From ignition key position 1 the warning lamp lights up briefly, indicating the operational readiness of the entire airbag system and the belt tensioners.

## Airbag system malfunction

- ▷ The warning lamp does not light up as of ignition key position 1.

- ▷ The warning lamp lights up continuously.

**⚠** Have the airbag system checked immediately if a malfunction occurs, as otherwise there is a danger of the system not responding in the expected manner to an impact occurring within its normal response range. ◀

## Convertible: Rollover protection system

The rollover protection system is automatically activated in the event of an accident or a critical driving situation, extreme inclination on the longitudinal or transverse axis, or loss of ground contact. The rollover bars located behind the rear head restraints are deployed within fractions of a second.

As a supplement to the rollover bar integrated into the windshield frame, the rollover protection system ensures that all vehicle occupants have the necessary headroom.

**⚠** Always keep the path of movement of the rollover protection system clear. In less severe accidents, you are protected by the fastened safety belt and, depending on the severity of the accident, the belt tensioner and the multistage airbag restraint system. ◀

## Lowering

If the protection function was not required after automatic activation, the rollover protection system can be lowered again. No tools are necessary for this purpose.

1. Press the release backward and hold in that position.





2. Press the rollover protection unit halfway down from above.
3. Let go of the release.
4. Press the rollover protection unit down until it snaps into place.



5. Use the same procedure for the second roll-over protection unit.

Have the rollover protection system checked after unexpected triggering.

**⚠** Never move the convertible top when the rollover protection system is raised.

No changes of any nature may be made to the individual components of the rollover protection system and wiring.

Work on the rollover protection system may only be performed at a BMW center. Unprofessional attempts to service the system can lead to failure or malfunction.

For a system check and to ensure long-term functioning, you must comply with the maintenance intervals of the service requirement display. ◀

## Head-Up Display\*

### The concept

With the Head-Up Display important information is projected into the driver's field of view, e.g. navigation instructions. This enables you to take in this information without looking away from the road.



### Switching on/off

Ignition key in position 2:

Press the button to activate or deactivate this system.



- 1 Navigation instructions
- 2 Display
  - ▷ Cruise control
  - ▷ Active cruise control
- 3 Speed

## Selecting displays

Control Center, for principle details, refer to page 16.

1. Press the **MENU** button.  
This opens the start menu.



2. Press the controller to open the **i** menu.
3. Select "Display settings" and press the controller.
4. Select "Head-Up Display selection" and press the controller.
5. Select desired information of Head-Up Display.



6. Press the controller.  
 The information appears on the Head-Up Display.

The setting is stored for the remote control currently in use.

## Adjusting brightness

The brightness of the display is automatically adapted to the ambient lighting conditions. However, you can change the base setting. With the low beams switched on, the brightness can also be adjusted with the serrated dial of the instrument lighting.

Control Center, for principle details, refer to page 16.

1. Open the **i** menu.
2. Select "Display settings" and press the controller.
3. Select "Brightness" and press the controller.



4. If necessary, move the controller to the left to select "Head-Up Display Offset".
5. Turn the controller until the desired setting is selected.

The setting is stored for the remote control currently in use.

## Notes

The discernibility of the displays in the Head-Up Display is influenced by:

- ▷ Sunglasses with certain polarization filters
- ▷ Certain seating positions
- ▷ Objects on the cover of the Head-Up Display
- ▷ Wet road surface and unfavorable lighting conditions

If the image is distorted, please have the base setting checked at a BMW center.

## Special windshield

The windshield is part of the system. The shape of the windshield complies with the requirements of the Head-Up Display to enable a precise display. A film in the windshield prevents the double images from being displayed. Only have a windshield replaced by a BMW center or a workshop which works with personnel trained in accordance with BMW specifications.

### Care instructions

You can find everything you need to know on this topic by consulting the Caring for your vehicle brochure.

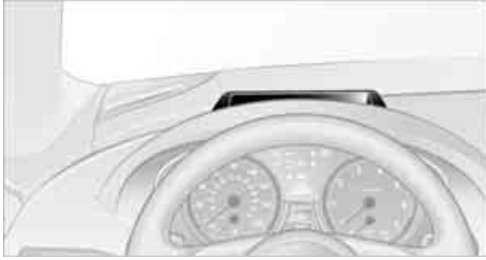

 Only clean the cover of the Head-Up Display with a soft, nonabrasive cloth or a display cleaning cloth, as otherwise damage may result. ◀

# Lamps

## Parking lamps/low beams

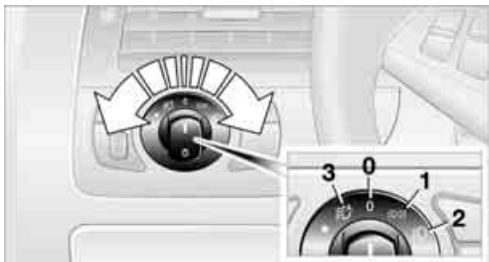

- 0 Lights off
- 1 Parking lamps
- 2 Low beams/daytime driving lamps\*
- 3 Automatic headlamp control/  
Adaptive Head Light\*

### Parking lamps

In the switch position **1**, the front, rear and side vehicle lighting is switched on. You can use the parking lamps for parking. For lighting on one side for parking as an additional feature, refer to page [92](#).

### Low beams

The low beams light up in switch position **2** only with the engine running. Otherwise the parking lamps are lit.

### Pathway lighting

After parking the vehicle and switching off the headlamps, operating the headlamp flasher activates the low beams. You can set the duration on the Control Display or deactivate the function.

Control Center, for principle details, refer to page [16](#).

1. Open the  menu.
2. Select "Vehicle settings" and press the controller.

3. Select "Light" and press the controller.



4. Select "Pathway lighting" and press the controller.
5. Turn the controller to select the corresponding duration.
6. Press the controller to apply the setting.

### Lights on warning

If you turn the ignition key to position **0**, an acoustic signal sounds when you open the driver's door for a few seconds to remind you that the lamps have not yet been switched off. At the same time a message appears on the Control Display.

### Daytime driving lamps\*

If you wish, you can leave the light switch in position **2**.

Always observe all applicable laws governing the use of daytime driving lamps.

You can switch on the parking lamps when needed using the standard procedure described under Parking lamps.

### Automatic headlamp control

In switch position **3** the low beams are automatically switched on or off depending on the ambient light, e.g. in a tunnel, at dawn/dusk in the rain or snow, and the Adaptive Head Light\* is active. The LED next to the symbol is illuminated when the low beams are on.

 The low beams remain on independent of the ambient lighting conditions when you switch on the fog lamps.

With the daytime driving lamps activated, the low beams are always switched on in this switch position with the ignition key in position 2. ◀

 The automatic headlamp control cannot serve as a substitute for your personal judgment in determining when the lamps should be switched on in response to ambient lighting conditions. For example, the system cannot detect fog. To avoid safety risks, you should always switch on the lamps manually under these conditions. ◀

## Adaptive Head Light\*

### The concept

Adaptive Head Light is a variable headlamp control system that enables better illumination of the road surface. Depending on the steering angle and other assumptions, the light from the headlamp follows the course of the road.

### Activating Adaptive Head Light

In switch position **3** the Adaptive Head Light is active and the automatic headlamp control is switched on.

To avoid blinding oncoming traffic, the Adaptive Head Light

- ▷ is not active when driving in reverse
- ▷ is only active toward passenger's side when stationary

### Malfunction

The LED beside the symbol for automatic headlamp control flashes. The Adaptive Head Light is malfunctioning or has failed. Have the system checked as soon as possible.

## High beams/ roadside parking lamps

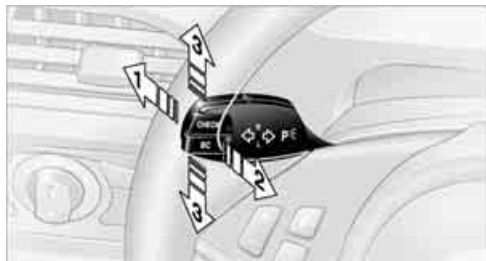

- 1 High beams
- 2 Headlamp flasher
- 3 Roadside parking lamps

### Roadside parking lamps, left or right\*

You also enjoy the option of lighting up just one side of your vehicle when parking. When using this function, comply with national regulations: With the ignition switched off, press the lever in the desired direction **3**, past the resistance point.

 The roadside parking lamps drain the battery. Avoid using for longer periods, as otherwise it may not be possible to start the engine. ◀

## Fog lamps



 The parking lamps or low beams must be switched on for the fog lamps to operate. The green indicator lamp in the instrument cluster lights up when the fog lamps are switched on.

The fog lamps are switched off whenever the high beams are switched on.

 If the automatic headlamp control is activated, the low beams will come on automatically when you switch on the fog lamps. ◀

## Instrument lighting



The lighting intensity can be adjusted with the serrated dial.

## Interior lamps

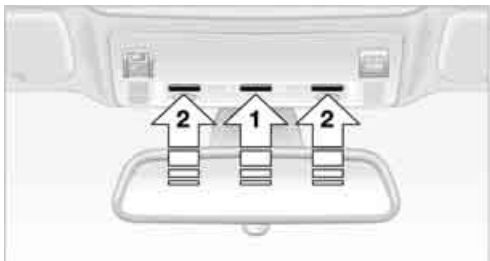

Control of the interior lamps, footwell lamps, door entry lighting, courtesy lamps\* and sill panel lighting\* is automatic.

### Switching the interior lamps on and off manually

Press button **1**.

If you want the interior lamps to remain off continuously, maintain pressure on the button for approx. 3 seconds.

To revert to normal operation, briefly press the button.

## Reading lamps

The reading lamps are beside the interior lamp. You can turn them on and off using the buttons **2** located next to the lamps.

 To avoid draining the battery, all of the vehicle's interior lamps are automatically switched off approx. 15 minutes after the ignition is switched off. ◀

# A congenial climate

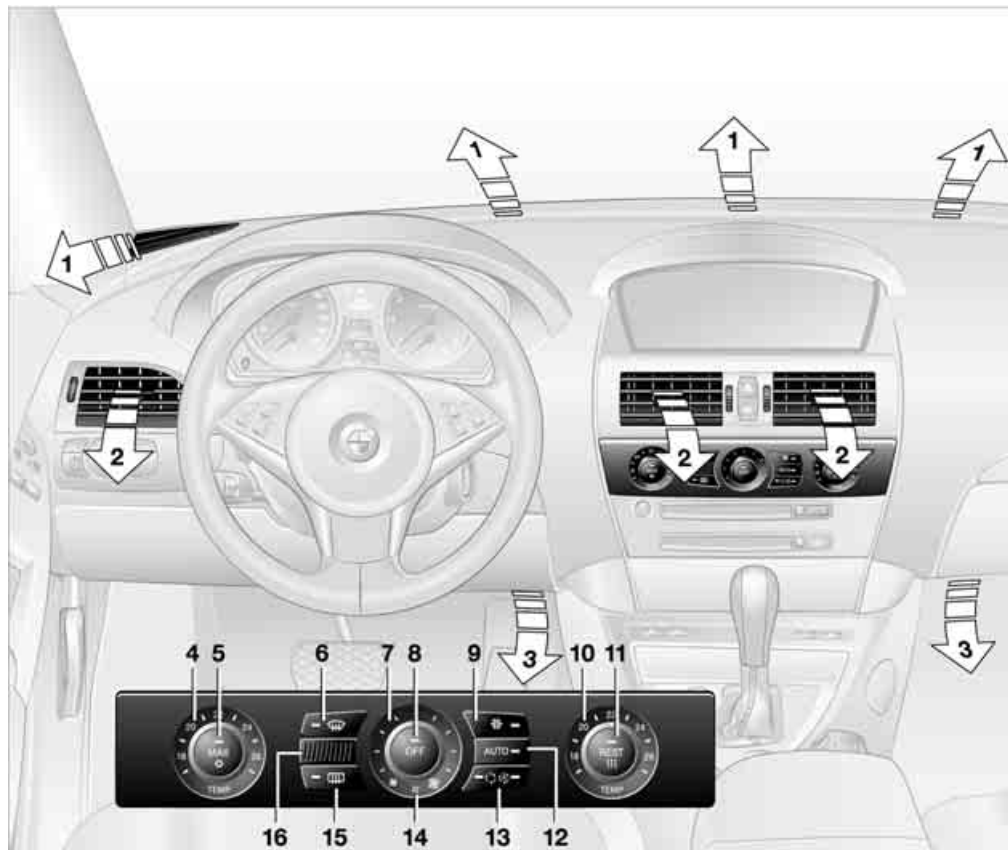

- |  |   |
|--|---|
| <p><b>1</b> Airflow directed toward the windshield and side windows</p> <p><b>2</b> Air for the upper body area, refer to Ventilation on page 97</p> <p><b>3</b> Air to footwell</p> <p><b>4</b> Temperature, left side of passenger compartment</p> <p><b>5</b> Maximum cooling</p> <p><b>6</b> Defrosting windows and removing condensation</p> <p><b>7</b> Air volume, manual</p> <p><b>8</b> Switching off automatic climate control</p> | <p><b>9</b> Switching cooling function on and off manually</p> <p><b>10</b> Temperature, right side of passenger compartment</p> <p><b>11</b> Residual heat mode</p> <p><b>12</b> AUTO program</p> <p><b>13</b> AUC automatic recirculated-air control/ recirculated air mode</p> <p><b>14</b> LED for independent ventilation</p> <p><b>15</b> Rear window defroster<br/>Convertible: only active when rear window is closed</p> <p><b>16</b> Air grill for interior temperature sensor – please keep clear and unobstructed</p> |
|--|---|

The current setting for air distribution is displayed on the Control Display.

## A congenial climate

For almost all conditions, the AUTO program offers the optimal air distribution and air volume. Select an interior temperature you find pleasant.

The following section contains more detailed information on the available setting options.

## AUTO program

 The AUTO program handles the adjustment of air distribution to the windshield and side windows, in the direction of the upper body, and in the footwell, as well as the adjustment of the air volume. It also adapts your instructions for the temperature to outside influences throughout the year. The cooling is switched on automatically with the AUTO program. At the same time, a condensation sensor controls the program in such a way that window condensation is prevented as much as possible.

## Temperature adjustment



By rotating, you can set a desired temperature for the driver's side and the passenger side.

After you start to drive, this system ensures that the selected temperature is achieved as quickly as possible. It then maintains this temperature, regardless of the season.

## Defrosting windows and removing condensation



This program quickly removes ice and condensation from the windshield and front side windows.

## Air volume, manual



You can adjust the air volume by turning. You can reactivate the automatic mode for the air volume with the AUTO button.

## Switching cooling function on and off manually



The cooling function cools and dehumidifies the incoming air before reheating it as needed according to the temperature setting. Depending on the weather, the windshield may fog over briefly when the engine is started.

The air conditioner can operate only when the engine is running. The AUTO program automatically switches on the air conditioner.

## Maximum cooling



This program quickly provides maximum cooling.

The system switches to the recirculated-air mode and the air flows at maximum air volume only from the vent outlets for the upper body area. For this reason you should ensure that these vent outlets are open before selecting this program.

## AUC automatic recirculated-air control/recirculated air mode



You can respond to unpleasant odors or pollutants in the immediate environment by temporarily suspending the supply of outside air. The system then recirculates the air currently within the vehicle. In AUC mode, a sensor detects pollutants in the outside air and controls the shut-off automatically.

Press the button repeatedly to run through the following control sequence:

- ▶ LED off: outside air flows into the vehicle continuously.
- ▶ Right LED on, AUC mode: the system detects pollutants in the outside air and responds by blocking the supply of outside air when required.
- ▶ Left LED on, recirculated-air mode: the supply of outside air into the vehicle is shut off continuously.

 If condensation starts to form on the inside window surfaces during operation in the recirculated-air mode, you should switch



it off while also increasing the air volume as required.  
 The recirculated-air mode should not be used over a longer period of time, as the air quality inside the vehicle deteriorates continuously. ◀

## Residual heat mode



Press the button when the motor is switched off and warm.

The heat stored in the engine is used to heat the passenger compartment, e.g. when stopped at a school to pick up a child.

You can adjust the automatic climate control settings as of ignition key position 1.

Provided that the engine has warmed to its normal operating temperature and the battery is charged, you can use this function for up to 15 minutes after switching off the ignition. The LED in the button lights up to confirm compliance with both of these conditions.

## Switching off automatic climate control



The air volume, the heater and the cooling function are all switched off.

You can restart the automatic climate control by pressing any of its buttons except the REST button.

## Settings using Control Center

Ignition key:

- ▷ In vehicles with separate drives for audio CDs and navigation DVDs, ignition key in position 2.
- ▷ In vehicles with one drive for audio CDs, ignition key in position 1.

Control Center, for principle details, refer to page 16.

1. Press the **MENU** button.  
This opens the start menu.



2. Move the controller to the left to open "Climate".

You can set the following:

- ▷ Manual air distribution, separate for driver's side and passenger side
- ▷ Adapting temperature in upper body region
- ▷ Intensity of the AUTO program

The settings are stored for the remote control currently in use.

## Manual air distribution

You can preset the air distribution yourself and also adjust the air temperature in the upper body area.

1. Select "Vent settings" and press the controller.
2. Select the desired field by moving the controller and turn the controller to adjust the air distribution.



- 1 Airflow directed toward the windshield and side windows, driver's side only
- 2 Airflow for the upper body
- 3 Air to footwell

To select the front passenger area:  
Move the controller to the right.

 Pressing the AUTO button raises and lowers the air distribution settings on the Control Display. ◀

## Adapting temperature in upper body region

1. Select "Vent settings" and press the controller.
2. Select the field by moving the controller and adjust the air distribution by turning the controller.



## Setting intensity of AUTO program

To meet your individual needs, you can weaken or strengthen the intensity of the automatic climate control.

1. Select "Automatic programs" and press the controller.

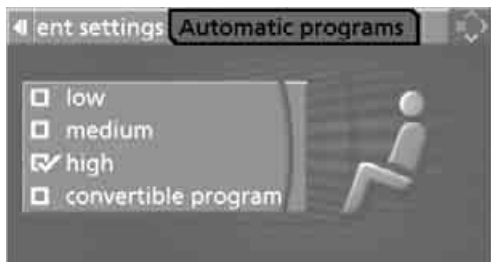

2. Select the desired intensity and press the controller.

## Convertible program

When the convertible top is opened, the convertible program can also be selected. In the convertible program, the automatic climate

control is optimized for driving with the convertible top open. In addition, the air supply is increased as the speed increases.

If the convertible program has been selected, it is automatically active every time the top is opened.

 The effect of the convertible program can be greatly enhanced if the wind deflector is installed. ◀

## Ventilation

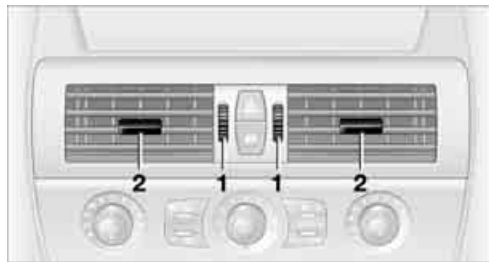

- 1 Serrated dial for smoothly opening and closing air vents
- 2 Lever for changing the airflow direction

 Do not drop any foreign bodies into the vent outlets, as otherwise these could be catapulted outwards and lead to injuries. ◀

## Ventilation for cooling

Adjust the vent outlets to direct the flow of cool air in your direction, for instance, if the interior has become too warm, etc.

## Draft-free ventilation

Set the vent outlets so that the air flows past you and is not directed straight at you.

## Microfilter/activated-charcoal filter

The microfilter removes dust and pollen from the incoming air. The activated-charcoal filter provides additional protection by filtering gaseous pollutants from the outside air. Your BMW center replaces this combined filter as a standard part of your scheduled maintenance.

You can have more detailed information shown on the Control Display, refer to page 70.

## Independent ventilation

The independent ventilation blows air into the passenger compartment to lower interior temperatures.

The independent ventilation is controlled using the Control Center. You can set two different times for the system to start.

The independent ventilation remains on for 30 minutes. It can also be switched on and off directly. Since the system uses a substantial amount of electrical current, you should refrain from activating it twice in succession without allowing the battery to be recharged in normal operation between use.

The independent ventilation is ready for use at any outside temperature up to ignition key position 1.

The air emerges through the upper body region vent outlets in the instrument panel. These vent outlets must be open for the system to operate.

### Switching on and off directly

Ignition key in position 2:

Control Center, for principle details, refer to page 16.

1. Open "Climate".
2. Select "Parked car operation" and press the controller.
3. Select "Automatic ventilation" and press the controller.
4. Select "Parked car ventilation" and press the controller.

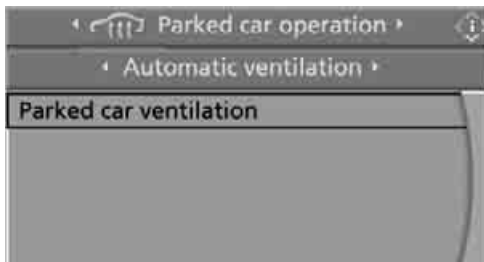

The independent ventilation is switched on and the LED  flashes.

### Preselecting activation times

Ignition key in position 2:

Control Center, for principle details, refer to page 16.

1. Open "Climate".
2. Select "Parked car operation" and press the controller.
3. Select "Activation time" and press the controller.

 If you select two activation times that are in sequence, they must differ by at least 31 minutes. ◀

4. Move the controller to the left or right to select "Time 1" or "Time 2".
5. Select the time and press the controller. The first time setting is highlighted.

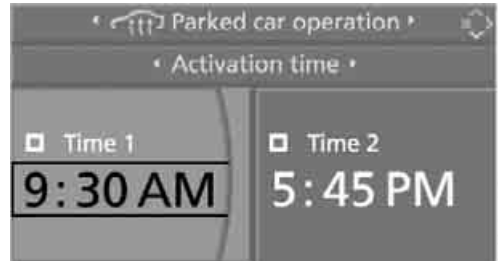



6. Turn the controller to make the adjustment.
7. Press the controller to apply the setting. The next adjustment is highlighted.
8. Make the remaining adjustments. After the last adjustment, the time is stored.

### Activating an activation time

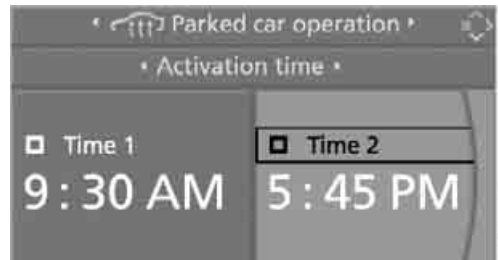
Move the controller to the left or right to select "Time 1" or "Time 2" and press the controller.



 The activation time is activated and the LED lights up.

 The independent ventilation is only available for activation within the subsequent 24 hours. After that, the time must be reactivated. ◀

# Practical interior accessories

## Integrated universal remote control\*

### The concept

The integrated universal remote control replaces up to three different hand-held transmitters for various items of radio-controlled equipment such as door openers and house alarm systems. The integrated universal remote control registers and stores signals from the original hand-held transmitters.

The signal of an original hand-held transmitter can be programmed into one of the three memory buttons **1**. Then the respective device can be actuated using the memory button **1** programmed for its use when the ignition key is in position **2**. The LED **2** flashes to confirm transmission of the signal.

If you sell your vehicle one day, delete the saved programs beforehand for your own security, refer to page 101.

 To prevent possible damage or injury, before programming or using the integrated universal remote control, always inspect the immediate area to make certain that no people, animals or objects are within the travel range of the device. Also comply with the safety precautions of the original hand-held transmitter. ◀

### Checking compatibility

 If you see this symbol on the packaging or in the manual supplied with the original hand-held transmitter, it is safe to assume that it is compatible with the integrated universal remote control.

If you have additional questions, please consult your BMW center or call 1-800-355-3515.

You can also visit these websites:

[www.bmwusa.com](http://www.bmwusa.com) or

[www.homelink.com](http://www.homelink.com).

HomeLink is a registered trademark owned by Johnson Controls, Inc.

## Programming

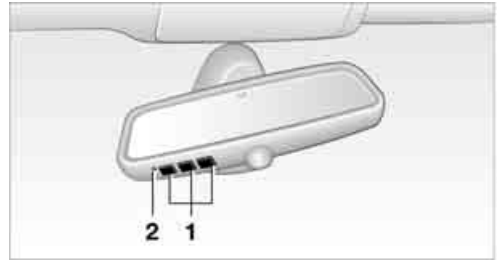

- 1 Memory buttons
- 2 LED

### Fixed-code hand-held transmitters

1. Ignition key in position 2.
2. When using for the first time: press both outer buttons **1** for approx. 20 seconds, maintaining pressure until the LED **2** starts to flash. The three memory buttons **1** are cleared.
3. Hold the original hand-held transmitter at a distance of approx. 2 in/5 cm to 8 in/20 cm to the memory buttons **1**.

 The required distance between the hand-held transmitter and the memory buttons **1** depends on the respective system of the original hand-held transmitter used. ◀

4. Simultaneously press the transmit button on the original hand-held transmitter and the desired memory button **1** on the integrated universal remote control. Initially, the LED **2** flashes slowly. Release both buttons as soon as the LED **2** flashes rapidly. If the LED **2** does not flash rapidly after approx. 15 seconds, change the distance.
5. To program other original hand-held transmitters, repeat steps 3 and 4.

The corresponding memory button **1** is now programmed with the signal of the original hand-held transmitter.

You can operate the system when the ignition key is in position 2.

 If the device cannot be used after repeated programming, check whether the original hand-held transmitter uses an alternating-code system. To do so, either read the instructions for the original hand-held transmitter or press the programmed memory button **1** of the integrated universal remote control longer. If the LED **2** on the integrated universal remote control flashes rapidly for a short time then lights up for approx. 2 seconds, this indicates that the original hand-held transmitter uses an alternating-code system. In the case of an alternating-code system, program the memory buttons **1** as described at Alternating-code hand-held transmitters. ◀

### Alternating-code hand-held transmitters

To program the integrated universal remote control, consult the operating instructions for the equipment to be set. You will find information there on the possibilities for synchronization.

When programming hand-held transmitters that employ an alternating code, please observe the following supplementary instructions:

 Programming will be easier with the aid of a second person. ◀

1. Park your vehicle within the range of the remote-controlled equipment.
2. Program the integrated universal remote control as described above at Fixed-code hand-held transmitters.
3. Locate the button at the receiver of the equipment to be set, e.g. on the drive.
4. Press the button on the receiver of the equipment to be set. After step 4, you have approx. 30 seconds for step 5.
5. Press the programmed memory button **1** of the integrated universal remote control three times.

The corresponding memory button **1** is now programmed with the signal of the original hand-held transmitter.

### Clearing memory buttons

Press both outer buttons **1** for approx. 20 seconds, maintaining pressure until the LED **2** starts to flash: All of the memory buttons are cleared.

The memory of individual memory buttons **1** cannot be cleared.

## Glove compartment

### Opening

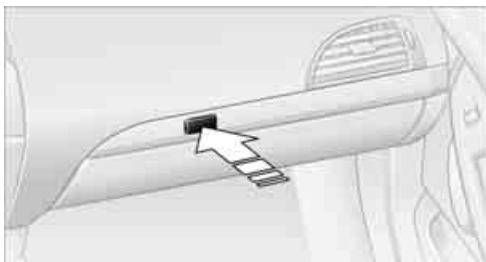

Press the button. The glove compartment opens automatically and the lamps come on.

### Closing

Fold the cover up.

 To prevent injury in the event of an accident while the vehicle is being driven, close the glove compartment immediately after use. ◀

### Rechargeable flashlight\*

The flashlight is located on the left side of the glove compartment.

The flashlight can remain there continuously.

 Be sure that the flashlight is switched off when it is inserted into its holder. Failure to comply with this precaution could lead to overcharging and damage. ◀

## Center armrest

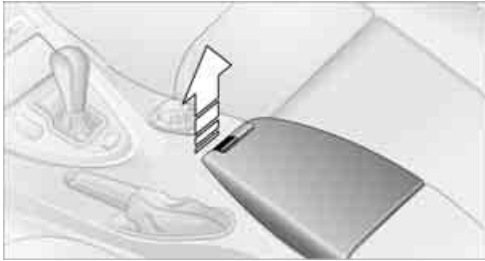

A storage compartment is located in the armrest between the front seats. This compartment is integrated into the central locking system and can also be locked separately using the hotel function, refer to page 32.

To open the cover:

Pull the left button. The cover opens and can be folded upward.

Depending on the version, the storage compartment can be equipped with a corresponding cradle\* for the telephone or portable phone.

### Adjusting height

The center armrest can be set in 2 positions.



Pull the right button:

Move the armrest upward or downward and lock it in the desired position.

## Storage compartments

### Storage compartment behind center armrest

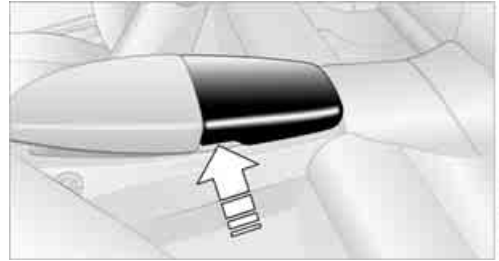

To open, raise the cover at the left or right edge. The compartment contains the cup holder and the lock for the hotel function, refer to page 32.

### Other compartments and nets

Other compartments are provided in the doors as well as in the front center console\*.

Ticket pockets are located in the sun visors.

Storage nets are located on the backrests of the front seats and in the passenger footwell\*.

Another storage space is located in the luggage compartment in the right side panel. If you wish, this is also suitable for storing the onboard documentation.

### Coupe: clothes hooks

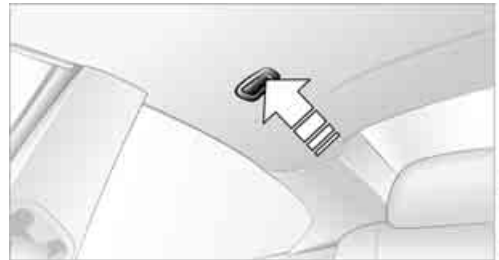

To fold down, press at the top edge.

**⚠** When suspending clothing from the hooks, ensure that it will not obstruct the driver's vision. Do not hang heavy objects on the hooks. If you do so, they could cause personal injury to occupants during braking or evasive maneuvers. ◀

## Cup holders



The compartment of the rear center console contains a built-in and removable cup holder.



The removable cup holder can be inserted into the side of the center console.

**⚠** Do not place glass containers in the cup holders. This would lead to an increased risk of injury in the event of an accident. ◀

## Ashtray

### Opening

Press the trim strip of the cover.

## Emptying



Press the opened cover beyond the resistance point, refer to arrow:  
The ashtray lifts up for removal.

## Cigarette lighter



In ignition key position 2, press in the cigarette lighter.

The lighter can be removed as soon as it pops back out.

**⚠** Hold or touch the hot cigarette lighter by the knob only. Holding or touching it in other areas could result in burns. Always remove the ignition key when you leave the vehicle so that, for example, children are unable to use the cigarette lighter and burn themselves. ◀

## Socket

When the ignition key is in position 2, the lighter socket can be used to plug in hand flashlights, car vacuum cleaners, etc., with power ratings of up to approx. 200 W at 12 V. Avoid damaging the socket due to inserting plugs of different shapes or sizes.



## Socket

### In front passenger footwell



Access to the socket:  
Fold the cover upward.

## Ski bag\*

It permits safe and clean transport of up to two pairs of standard skies or one snowboard.

You can use the ski bag to stow skis up to 6.9 ft/ 2.10 m long.

### Loading

1. Press the button downward and pull the filler element forward.



2. Extend the ski bag between the front seats. The zipper gives you easy access to stowed items and facilitates drying of the ski bag.

3. Press the button in the luggage compartment.

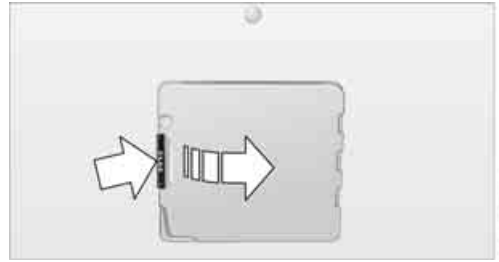

4. Open the loading flap and use the magnetic holder to secure it to the rear panel.

To store the ski bag, perform the above steps in reverse order.

Make sure to load only clean skis into the ski bag. Wrap sharp edges so that no damage occurs.

### Securing cargo

After loading, secure the ski bag and its contents. To do so, tighten the retaining belt at the buckle.



Secure the ski bag in this way. If you fail to do so, it could move around and endanger occupants during braking or evasive maneuvers.

To refit the filler element, insert the two tabs at the bottom into the strip and press the filler element back into place. Make sure that you do not damage the rear seat upholstery. ◀





## **Driving tips**

This section is designed to provide you with extra support by supplying information useful in dealing with specific driving and operating conditions.

# Things to remember when driving

## Breaking-in

Moving parts need time to adjust to one another. To ensure that your vehicle continues to provide optimized economy of operation throughout an extended service life, we request that you devote careful attention to the following section.

## Engine and differential

Up to 1,200 miles/2,000 km:

You should attempt to vary both vehicle and engine speeds. Until the break-in period has been completed, you should also refrain from exceeding an engine speed of 4,500 rpm or a driving speed of 100 mph/160 km/h.

Always obey all official speed limits.

Avoid full-throttle operation and use of the transmission's kick-down mode during these initial miles.

Once you have driven 1,200 miles/2,000 km, the engine and vehicle speeds can be gradually increased.

## SMG Sequential manual transmission

Do not use the acceleration assistant during the break-in period, refer to page 59.

## Tires

Due to technical factors associated with their manufacture, tires do not achieve their full traction potential until after an initial break-in period. Therefore, drive reservedly during the first 200 miles/300 km.

## Brake system

Brakes require an initial break-in period of approx. 300 miles/500 km to achieve optimized contact and wear patterns between brake pads and rotors.

## Clutch

The function of the clutch is only at its optimized level after a distance driven of approx. 300 miles/500 km. During this break-in period, engage the clutch gently.

## After component replacement

You should also comply with these break-in procedures should the components mentioned above need to be replaced at a later point.

## General driving notes

### Close the luggage compartment lid

 Operate the vehicle only when the luggage compartment lid is completely closed. Otherwise, exhaust fumes could penetrate to the interior of the vehicle. ◀

If special circumstances should make it absolutely necessary to operate the vehicle with the luggage compartment lid open:

1. Coupe: close both windows and the glass sunroof.  
Convertible: with closed top, close all windows.
2. Adjust the automatic climate control to supply a high air volume, refer to page 95.

### Hot exhaust system

 As in all vehicles equipped with a catalytic converter, extremely high temperatures are generated in this vehicle. Do not remove the heat shields installed adjacent to various sections of the exhaust system, and never apply undercoating to them. When driving, standing at idle and while parking, take care to avoid possible contact between the hot exhaust system and any highly flammable materials such as hay, leaves, grass, etc. Such contact could lead to a fire, and with it the risk of serious property damage as well as personal injury. ◀

## Mobile communication devices in vehicle

 BMW advises against using mobile communication devices, e.g. portable phones, inside the vehicle without a direct connection to an external antenna. Otherwise, the vehicle electronics and mobile communication device can influence one another. In addition, there is no assurance that the radiation emitted during transmission will be conveyed out of the vehicle interior. ◀

## Hydroplaning

 When driving on wet or slushy roads, reduce road speed. If you do not, a wedge of water can form between tires and road surface. This phenomenon is referred to as hydroplaning, and is characterized by a partial or complete loss of contact between the tires and the road surface, ultimately undermining your ability to steer and brake the vehicle. ◀

The risk of hydroplaning increases as the tread depth of the tires decreases, also refer to Minimum tire tread on page 171.

## Driving through water

 Do not drive through water on the road if it is deeper than 1 ft/30 cm, and then only at walking speed at the most. Otherwise, the vehicle's engine, the electrical systems and the transmission may be damaged. ◀

## Using handbrake on inclines.

 On inclines, do not hold the vehicle with the clutch; use the handbrake. Otherwise greater clutch wear will result. ◀

## SMG Sequential manual transmission

 Start off quickly on slopes. Do not hold the vehicle on a hill by applying the throttle, but engage the handbrake instead. Otherwise overheating can occur in the transmission region. ◀

## Braking safely

Your BMW is equipped with ABS as standard. In situations that require it, it is best to brake with full force. Since the vehicle maintains steering responsiveness, you can still avoid possible obstacles with a minimum of steering effort.

Pulsation at the brake pedal combines with sounds from the hydraulic circuits to indicate to the driver that ABS is in its active mode.

 Do not drive with your foot resting on the brake pedal. Even light but consistent pedal pressure can lead to high temperatures, brake wear and possibly even brake failure. ◀

## Driving in wet conditions

When driving on wet roads or in heavy rain, briefly brake with light pedal pressure at intervals of a few miles. Monitor traffic conditions to ensure that this maneuver does not endanger other road users. The heat generated in this process helps dry the pads and rotors to ensure that full braking efficiency will then be available when you need it.

## Hills

 To prevent overheating and thus reduced efficiency of the brake system, downshift to a gear in which only minimal brake applications are needed when descending long or steep downhill stretches. Even light but consistent pedal pressure can lead to high temperatures, brake wear and possibly even brake failure. ◀

You can further enhance the engine's braking effect by selecting a lower gear in the automatic transmission's manual mode, downshifting as far as first gear on extremely steep stretches, refer to page 58. This strategy helps you avoid placing excessive loads on the brake system.

 Never drive with the clutch pressed or allow the vehicle to coast with the transmission in Neutral – or with the engine switched off – there is no engine braking when the transmission is in Neutral, and no power assist for brakes and steering when the engine is not running.

Never allow floor mats, carpets or any other objects to protrude into the area around the accelerator and brake pedals and obstruct their movement. ◀

### Corrosion on brake rotors

When the vehicle is driven only occasionally, during extended periods when the vehicle is not used at all, and in operating conditions where brake applications are less frequent, there is an increased tendency for corrosion to form on rotors, while contaminants accumulate on the brake pads. This occurs because the minimum pressure which must be exerted by the pads during brake applications to clean the rotors is not reached.

Should corrosion form on the brake rotors, the brakes will tend to respond with a pulsating effect that even extended application will fail to cure.

### When the vehicle is parked

Condensation forms in the automatic air conditioner system during operation, and then exits under the vehicle. Traces of condensed water under the vehicle are therefore normal.

### Before driving into a car wash

 To prevent the exterior mirrors from being damaged due to the width of the vehicle, always fold them in by hand before entering an automatic car wash. ◀

### Cargo loading

 To avoid loading the tires beyond their approved carrying capacity, never overload the vehicle. Overloading can lead to overheating and increases the rate at which damage develops inside the tires. The ultimate result can assume the form of a sudden blow-out. ◀

### Determining loading limit



1. Locate the following statement on your vehicle's placard\*:  
 The combined weight of occupants and cargo should never exceed XXX lbs. or YYY kg, as otherwise the vehicle may be damaged and unstable driving conditions may result. ◀
2. Determine the combined weight of the driver and passengers that will be riding in your vehicle.
3. Subtract the combined weight of the driver and passengers from XXX lbs. or YYY kg.
4. The resulting figure equals the available amount of cargo and luggage load capacity. For example, if the XXX amount equals 800 lbs. and there will be four 150-lbs. passengers in your vehicle, the amount of available cargo and luggage load capacity is 200 lbs.:  
 $800 \text{ lbs.} - 600 \text{ lbs.} = 200 \text{ lbs.}$
5. Determine the combined weight of luggage and cargo being loaded on the vehicle. That weight may not safely exceed the available cargo and luggage load capacity calculated in step 4.
6. If your vehicle will be towing a trailer, part of the load from your trailer will be transferred to your vehicle. Consult the manual for transporting a trailer to determine how this may reduce the available cargo and luggage load capacity of your vehicle.

## Load

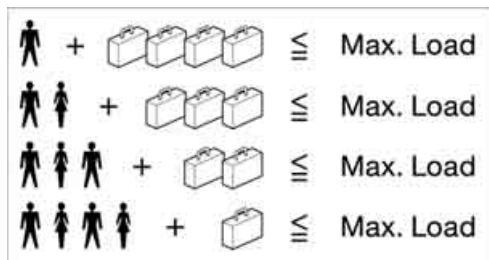

The permitted load is the total of the weight of occupants and cargo/luggage. The greater the weight of occupants, the less cargo/luggage can be transported.

## Stowing cargo

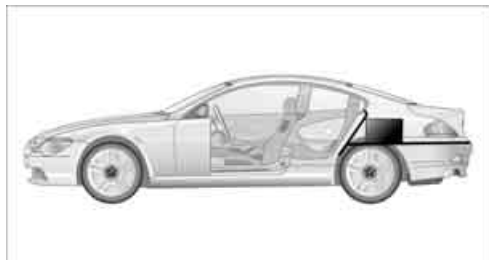

- ▶ Load heavy cargo as far forward and as low as possible, placing it directly behind the bulkhead behind the rear seats.
- ▶ Cover sharp edges and corners.

## Securing cargo

- ▶ Use the luggage net\* or securing straps to hold down small and lightweight luggage and cargo.

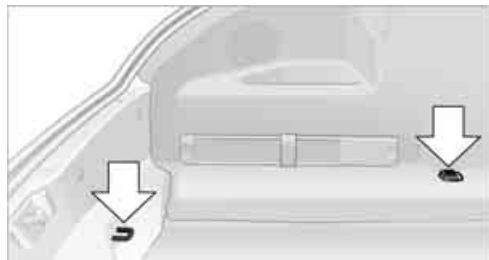

- ▶ Heavy-duty cargo straps\* for securing larger and heavier objects are available at your BMW center. Four lashing eyes mounted in the luggage compartment are used to secure these heavy-duty cargo straps, refer to arrows.
- ▶ Please observe the special instructions supplied with the heavy-duty cargo straps.

 Always position and secure the load as described above, otherwise it may present a danger to passengers during braking or evasive maneuvers.

Never exceed either the approved gross vehicle weight or either of the approved axle loads, refer to page 192, as excessive loads can pose a safety hazard, and may also place you in violation of freeway safety laws.

You should never transport heavy or hard objects unsecured in the passenger compartment, as they could fly around and pose a safety hazard to the vehicle's occupants during abrupt braking or evasive maneuver. ◀

## Pad on bottom of luggage compartment

If required, you can use the pad e.g. to transport dirty or soiled objects. The rubberized side is washable and has an anti-slip effect.







## Navigation

This chapter describes how you can enter destinations and specify your route so that your navigation system guides you reliably to your destination.

# Starting navigation system\*

Your navigation system can use satellites to ascertain the precise position of your vehicle and guide you reliably to any destination you enter.

## Navigation DVD

Special navigation DVDs are required for each navigation system. You can obtain the latest version at your BMW center.

## Inserting navigation DVD



1. Insert the navigation DVD with the labeled side up.
2. Allow approx. 8 seconds for the system to scan the data from the DVD.

## Removing navigation DVD

1. Press button 1.  
The DVD emerges slightly from the drive.
2. Remove the DVD.

## Display in assistance window

You can display the route or the current position in the assistance window. This display remains visible even if you switch to another application.

1. Move the controller to the right to enter the assistance window.



2. Press the controller.  
Other menu items are displayed.
3. Select the desired view of the route or "Current position".



4. Press the controller.

The contents of the assistance window are continually updated as you drive.

# Destination entry

In entering your destination you can select from among the following options:

- ▷ Manual entry of destination, see below
- ▷ Select destination using information, refer to page 118
- ▷ Select from among recent destinations, refer to Destination list, page 119
- ▷ Select destination from address book, refer to page 120.
- ▷ Select home address, refer to page 122

After selecting your destination you can proceed to start the destination guidance, refer to page 124.

## Operating navigation system

 Enter data only when the vehicle is stationary, and always obey the traffic regulations and road signs in the event of any contradiction between traffic and road conditions and the instructions issued by the navigation system. If you do not observe this precaution, you may be in violation of the law, and can endanger vehicle occupants and other road users. ◀

Control Center, for principle details, refer to page 16.

1. Press the **MENU** button.  
This opens the start menu.



2. Move the controller to the right to open "Navigation".

3. Select "Navigation" and press the controller.



## Entering a destination manually

The system supports the word matching principle to make it easier for you to enter the names of streets or towns/cities. This enables input of different spellings and supplements your input automatically so that stored city and street names can be applied as destinations as quickly as possible.

Control Center, for principle details, refer to page 16.

1. Select "Navigation" and press the controller.
2. Select "New destination" and press the controller.



3. Select "Enter address" and press the controller.



The system also supports you with the following features:

- ▷ If you do not enter a street, the system will guide you to the downtown area of a town or city.
- ▷ You can skip the entry of country and locality if the current entries are being retained for your new destination
- ▷ The commands of the voice command system for destination entry differ from those of the individual menu items on the Control Display. You can have the system read aloud the possible voice commands, refer to page 23.

## Selecting country

1. Select "State / Province" or the displayed country and press the controller.  
A list of available countries appears on the display.



2. Select the country of destination and press the controller.

In order to be able to start the destination guidance, at least the city of the destination or its zip code must be entered.

## Entering destination

1. Select "Town / City" or the displayed town/city and press the controller.
2. Select the first letter and press the controller.  
A list of all towns/cities starting with this letter appears on the Control Display.
3. Enter additional letters if necessary.  
The list gradually grows smaller each time you enter a new letter.

To enter blanks:

Select `_` symbol and press the controller.

To delete the last letter entered:

Move the controller to the right to select `←|` and press the controller.

To delete all letters entered:

Move the controller to the right to select `←|` and press the controller, holding it down.



4. Select the town/city name from the list and press the controller.

## Entering town/city of destination via zip code

1. Select "Town / City" and press the controller.
2. Enter the zip code:  
Select the individual digits and press the controller.

To delete the numbers or letters entered:

Move the controller to the right to select `←|` and press the controller.

To delete all numbers or letters entered:

Move the controller to the right to select `←|` and press the controller, holding it down.



3. Select the zip code and press the controller. The corresponding town/city of destination is displayed.
4. Select the town/city of destination and press the controller.

### Entering street, house number and intersection

1. Select "Street" or the displayed street and press the controller.
2. For instructions on entry, refer to Entering town/city of destination.



After the street, you can also enter the intersection or the house number.

The intersection is entered in the same way as the street.

To enter the house number:

1. Select "House number" and press the controller.
2. Enter the house number:  
Select the individual digits and press the controller.

To delete entered digits or letters:

Move the controller to the right to select  and press the controller.

To delete all numbers or letters entered:  
Move the controller to the right to select  and press the controller, holding it down.

3. Select the house number and press the controller.

Only house numbers stored for the street on the navigation DVD can be entered.

### Starting destination guidance with manual destination entry

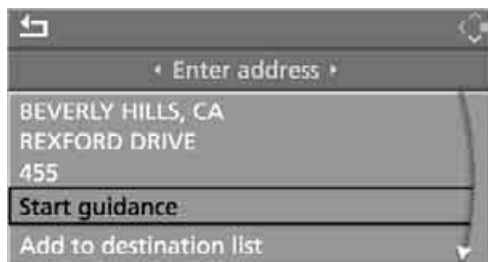

Select "Start guidance" and press the controller.

Destination guidance starts immediately.

If destination guidance is not to be started immediately:

Select "Add to destination list" and press the controller.

The destination is saved in the destination list, refer to page 119.

### Selecting destination using map

If you only know the street or position of the destination town/city, then you can enter the destination using a map. You can use the cursor to limit the destination in the map and then apply it into the destination guidance.

Control Center, for principle details, refer to page 16.

1. Select "Navigation" and press the controller.
2. Select "New destination" and press the controller.



3. Select "Input map" and press the controller.

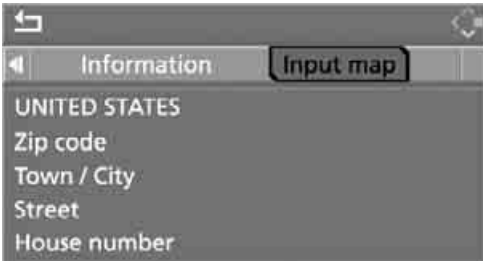

A section of a map is displayed on the Control Display:

- ▷ During destination guidance, around the current destination
- ▷ With the destination guidance deactivated, around the last destination entered



4. Turn the controller to change the scale. Move the controller in the desired direction to move the map. The controller can be moved to the left, right, forward, backward and also diagonally.
5. Press the controller to accept or save the destination at scales smaller than 1 mile/ 2 km. The selected town/city of destination and other menu items are displayed.
6. Select the desired menu item:
  - ▷ "Start route guidance" switches the destination guidance on.
  - ▷ "Show current position" places the current position back in the center of the map.

- ▷ "Show destination position" places the current destination in the center of the map.
- ▷ "Return to map" switches back to "Input map".
- ▷ ↩ Exit the menu.

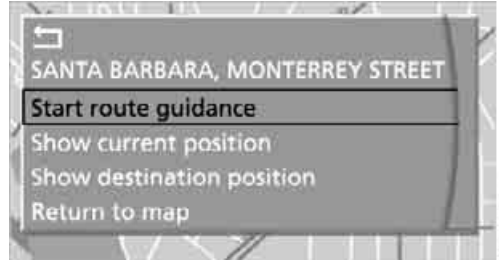

7. Press the controller.

## Selecting destination using information

You can obtain a display of selected destinations for towns/cities, call them and adopt them into the destination guidance if necessary, e.g. hotels, sights or hospitals.

Control Center, for principle details, refer to page 16.

1. Select "Navigation" and press the controller.
2. Select "New destination" and press the controller.
3. Select "Information" and press the controller.

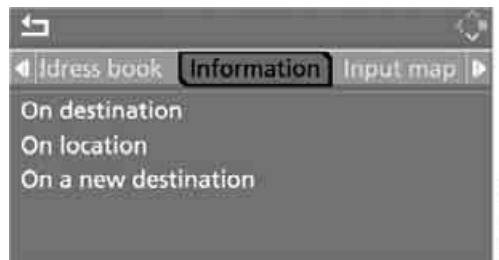

4. Selecting location:
  - ▷ "On destination"
  - ▷ "On location"
  - ▷ "On a new destination"

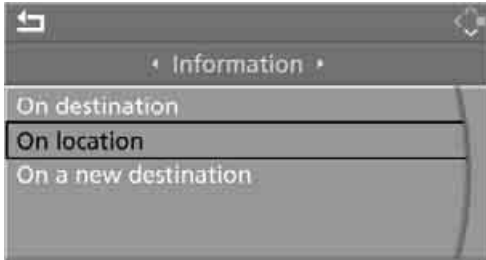

5. Press the controller.
6. Select the desired type of destination, such as "Hotels and restaurants".
7. Press the controller. Destinations are shown on the Control Display which are sorted by distance or alphabetically.
8. Select a destination and press the controller.
9. Select a menu item:
  - ▷ To apply the address in the destination list and start the destination guidance: Select "Select as destination" and press the controller.
  - ▷ To set up a telephone connection: Select "Call" and press the controller.

To exit from the menu:

- ↶ Select the arrow and press the controller.

## Destination list

The destination list shows the last 20 entered destinations as well as the current destination of the destination guidance. ➡ This symbol marks the current destination.

Control Center, for principle details, refer to page 16.

1. Select "Navigation" and press the controller.
2. Select a destination and press the controller.



3. The selected destination can be edited:
  - ▷ To start destination guidance: Select "Start guidance".  
 The destination guidance is started.
  - ▷ To store the entry: Select "Add to address book".
  - ▷ To display information on the destination: Select "Information on destination".
  - ▷ To delete the entry: Select "Delete entry".
  - ▷ To delete all entries: Select "Delete list". Destination guidance is switched off.
  - ▷ To change the entry: Select "Edit". For operation, refer to Entering destination, page 116

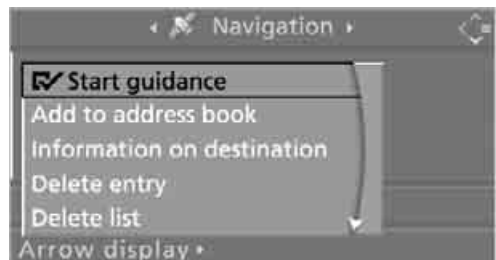

4. Press the controller.



## Address book

### Opening address book

Control Center, for principle details, refer to page 16.

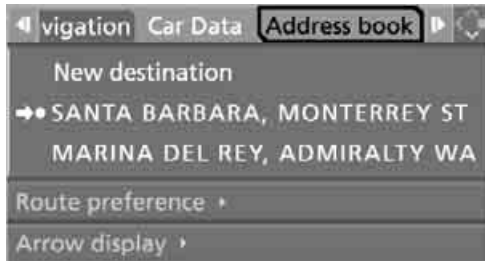

Select "Address book" and press the controller.

### Storing destinations in address book

You can save approx. 100 destinations in the address book.

Control Center, for principle details, refer to page 16.

1. Select "Address book" and press the controller.
2. Select "New address" and press the controller.

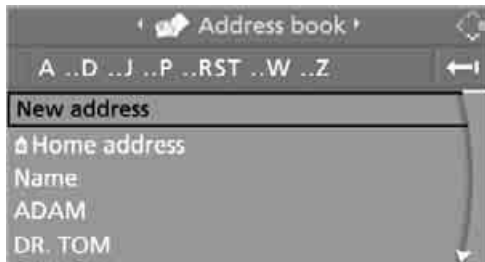

3. Select "Enter address" and press the controller.
4. Enter name and address.
5. Select "Store in address book" and press the controller.

The entry is stored in the address book.

You can also save a destination from the destination list in the address book, refer to page 119.

### Storing current position

The current position can be adopted into the address book:

Control Center, for principle details, refer to page 16.

1. Select "Address book" and press the controller.
2. Select "New address" and press the controller.

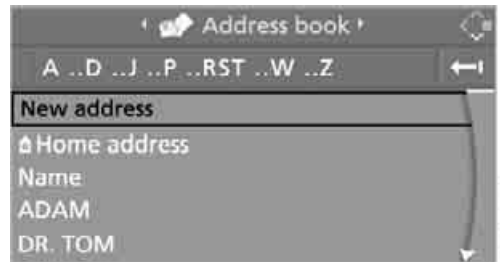

3. Select "Use current location as address" and press the controller.  
The name given can be changed. For operation, refer to Entering a destination manually, page 115
4. Select "Store in address book" and press the controller.

You can also enter your current position in the address book if you have left the sector covered by the navigation DVD. In this case, you must enter a name.

### Selecting destinations from address book

Control Center, for principle details, refer to page 16.

1. Select "Address book" and press the controller.  
The stored entries are displayed on the Control Display.



2. Select the entry and press the controller.

To start destination guidance:

Select "Start guidance" and press the controller.

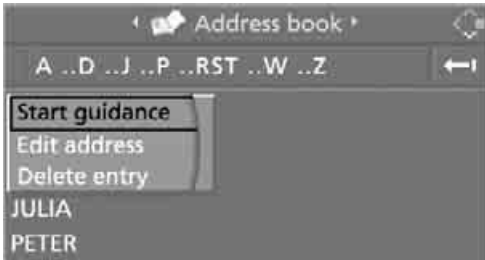

### Changing destinations from address book

Control Center, for principle details, refer to page 16.

1. Select "Address book" and press the controller.
2. Select the entry and press the controller.
3. Select "Edit address" and press the controller.

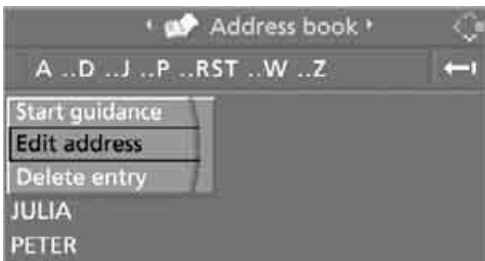

4. Change the entry.  
For operation, refer to Entering a destination manually, page 115

### Deleting individual destinations from address book

Control Center, for principle details, refer to page 16.

1. Select "Address book" and press the controller.
2. Select the entry and press the controller.
3. Select "Delete entry" and press the controller.

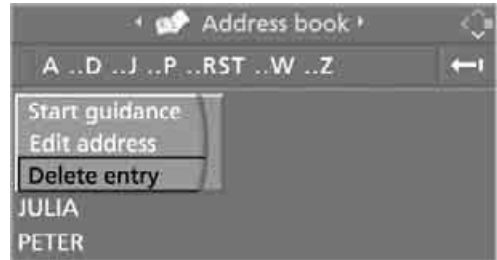

### Deleting all destinations from address book

Control Center, for principle details, refer to page 16.

1. Open start menu.
2. Press the controller to open the **i** menu.
3. Select "Vehicle settings" and press the controller.
4. Select "Delete data" and press the controller.

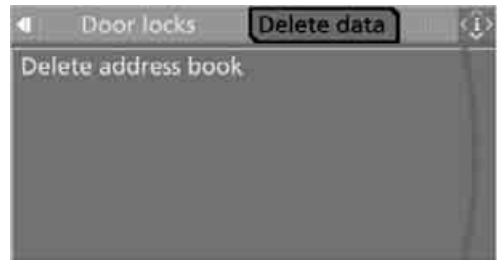

5. Select "Delete address book" and press the controller.
6. Select "Yes" and press the controller.

## Storing home address

You can store your current position or the current destination as a home address in the address book. This entry is in the second position in the address book.

Control Center, for principle details, refer to page 16.

1. Select "Address book" and press the controller.
2. Select "Home address" and press the controller.

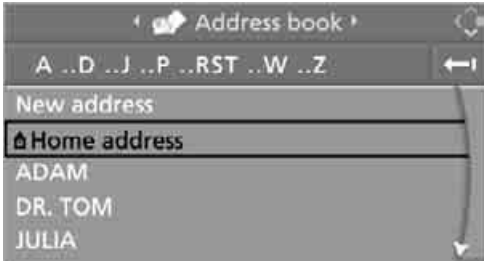

Select "Use current location as address" or during destination guidance "Save current destination".

3. Press the controller.

To select the home address as the destination: Select "Start guidance" and press the controller.

To change the entry: Select "Edit address" and press the controller. For operation, refer to Entering a destination manually, page 115

## Route selection

You can influence the calculated route by choosing certain route criteria.

### Changing route criteria

Control Center, for principle details, refer to page 16.

1. Select "Navigation" and press the controller.

2. Select "Route preference" and press the controller.

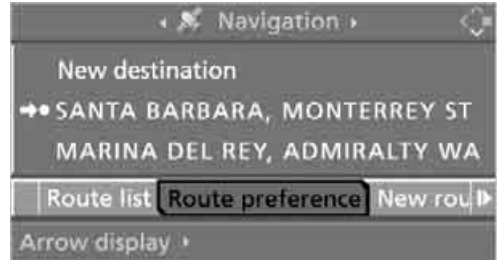

The various criteria are listed on the Control Display.

3. Select a route criterion for the route:
  - ▷ "With highways" Freeways and major traffic arteries are given priority.
  - ▷ "Avoid highways" Freeways are avoided where possible.
  - ▷ "Fast route" Shortest time using combination of smallest possible distance and sections where fast driving is possible.
  - ▷ "Short route" Shortest distance without consideration of the time.
4. Press the controller.

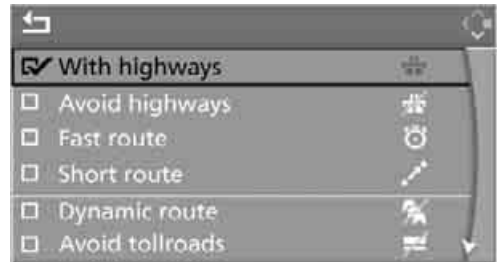

The route criterion is highlighted.

5. If necessary, select an additional route criterion and then press the controller:
  - ▷ "Dynamic route" Automatic changing of the route in case of traffic congestion. Depending on the road type and the type and length of the

traffic congestion, the route can also be calculated so that it is routed through the traffic congestion.

- ▷ "Avoid tollroads"  
Tollroads are avoided where possible.
- ▷ "Avoid ferries"  
Ferries are avoided where possible

To exit from the menu:

↩ Select the arrow and press the controller.

The route is planned according to fixed rules. Here the road type is taken into account, e.g. whether freeways or winding roads are concerned. The road types are stored on the navigation DVD. As a result, the routes recommended by the navigation system may not always be the same ones that you would choose based on personal experience.

You can change the choice of route as often as desired when entering the destination and whenever the destination guidance is active.

## Word matching principle

The system supports the word matching principle to make it easier for you to enter the names of streets or towns/cities. The system runs ongoing checks, comparing your destination entries with the data stored on the navigation DVD as the basis for instant response. The user benefits include:

- ▷ Names of specific locations can also vary from the official versions provided that the spelling of the entry corresponds to a standard form used in another country.

Example:

Instead of 'München', you can also enter the English spelling 'Munich' or the Italian spelling 'Monaco'.

- ▷ When you are entering the names of towns/cities and streets the system will complete them automatically as soon as enough letters are available to ensure unambiguous identification.

- ▷ The system only accepts name entries beginning with letters that are stored on the navigation DVD. The system will not accept nonexistent names and addresses.

# Destination guidance

## Starting destination guidance

Control Center, for principle details, refer to page 16.

1. Select "Navigation" and press the controller.
2. Select the destination from the destination list and press the controller or enter a new destination, refer to page 115.



3. Select "Start guidance" and press the controller.

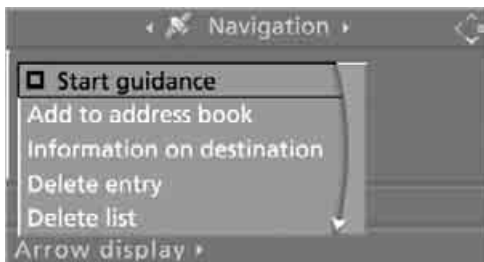

The destination guidance is started.

 This symbol marks the current destination.

After the route has been calculated, destination guidance is indicated by arrows or a route map on the Control Display.

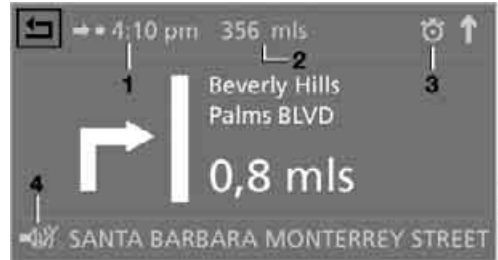

- 1 Estimated time of arrival
- 2 Distance to the destination on the calculated route
- 3 Route criterion
- 4 Switch voice instructions on/off

During destination guidance, you can operate other equipment using the Control Center at any time. You are notified well in advance of a necessary change of direction by spoken instructions and the display of the direction arrows.

To exit from the menu:

 Select the arrow and press the controller.

## Terminating/continuing destination guidance

Control Center, for principle details, refer to page 16.

➡ This symbol marks the current destination.

1. Select the current destination and press the controller.



2. Select "Start guidance" and press the controller.

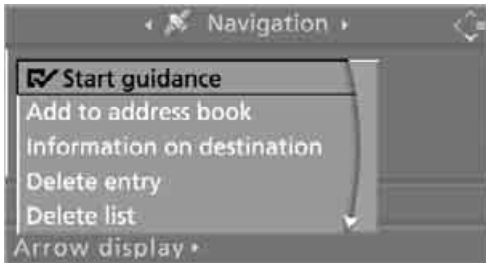

☐ The destination guidance is switched off.

When you park the vehicle before reaching the entered destination, upon restarting you will see the question "Continue guidance to destination?".

The destination guidance starts automatically after a short time.

To start destination guidance immediately: Select "Yes" and press the controller.

## Displaying current position

You can also display your current position with the destination guidance switched off.

Control Center, for principle details, refer to page 16.

1. Select "Navigation" and press the controller.
2. Select "Current position" and press the controller.

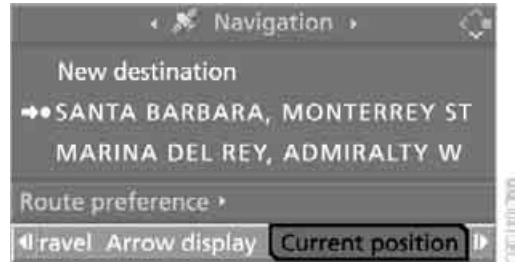

The current position of your BMW is displayed.

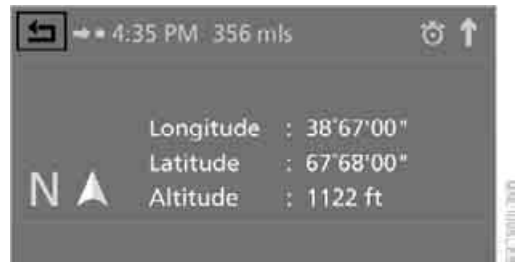

If the navigation system is unable to identify a town or city, your current map coordinates will appear.

To exit from the menu:

- ➡ Select the arrow and press the controller.

You can also have the current position displayed on a map, refer to page 127.

## Destination guidance through voice instructions

### Switching voice instructions on/off

Control Center, for principle details, refer to page 16.

1. Open start menu.
2. Press the controller to open the **i** menu.
3. Select "Display settings" and press the controller.
4. Select "Languages" and press the controller.

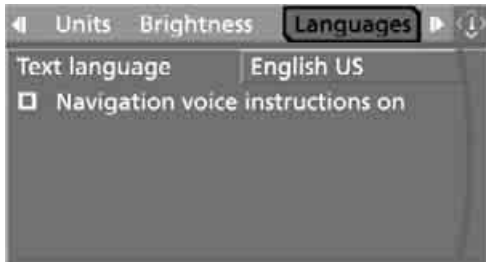

5. Select "Navigation voice instructions on" and press the controller.

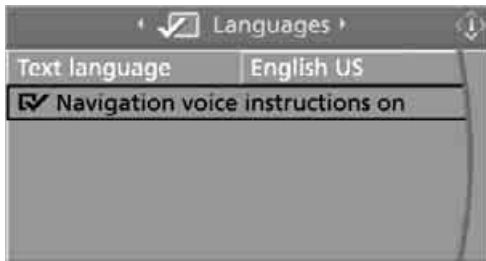

**✓** The voice instructions are switched on.

The setting is stored for the remote control currently in use.

### Repeating and canceling voice instructions

With the programmable buttons on the steering wheel, you can also make the following settings, refer to page 51:

- ▷ Repeat the voice instruction:  
Press the button.
- ▷ Switch voice instructions on/off:  
Maintain pressure on the button for several seconds.

### Adjusting volume

1. Repeat the last voice instruction, if required.
2. Turn the button during the voice instruction to select the desired volume.

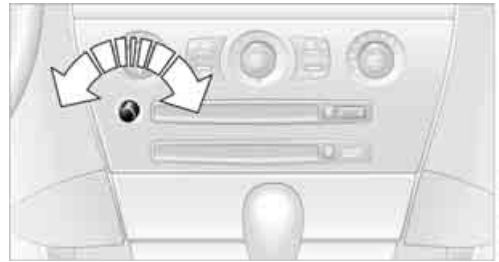

This volume is independent of the volume of the audio sources.

The setting is stored for the remote control currently in use.

## Displaying route

You have the option of displaying various views of the route during destination guidance.

### Displaying arrow view

1. Select "Navigation" and press the controller.
2. Select "Arrow display" and press the controller.



### Displaying route map

You can have your current position displayed on a map. After starting the destination guidance, the planned route is shown on the map.

1. Select "Navigation" and press the controller.
2. Select "Map, facing north" or "Map, direction of travel".

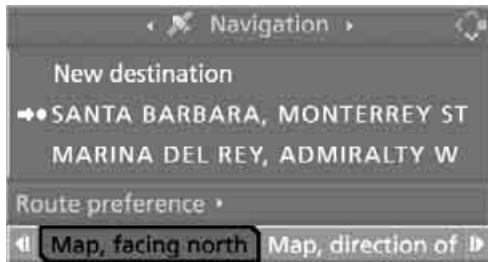

3. Press the controller.

At scales of less than 300 miles/500 km, you enjoy the option of deciding whether to orient the map to north or toward your current direction of travel. At scales of greater than 300 miles/500 km, the map always points toward north.

## Changing scale

Turn the controller to change the scale.

### Displaying towns/cities and streets of route

You can have the names of the streets and towns/cities on your route displayed whenever the destination guidance is active.

The distances remaining to be traveled on each individual road and directional arrows are also displayed.

Control Center, for principle details, refer to page 16.

1. Select "Navigation" and press the controller.
2. Select "Route list" and press the controller.

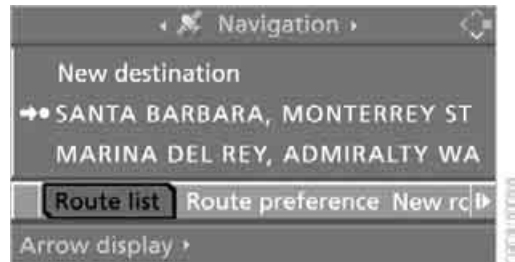

To exit from the menu:

- ← Select the arrow and press the controller.



## Bypassing route sections

During destination guidance, you can revise the navigation system's route recommendations to avoid particular stretches of road. Enter the number of miles/kilometers that you want to travel before returning to the original route.

Control Center, for principle details, refer to page 16.

1. Select "New route" and press the controller.

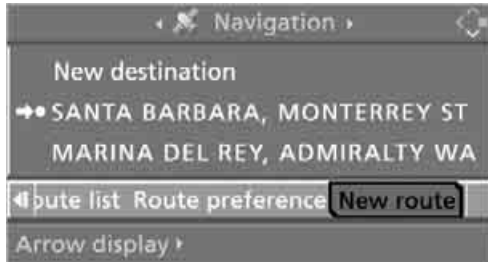

2. Turn the controller to enter the desired number of miles/kilometers and press the controller.

The route is recalculated.

To exit from the menu without changing the route:

- ↩ Select the arrow and press the controller.

# What to do if ...

## What to do if ...

- ▶ a navigation DVD is inserted, but the request to insert the DVD is displayed on the Control Display?  
The navigation DVD may not be the right DVD for the navigation system. The DVD is labeled accordingly.
  - ▶ you request the current position of your vehicle, but do not receive a precise display?  
The system is unable to receive enough GPS signals at your current position owing to obstructions, your current position is not yet available on your navigation DVD, or the system is in the process of calculating your current position. As a rule, reception is guaranteed under a clear sky.
  - ▶ the destination guidance does not accept a destination?  
The data of the destination is not stored on the navigation DVD that is loaded. Select a destination that is as close as possible to the original.
  - ▶ the destination guidance does not accept an address without the street name?  
On the navigation DVD, no downtown area can be determined for the city or town entered. Enter any street, or a destination such as the railway station etc., then start the destination guidance.
- ▶ you want to enter a destination for the destination guidance, but it is not possible to select the letters for your desired entry?  
The data of the destination is not stored on the navigation DVD that is loaded. In this case, the system will not offer you any letters to choose from. Select a destination that is as close as possible to the original.
  - ▶ the system stops furnishing directions on which way to turn as you approach intersections?  
You are driving in an area that has not yet been completely recorded on the navigation DVD. Instead of an arrow indicating a turn, you will see an arrow which indicates the general direction of your planned route. Or you have left the recommended route and the system requires a few seconds to calculate a new recommended route.
  - ▶ the navigation system does not react to entries?  
If the battery was disconnected, it then takes up to 10 minutes before the system is once again operational.





## Entertainment

Operation of the radio and CD as well as their tone settings are described in this chapter.

## On/off and tone

The following audio sources have shared controls and setting options:

- ▷ Radio Business
- ▷ CD player
- ▷ CD changer\*

### Controls

The audio sources can be operated using:

- ▷ Buttons near CD player
- ▷ Control Center
- ▷ Buttons on the steering wheel, refer to page 11

#### Buttons near CD player

The layout of the buttons can vary depending on your vehicle's equipment.

Equipment with single drive:

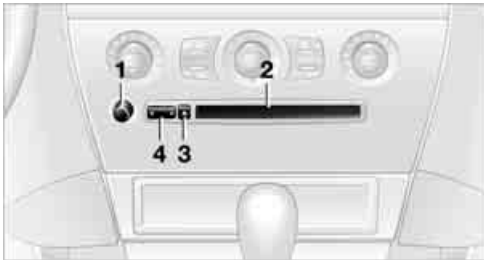

Equipment with two drives:

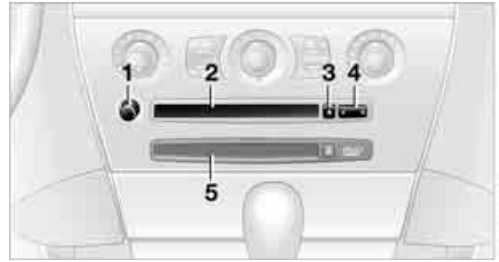

- 1 Sound output for Entertainment on/off, volume
  - ▷ Press: to switch on/off. When you switch on, the last set radio station or CD track is played.
  - ▷ Turn: to adjust volume.
- 2 Drive for audio CDs
- 3 Eject CD
- 4 Station scan/track scan
  - ▷ Change radio station.
  - ▷ Select track for CD player and CD changer.
- 5 Drive for navigation DVDs

#### Operation using Control Center

Control Center, for principle details, refer to page 16.

1. Press **MENU** button. This opens the start menu.



2. Move the controller backward to open "Entertainment".



You have the following choices:

- ▷ "FM" or "AM": select radio reception.
- ▷ "WB": call up Weather Band station.
- ▷ "SAT": select satellite radio.
- ▷ "CD": select CD player or CD changer.
- ▷ "Set": depending on each audio source, other settings can be made, e.g. on the radio: updating stations with best reception, storing stations, tone control, playing stations.

## Switching on/off

To switch the sound output for entertainment on/off:

Press button **1** next to the CD player.

■ This symbol on the Control Display indicates that sound output is switched off.

## Adjusting volume

Turn button **1** next to the CD player until the desired volume is set.

The volume can also be set on the steering wheel.

The setting is stored for the remote control currently in use.

## Tone control

You can alter various tone settings, e.g. treble and bass, or the speed-dependent volume increase.

The settings are stored for the remote control currently in use.

### Changing tone settings

Control Center, for principle details, refer to page [16](#).

1. Press **MENU** button.  
This opens the start menu.



2. Press controller to open the **i** menu.
3. Select "Entertainment settings" and press the controller.



4. Select "Audio" and press the controller.



The tone settings can also be selected if you have opened "Entertainment" in the start menu: Select "Set" or "Tone" and press the controller.

## Treble and bass

1. Select "Treble / Bass" and press the controller.



2. Move the controller to the left or right to select "Treble" or "Bass".



3. Turn the controller until the desired setting is selected.

## Balance and fader

You can set the right/left and front/rear volume balance in the same manner as "Treble / Bass".

## Speed-dependent volume increase

The speed-dependent volume control automatically increases the volume with increasing speed. You can set various stages for the increase in volume.

1. Select "Speed volume" and press the controller.



2. Turn the controller. The adjustment is applied; the field can be changed.



## Professional LOGIC7 HiFi System\*

You can select a spatial sound effect that improves the spatial acoustics in all frequency ranges.

1. Select "LOGIC7" and press the controller.





2. Select "Concert hall" or "Theater".

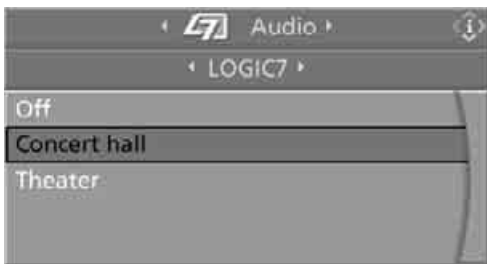

3. Press the controller.
 

LOGIC7 spatial sound is switched on.

To switch off spatial sound:  
Select "Off" and press the controller.

LOGIC7 and the LOGIC7 logo are registered trade marks of Lexicon, Inc., a company of the Harman International Group.

### Equalizer\*

You can set individual sound frequency ranges:

1. Select "Equalizer" and press the controller.



2. Move the controller to the left or right to select the desired frequency range.



3. Turn the controller until the desired setting is selected.

### Resetting tone settings

You can reset all tone settings except "Speed volume" to the standard default settings.

1. Open start menu.
2. Press controller to open the  menu.
3. Select "Entertainment settings" and press the controller.
4. Select "Audio" and press the controller.
5. Select "Reset" and press the controller.





# Radio

Your radio provides reception of the FM and AM wavebands.

## Listening to the radio

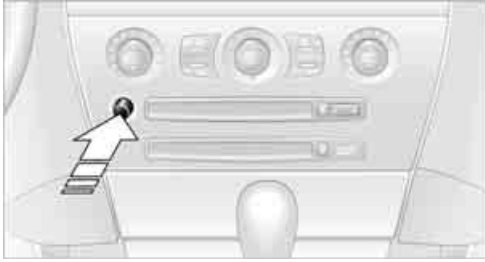

Press the button if the sound output is switched off.

Control Center, for principle details, refer to page 16.

1. Press **MENU** button.  
This opens the start menu.



2. Move the controller backward to open "Entertainment".
3. Select "FM" or "AM".



4. Press the controller.

Stations are shown on the Control Display on the basis of various selection criteria, e.g. "Presets".

If no station is displayed for "Autostore" or the displayed station cannot be received, update the stations with the strongest reception, refer to page 138.

## Changing station



turn the controller.

In addition to the stations currently displayed, you can have stations with another selection criterion displayed.

You can choose from the following selection criteria:

- ▷ "Autostore":  
The stations with the strongest signal, refer to page 138.
- ▷ "Presets":  
Stations you have stored, refer to page 138.

To change between these different selection criteria of stations:

1. Move the controller forward to change fields.
2. Select a selection criterion.



3. Press the controller.

The stations can also be changed on the steering wheel.

Buttons next to CD player:

 Press the button for the corresponding direction.

The system switches to the next displayed station.

### Playing stations, scan

The system automatically plays a brief sample from each of the stations on the current waveband.

In "Manual", you can set stations that are received in addition to those displayed.

Buttons next to CD player:

 To start scan, press and hold the button for the desired direction.

To stop scan, press the button.

Control Center, for principle details, refer to page 16.

1. Select "FM" or "AM".
2. Press the controller.
3. Press the controller again.  
Other menu items are displayed.

4. Select "Scan" and press the controller.



Scan starts.

To stop the scan:

1. Press the controller.
2. Select "Scan" and press the controller.

This cancels the scan search, and the radio remains on the current station.

### Selecting frequency manually

Control Center, for principle details, refer to page 16.

1. Select "FM" or "AM".
2. Press the controller.
3. Move the controller forward to change fields.
4. Select "Manual" and press the controller.



5. Turn the controller to set a certain frequency.

## Updating stations with best reception

If you are on a longer journey and leave the transmission range of the stations originally set, you can update the list of stations with the best reception.

Control Center, for principle details, refer to page 16.

1. Select "FM" or "AM".
2. Press the controller.
3. Move the controller forward to change fields.
4. Select "Autostore" and press the controller.



5. Press the controller again. Other menu items are displayed.
6. Select "Autostore" and press the controller.



The display of the stations with the strongest reception is updated. The stations are displayed based on their frequencies.

## Storing stations

Control Center, for principle details, refer to page 16.

1. Select "FM" or "AM".
2. Select the desired station. "Set" has been selected.



3. Press the controller. Other menu items are displayed.
4. Select "Store" and press the controller.



"Presets" is displayed.

5. Turn the controller until the desired memory position is selected. The number of the memory position appears beside the name or frequency of the station.
6. Press the controller. The station is stored.



The stations of the last selection criterion are displayed again after a short time.

The stations are stored for the remote control currently in use.

## Changing a memory location

Control Center, for principle details, refer to page 16.

1. Select "Presets" and press the controller.
2. Select the desired station.
3. Press the controller.  
Other menu items are displayed.
4. Select "Store" and press the controller.



5. Turn the controller until the desired memory position is selected.  
The number of the memory position appears beside the name or frequency of the station.
6. Press the controller.  
The station is stored.

## RDS Radio Data System

RDS transmits additional information in the FM frequency range. RDS stations have the following properties:

- ▷ In the case of broadcasting networks that transmit over a number of frequencies, there is an automatic switch to the frequency with the best reception quality.
- ▷ If the reception conditions are good, the station names are shown on the Control Display. If the reception is weak or disrupted, it can take some time before the station names appear.

## Weather Band\*

Weather Radio is a service of the National Oceanic and Atmospheric Administration – NOAA – of the U.S. Department of Commerce. Weather messages are repeated every four to six minutes and are routinely revised every one to three hours, or more frequently if needed. Most of the stations operate 24 hours daily. During severe weather, National Weather Service forecasters can interrupt the routine weather broadcasts and substitute special warning messages. If you have a question concerning NOAA Weather Radio, please contact your nearest National Weather Service Office, or write to National Weather Service – Attn: W/OM11 –, National Oceanic and Atmospheric Administration, 1325 East-West Highway, Silver Spring, MD. 20910.

## Selecting Weather Band

Control Center, for principle details, refer to page 16.

1. Select "WB" and press the controller.
2. Select the Weather Band station and press the controller.

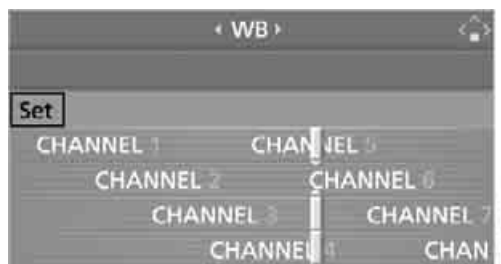

The Weather Band station may be unavailable in some regions.

## Satellite radio\*

You can receive up to 100 different channels with high sound quality.

The channels are offered to you in predefined packages. To receive the channels of your choice, you must have this package enabled.

 You may experience signal drops and muting events related to this new technology. ◀

### Enabling or disabling channels

Control Center, for principle details, refer to page 16.

1. Press **MENU** button.  
This opens the start menu.



2. Move the controller backward to open "Entertainment".
3. Select "SAT".



4. Press the controller.

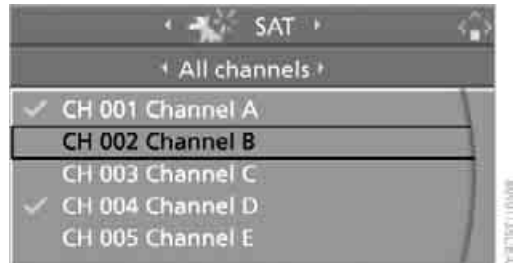

The channels are displayed.

- ✓ These channels are enabled.

### Enabling

1. Select a channel that has not yet been enabled and press the controller.  
A telephone number and the electronic serial number, ESN, are displayed.

 The electronic serial number is required to enable or disable. ◀

2. To have the channels enabled:  
Dial phone number.

### Disabling

1. Select an enabled channel and press the controller.

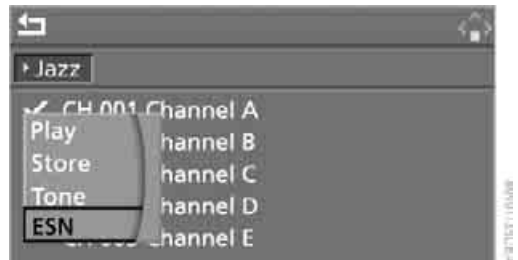

2. Select "ESN" and press the controller.  
The electronic serial number, ESN, is displayed.

 The electronic serial number is required to disable. ◀

3. To have the channels disabled:  
Dial phone number.

## Selecting and storing channel

1. Select "SAT" and press the controller.



Channels are shown on the Control Display sorted on the basis of selection criteria

2. Select a menu item:
  - ▷ "Presets":  
Up to twelve channels you have stored.
  - ▷ "All channels":  
All channels are displayed.
  - ▷ "Categories":  
All channels sorted by category, e.g. news, jazz.



3. Press the controller.
4. If "Categories" has been selected:  
Select the desired category and press the controller.

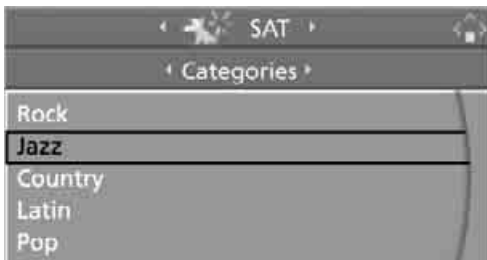

The channels of this category are displayed.

5. ✓ Select a channel marked with this symbol.

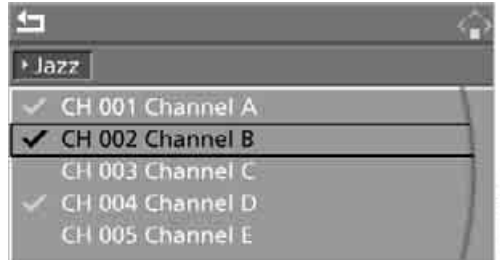

6. Press the controller.  
Other menu items are displayed.
7. Select "Play" and press the controller.

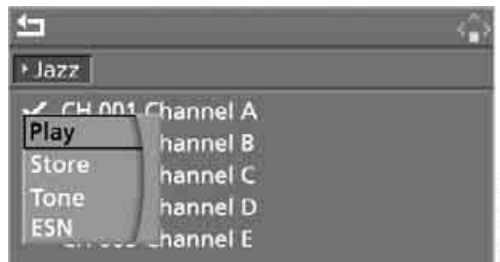

## Additional information

The name of the channel and additional information on the current track are displayed, e.g. the name of the artist.

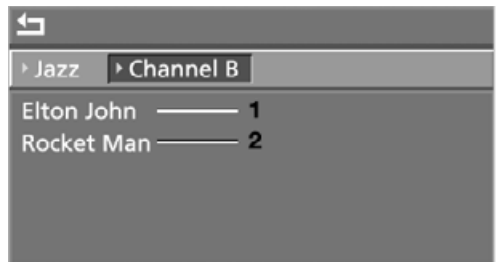

- 1 Artist
- 2 Track

## Storing channel

1. Select desired channel.
2. Press the controller.  
Other menu items are displayed.
3. Select "Store" and press the controller.

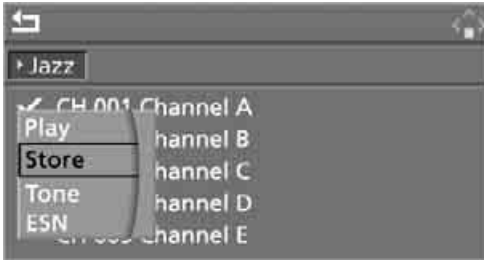

"Presets" is displayed.

4. Turn the controller to select a memory location and press the controller.

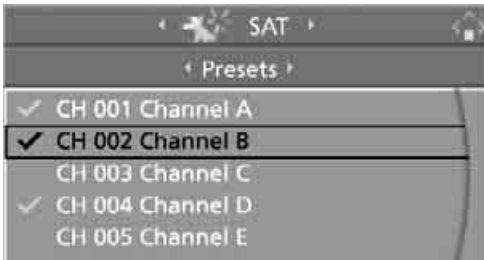

The channel is stored. The stations of the last selection criterion are displayed again after a short time.

## Changing channel with buttons next to CD player

- ◀ ▶ Press the button for the corresponding direction.  
The system switches to the next enabled channel.

## Notes

When there is a signal blockage or the transmission is suspended momentarily for more than 4 seconds, a message appears on the Control Display.

▶ Service may be interrupted or unavailable for specific reasons such as environmental or topographic conditions and others that Satellite Radio cannot directly control. Signal may not be available under tunnels, in parking garages, next to tall buildings, nearby trees with dense foliage, nearby mountains or other possible strong sources of radio interference.

Service should resume normally after the source of signal unavailability has been cleared. ◀

# CD player and CD changer\*

## Listening to CDs

### CD player: starting CD



Equipment with two drives:  
The upper drive is for audio CDs.

Insert the CD with the labeled side facing upward.

Playback starts automatically if the sound output is on.

To start playback when there is already a CD in the drive:

Control Center, for principle details, refer to page 16.

1. Press **MENU** button.  
This opens the start menu.



2. Move the controller backward to open "Entertainment".

3. Select "CD" and press the controller.



4. On vehicles with a CD changer, select "CD" and press the controller to start the CD player.

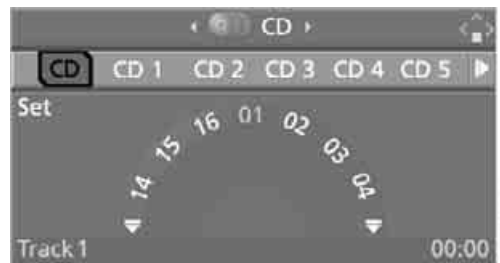

Playback starts if the sound output is switched on.

Press the  button next to the CD player in order to eject the CD.  
The CD emerges slightly from the drive.



## CD changer: starting CD

1. Fill the CD magazine and insert, refer to page 145.  
Control Center, for principle details, refer to page 16.
2. Press **MENU** button.  
This opens the start menu.



3. Move the controller backward to open "Entertainment".
4. Select "CD" and press the controller.
5. Select the desired CD and press the controller.

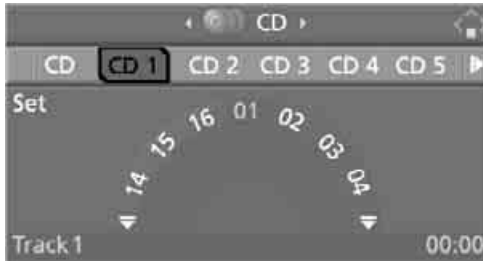

At the end of the last track, the next CD will be selected.

If new CDs have been placed in the CD magazine, playback starts with the lowest CD, e.g. CD 1, track 1.

The CD magazine's load status is indicated on the Control Display.

## Selecting a track

Buttons next to CD player:

Press the  button for the corresponding direction repeatedly, continuing until you reach the desired track on the current CD.

The CD will start play at the start of the track. The track is displayed on the Control Display.

The track can also be changed on the steering wheel.

Control Center, for principle details, refer to page 16.

Select a track by turning the controller.



## Repeating a track

Control Center, for principle details, refer to page 16.

1. Select "Set" and press the controller.  
Other menu items are displayed.



2. Select "Repeat" and press the controller.

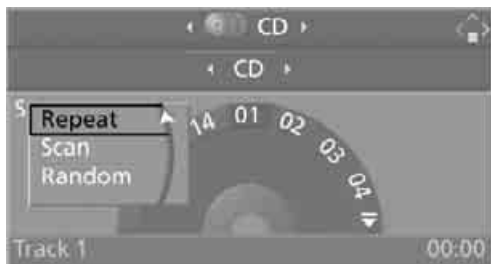

The current music track on the CD is repeated.

To stop repetition:

1. Press the controller
2. Select "Repeat" and press the controller.

## Track sample scan

The system automatically plays a brief sample from each of the tracks on the current CD.

Control Center, for principle details, refer to page 16.

1. Select "Set" and press the controller. Other menu items are displayed.
2. Select "Scan" and press the controller.

To stop the scan:

1. Press the controller again.
2. Select "Scan" and press the controller.

This cancels the scan, and the selected track remains.

## Random play sequence

In this mode, the music tracks on the current CD are played once in a random sequence.

Control Center, for principle details, refer to page 16.

1. Select "Set" and press the controller. Other menu items are displayed.
2. Select "Random" and press the controller.

To stop the random mode:

1. Press the controller
2. Select "Random" and press the controller.

## Fast forward/reverse

Buttons next to CD player:

Press and hold the  button for the corresponding direction.

## CD magazine

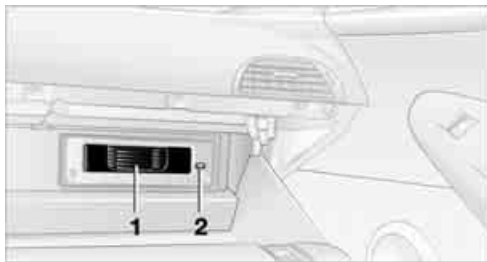

The BMW CD changer for six CDs is installed in the glove compartment.

## Removing CD magazine

To insert or remove CDs from the CD magazine 1, you must first remove it from the CD changer:

1. Press button 2. The CD magazine 1 is ejected.
2. Remove CD magazine.

## Inserting/removing CDs from CD magazine



When inserting or removing CDs, remember to hold them only by their edges, taking care to avoid touching the reflective CD memory surface.

To insert:

Insert the CD in a CD slot with the labeled side facing upward.

To remove:

Pull out the desired drawer, refer to arrow, and remove the corresponding CD.

## Inserting CD magazine

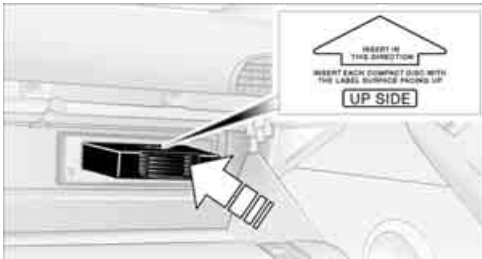

Push in the CD magazine as far as possible in the direction of the arrow.

The CD changer automatically reads in the inserted CDs and is then ready for operation.

## Notes

Data from CDs, CD-Rs and CD-RWs can be played.

## Safety notes

 The BMW CD drives are Class 1 laser products. Do not operate if the cover is damaged, otherwise severe eye damage can result.

Do not use self-recorded CDs with labels applied as these can become detached during playback due to the development of heat and cause irreparable damage to the device.

Only use round CDs with a standard diameter of 4.7 in/12 cm and do not play CDs with an adapter, e.g. Single-CDs, otherwise the CDs or the adapter can jam and may no longer be ejected.

Do not use a combined CD/DVD, e.g. DVDPlus, as otherwise the CD/DVD can jam and will no longer eject. ◀

## Malfunctions

To prevent illegal CD copying, manufacturers often use copy protection. This can mean that some CDs cannot be played or can only be played to a limited extent. In this case, please contact the CD dealer or manufacturer.

You may experience playback problems, such as skips, when using CD-Rs/CD-RWs that you have copied at home.

If the CD that you have loaded in the drive does not play, check to ensure that the CD has been inserted correctly and inspect it for signs of defects.

High levels of humidity can lead to condensation on the laser's scan lens and temporarily prevent it from reading the CD.

Always hold CDs by the edges; do not touch the reflecting CD memory surface.

## Care instructions

You can find everything you need to know on this topic by consulting the Caring for your vehicle brochure.





## Communications

This chapter summarizes how to operate your BMW portable phone via the Control Center or voice control and how to use BMW Assist or TeleService.

# Telephoning

## Safety notes

### For your own safety

Your car phone makes life more convenient in many ways, and can even save lives in an emergency. While you should consult your portable phone's separate Owner's Manual for a detailed description of safety precautions and information, we request that you direct your particular attention to the following:

### Adjustments

 To avoid posing a danger to yourself and other road users, never adjust the system settings unless your vehicle is stationary. ◀

### Using the phone in your vehicle

 Using a portable phone while driving is already illegal in many states and cities. Always use your hands-free system, or stop your vehicle in an area where you will not pose a safety hazard to other road users. ◀

### Vehicles and portable phones

 Do not use your phone within a garage, or near an open hood. The air in these areas could contain fuel vapors, and the portable phone might generate sparks that could result in burns.

This same precaution applies to open luggage compartment lids on vehicles equipped for operation using natural gas or hydrogen, and to all vehicles with luggage compartment-mounted batteries. ◀

### Antenna

 When using the phone, ensure that all persons in the area are at least 20 in/ 50 cm from the antenna. Never use your portable phone if the antenna is damaged. Contact between your skin and a damaged antenna can result in minor burns.

If the antenna is damaged, have it replaced immediately. ◀

### Special environmental conditions

 Always switch off your portable phone in areas where blasting work is being conducted with explosives. The phone signals could potentially act as a high-frequency transmitter and set off explosions.

Always switch off your portable phone in areas where an increased explosion danger is present. This category includes gas stations along with fuel and chemical storage depots, etc., and all areas in which the air can contain fuel, chemicals or metal particles. Under these conditions, your portable phone could conceivably generate sparks that could lead to a fire or explosion. Always observe all legal regulations governing the use of portable phones in the vicinity of gas stations, chemical factories and other areas where an explosion potential exists. Never use your portable phone in aircraft; do not use this portable phone in hospitals, care centers or at other locations where medical equipment may be in operation, such as accident sites, etc.

Your wireless service provider can furnish you with more detailed information on legal regulations governing the use of your phone. ◀

### Medical equipment

 Portable phones can generate interference capable of preventing hearing aids and cardiac pacemakers from operating correctly. If you or any occupant of the vehicle use such equipment, consult a physician or the manufacturer of the equipment to determine whether it is adequately shielded against high-frequency energy. ◀

### Batteries

 Never attempt to dismantle your portable phone or its battery. Use only approved battery types – the wrong battery can destroy

your portable phone.

To avoid possible short circuits, after removing a battery you should never allow it to come into contact with metallic surfaces of any kind. ◀

### Disposing of used batteries



Return used batteries to a recycling collection point or to your BMW center. ◀

## Care instructions

You can find what you need to know about caring for your portable phone in the Caring for your vehicle brochure and in the separate portable phone Owner's Manual.

## Operating options

You can operate the portable phone\* with:

- ▷ The steering wheel, refer to page 11
- ▷ The Control Center, refer to page 152
- ▷ Voice commands, refer to page 156

Information on operating the portable phone is contained in the separate Owner's Manual on the Full Preparation Package Cellphone.

### Telephoning with car phone: BMW Assist calls

You can use the car phone via the hands-free system for BMW Assist calls.

When the status information "Car Phone" is displayed in "Communication", only BMW Assist calls are possible.

## Hands-free system

The microphone is located:

- ▷ In the Coupe near the interior rearview mirror, refer to page 14
- ▷ In the Convertible on the steering column

The hands-free system is activated whenever you establish or receive a call using:

- ▷ The button on the steering wheel
- ▷ The Control Center
- ▷ Voice commands

### Volume adjustment



Turn the button during a call to select the desired volume.

This volume for the hands-free system is maintained, even if the other audio sources are set to minimum volume.

The setting is stored for the remote control currently in use.

## Operation using Control Center

The following functions can be used via the Control Center as soon as the portable phone is laid in the cradle or is connected to the vehicle via Bluetooth:

- ▷ Dialing phone numbers
- ▷ Phone book
- ▷ Top 8
- ▷ Redialing
- ▷ Displaying accepted calls
- ▷ Displaying missed calls
- ▷ Text messages/SMS



Control Center, for principle details, refer to page 16.

1. Press the **MENU** button.  
This opens the start menu.



2. Move the controller forward to open "Communication".

### Receiving calls

If you have the phone number of the caller stored in the phone book and the phone number is transmitted, the entry is displayed.

### Accepting a call

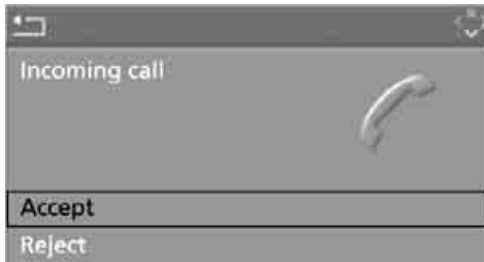

Select "Accept" and press the controller.

### Rejecting a call

Select "Reject" and press the controller. The caller is diverted to your mailbox if it has been activated.

## Calling

### Dialing phone numbers

1. Select "Phone" and press the controller.



2. Select "Dial" and press the controller.
3. To enter the phone number: select digits individually and press the controller. Always enter the complete phone number consisting of area code, and phone number. To delete an incorrect digit: Move the controller to the right to select  and press the controller.
4. Select "Dial number" and press the controller.



### Ending a call

1. If necessary, select the telephone number.



2. Press the controller.  
Other menu items are displayed.
3. Select "End call" and press the controller.



## Phone book

After the portable phone is placed in the cradle or connected to the vehicle via Bluetooth, the phone book is transferred from the portable phone to the vehicle. Loading the phone book can take several minutes.

## Dialing from phone book

1. Select "Phone" and press the controller.



2. Select "A - Z" and press the controller.  
An alphabetical listing of all the entries in the phone book appears on the Control Display.

To run a targeted search for an entry, select the first letter of the entry and press the controller.

The first entry that starts with this letter is displayed.

3. Select the desired entry.



4. Press the controller.  
Other menu items are displayed.
5. Select "Call" and press the controller.  
The system dials the number.

If different phone numbers are stored in the portable phone under one name, e.g. office and home, the name is shown once for each phone number.

## Adding digits to phone numbers

You can add other digits to a phone number stored in the phone book, e.g. to call a specific extension:

1. Select "Phone" and press the controller.
2. Select "A - Z" and press the controller.
3. Select the desired entry.
4. Press the controller.  
Other menu items are displayed.
5. Select "Add digits" and press the controller.
6. To add to the phone number: select digits individually and press the controller.
7. Select "Dial number" and press the controller.

## Lists

Your phone stores phone numbers you have dialed and calls you have missed. If the caller is entered in the phone book, the name of the caller is displayed instead of the phone number. You can select the desired subscriber from the list and establish the connection.

Four lists are available:

- ▷ "Top 8"  
The eight numbers called most frequently via the list "A - Z" are automatically stored in the Top 8 list. The number called most often appears at the top of the list.
- ▷ Redial  
The last eight phone numbers you have dialed are automatically stored. The last number dialed is at the top of the list.
- ▷ "Received calls"  
The phone numbers of the last eight calls accepted while the portable phone was in the cradle or connected to the vehicle via Bluetooth are stored. This requires the phone number of the caller to have been sent.
- ▷ "Missed calls"  
The phone numbers of the last eight calls not accepted while the portable phone was in the cradle or connected to the vehicle via Bluetooth are stored. This requires the phone number of the caller to have been sent.

## Dialing from a list

To select an entry and establish a connection:

1. Select "Phone" and press the controller.
2. Select the list
  - ▷ "Top 8"
  - ▷ "Redial"
  - ▷ "Received calls"
  - ▷ "Missed calls"



3. Press the controller.

4. Select the desired entry.



5. Press the controller.  
Other menu items are displayed.
6. Select "Call" and press the controller.  
The system dials the number.

## Deleting individual entries

1. Select the desired entry from the list.
2. Press the controller.  
Other menu items are displayed.
3. Select "Delete" and press the controller.  
The entry is deleted.



## Deleting entire list

1. Select an entry from the list.
2. Press the controller.  
Other menu items are displayed.

3. Select "Delete all numbers" and press the controller.  
The list is deleted.



### Touch tone dialing

Touch tone numbers are required for access to network services or to control devices, e.g. remote access to an answering machine.

This function can only be used during a call.

1. Establish a connection.



2. Press the controller.  
Other menu items are displayed.
3. Select "Keypad" and press the controller.
4. Select the desired digits and press the controller.  
Each digit is sent immediately.



### Text messages/SMS\*

✉ This symbol on the Control Display indicates that you have received a new text message. The symbol is no longer displayed after there are no unread text messages.

The number of text messages that can be stored depends on the memory capacity of your portable phone.

### Displaying text messages/SMS

1. Select "SMS" and press the controller.



The list of received text messages is displayed on the Control Display.

✉ The symbol indicates unread text messages.

2. Select the desired text message and press the controller.  
The text message is displayed.

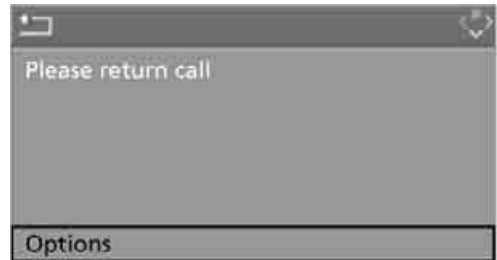

To close the text message:

Move the controller forward to select  and press the controller.

### Calling sender

1. Select the desired text message and press the controller.  
The text message is displayed.

2. Select "Options" and press the controller.
3. Select "Call sender" and press the controller.  
The selected sender is called.

### Deleting text messages/SMS

1. Select the desired text message and press the controller.  
The text message is displayed.
2. Select "Options" and press the controller.
3. Select "Delete" and press the controller.  
The text message of the portable phone is deleted.

## Operation by voice commands\*

### The concept

You can operate your portable phone without having to remove your hands from the steering wheel. The system operates on the basis of voice commands that you will learn easily after using them a few times. In addition, you are also supported by instructions or questions.

### Symbols used

-  ›...‹ Identifies voice commands.
- ››...‹‹ Identifies instructions generated by the system.

### An example: dialing phone numbers



Start the dialog:

Press the  button on the steering wheel.

Voice command	Response
›Dial number‹	››Please say the number‹‹
e.g. ›123 456 7890‹	››123 456 7890. Continue?‹‹
›Dial‹	››Dialing number‹‹

### Voice commands

In ignition key position 2:

1. Press the  button on the steering wheel.  
An acoustic signal indicates operating readiness.
2. Read voice commands aloud.  
To have the system list the voice commands possible in each case:  
 ›Options‹.

### Canceling operation by voice commands

Press the  button on the steering wheel or

 ›Cancel‹.

In dialogs where text is spoken, not a command, e.g. a name, canceling is only possible using the  button. The dialog is automatically interrupted when an incoming call is received.

### Voice commands

In addition to the commands described in this Owner's Manual, alternative commands are often possible for the same functions, e.g.:

 ›Dial name‹ or ›Name‹.

The system recognizes digits from zero to nine.

You can say each digit individually or group them into a sequence of three to five digits to speed up the process.

## Volume adjustment

You can adjust the volume for the instructions from the system:



Turn the button during an instruction to select the desired volume.

This volume for the instructions is maintained, even if the other audio sources are set to minimum volume.

The setting is stored for the remote control currently in use.

## Calling

### Dialing phone numbers

1. ›Dial number‹.  
The dialog for establishing a telephone connection is opened.
2. Say the phone number.  
For telephone calls abroad, say ›Plus‹ and then the country code.
3. ›Dial‹.  
The connection to the desired subscriber is established.

### Correcting phone number

After the last spoken sequence of digits has been repeated by the system, you can delete this sequence of digits.

- ›Correct number‹.  
The digits are deleted.

The command ›Correct number‹ can be repeated as often as you like.

## Deleting input

›Delete‹ is used to delete all the digits entered so far.

## Voice phone book

Operating by voice commands requires a personal voice phone book. Depending on the equipment, the entries are either transferred from the memory of your portable phone or they must be entered independently. In the latter case, it is not possible to use voice command either to call phone numbers stored in the portable phone or to store new numbers.

### Storing an entry\*

An entry always consists of a name and phone number.

1. ›Save name‹.  
The dialog for storing a name is opened.
2. Speak name and repeat entry upon request.  
The spoken length of the names in the phone book must not exceed approx. 2 seconds.
3. Say the phone number when prompted.
4. To save the phone number:  
›Save‹.

### Selecting an entry

The connection to the phone number of the selected entry is established.

1. ›Dial name‹.  
The dialog for selecting an entry is opened.
2. Say the name when prompted.
3. Confirm the prompt with ›Yes‹.

## Having entries read aloud\* and selecting

You can have all the entries of your voice phone book read aloud in the order of input and select a certain entry to establish a connection:

1. ›Read phone book‹.  
The dialog for reading the phone book aloud is opened.
2. ›Dial number‹ when the desired entry is read out.

## Redialing

The ›Redial‹ command requests "Redial".

## Deleting an entry

You can delete any entry from the voice phone book.

1. ›Delete name‹.  
The dialog for deleting an entry is opened.
2. Say the name when prompted.
3. Confirm the prompt with ›Yes‹.

## Deleting all entries\*

›Delete phone book‹ deletes all entries in the phone book.

1. ›Delete phone book‹.  
The dialog for deleting the phone book is opened.
2. Confirm the prompt with ›Yes‹.
3. Confirm the repeated prompt with ›Yes‹.

## Notes

 The voice commands in English were available as of this printing. Other languages are currently not available. To operate the portable phone via the voice command system, refer to page 22. ◀

## Important for voice commands

For voice commands, bear the following in mind:

- ▷ Issue the commands fluently and at normal volume, avoiding excessive emphasis and pauses.
- ▷ Keep the doors, windows and glass sunroof closed to prevent interference from ambient noise.
- ▷ Avoid other sources of noise in the vehicle while speaking, and ask other vehicle occupants to refrain from talking while you are using the system.

# TeleService\* , BMW Assist\*

## TeleService

TeleService supports you in communicating with your BMW center. The installed car phone can be used to transmit data on the service status of your vehicle or on legally mandated inspections directly to your BMW center. These are the same data which are stored in the master key for CBS Condition Based Service. Your BMW center can then contact you, and you can make an appointment that suits you while you are still on the road. Your advantage is that your BMW center can prepare in advance for the required maintenance work. The TeleService functions are country-specific and depend on the contract: the data on the service status of your vehicle or on legally mandated inspections is transmitted on a country-specific basis either automatically before they fall due or simultaneously when you call your BMW center. Your BMW center will be glad to provide more detailed information.

## BMW Assist

With BMW Assist, other services are available to you in addition TeleService, e.g. the your vehicle's position data can be transmitted to the BMW Assist response center when an emergency call\* has been initiated.

Many functions of BMW Assist depend on the individually agreed contract. The data transmission, e.g. of CBS Condition Based Service, is different in individual countries.

The subscriber agreement must be completed successfully before using the BMW Assist services.

## Requirements

The installed car phone is logged on to a portable telephone network. This network must be capable of transmitting the services.

To transmit position data, the vehicle must be able to determine the current position. This is displayed on the Control Display. In order to enable and update TeleService or BMW Assist, a GPS signal must be present.

## Enabling TeleService or BMW Assist

For you to be able to use the services of TeleService or BMW Assist, these must be enabled.

Leave the ignition key in position 1 during the entire operation.

Control Center, for principle details, refer to page 16.

1. Press **MENU** button.  
This opens the start menu.



2. Press controller to open the **i** menu.
3. Select "Communication settings" and press the controller.
4. Select "BMW Service settings" and press the controller.





5. Select "Service Status" and press the controller.



6. Select "Enable services" and press the controller.

TeleService and, if applicable, BMW Assist is enabled; data exchange with the service center starts.



Enabling takes a few minutes. The status is displayed on the Control Display. If you open another menu, the enable process continues to run in the background.

## Services offered

The following special aspects apply to the services of TeleService and BMW Assist:

- ▷ The range of services offered varies from country to country.
- ▷ Voice contact is established or data are transferred in dependence on the equipment and the country. In some countries both are also possible.
- ▷ The data that is transferred can be the vehicle data, your current position or the data of CBS Condition Based Service.

## Automatic service notification\*

The data on the service status of your vehicle or on legally mandated inspections is transmitted automatically directly to your BMW center prior to the due date. You can check when the BMW center is notified.

Control Center, for principle details, refer to page 16.

1. Open start menu.
2. Press controller to open the **i** menu.
3. Select "Service" and press the controller.
4. Select "Service requirements" and press the controller.

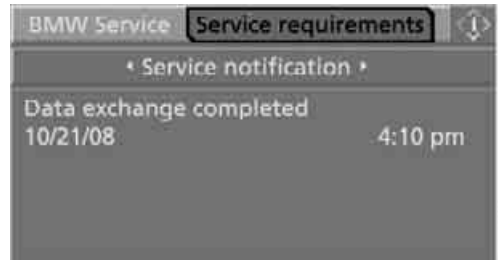

5. Select "Service notification" and press the controller.

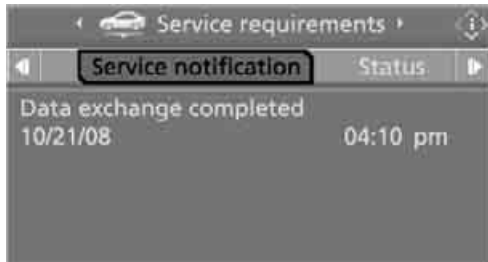

5. Select "Roadside Assistance" and press the controller.



## Breakdown assistance

You can call the Roadside Assistance\* of the BMW Group should you require help in the event of a breakdown.

Control Center, for principle details, refer to page 16.

1. Open start menu.
2. Press controller to open the **i** menu.
3. Select "Service" and press the controller.

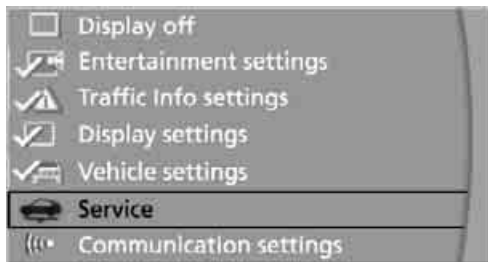

4. Select "BMW Service" and press the controller.



If the current position can be determined, the current vehicle position is displayed.

6. Select "Start service" and press the controller.



Contact to Roadside Assistance will be established.

## Setting up contact to your BMW center or BMW Customer Relations

You can contact your BMW center, e.g. to arrange a service appointment.

For information related to your vehicle, call the BMW Customer Relations.

Control Center, for principle details, refer to page 16.

1. Open start menu.
2. Press controller to open the **i** menu.
3. Select "Service" and press the controller.
4. Select "BMW Service" and press the controller.

5. Select the desired BMW center.

- ▷ "Service Request"
- ▷ "Customer Relations"

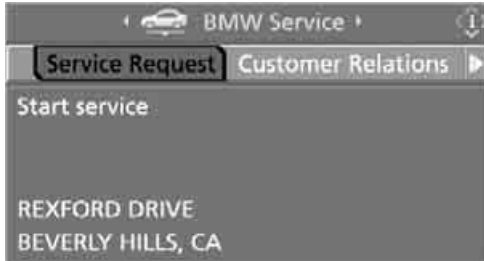

6. Press the controller.

7. Select "Start service" and press the controller.

Contact to the desired BMW center is established.

## Adapting TeleService or BMW Assist

### Displaying and updating services

You will be informed about the changes in the scope of TeleService or BMW Assist. In this case, you should update the services.

Control Center, for principle details, refer to page 16.

1. Open start menu.
2. Press controller to open the **i** menu.
3. Select "Communication settings" and press the controller.
4. Select "BMW Service settings" and press the controller.
5. Select "Service Status" and press the controller.

The current TeleService or BMW Assist services will be displayed.

6. "Options" and press the controller.

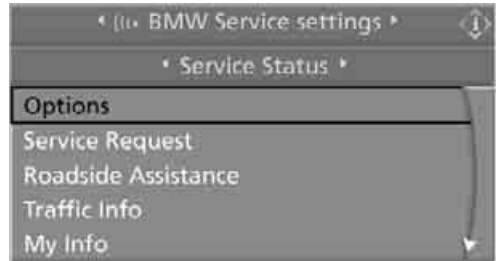

7. Select "Update services" and press the controller.

### Terminating services

If you terminate the services, your vehicle will not be equipped to contact the BMW Assist call center.

Control Center, for principle details, refer to page 16.

1. Open start menu.
2. Press controller to open the **i** menu.
3. Select "Communication settings" and press the controller.
4. Select "BMW Service settings" and press the controller.
5. Select "Service Status" and press the controller.
6. Select "Terminate services" and press the controller.

Use of TeleService or BMW Assist is blocked. To lift the block, re-enabling is required, refer to page 159. This does not affect the contractual agreements.

Automatic service notification can be disabled separately. Contact your BMW center for assistance.

Enable TeleService and, if applicable, BMW Assist to log on again.

## Displaying vehicle data

When TeleService or BMW Assist is activated, the color designation, the license plate and the vehicle identification number of your vehicle can be displayed.

Control Center, for principle details, refer to page 16.

1. Open start menu.
2. Press controller to open the **i** menu.
3. Select "Communication settings" and press the controller.
4. Select "BMW Service settings" and press the controller.
5. Select "Profile" and press the controller.



To adapt the license plate number, please contact your BMW center.





## Mobility

This section helps you maintain your mobility by supplying important information on vital topics including fuels and lubricants, wheels and tires, service, maintenance and breakdown assistance.

# Refueling

**⚠** Always switch off the engine before refueling. If you do not, fuel cannot be dispensed into the tank and a message on the Control Display will appear. ◀

**⚠** Always observe all applicable precautions and regulations when handling fuels. Never carry spare fuel containers in your vehicle. Whether empty or full, these containers can leak, cause an explosion, and lead to fire in the event of a collision. ◀

## Fuel filler door

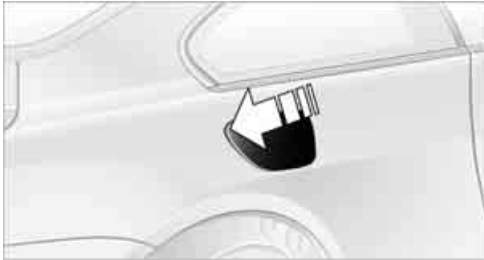

To open and close: briefly press the rear edge of the fuel filler door.

## Manual release

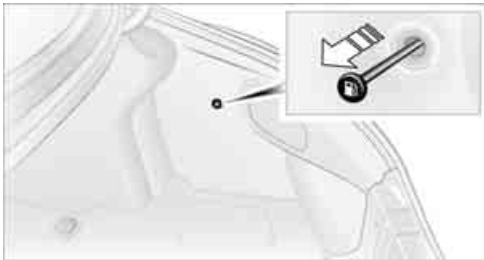

In the event of an electrical malfunction in the system, you can release the fuel filler door manually:

In the luggage compartment, pull the knob with the gas pump symbol on the right side panel.

## Observe following when refueling

**⚠** When handling fuels always observe any safety guidelines posted at the gas station. ◀

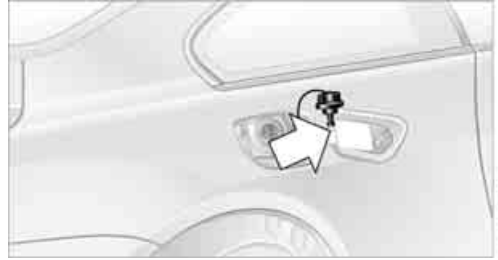

Put the fuel filler cap in the bracket attached to the fuel filler door.

When refueling, insert the filler nozzle completely into the filler pipe. Lifting the filler nozzle during refueling

- ▷ results in premature pump shutoff
- ▷ can lead to reduced efficiency in the fuel-vapor recovery system

The fuel tank is full when the filler nozzle clicks off the first time.

## Fuel tank capacity

Approx. 18.5 US gallons/70 liters, including the reserve capacity of approx. 2.1 gallons/8 liters.

**⚠** Refuel as soon as possible once your cruising range falls below 30 miles/ 50 km, as otherwise engine functions are not ensured and damage can occur. ◀

## Closing fuel filler cap

Fit the cap and turn it clockwise until you clearly hear a click.

**⚠** Close the fuel filler cap carefully after refueling, continuing until a click is heard. While closing, be sure not to squeeze the strap which is fastened to the cap. A loose or missing cap will activate an indicator lamp and the message Check Gas Cap\* on the Control Display. ◀



## Fuel specifications

The engine uses unleaded gasoline only.

### Required fuel

#### Premium unleaded gasoline

The minimum octane rating is 91.

If you use gasoline with this minimum octane rating, the engine may produce knocking sounds when starting at high outside temperatures. This has no effect on the engine life.

Minimum Octane Rating corresponds to the Anti Knock Index AKI and is determined according to the so-called (R+M)/2 method.



Do not use leaded gasoline, as otherwise the lambda probe and catalytic converter will be permanently damaged. ◀

### Use high-quality brands

Field experience has indicated significant differences in fuel quality: volatility, composition, additives, etc., among gasolines offered for sale in the United States and Canada. Fuels containing up to and including 10% ethanol or other oxygenates with up to 2.8% oxygen by weight, that is, 15% MTBE or 3% methanol plus an equivalent amount of co-solvent, will not void the applicable warranties with respect to defects in materials or workmanship.



The use of poor-quality fuels may result in drivability, starting and stalling problems, especially under certain environmental conditions such as high ambient temperature and high altitude.

Should you encounter drivability problems which you suspect could be related to the fuel you are using, we recommend that you respond by switching to a recognized high-quality brand.

Failure to comply with these recommendations may also result in unscheduled maintenance. ◀



# Wheels and tires

## Tire inflation pressure

### Information for your safety

It is not merely the tire's service life, but also driving comfort and – to a great extent – driving safety that depend on the condition of the tires and the maintenance of the specified tire pressure.

### Checking tire inflation pressure

Only check tire inflation pressure when the tires are cold. This means after a maximum of 1.25 miles/2 km driving or when the vehicle has been parked for at least 2 hours. When tires are warm, the tire inflation pressure increases.

 Check the tire inflation pressure regularly and correct it if necessary: at least every two weeks and before beginning a longer trip. If you fail to observe this precaution, you may be driving on tires with incorrect tire pressures, a condition that can not only compromise your vehicle's stability, but also lead to tire damage and the risk of an accident. ◀

 After correcting the inflation pressure(s), always reinitialize the Flat Tire Monitor, refer to page 84. ◀

### Pressure specifications for factory-installed tires



The tire inflation pressures with the ambient temperature are visible on the door pillar with the driver's door open.

### Pressure specifications for other tire sizes

The tables below provide all the correct inflation pressures for the specified tire sizes at ambient temperature.

 For correct identification of the right tire inflation pressure for your tires, observe the specifications for the corresponding tire size. ◀

### Tire size

The specified pressures apply to tire sizes approved by BMW and recommended tire makes; your BMW center will be glad to provide information.

## 645Ci Coupe

Tire size	Pressure specifications in psi/kPa			
All pressure specifications in the table are indicated in psi/ kilopascal with cold tires – cold = ambient temperature				
245/50 R 17 99 H M+S				
245/45 R 18 96 V M+S	29/200	32/220	33/230	39/270
245/45 R 18 96 V M+S all season				
Front: 245/45 R 18 96 W	29/200	–	33/230	–
Rear: 275/40 R 18 99 W	–	32/220	–	39/270
Front: 245/40 R 19 94 W	29/200	–	33/230	–
Rear: 275/35 R 19 96 W	–	32/220	–	39/270
Front: 245/35 R 20 91 Y	29/200	–	33/230	–
Rear: 275/30 R 20 93 Y	–	32/220	–	39/270

More details on the permitted load and weights can be found on page [192](#).

## 645Ci Convertible

Tire size	Pressure specifications in psi/kPa			
All pressure specifications in the table are indicated in psi/ kilopascal with cold tires – cold = ambient temperature				
245/50 R 17 99 H M+S				
245/45 R 18 96 V M+S	32/220	38/260	39/270	46/320
245/45 R 18 96 V M+S all season				
Front: 245/45 R 18 96 W	32/220	–	39/270	–
Rear: 275/40 R 18 99 W	–	38/260	–	46/320
Front: 245/40 R 19 94 W	32/220	–	39/270	–
Rear: 275/35 R 19 96 W	–	38/260	–	46/320
Front: 245/35 R 20 91 Y	32/220	–	39/270	–
Rear: 275/30 R 20 93 Y	–	38/260	–	46/320

More details on the permissible load and weights can be found on page [192](#).

## Tire identification marks

Knowledge of the labeling on the side of the tire makes it easier to identify and choose the right tires.

### Tire size

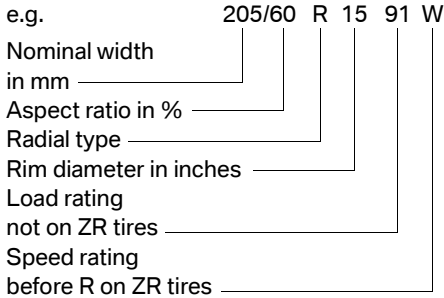

### Speed letter

- T = up to 118 mph/190 km/h
- H = up to 131 mph/210 km/h
- V = up to 150 mph/240 km/h
- W = up to 167 mph/270 km/h
- Y = up to 186 mph/300 km/h

### Tire Identification Number

Tires with DOT codes meet the guidelines of the U.S. Department of Transport.

DOT code:

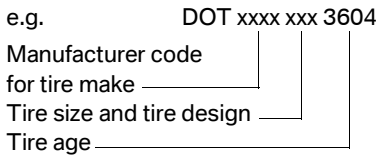

### Tire age

The tire's date of manufacture is indicated on the sidewall:

DOT ... 3604 indicates that a tire was manufactured in week 36 of the year 2004.

BMW recommends replacing all tires at least every 6 years, even if some tires may last for 10 years.

## Uniform Tire Quality Grading

Quality grades can be found where applicable on the tire sidewall between tread shoulder and maximum section width. For example:

Tread wear 200 Traction AA  
Temperature A

### DOT Quality Grades

Tread wear  
Traction AA A B C  
Temperature A B C



All passenger car tires must conform to Federal Safety Requirements in addition to these grades. ◀

### Tread wear

The tread wear grade is a comparative rating based on the wear rate of the tire when tested under controlled conditions on a specified government test course.

For example, a tire graded 150 would wear one and one-half, 1½, times as well on the government course as a tire graded 100. The relative performance of tires depends upon the actual conditions of their use, however, and may depart significantly from the norm due to variations in driving habits, service practices and differences in road characteristics and climate.

### Traction

The traction grades, from highest to lowest, are AA, A, B, and C.

Those grades represent the tire's ability to stop on wet pavement as measured under controlled conditions on specified government test surfaces of asphalt and concrete. A tire marked C may have poor traction performance.



The traction grade assigned to this tire is based on straight-ahead braking traction tests, and does not include acceleration, cornering, hydroplaning, or peak traction characteristics. ◀

### Temperature

The temperature grades are A, the highest, B, and C, representing the tire's resistance to the generation of heat and its ability to dissipate

heat when tested under controlled conditions on a specified indoor laboratory test wheel. Sustained high temperature can cause the material of the tire to degenerate and reduce tire life, and excessive temperature can lead to sudden tire failure. The grade C corresponds to a level of performance which all passenger car tires must meet under the Federal Motor Vehicle Safety Standard No. 109. Grades B and A represent higher levels of performance on the laboratory test wheel than the minimum required by law.

 The temperature grade for this tire is established for a tire that is properly inflated and not overloaded. Excessive speed, underinflation, or excessive loading, either separately or in combination, can cause heat buildup and possible tire failure. ◀

### RSC – run-flat tires

You will recognize run-flat tires by a circular symbol containing the letters RSC on the side of the tire, refer to page 172.

### M+S

Winter and all-season tires. These have better winter properties than summer tires.

## Tire condition

Inspect your tires frequently for tread wear, signs of damage and foreign objects lodged in the tread, and check the tread depth.

### Minimum tread depth

The tread depth should not drop below 0.12 in/3 mm, although, for example, European legislation only specifies a minimum tread depth of 0.063 in/1.6 mm.

At tread depths below 0.12 in/3 mm there is an increased risk of high-speed hydroplaning, even when only small amounts of water are present on the road surface.

Winter tires noticeably lose their suitability for winter use below a tread depth of 0.16 in/4 mm.

New tires should be mounted in the interest of safety.

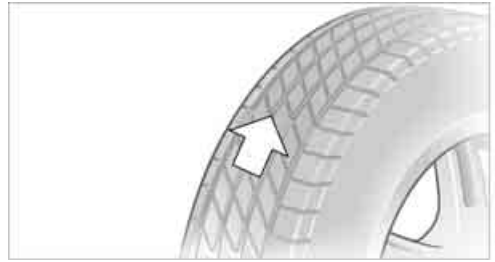

Wear indicators at the tread-groove base, refer to arrow, are distributed over the tire's circumference and are marked on the side of the tire with TWI – Tread Wear Indicator. If the indicators are at the level of the profile, the legal permissible tread depth of 0.063 in/1.6 mm has been reached.

### Tire damage

 Due to low-profile tires, please note that wheels, tires and suspension parts are more susceptible to road hazard and consequential damages.

Unusual vibrations encountered during normal vehicle operation can indicate tire failure or some other vehicle defect. This can, for example, be caused by driving over curbs. These kinds of problems may also be signaled by other changes in vehicle response, such as a strong tendency to pull to the left or right.

In these cases reduce your speed immediately and have the wheels and tires inspected immediately. To do this, carefully drive to the next BMW center or a specialized tire dealer which works with personnel trained in accordance with BMW specifications. Have the vehicle towed to the workshop if necessary. Tire damage can be extremely dangerous to vehicle occupants and other road users. ◀

 Unprofessional attempts by laymen to service tires can lead to damage and accidents. Have this work performed by skilled professionals only. The technicians at your BMW center will be glad to assist you with the required professional knowledge and specialized equipment. ◀

## Run-flat tires



You will recognize run-flat tires by the circular symbol containing the letters RSC on the sidewall.

Run-flat tires consist of self-contained tires and special rims. The sidewall reinforcement ensures that the tire retains some residual safety in the event of pressure drop and driving remains possible to a restricted degree.

## New wheels and tires

**⚠** Only have new wheels and tires mounted by a BMW center or a specialized tire dealer which works with personnel trained in accordance with BMW specifications. If this work is performed inexpertly, there is a danger of damage and associated safety risks. Make sure that the new wheels are balanced. ◀

## Retreaded tires

**⚠** BMW does not recommend the use of retread tires, as otherwise driving safety may be reduced. Possible variations in the design and the age – which could be substantial – of the carcasses can lead to more rapid wear. ◀

## The right wheels and tires

If you switch from summer to winter tires, or vice versa, use run-flat tires, as in the event of a flat tire there is no spare tire available. Your BMW center will be glad to advise you.

**⚠** For safety reasons, BMW recommends that you do not have damaged run-flat tires repaired; they should be replaced. ◀

**⚠** BMW recommends that you use only wheel and tire combinations that BMW has tested and approved for your particular vehicle. Variations in factors such as manufacturing tolerances mean that even wheels and tires with identical official size ratings could actually have different dimensions than the approved units – these differences could lead to body contact, and with it the risk of severe accidents. If non-approved wheels and tires are used, BMW cannot evaluate their suitability, and therefore cannot be held liable for driving safety. ◀

You can find out the right wheel-tire combination from your BMW center.

The right wheel-and-tire combination is another vital factor in ensuring reliable operation of various vehicle systems such as ABS and DSC.

To maintain good handling and vehicle response, use only tires of a single tread configuration from a single manufacturer. After a flat tire, always remember to have the specified wheel and tire combination remounted on the vehicle as soon as possible.

## Recommended tire brands

BMW tests certain tire brands for each tire size, classifies them as road-safe and approves them. Consult your BMW center for more information. Observe any country-specific regulations, e.g. on making a corresponding entry in the vehicle documents.

The factory-mounted tires have been specially selected to provide optimized performance when installed on your vehicle; if properly cared for, they will provide a combination of safety and excellent ride comfort.

## Special characteristics of winter tires

BMW recommends winter tires for use in cold winter driving conditions. Although all-season M+S tires provide better winter traction than summer tires, they generally fail to provide the same levels of cold-weather performance as winter tires.

## Run-flat tires

If you switch from summer to winter tires, or vice versa, use run-flat tires, refer to page 172, as in the event of a flat tire there is no spare tire available. Your BMW center will be glad to advise you.

## Watch speed



Observe the permissible maximum speed for the respective winter tires, as otherwise tire damage occurs and causes accidents. ◀

## Storage

Always store wheels and tires in a cool, dry place with as little exposure to light as possible. Always protect tires against all contact with oil, grease and fuels. Do not exceed the maximum tire inflation pressure indicated on the side wall of the tire.

## Snow chains\*

BMW only tests certain fine-link snow chains, classifies them as road-safe and approves them. Consult your BMW center for more information. BMW recommends using these approved snow chains. These snow chains are approved exclusively for use in pairs on the rear wheels with the tire size:

- ▷ 245/50 R 17 Y
- ▷ 245/45 R 18 Y

Observe the chain manufacturer's instructions when mounting snow chains. Do not exceed a vehicle speed of 30 mph/50 km/h with the chains mounted.



Do not initialize the Flat Tire Monitor after mounting snow chains.

When you are driving with snow chains, it can be beneficial to switch off DTC briefly, refer to page 82. ◀

# Under the hood

**⚠** Never attempt to perform any service or repair operations on your vehicle without the required, professional technical training. If you are unfamiliar with the specifications to be observed, only have work carried out on your vehicle by a BMW center or a workshop which works with personnel trained in accordance with BMW specifications. Otherwise there is a danger of damage and associated safety risks if this work is performed improperly. ◀

## Hood

### Releasing



Pull the lever located under the left side of the instrument panel.

### Opening

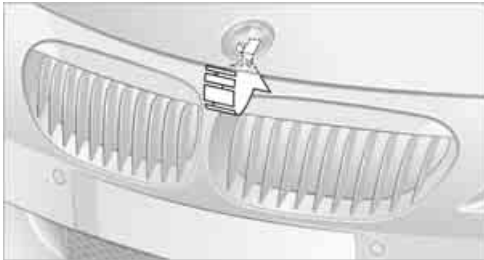

Press the release handle and open the hood.

### Closing

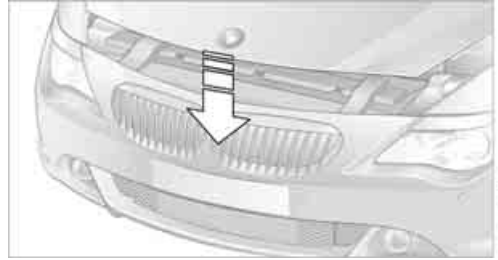

Close the hood from a height of approx. 16 in/ 40 cm with momentum. It must be clearly heard to engage.

**⚠** Make sure that the closing path of the hood is clear, as otherwise injuries may result.

If you see any signs that the hood is not completely closed while you are driving your vehicle, you should stop at once and close it securely. ◀

## Engine compartment

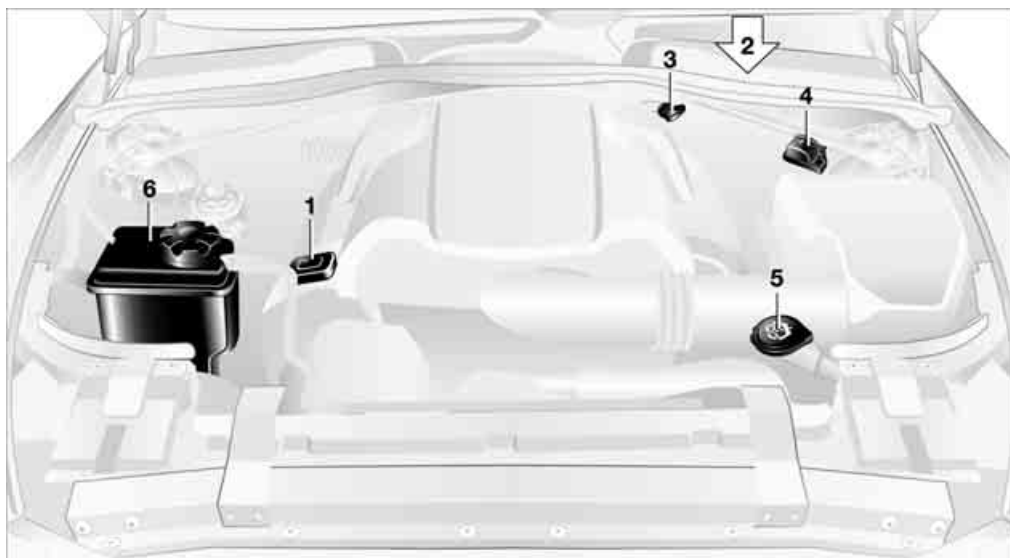

- 1 Filler neck for engine oil, refer to Topping off engine oil
  - 2 Brake fluid reservoir, located beneath the microfilter cover, refer to page 177
  - 3 Dipstick for engine oil, refer to Checking oil level
  - 4 Starting-aid terminal, refer to page 186
  - 5 Washer fluid reservoir of the headlamp and windshield cleaning systems, refer to page 61
  - 6 Expansion tank for coolant, refer to page 176
3. After approx. 5 minutes, pull the dipstick **3** out and wipe it off with a clean lint-free cloth, paper towel, or similar material.
  4. Carefully push the dipstick all the way into the guide tube and pull it out again. The oil should extend to between the two marks on the dipstick.

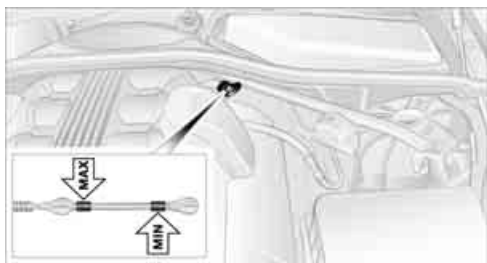

## Engine oil

The engine oil consumption is dependent on driving style and driving conditions.

### Checking oil level

1. Park the vehicle on a level surface with the engine warm, i.e. after an uninterrupted drive of at least 6 miles/10 km.
2. Switch off the engine.

The oil quantity between the centers of the two marks on the dipstick, refer to arrows, is approx. 1.6 US quarts/1.5 liters.

 Do not fill beyond the upper mark on the dipstick. Excess oil can damage the engine. ◀



## Topping off engine oil

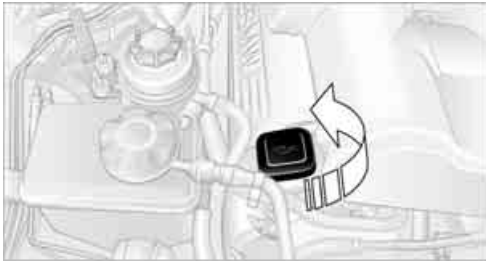

Wait until the level has dropped to just above the lower dipstick mark before adding oil. When it falls to this level, a message also appears on the Control Display.

 Refill the oil within the next 125 miles/ 200 km, otherwise engine damage could result. ◀

 Store oil, grease etc., well out of the reach of children; always observe all warning labels on the containers. ◀

## Oil change

Have oil changes carried out only by a BMW center.

## Specified engine oils

The quality of the engine oil selected has critical significance for the operation and service life of an engine. BMW continuously approves specific oils after confirming their suitability for use in its vehicles with extensive testing.

Use only approved BMW High Performance Synthetic Oil.

If you are unable to obtain BMW High Performance Synthetic Oil, you can add small amounts of another synthetic oil between oil changes. Use only oils with the API SH specification or higher.

 Ask your BMW center for details concerning the specific BMW High Performance Synthetic Oil or synthetic oils which have been approved. ◀

You can also call BMW of North America at 1-800-831-1117 or visit this website: [www.bmwusa.com](http://www.bmwusa.com) to obtain this information.

 BMW engines are designed to operate without additives, and their use could even lead to damage in some cases. ◀

## Viscosity ratings

Viscosity is the oil flow rating as defined in SAE classes.

The selection of the correct SAE class depends on the climatic conditions in the area where you typically drive your BMW.

 Approved oils are in SAE classes 5W-40 and 5W-30. ◀

These oils may be used for driving in all ambient temperatures.

## Coolant

 Do not open the cooling system when the engine is hot. Escaping coolant can cause burns. ◀

Coolant consists of water and coolant additive. Not all commercially available additives are suitable for your BMW. Ask your BMW center for suitable additives.

 Only use suitable additives, as otherwise engine damage may result. The additives present a health hazard. ◀

 Always observe all applicable environmental laws and regulations when disposing of used coolant additives. ◀

## Checking coolant level

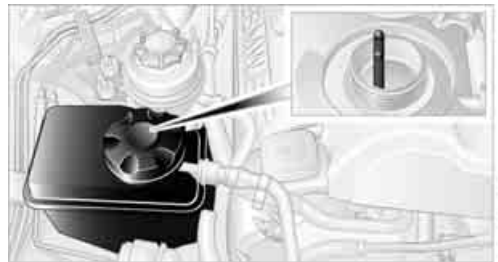

1. The engine must be at ambient temperature.

2. Turn the cap of the expansion tank counter-clockwise to allow any accumulated pressure to escape, then continue turning to open.
3. The coolant level is correct when it lies between the Min and Max mark, also refer to the drawing next the filler neck.
4. If the coolant is low, slowly add coolant up to the specified level – do not overfill.
5. Turn the cap until it clicks.
6. Have the reason for the coolant loss eliminated as soon as possible.

## Brake system

### Malfunction

#### Brake fluid

 The warning lamp lights up in red in spite of the handbrake being released; a message appears on the Control Display.

Stop the vehicle immediately.

The brake fluid in the reservoir has fallen to below the minimum level. At the same time, a significantly longer brake pedal path may be noticeable. Have the system checked immediately by a BMW center.

 Warning lamp for Canadian models.

 When you continue driving, an increased brake pedal path can be necessary, and significantly longer braking distances might be required. Please adapt your driving style accordingly. ◀

#### Brake pads

 The warning lamp lights up in red in spite of the handbrake being released; a message appears on the Control Display. The brake pads have reached their minimum pad thickness. Have the brake pads replaced as soon as possible.



Warning lamp for Canadian models.



For your own safety: use only brake pads that BMW has approved for your particular vehicle model. As BMW cannot assess the suitability of other brake pads for use on your vehicle, BMW is unable to assume continued responsibility for the vehicle's operating safety if non-approved pads are installed. ◀

# Maintenance

## The BMW Maintenance System

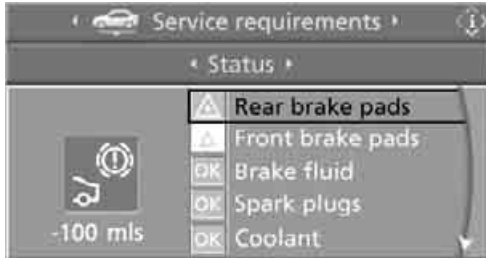

The BMW maintenance system supports the preservation of the traffic and operating safety of your BMW. The service schedule also includes operations related to the vehicle's comfort and convenience features, such as replacement of the filters for the inside air. The ultimate objective is to ensure economical maintenance by providing the ideal service for your vehicle.

Should the day come when you decide to sell your BMW, you will find that a complete dealer service history is an asset of inestimable value.

### CBS Condition Based Service

Sensors and special algorithms take the different driving conditions of your BMW into account. Condition Based Service uses this to determine the current and future service requirements. By letting you define a service and maintenance regimen that reflects your own individual requirements, the system builds the basis for trouble-free driving.

You can set the Control Display to show remaining times or distances of selected maintenance intervals and legally mandated deadlines, refer to page 70:

- ▷ Engine oil
- ▷ Brakes, front and rear separately
- ▷ Microfilter/activated-charcoal filter
- ▷ Brake fluid

- ▷ Spark plugs
- ▷ Vehicle check
- ▷ Legally required tests depending on local regulations

Your vehicle stores this information continuously in the master key while the vehicle is being driven. After accessing the data stored in the master key, your BMW Service Advisor can suggest precisely the right array of service procedures for your own individual vehicle. You should therefore give your BMW Service Advisor the key you last used to drive when you take your vehicle in for service.

 Make sure the date in the Control Center is always set correctly, refer to page 78, as otherwise the effectiveness of CBS Condition Based Service is not ensured. ◀

### Service and Warranty Information Booklet for US models and Warranty and Service Guide Booklet for Canadian models

Please consult your Service and Warranty Information Booklet for US models and Warranty and Service Guide Booklet for Canadian models for additional information regarding service requirements.

 Have service and repair operations performed at your BMW center.

Take the time to ensure that these service procedures are confirmed by entries in your vehicle's Service and Warranty Information Booklet for US models and Warranty and Service Guide Booklet for Canadian models. These entries verify that your vehicle has received the specified regular maintenance, and may also be required when submitting warranty claims. ◀

## OBD Socket



The Onboard Diagnostics OBD interface socket is located on the left of the driver's side under the instrument panel and under a cover. The cover has the letters OBD on it.

The purpose of the OBD system is to ensure proper operation of the emission control system for the vehicle's lifetime. The system monitors emission-related components and systems for deterioration and malfunction.



An illuminated indicator lamp informs you of the need for service, not of the need to stop the vehicle. However, the systems should be checked by your BMW center at the earliest possible opportunity.



Display of the previously described malfunction on Canadian models.

Under certain conditions, the indicator lamp will blink or flash. This indicates a rather severe level of engine misfire. When this occurs, you should reduce speed and consult the nearest BMW center as soon as possible. Severe engine misfire over only a short period of time can seriously damage emissions control components, especially the catalytic converter.



When the fuel filler cap is not properly tightened, the OBD system can detect the vapor leak and the indicator lamp will light up. If the filler cap is subsequently tightened, the indicator lamp should go out within a few days. ◀

## Event Data Recorders

Your vehicle may be equipped with one or more sensing and diagnostic modules or a recording device capable of recording or transmitting certain vehicle data or information. In addition, if you have a Subscription Service Agreement for the BMW Assist system, certain vehicle information may be transmitted or recorded in order to provide such services.

## Care

Important information on care and maintenance of your BMW is contained in the Caring for your vehicle brochure.

# Replacing components

## Onboard tool kit

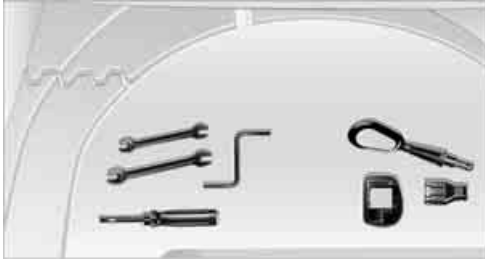

The onboard tool kit is located in the luggage compartment under the floor mat.

## Wiper blade replacement

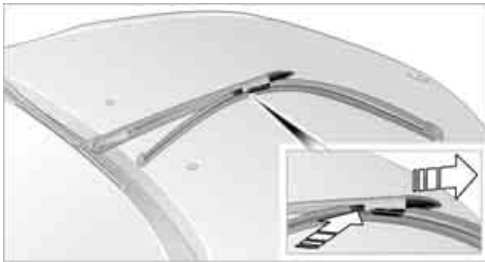

1. Fold the wiper arm out and grasp it firmly.
2. Press the locking tabs together while sliding the wiper blade toward the front to disengage it.

## Lamps and bulbs

Lamps and bulbs make an essential contribution to driving safety. Therefore, exercise sufficient care when handling them. If you are not familiar with the specified procedures, have the corresponding work carried out at your BMW center.

 Never touch the glass on new bulbs with your bare fingers, as even minute amounts of contamination will burn into the bulb's surface and reduce its service life. Use a clean cloth, napkin etc., or hold the bulb by its metal socket. ◀

You can obtain a selection of replacement bulbs at your BMW center.

 When working on the lighting system you should always switch off the lights affected to prevent short circuits.

To avoid possible injury or equipment damage when replacing bulbs, observe any instructions provided by the bulb manufacturer. ◀

When performing maintenance on the headlamps, comply with the instructions in the separate Caring for your vehicle brochure.

 In the case of bulbs where the replacement is not described, please consult your BMW center. ◀

## Xenon lamps

The service life of these lamps is very long and the probability of a failure is very low, provided that they are not switched on and off an unusual number of times. In the unlikely event that one of these lamps should fail, you can continue driving under poor visibility conditions by switching on your fog lamps and proceeding carefully, where allowed by law.

 To avoid the risk of potentially fatal injuries: owing to the extremely high voltages at which these units operate, service work on the xenon lighting system should only be carried out by a BMW center. ◀

## High beams, parking lamps

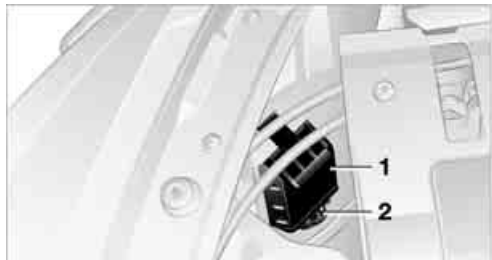

The illustration shows the front left side of the engine compartment.

### High beams

Bulb 55 watts, H 7

1. Remove the cover cap **1** by pressing the tab and removing the cover cap upward.
2. Press the bulb holder from above to release it.
3. Remove the bulb holder.
4. Remove and replace the bulb.

### Parking lamps

Bulb 10 watts



Bulb holder and reflector are one unit and are replaced together. ◀

1. Turn the bulb holder **2** to the right and remove.
2. Press the snap connection on the plug connector, pull off the bulb holder and replace.

### Front turn signal, sidemarker

Your BMW is equipped with two turn signal lamps per side in the front.

#### Turn signal lamp 1

Bulb 21 watts, WY 21 SV

The illustration shows the front right side of the engine compartment.

1. The lever shown:
  - ▷ Right turn signal: press downward
  - ▷ Left turn signal: press upward



2. Remove the bulb holder towards the rear.
3. Remove and replace the bulb.

#### Turn signal lamp 2

Bulb 21 watts, WY 21 SV

Bulb replacement for the turn signal lamp 2 is possible via the wheel well.

The illustration shows the left side of the vehicle.

1. Turn the steering all the way to be able to remove the cover, refer to illustration.
2. Turn the ignition key to position 0.
3. Unscrew the two bolts using the open-end wrench from the onboard tool kit, refer to page 180.
4. Turn the bulb holder to the left and remove, refer to arrow.



5. Remove and replace the bulb.

## Sidemarkers

Bulb 5 watts, WY5W ST

The bulb can be replaced via a cover at the front of the wheel well, refer to the description for turn signal lamp 2.

1. The bulb holder of the sidemarkers lamp is located toward the outside of the vehicle next to the bulb holder of turn signal lamp 2.
2. Turn the bulb holder to the left and remove.
3. Remove and replace the bulb.

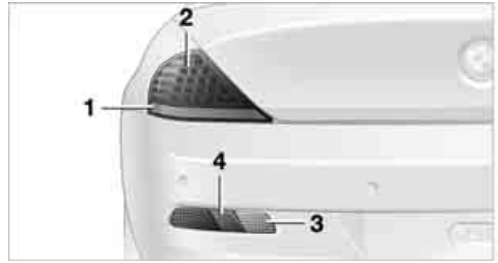

- 1 Turn signals
- 2 Roadside parking, rear and brake lamp
- 3 Backup lamp
- 4 Reflector

## Side turn signals

Bulb 5 watts, WY 5 W

1. Press against the front edge of the lamp with the tip of your finger, then push it to the rear, release the snap connection at the front and take it off the trim strip.

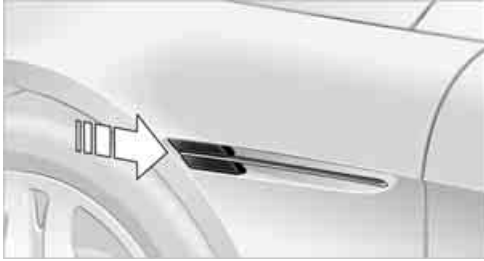

2. Turn the bulb holder 90° to the left and remove.
3. Remove and replace the bulb.

## Tail lamps

 The roadside parking, rear and brake lamps are LEDs. The backup lamps are fitted with longlife bulbs. Please contact a BMW center in case of a malfunction. ◀

## Rear turn signals



Bulb 21 watts, PY 21 W

The illustration shows the recess on the left side of the luggage compartment.

1. Remove the cover.
2. Unclip the bulb holder and remove.
3. Apply gentle pressure to the bulb while turning it to the left for removal and replacement.

## License plate lamps



Bulb 5 watts, WY 5 W

1. Push a screwdriver from the left under the lamp and lever up the lamp to the right.
2. Turn the bulb holder 90° to the left and remove.
3. Remove and replace the bulb.

### LEDs Light-emitting diodes

Light-emitting diodes installed behind translucent lenses serve as the light source for many of the controls and displays in your vehicle. These light-emitting diodes, which operate using a concept similar to that applied in conventional lasers, are officially designated as Class 1 light-emitting diodes.

 Do not remove the covers, and never stare into the unfiltered light several hours, as irritation of the retina could result. ◀

## Changing a wheel

Your BMW is equipped with run-flat tires as standard. An immediate wheel change in the event of a flat tire is therefore no longer required.

You will recognize run-flat tires by a circular symbol containing the letters RSC on the side of the tire, refer to Run-flat tires on page 171.

If you have new tires mounted or switch from summer to winter tires, or vice versa, use run-flat tires, as in the event of a flat tire there is no spare tire available. Your BMW center will be glad to advise you.

Also refer to New wheels and tires, page 172.

## Car jacking points

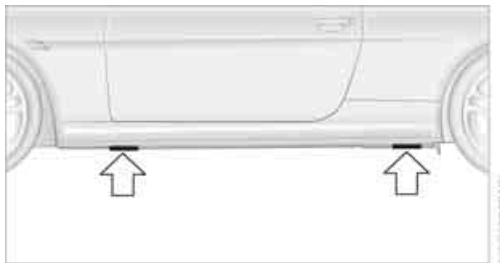

The jacking points for the car jack are located in the positions shown.

 The suitable tools for changing tires are available as accessories from your BMW center. ◀

## Vehicle battery

### Battery care

The battery is 100% maintenance-free, i.e., the electrolyte will last for the life of the battery when the vehicle is operated in a temperate climate.

Your BMW center will be glad to advise in all matters concerning the battery.

### Charging battery

Only charge the battery in the vehicle via the terminals in the engine compartment with the engine switched off. For the connections, refer to Jump starting on page 186.

### Disposal

 After replacement, have old batteries disposed of by your BMW center or deposit them at a recycling center. Maintain the battery in an upright position for transport and storage. Always secure the battery to prevent it from tipping over during transport. ◀



## Power failure

Following a temporary interruption of the power supply, the operation of some equipment is limited and must be reinitialized. Individual settings are also lost and have to be updated:

- ▷ Active steering  
The system is deactivated and has to be initialized, refer to page 86. Until then, the steering will react in an unaccustomed manner.
- ▷ Seat, mirror and steering wheel memory  
The position must be stored again, refer to page 46.
- ▷ Time and date  
The settings must be updated, refer to page 78.
- ▷ Radio  
Radio stations have to be stored again, refer to page 138.
- ▷ Navigation system  
You must wait until it becomes operational again, refer to page 129.

## Fuses

 Never attempt to repair a blown fuse, and do not replace a defective fuse with a substitute of another color or amperage rating, as this could lead to overloading of the wiring, ultimately resulting in a fire in the vehicle. ◀

Spare fuses and a pair of plastic tweezers are located in the compartment for the onboard tool kit, refer to page 180.

Information on fuse allocation is located below the bracket for the onboard tool kit, see below.

## In glove compartment

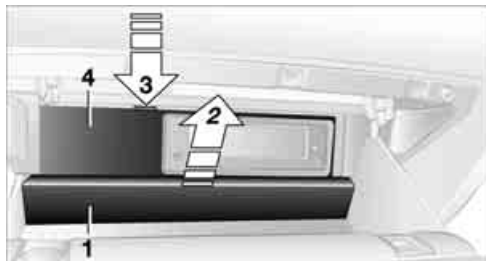

1. Press the button on the back in the center of partition 1 and pull out the partition upward, arrow 2.
2. Press the coupling downward, arrow 3, and fold the lid 4 forward.

## In luggage compartment

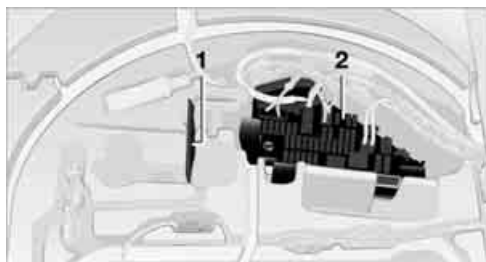

Fold up the cover under the floor mat and remove the bracket for the onboard tool kit. Information on fuse allocation 1 and additional fuses 2 are provided there.

# Giving and receiving assistance

## Emergency call\*

Conditions for an emergency call:

- ▶ Ignition key in position 1 or greater.
- ▶ The car phone is logged on to a portable telephone network.
- ▶ The emergency call system is operable.

Coupe: emergency call button.



Convertible: emergency call button.



## Initiating emergency call

1. To open the protective cover of the emergency call button:  
Briefly press the protective cover.
2. Press the emergency call button for at least 2 seconds.

The indicator lamp in the button lights up. As soon as the voice connection to the BMW Assist response center has been established, the indicator lamp flashes.

If conditions allow, remain in the vehicle until the connection has been established. You will then be able to provide a detailed description of the situation.

In vehicles with BMW Assist enabled, if the current position of your vehicle can be determined, it will be transmitted to the BMW Assist response center.

Enabling BMW Assist, refer to page 159.

If the indicator lamp flashes, but you are unable to hear the BMW Assist response center through the hands-free system, this could indicate, for instance, that the hands-free system is no longer operational. However, the BMW Assist response center may then still be able to hear you.

Under certain conditions, an emergency call is initiated automatically immediately after a severe accident. An automatic emergency call is not affected by the emergency call button being pressed.



For technical reasons, the emergency call cannot be guaranteed under unfavorable conditions. ◀

## Warning triangle\*



The warning triangle can be found in the luggage compartment on the left side.

-  Comply with legal requirements requiring you to carry a hazard warning triangle in the vehicle. ◀

## First-aid kit\*

The first-aid kit is located in the filler element of the rear seat backrest.

1. Press the button downward and pull the filler element forward.



2. Take out first-aid kit.

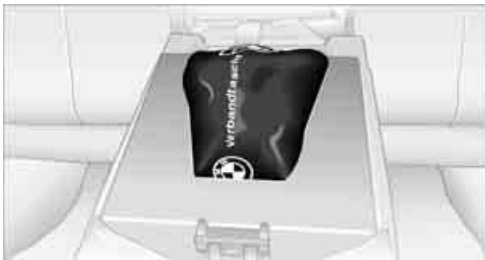

-  To refit the filler element, insert the two bottom tabs into the strip and press the filler element back into place. Make sure that you do not damage the rear seat upholstery. ◀

-  Some of the articles contained in the first-aid kit have a limited service life. For this reason, check the expiration dates of each of the items regularly and replace any whose expiration dates have passed. You can find replacements in any pharmacy.

Comply with legal requirements requiring you to carry a first-aid kit in the vehicle. ◀

## Roadside Assistance\*

The Roadside Assistance of the BMW Group offers you breakdown assistance around the clock, including on weekends and public holidays.

The phone numbers of the Roadside Assistance in your home country can be found in the BMW Contact directory.

In vehicles with BMW Assist or TeleService, you can call the Roadside Assistance of the BMW Group directly for breakdown assistance via the Control Center, refer to page 161.

## Jump starting

When your battery is discharged, you can use two jumper cables to start your BMW with power from the battery in a second vehicle. You can also use the same method to help start another vehicle. Use only jumper cables with fully-insulated clamp handles.

-  To avoid the risk of potentially fatal injury, always avoid all contact with electrical components while the engine is running. Carefully adhere to the following sequence, both to prevent damage to one or both vehicles, and to guard against possible personal injuries. ◀

## Preparing

1. Check whether the battery of the other vehicle has a voltage of 12 Volts and approximately the same capacitance in Ah. This information can be found on the battery.
2. Switch off the engine of the vehicle providing assistance.
3. Switch off all electrical accessories in both vehicles.

 There must not be any contact between the bodies of the two vehicles, as otherwise there is a danger of shorting. ◀

## Connecting jumper cables

 To avoid personal injury from sparks, observe this sequence when connecting jumper cables. ◀



In your BMW, the so-called jump-starting terminal in the engine compartment serves as the battery positive terminal, also refer to engine compartment essentials on page 175. The symbol + is embossed on the cover.

1. Fold open the cover of the BMW jump-starting terminal. To do so, pull the tab.
2. Attach one end of the jumper cable plus/+ to the positive terminal of the battery or a jump-starting terminal of the vehicle providing assistance.

3. Attach the second end of the cable to the positive terminal of the battery or to a jump-starting terminal of the vehicle to be started.



Your BMW has a special nut as body ground or negative pole.

4. Attach one end of the jumper cable minus/- to the negative terminal of the battery or to an engine or body ground of the vehicle providing assistance.
5. Attach the second end of the cable to the negative terminal of the battery or to the engine or body ground of the vehicle to be started.



## Starting engine

1. Start the engine on the assisting vehicle and allow it to run for several minutes at increased speed.
2. Start the engine on the other vehicle in the usual way. If the first start attempt is not successful, wait a few minutes before another attempt in order to allow the discharged battery to recharge.
3. Let the engines run for a few minutes.
4. Disconnect the jumper cables by reversing the connection sequence

If required, have the battery inspected and recharged at your BMW center.

 Never use spray fluids to start the engine. ◀

## Towing and tow-starting

-  Always observe all applicable towing laws and regulations. ◀
-  Never allow passengers to ride in a towed vehicle for any reason. ◀

### Use tow fitting

The threaded tow fitting is stored in the tool kit mounted on the inside of the luggage compartment under the floor mat, refer to page 180, and should always remain in the vehicle. It can be screwed in at the front or rear of the BMW.

-  To avoid damage to the tow fitting and the vehicle, observe the following: only use the tow fitting that comes with the vehicle and screw it in as far as possible. Use the tow fitting for towing only on roads. Avoid lateral strains on the tow fitting, e.g. do not lift the vehicle by the tow fitting. ◀

### Access to screw thread

Rectangular cover in bumper:  
Press the arrow symbol of the cover.

Front

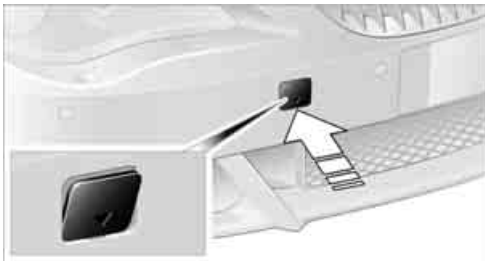

Rear



## Being towed

-  Make sure that the ignition key is in position 1, as otherwise the steering wheel could lock and it would be impossible to steer the vehicle. There is no power assist with the engine stopped. This then requires increased effort for braking and steering. Active steering is deactivated and larger steering wheel movements are required. ◀

Switch on the hazard warning flashers depending on the local regulations. If the electrical system fails, mark the vehicle to be towed, e.g. with a sign or warning triangle in the rear window.

### Vehicles with manual transmission

Gearshift lever in idle position

### Vehicles with automatic transmission

Selector lever in position N.

-  Do not exceed a towing speed of 45 mph/ 70 km/h and a towing distance of 90 miles/150 km, as otherwise the automatic transmission may be damaged. ◀

### Vehicles with SMG Sequential manual transmission

With the ignition switched on, engage selector-lever position N, then switch off the ignition.

## Towing methods

In some countries, towing with tow bars or ropes in public traffic is not permitted.

Familiarize yourself with the regulations on towing in the respective country.

### With tow bar

-  The towing vehicle may not be lighter than the vehicle to be towed, as otherwise it will not be possible to control vehicle response. ◀

The tow fittings used should be on the same side on both vehicles. Should it prove impossible to avoid mounting the tow bar at an offset angle, please observe the following:

- ▷ Clearance and maneuvering capability will be strictly limited during cornering.

- ▶ When mounted at an angle, the tow bar will exert lateral forces, tending to push the vehicle sideways.

 Secure the tow bar to the tow fitting only. Otherwise to other vehicle parts could result. ◀

### With tow rope

When starting off in the towing vehicle, make sure that the tow rope is taut.

 To avoid jerking and the associated stresses on vehicle components when towing, always use nylon ropes or nylon straps. Secure the tow rope to the tow fitting only. Otherwise damage to other vehicle parts could result. ◀

### With tow truck

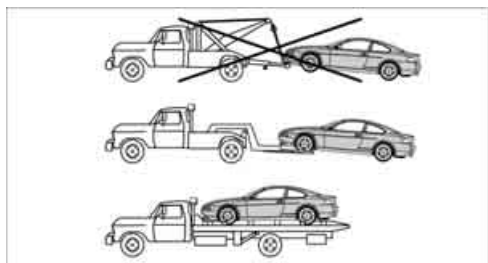

Have the BMW transported with a tow truck with a so-called lift bar or on a load bed.

 Do not lift vehicle by tow fitting or body and chassis parts, as otherwise damage may result. ◀

### Tow-starting

 Do not tow-start vehicles with an automatic transmission.

Jump starting, refer to page 186. ◀

Only tow-start vehicles with a catalytic converter with the engine cold. It is better to jump start the engine, refer to page 186.

1. Switch on the hazard warning flashers, comply with country-specific regulations.
2. Turn the ignition key to position 2.
3. Shift into 3rd gear, vehicles with SMG, see below.

4. Have the vehicle tow-started with the clutch pedal completely depressed and slowly release the clutch. After the engine starts, immediately depress the clutch pedal completely again.
5. Stop at a suitable location, remove the tow bar or rope and switch off the hazard warning flashers.
6. Have the vehicle checked.

Vehicles with SMG Sequential manual transmission:

1. Tow-start in selector lever position N.
2. Select sequential mode. The correct gear will be selected and engaged automatically.



## Reference

This chapter contains the technical data, the short commands of the voice command system and the index which helps you find the information you are searching for fastest.



# Technical data

## Engine specifications

		645Ci
Displacement	cu in/cm <sup>3</sup>	268.4/4,398
Number of cylinders		8
Maximum output	hp	325
at engine speed	rpm	6,100
Maximum torque	lb ft/Nm	330/450
at engine speed	rpm	3,600

## Weights

		645Ci Coupe	645Ci Convertible
Curb weight	lbs./kg		
with manual transmission		3,781/1,715	4,178/1,895
with automatic transmission/SMG		3,792/1,720	4,189/1,900
Approved gross weight	lbs./kg		
with manual transmission		4,619/2,095	4,960/2,250
with automatic transmission/SMG		4,630/2,100	4,971/2,255
Load	lbs./kg	838/380	772/350
Approved front axle load	lbs./kg	2,271/1,030	2,381/1,080
Approved rear axle load	lbs./kg	2,513/1,140	2,778/1,260
Luggage compartment capacity	cu ft/l	15.9/450	10.6/300
Convertible: with convertible top compartment floor up, refer to page 34		–	12.4/350

Never exceed either the approved axle loads or the gross vehicle weight.

## Coupe: dimensions

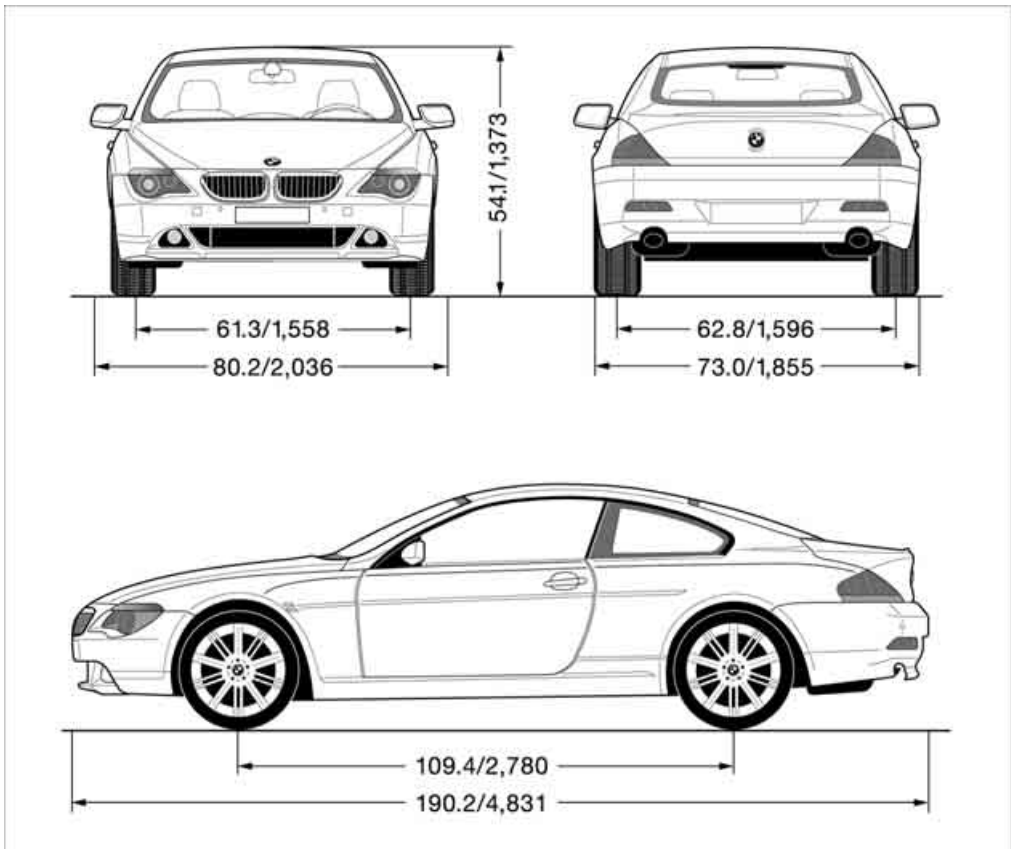

All dimensions in inches/mm. Minimum turning circle diameter: 37.4 ft/11.4 m

Convertible: dimensions

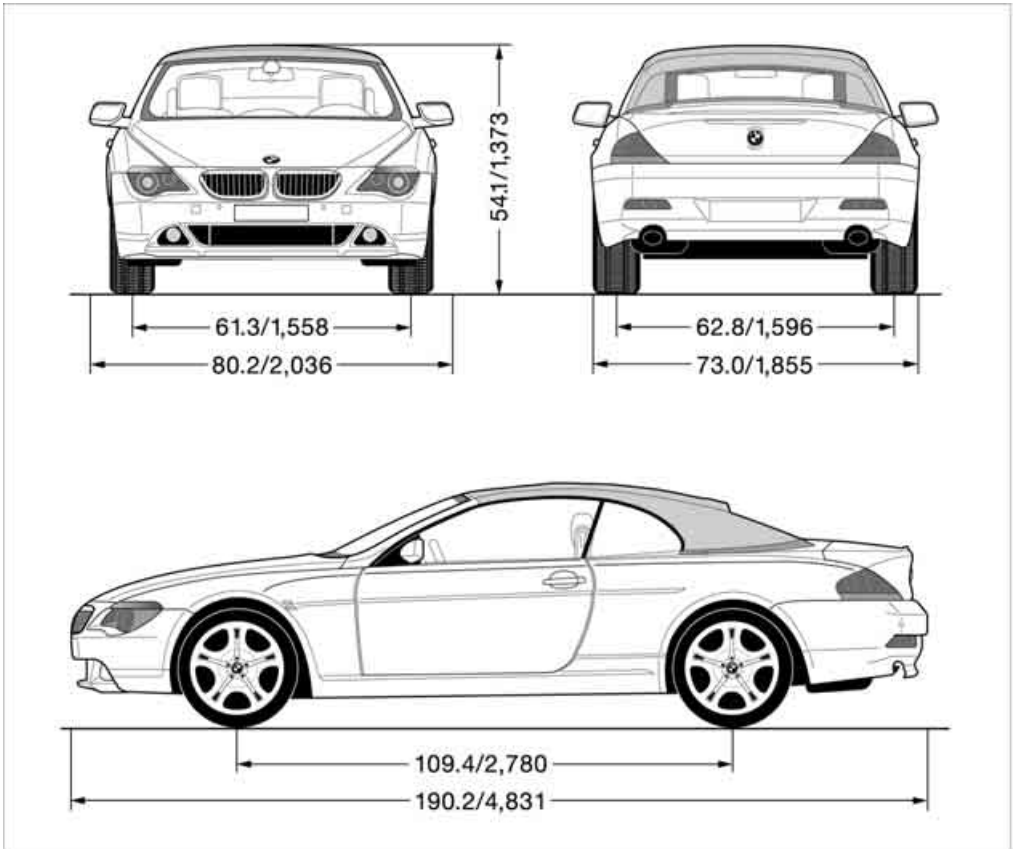

All dimensions in inches/mm. Minimum turning circle diameter: 37.4 ft/11.4 m

## Capacities

			Notes
Fuel tank	gal/liters	approx. 18.5/70	Fuel specification: page <a href="#">167</a>
Reserve	gal/liters	approx. 2.1/8	
Window and headlamp washer system	quarts/liters	approx. 5.3/5	For details: page <a href="#">61</a>
Engine oil and filter change	quarts/liters	8.5/8	BMW High Performance Synthetic Oil Oil grades: page <a href="#">176</a>

# Short commands of the voice command system\*

With short commands you can carry out certain functions directly, regardless of which menu

item is selected. Here are the important short commands for the voice command system.

## Communication

Function	Command
Activating the telephone 152	›Phone⟨
Dialing phone number 152	›Dial number⟨
Displaying the phone book 153	›A to Z⟨
Selecting from the phone book 153	›Call ...⟨ or ›Dial name⟨
Displaying "Top 8" 154	›Top 8⟨
Redialing 154	›Redial⟨
Displaying "Received calls" 154	›Received calls⟨
Displaying "Missed calls" 154	›Missed calls⟨
Displaying "SMS" 155	›SMS⟨
Displaying "Bluetooth" 155	›Bluetooth⟨
Opening BMW Assist 159	›BMW Assist⟨

## Navigation

Function	Command
Displaying the current position 125	›Current position⟨
Opening the destination entry 115	›Enter address⟨ or ›New destination⟨
Displaying "Input map" 117	›Input map⟨
Opening "Information" 118	›Information menu⟨
Displaying the address book 120	›Address book⟨ or ›From address book⟨
Displaying the route criteria 122	›Route preference⟨
Displaying arrow view 127	›Arrow display⟨
Displaying route map 127	›Map⟨ ›Map facing north⟨ or ›Map direction of travel⟨

Function	Command
Changing scale <a href="#">127</a>	›Scale ... kilometers‹ or ›Scale ... meters‹
Displaying streets and towns/cities of the route <a href="#">127</a>	›Route list‹

## Onboard information

Function	Command
Displaying the computer <a href="#">75</a>	›Onboard info‹
Displaying the trip computer <a href="#">75</a>	›Trip computer‹
Setting speed limit <a href="#">76</a>	›Limit‹
Starting the stopwatch <a href="#">77</a>	›Stopwatch‹

## Entertainment

Function	Command
Switching on radio <a href="#">136</a>	›Radio on‹
Opening "FM" <a href="#">136</a>	›FM menu‹
Opening "AM" <a href="#">136</a>	›AM menu‹
Selecting the radio station <a href="#">136</a>	›Station‹ name
Opening "Presets" <a href="#">136</a>	›FM presets‹ or ›AM presets‹
Selecting stored stations <a href="#">136</a>	›Station ...‹
Opening "Manual" <a href="#">137</a>	›FM manual‹ or ›AM manual‹
Opening the radio station with the best reception <a href="#">138</a>	›AM Autostore‹
Opening "CD" <a href="#">143</a>	›CD menu‹
Selecting a CD <a href="#">143</a>	›CD 1...6‹
Selecting a track <a href="#">144</a>	›Track ...‹

## Climate

Function	Command
Opening "Vent settings" <a href="#">96</a>	›Vent settings‹
Opening "Automatic programs" <a href="#">97</a>	›Automatic programs‹
Opening "Parked car operation" <a href="#">98</a>	›Parked car operation‹
Opening "Automatic ventilation" <a href="#">98</a>	›Automatic ventilation‹
Displaying the activation times <a href="#">98</a>	›Activation time‹

## i menu

Function	Command
Opening "Door locks" <a href="#">29, 31</a>	›Door locks‹
Opening "Steering wheel buttons" <a href="#">51</a>	›Steering wheel buttons‹
Opening "Light" <a href="#">60, 91</a>	›Light‹
Opening "Communication settings" <a href="#">159</a>	›Communication settings‹
Opening "BMW Service settings" <a href="#">159</a>	›BMW Service settings‹
Opening "BMW Service" <a href="#">161</a>	›BMW Service‹
Opening "Service requirements" <a href="#">70, 160</a>	›Service requirements‹
Opening "Service" <a href="#">70, 160</a>	›Service‹
Displaying "Check Control messages" <a href="#">73</a>	›Check Control messages‹
Opening "Display settings" <a href="#">77</a>	›Display settings‹
Opening "Head-Up Display selection" <a href="#">89</a>	›HUD configurations‹
Adjusting the brightness of the Control Display <a href="#">77</a>	›Brightness‹
Opening "Units" <a href="#">77</a>	›Units‹
Opening "Languages" <a href="#">78, 126</a>	›Language‹
Opening "Time" <a href="#">78</a>	›Time‹
Opening "Date" <a href="#">78</a>	›Date‹
Opening "PDC" <a href="#">80</a>	›PDC‹
Opening "FTM" <a href="#">84</a>	›FTM‹
Opening "Entertainment settings" <a href="#">133</a>	›Entertainment settings‹

## Index

"..." Identifies Control Display texts used to select individual functions, pointing out where these are located.

### A

ABS Antilock Brake System **81**

– indicator lamp **83**

– malfunction **83**

ACC, refer to Active cruise control **62**

Acceleration assistant with SMG **59**

Accessories, refer to Your individual vehicle **5**

Activated-charcoal filter **97**

"Activation time" for independent ventilation **98**

Active cruise control **62**

– indicator lamps **64**

– malfunction **68**

– selecting distance **65**

Active roll stabilization **83**

Active steering **85**

– initializing system **86**

– warning lamp **85**

Adapting temperature in upper body region **97**

Adaptive brake lamps, refer to Brake Force Display **86**

Adaptive Head Light **92**

"Add digits" for portable phone **153**

"Address book" for navigation **120**

Address for navigation

– deleting **121**

– entering **115**

– selecting **120**

– storing current position **120**

"Add to destination list" **117**

Adhesive bandages, refer to First-aid kit **186**

Adjusting the temperature with automatic climate control **95**

Adjusting the thigh support **45**

Adjusting tone during audio operation, refer to Tone control **133**

"After opening door" **46**

"After unlocking" **46**

Airbags **86**

– deactivating, Coupe **52**

– sitting safely **44**

– warning lamp **87**

Air distribution

– automatic **95**

– manual **96**

Airing, refer to Ventilation **97**

Air recirculation, refer to AUC Automatic recirculated-air control **95**

"Air recirculation on / off" **51**

Air vents, refer to Ventilation **94**

Air volume **95**

AKI, refer to Fuel specifications **167**

Alarm system **34**

– avoiding unintentional alarms **35**

– interior motion sensor **35**

– switching off alarm **34**

– switching off tilt alarm sensor and interior motion sensor **35**

– tilt alarm sensor **35**

All around the center console **14**

All around the steering wheel **10**

"All channels" **141**

"All doors" **29**

All-season tires, refer to Winter tires **172**

"AM", reception range **133, 136**

Antenna for portable phone **150**

Antifreeze

– coolant **176**

– washer fluid **61**

Antilock Brake System ABS **81**

– indicator lamp **83**

Anti-theft alarm system, refer to Alarm system **34**

Anti-theft system **29**

Anti-trapping mechanism

– glass sunroof **38**

– power windows **37**

Approved axle loads, refer to Weights **192**

Approved gross vehicle weight, refer to Weights **192**

Armrest, refer to Center armrest **102**

Arrival time

– refer to Computer **75**

– refer to Starting destination guidance **124**

"Arrow display" during Navigation **127**

Ashtray **103**

Assist, refer to BMW Assist **159**

Assistance systems, refer to Driving stability control systems **81**

Assistance window **20**

"Assist. window off" **21**

AUC Automatic recirculated-air control **95**

"Audio" **133**



- Audio [132](#)
    - controls [132](#)
    - switching on/off [132](#)
    - tone control [133](#)
    - volume [133](#)
  - Automatic
    - air distribution [95](#)
    - air volume [95](#)
    - cruise control [61](#), [62](#)
    - headlamp control [91](#)
    - service notification [160](#)
    - steering wheel adjustment, refer to [Easy entry/exit 50](#)
    - storing stations [138](#)
  - Automatic car washes [110](#)
    - also refer to the [Caring for your vehicle brochure](#)
  - Automatic climate control [94](#)
    - automatic air distribution [95](#)
    - convertible program [97](#)
    - settings using Control Center [96](#)
    - switching off [96](#)
  - Automatic curb monitor [47](#)
  - "Automatic programs" [97](#)
  - Automatic recirculated-air control AUC [95](#)
  - Automatic station search [137](#)
  - Automatic transmission with Steptronic [58](#)
    - convenience start [55](#)
    - Dynamic Driving Control [59](#)
    - interlock [54](#)
    - kick-down [58](#)
    - selector lever interlock [58](#)
    - shiftlock [58](#)
    - starting engine [55](#)
    - towing [188](#)
    - tow-starting [189](#)
  - "Automatic ventilation" [98](#)
  - AUTO program with automatic climate control [95](#)
  - "Autostore" on the radio [136](#), [138](#)
  - Average fuel consumption [74](#)
    - setting units [77](#)
  - Average speed [74](#)
  - "Avoid ferries" for navigation [123](#)
  - Avoid freeways for navigation [122](#)
  - "Avoid highways" for navigation [122](#)
  - Avoiding unintentional alarms [35](#)
  - "Avoid tollroads" for navigation [123](#)
  - Axle loads, refer to [Weights 192](#)
  - "A - Z" [153](#)
- B**
- Backrests, refer to [Seats 44](#)
  - Backup lamps, refer to [Reverse gear 56](#)
  - Balance, refer to [Tone control 134](#)
  - Balance adjustment in audio mode, right/left [134](#)
  - Bandages, refer to [First-aid kit 186](#)
  - "Bass", refer to [Tone control 134](#)
  - Bass, refer to [Tone control 133](#)
  - Battery
    - jump starting [186](#)
    - refer to [Vehicle battery 183](#)
  - Being towed [188](#)
  - Belts, refer to [Safety belts 48](#)
  - Beverage holder, refer to [Cup holders 103](#)
  - Black ice, refer to [Ice warning 69](#)
  - Blower, refer to [Air volume 95](#)
  - BMW Assist [159](#)
    - enabling [159](#)
    - services offered [160](#)
  - BMW maintenance system [178](#)
  - "BMW Service" [161](#)
  - "BMW Service settings" [159](#)
  - Bottle holder, refer to [Cup holders 103](#)
  - Brake Assistant, refer to [DBC Dynamic Brake Control 81](#)
  - Brake fluid [177](#)
    - warning lamp [177](#)
  - Brake Force Display [86](#)
  - Brake hydraulic system [177](#)
  - Brake lamps
    - Brake Force Display [86](#)
    - replacing bulbs [182](#)
  - Brake pads [177](#)
    - breaking-in [108](#)
  - Brake rotors [110](#)
  - Brakes [109](#)
    - ABS Antilock Brake System [81](#)
    - brake fluid [177](#)
    - Brake Force Display [86](#)
    - brake pads [108](#), [177](#)
    - breaking-in [108](#)
    - CBC Cornering Brake Control [81](#)
    - handbrake [55](#)
  - Brake system [108](#)
    - brake fluid level [177](#)
    - brake pads [108](#), [177](#)
    - brake rotors [110](#)
    - breaking-in [108](#)
    - warning lamp [13](#), [83](#), [177](#)
  - Brake wear warning
    - brake pads [177](#)
  - Braking
    - electronic brake-force distribution [81](#)
    - refer to [Braking safely 109](#)
  - Breakdown assistance [161](#)
  - Breakdown services, refer to [Roadside Assistance 186](#)
  - Breaking-in [108](#)
    - clutch [108](#)
    - differential [108](#)
  - Break wear warning
    - warning lamp [177](#)
  - "Brightness" [77](#)
  - Buttons on steering wheel [11](#)
  - Bypassing route sections [128](#)

## C

California law

– Event Data Recorders [179](#)

California Proposition 65

Warning [6](#)

"Call" [153](#)

Call

– accepting [152](#)

– display accepted [153](#)

– ending [152](#)

– in absence [153](#)

– starting [152](#)

Calling

– from phone book [153](#)

– from the Top 8 list [153](#)

– redialing [153](#)

"Call sender" [156](#)

Can holder, refer to Cup holders [103](#)

Capacities [195](#)

Capacity of the luggage compartment [192](#)

Car battery, refer to Vehicle battery [183](#)

Car care, refer to the Caring for your vehicle brochure

Car-care products, refer to the Caring for your vehicle brochure

"Car data" [74](#)

Care, refer to the Caring for your vehicle brochure

Cargo loading

– securing cargo [111](#)

– stowing cargo [111](#)

– vehicle [110](#)

Caring for artificial leather, refer to the Caring for your vehicle brochure

Caring for leather, refer to the Caring for your vehicle brochure

Caring for light-alloy wheels, refer to the Caring for your vehicle brochure

Caring for plastic, refer to the Caring for your vehicle brochure

Caring for the carpet, refer to the Caring for your vehicle brochure

Caring for the vehicle finish, refer to the Caring for your vehicle brochure

Car keys, refer to Key set [28](#)

Car phone [151](#)

– installation location, refer to Center armrest [102](#)

– refer to Portable phone [150](#)

– refer to separate Owner's Manual

Car radio, refer to Radio [136](#)

Car wash [110](#)

– also refer to the Caring for your vehicle brochure

– refer to Before driving into a car wash [110](#)

Catalytic converter, refer to Hot exhaust system [108](#)

"Categories" [141](#)

CBC Cornering Brake Control [81](#)

CBS Condition Based Service [178](#)

"CD" [133](#), [143](#)

CD changer [143](#)

– controls [132](#)

– fast forward/reverse [145](#)

– installation location [145](#)

– playing a track [145](#)

– random play sequence [145](#)

– repeating a track [144](#)

– selecting a CD [144](#)

– selecting a track [144](#)

– switching on/off [132](#)

– tone control [133](#)

– volume [133](#)

CD player [143](#)

– controls [132](#)

– fast forward/reverse [145](#)

– playing a track [145](#)

– random play sequence [145](#)

– repeating a track [144](#)

– selecting a track [144](#)

– switching on/off [132](#)

– tone control [133](#)

– volume [133](#)

Center armrest

– adjusting the height [102](#)

– front [102](#)

Center console [14](#)

"Central locking" [29](#)

Central locking system [29](#)

– from inside vehicle [31](#)

Changes, technical, refer to

For your own safety [6](#)

Changing a wheel [183](#)

Changing gear

– automatic transmission with Steptronic [58](#)

Changing language on

Control Display [78](#)

Changing measurement units on Control Display [77](#)

Changing wheels [183](#)

CHECK button [73](#)

Check Control [71](#)

"Check Control messages" [73](#)

Check Gas Cap [166](#)

Checking the air pressure, refer to Tire inflation pressure [168](#)

Child's seats, refer to Child-restraint systems [52](#)

Child-restraint fixing system LATCH [53](#)

Child restraints [52](#)

Child-restraint systems [52](#)

Chrome parts, care, refer to the Caring for your vehicle brochure

Cigarette lighter [103](#)

Cleaning, refer to the Caring for your vehicle brochure

Cleaning the windshield, refer to Wiper system [61](#)

"Climate" [96](#)

Clock [69](#)

– 12h/24h mode [78](#)

– setting time and date [78](#)

Closing

– from inside [31](#)

– from outside [29](#)

Clothes hooks, Coupe [102](#)

Cockpit [10](#)

Cold start, refer to Starting engine [54](#)

"Communication" [152](#)

"Communication settings" [159](#)

Compact disc

– refer to CD changer [143](#)

– refer to CD player [143](#)

Computer [74](#)

– clock, 12h/24h clock mode [78](#)

– displays on Control Display [74](#)

– hour signal [78](#)

"Concert hall" [135](#)

Condition Based Service CBS [178](#)

"Confirmation" [30](#)

Confirmation signals for locking and unlocking [30](#)

Connecting a vacuum cleaner, refer to Socket [103](#)

Consumption display, refer to Average fuel consumption [74](#)

"Continue guidance to destination?" [125](#)

Control Center [16](#)

– adjusting brightness [77](#)

– assistance window [20](#)

– automatic climate control [96](#)

– changing settings [19](#), [77](#)

– changing the menu page [19](#)

– changing time and date [78](#)

– confirming selection or entry [19](#)

– controller [16](#)

– display, menus [16](#)

– language selection [78](#)

– menu item selection [19](#)

– menu navigation [17](#)

– operating elements [16](#)

– selecting units of measurement and display format [77](#)

– start menu [17](#)

– status information [20](#)

– symbols [17](#)

Control Display [16](#)

Controller, refer to Control Center [16](#)

Controls, refer to Cockpit [10](#)

Convenience operation

– convertible top [30](#), [31](#)

– glass sunroof [30](#), [31](#)

– windows [30](#), [31](#)

Convenience start, refer to

Starting engine [54](#), [55](#)

Convertible

– convertible program for automatic climate control [97](#)

– opening and closing windows [36](#)

– rollover protection

system [87](#)

– top [39](#)

– wind deflector [42](#)

Convertible top

– care, refer to the Caring for your vehicle brochure

– convenience operation [31](#)

– emergency closing [41](#)

– manual closing in the event of an electrical malfunction [41](#)

– opening and closing [40](#)

Coolant [176](#)

– level [176](#)

Cooling, maximum [95](#)

Cornering Brake Control CBC [81](#)

Country of destination for navigation [116](#)

Courtesy lighting [93](#)

Cruise control [61](#)

– active cruise control [62](#)

Cruising range [74](#)

Cup holders [103](#)

Curb weight, refer to

Weights [192](#)

"Current position" [125](#)

Current position

– displaying [125](#)

– entering [120](#)

– storing [120](#)

"Customer Relations" [162](#)

Cylinders, refer to Engine data [192](#)

## D

Dashboard, refer to Cockpit [10](#)

Dashboard lighting, refer to Instrument lighting [93](#)

Data [192](#)

– capacities [195](#)

– dimensions [193](#)

– engine [192](#)

– weights [192](#)

"Date" [79](#)

Date [69](#)

– setting [78](#)

"Date format" [79](#)

Daytime driving lamps [91](#)

DBC Dynamic Brake

Control [81](#)

– malfunction [83](#)

– warning lamp [83](#)

"Deactivated" [47](#)

Deactivating front passenger airbag, Coupe [52](#)

Decommissioning the vehicle, refer to the Caring for your vehicle brochure

Deep water, refer to Driving through water [109](#)

Defrosting windows [95](#)

Defrosting windows and

removing condensation [95](#)

Defrosting windshield, refer to Defrosting windows [95](#)

Defrost position, refer to Defrosting windows [95](#)

"Delete address book" for navigation [121](#)

"Delete all numbers" on the portable phone [155](#)

"Delete data" for navigation [121](#)

"Delete" for portable phone [154](#)

Destination address

– deleting [121](#)

– entering [115](#)

Destination for navigation

- destination list [119](#)
- entry [115](#)
- home address [122](#)
- selecting from address book [120](#)
- selecting using information [118](#)
- storing [120](#)
- Destination guidance [124](#)
- bypassing route sections [128](#)
- canceling voice instructions [51](#)
- changing specified route [122](#)
- displaying route [127](#)
- distance and arrival [124](#)
- interrupting [125](#)
- starting [124](#)
- terminating/continuing [125](#)
- voice instructions [126](#)
- volume of voice instructions [126](#)
- Destination list [119](#)
- Destinations recently driven to [119](#)
- "Dial" for portable phone [152](#)
- "Dial number" [152](#)
- "Diamond button" [51](#)
- Digital clock [69](#)
- Dimensions
- Convertible [194](#)
- Coupe [193](#)
- Dipstick for engine oil [175](#)
- Directional indicators, refer to Turn signals [60](#)
- Direction announcements, refer to Voice instructions [126](#)
- Direction instructions, refer to Voice instructions [126](#)
- Directory, refer to Phone book [153](#)
- Directory for navigation, refer to Address book [120](#)
- Disc brakes [109](#)

- Displacement, refer to Engine data [192](#)
- Display, refer to Control Center [16](#)
- "Display off" [21](#)
- Displays, refer to Instrument cluster [12](#)
- "Display settings" [77](#)
- Displays on the windshield, refer to Head-Up Display [88](#)
- Disposal, vehicle battery [183](#)
- Distance, refer to Computer [75](#)
- Distance control, refer to Active cruise control [62](#)
- "Distance to dest." [75](#)
- Distance to destination, refer to Computer [75](#)
- Distance warning, refer to PDC Park Distance Control [80](#)
- Door entry lighting [93](#)
- Door keys [28](#)
- Door lock [31](#)
- "Door locks" [29](#)
- Doors
- manual operation [31](#)
- remote control [30](#)
- DOT Quality Grades [170](#)
- Draft-free ventilation [97](#)
- "Driver's door only" [29](#)
- Driving lamps, refer to Parking lamps/low beams [91](#)
- Driving notes [108](#)
- Driving route, refer to Displaying the route [127](#)
- Driving stability control systems [82](#)
- Driving through water [109](#)
- Driving tips, refer to Driving notes [108](#)
- Drying the air, refer to Cooling function [95](#)
- DSC Dynamic Stability Control [82](#)
- indicator lamp [13, 83](#)
- malfunction [83](#)

- DTC Dynamic Traction Control [82](#)
- activating [82](#)
- indicator lamp [13, 82](#)
- DVD for navigation [114](#)
- Dynamic Brake Control DBC [81](#)
- Dynamic Driving Control [59](#)
- "Dynamic route" for navigation [122](#)
- Dynamic Stability Control DSC [82](#)
- indicator lamp [13, 83](#)
- Dynamic Traction Control DTC [82](#)
- indicator lamp [13](#)

## E

- Easy entry, refer to Entry to the rear [48](#)
- Easy entry/exit [50](#)
- EBV, refer to Electronic brake-force distribution [81](#)
- "Edit address" for navigation [121](#)
- Eject button, refer to Buttons on CD player [132](#)
- Electrical malfunction
- convertible top [41](#)
- door lock [31](#)
- driver's door [31](#)
- fuel filler door [166](#)
- glass sunroof [38](#)
- luggage compartment lid [33](#)
- storage compartment, hotel function [32](#)
- Electric steering wheel adjustment [50](#)
- Electronic brake-force distribution [81](#)
- Emergency Assistance, refer to Roadside Assistance [186](#)
- Emergency call [185](#)

- Emergency operation, refer to
    - Manual operation
    - convertible top [41](#)
    - door lock [31](#)
    - driver's door [31](#)
    - fuel filler door [166](#)
    - glass sunroof [38](#)
    - luggage compartment lid [32](#), [33](#)
  - Emergency release [33](#)
  - Emergency services, refer to
    - Roadside Assistance [186](#)
  - "Emission inspect." [71](#)
  - "Enable services" [160](#)
  - "End call" [153](#)
  - Engine
    - breaking-in [108](#)
    - data [192](#)
    - speed [192](#)
    - starting [54](#)
    - starting difficulties [54](#)
    - switching off [55](#)
  - Engine compartment [175](#)
  - Engine coolant [176](#)
  - Engine oil
    - checking the oil level [175](#)
    - dipstick [175](#)
    - specified engine oils [176](#)
    - temperature [70](#)
    - temperature gauge [70](#)
    - topping off [176](#)
  - Engine output, refer to Engine data [192](#)
  - Engine speed, refer to Engine specifications [192](#)
  - Engine starting, refer to
    - Starting engine [54](#)
  - "Enter address" for navigation [116](#)
  - Entering destination [116](#)
  - Entering the address [115](#)
  - Entering the intersection [117](#)
  - Entering the town/city for navigation [116](#)
  - Entering zip code for navigation [116](#)
  - "Entertainment" [133](#)
  - "Entertainment settings" [133](#)
  - Entry map for destination [117](#)
  - Entry to the rear [48](#)
  - "Equalizer", refer to Tone control [135](#)
  - "ESN" [140](#)
  - ESP Electronic Stability Program, refer to DSC Dynamic Stability Control [82](#)
  - Exhaust system, refer to Hot exhaust system [108](#)
  - Exterior mirrors [49](#)
    - automatic dimming feature [50](#)
    - automatic heating [50](#)
  - Eye for towing, refer to Tow fitting [188](#)
  - Eyes for lashing, refer to
    - Securing load [111](#)
- ## F
- Fader, refer to Tone control [134](#)
  - Failure messages, refer to
    - Check Control [71](#)
  - False alarms, refer to Avoiding unintentional alarms [35](#)
  - Fastening safety belts, refer to
    - Safety belts [48](#)
  - Fastest route for navigation [122](#)
  - Fast forward
    - CD changer [145](#)
    - CD player [145](#)
  - "Fast route" for navigation [122](#)
  - First aid, refer to First-aid kit [186](#)
  - First-aid kit [186](#)
  - First-aid pouch, refer to First-aid kit [186](#)
  - Flashing when locking and unlocking, refer to Setting acknowledgement signals [30](#)
  - Flashlight, refer to
    - Rechargeable flashlight [101](#)
  - Flat tire
    - Flat Tire Monitor [84](#)
    - run-flat tires [85](#), [172](#)
  - Flat Tire Monitor [84](#)
    - false alarms [84](#)
    - initializing system [84](#)
    - malfunction [85](#)
    - snow chains [173](#)
    - system limits [84](#)
    - warning lamp [85](#)
  - "FM", reception range [133](#), [136](#)
  - FM, waveband [136](#)
  - Fog lamps [92](#)
    - indicator lamp [13](#), [92](#)
  - Folding up convertible top compartment floor,
    - Convertible [34](#)
  - Footbrake, refer to Braking safely [109](#)
  - Footwell lamps [93](#)
  - For your own safety [6](#)
  - Front airbags [86](#)
  - Front head restraints [47](#)
  - "FTM" [84](#)
  - Fuel
    - average consumption [74](#)
    - display [70](#)
    - fuel specifications [167](#)
    - high-quality brands [167](#)
    - quality [167](#)
    - tank capacity [166](#)
  - Fuel display, refer to Fuel gauge [70](#)
  - Fuel filler door [166](#)
    - releasing in the event of electrical malfunction [166](#)
  - Fuel gauge [70](#)
  - Fuel specifications [167](#)
  - Fuses [184](#)

## G

- Garage-door opener, refer to Integrated universal remote control [100](#)
- Gasoline
  - refer to Fuel specifications [167](#)
  - refer to Required fuel [167](#)
- Gasoline display, refer to Fuel gage [70](#)
- Gear changes
  - SMG Sequential manual transmission [57](#)
- Gear display
  - automatic transmission with Steptronic [58](#)
  - SMG Sequential manual transmission [57](#)
- Gearshift lever
  - automatic transmission with Steptronic [58](#)
  - manual transmission [56](#)
  - SMG Sequential manual transmission [56](#)
- General driving notes [108](#)
- Glass sunroof, electric with raise function [37](#)
  - convenience operation [31](#)
  - moving manually [38](#)
  - remote control [30](#)
- Glove compartment [101](#)
  - rechargeable flashlight [101](#)
- GPS navigation, refer to Navigation system [114](#)
- Grills, refer to Ventilation [94](#)
- Gross vehicle weight, refer to Weights [192](#)

## H

- Handbrake [55](#)
  - indicator lamp [13, 55](#)
- Hands-free system [14, 151](#)
- Hazard warning flashers [15](#)
- Head airbags [86](#)
- Headlamp control, automatic [91](#)
- Headlamp flasher [60](#)
- Headlamps
  - care, refer to the Caring for your vehicle brochure
  - cleaning, refer to Wiper system [61](#)
  - replacing bulbs [180](#)
- Head Light, refer to Adaptive Head Light [92](#)
- Head-Up Display [88](#)
- Heated mirrors [50](#)
- Heated rear window [94](#)
- Heated seats [49](#)
- Heated steering wheel [51](#)
- Heater [95](#)
- Heating
  - exterior mirrors [50](#)
  - interior [94](#)
  - rear window [94](#)
  - residual heat mode [96](#)
  - seats [49](#)
  - steering wheel [51](#)
- Heating with engine switched off, refer to Residual heat mode [96](#)
- Heavy cargo, refer to Securing load [111](#)
- Height, refer to Dimensions [193](#)
- Height adjustment
  - seats [45](#)
  - steering wheel [50](#)
- High beams [92](#)
  - headlamp flasher [92](#)
  - indicator lamp [13](#)
  - replacing bulbs [180](#)
- Hills [109](#)
- Holder for cups [103](#)
- "Home address" [122](#)
- Hood [174](#)
- Horn [10](#)
- Hotel function [32](#)
- Hot exhaust system [108](#)
- "Hour memo" [78](#)
- "House number" for destination entry [117](#)

- Hydraulic Brake Assistant, refer to DBC Dynamic Brake Control [81](#)
- Hydroplaning [109](#)
  - also refer to Minimum tread depth [171](#)

## I

- Ice warning [69](#)
- iDrive, refer to Control Center [16](#)
- Ignition key [28](#)
- Ignition key positions, refer to Ignition lock [54](#)
- Ignition lock [54](#)
- Increasing luggage compartment capacity, Convertible [34](#)
- Independent ventilation
  - activating an activation time [98](#)
  - setting activation time [98](#)
  - switching on and off directly [98](#)
- Indicator/warning lamps
  - ABS Antilock Brake System [83](#)
  - active steering [85](#)
  - airbags [87](#)
  - brake system [13, 83](#)
  - DSC Dynamic Stability Control [13, 83](#)
  - DTC Dynamic Traction Control [13, 82](#)
  - fastening safety belts [49](#)
  - Flat Tire Monitor [85](#)
  - fog lamps [13, 92](#)
  - handbrake [55](#)
- Indicator and warning lamps, overview [13](#)
- Individually assignable buttons on steering wheel, refer to Programmable buttons on steering wheel [51](#)
- Individual settings, refer to Key Memory [28](#)

Inflation pressure, refer to Tire inflation pressure **168**

Inflation pressure monitoring, refer to Flat Tire Monitor **84**

Information

- on another location **118**
- on current position **118**
- on destination location **118**

"Information" for navigation **118**

"Information on destination" **119**

Initializing, refer to Power failure **184**

"Input map" **118**

Inside rearview mirror, automatically dimming, refer to Automatic functions **50**

Installation location

- CD changer **145**
- navigation drive **114**

Instructions for navigation system, refer to Voice instructions **126**

Instrument cluster **12**

Instrument illumination, refer to Instrument lighting **93**

Instrument lighting **93**

Instrument panel, refer to Instrument cluster **12**

Integrated universal remote control **100**

Interesting destination **118**

"Interim time" **77**

Interior lamps **93**

- remote control **30**

Interlock, refer to Steering locked **54**

Interlock on automatic transmission **54**

Intermittent mode of the wipers **60**

## J

Jacking points **183**

Joystick, refer to Control Center **16**

Jumping, refer to Jump starting **186**

Jumping, refer to Jump starting **186**

Jump starting **186**

## K

Key Memory **28**

"Keypad" **155**

Keys **28**

Kick-down

- automatic transmission with Steptronic **58**
- SMG Sequential manual transmission **57**

Knock control **167**

## L

Lamps, refer to Parking lamps/ low beams **91**

Lamps and bulbs **180**

"Languages" **78**

"Languages" for navigation **126**

Lashing eyes, refer to Securing load **111**

Last destinations, refer to Destination list **119**

"Last seat pos." **46**

LATCH child-restraint fixing system **53**

LEDs Light-emitting diodes **183**

Length, refer to Dimensions **193**

Letter symbol with portable phone **155**

License plate lamps, replacing bulbs **182**

"Light" **60, 91**

Light-emitting diodes LEDs **183**

Lighter **103**

Lighter socket **103**

Lighting

- instruments **93**
- of the vehicle, refer to Lamps **91**

Lights on warning **91**

Light switch **91**

"Limit" **76**

"Lock after driving" **32**

Lock buttons in the doors, refer to Locking **32**

Locking

- from inside **32**
- from outside **30**

Locking and unlocking doors

- from inside **31**
- from outside **29**

"LOGIC7", refer to Tone control **134**

Low beams **91**

- automatic **91**
- replacing bulbs **180**

Lower back support, refer to Lumbar support **45**

Luggage compartment

- capacity **192**
- emergency release **33**
- hotel function **32**
- increasing capacity, Convertible **34**
- opening/closing, refer to Luggage compartment lid **33**
- opening from inside **33**
- opening from outside **33**
- opening with remote control **30**

Luggage compartment lid **32**

- emergency operation **33**
- emergency release **33**
- opening from inside **33**
- opening from outside **33**
- opening with remote control **30**
- unlocking manually **33**

Lumbar support **45**

LW, waveband **136**

## M

- M+S tires, refer to Winter tires [172](#)
- Maintenance, refer to the Service and Warranty Information Booklet for US models or to the Warranty and Service Guide Booklet for Canadian models [178](#)
- Maintenance system [178](#)
- Malfunction
  - convertible top [41](#)
  - door lock [31](#)
  - fuel filler door [166](#)
  - glass sunroof [38](#)
  - luggage compartment lid [32, 33](#)
- Malfunction warnings, refer to Check Control [71](#)
- Manual air distribution [96](#)
- Manual mode with automatic transmission with Steptronic [58](#)
- "Manual" on the radio [137](#)
- Manual operation
  - convertible top [41](#)
  - door lock [31](#)
  - driver's door [31](#)
  - fuel filler door [166](#)
  - glass sunroof [38](#)
  - luggage compartment lid [32, 33](#)
- Manual transmission [56](#)
- Map
  - changing scale [127](#)
  - destination entry [117](#)
- "Map, direction of travel" [127](#)
- "Map, facing north" [127](#)
- Map facing north [127](#)
- Master key with remote control [28](#)
- Maximum cooling [95](#)
- Maximum speed with winter tires [173](#)

## Memory

- refer to Key Memory [28](#)
  - refer to Seat, mirror and steering wheel memory [46](#)
- Menus, refer to Control Center [16](#)
- Microfilter [97](#)
- Microphone
  - for hands-free system [151](#)
  - for portable phone [14](#)
  - for voice command system [14](#)
- Mirror dimming feature [50](#)
- Mirrors [49](#)
  - automatic curb monitor [47](#)
  - heating [50](#)
  - memory, refer to Seat, mirror and steering wheel memory [46](#)
- "Missed calls" [154](#)
- Missed calls [153](#)
- Mobile communication devices in vehicle [109](#)
- Mobile Service, refer to Roadside Assistance [186](#)
- Monitor, refer to Control Center [16](#)
- "Monitor display on" [81](#)
- "Monitor on / off" [51](#)
- Most recent portable phone numbers [153](#)
- Multi-function steering wheel, refer to Buttons on the steering wheel [11](#)
- Multifunction switch
  - refer to Turn signals/headlamp flasher [60](#)
  - refer to Wiper/washer system [60](#)
- Music track, finding [145](#)
- "Mute on / off" [51](#)
- MW, waveband [136](#)

## N

- "Navigation" [115](#)
- Navigation destination
  - manual entry [115](#)
  - selecting via map [117](#)
- Navigation drive, installation location [114](#)
- Navigation DVD [114](#)
- Navigation system [114](#)
  - address book [120](#)
  - bypassing route sections [128](#)
  - destination entry [115](#)
  - destination guidance in assistance window [114](#)
  - destination list [119](#)
  - displaying current position [125](#)
  - entering a destination manually [115](#)
  - looking for interesting destination [118](#)
  - navigation DVD [114](#)
  - route display [127](#)
  - route list [127](#)
  - selecting destination using information [118](#)
  - selecting destination via map [117](#)
  - selecting route criteria [122](#)
  - starting [115](#)
  - starting destination guidance [124](#)
  - switching off, refer to Terminating/continuing destination guidance [125](#)
  - terminating/continuing destination guidance [125](#)
  - voice instructions [126](#)
  - volume adjustment [126](#)
- "Navigation voice instructions on" [126](#)
- Neck support, refer to Front head restraints [47](#)
- "New address" for navigation [120](#)
- "New destination" [115, 117](#)



New keys [28](#)  
 "New route" [128](#)  
 New wheels and tires [172](#)  
 "Next entertainment source" [51](#)  
 Nozzles  
 – refer to Ventilation [94](#)  
 – refer to Windshield washer nozzles [61](#)  
 Nylon rope, refer to Towing and tow-starting [188](#)

## O

OBD Socket [179](#)  
 Octane ratings, refer to Fuel specifications [167](#)  
 Odometer [69](#)  
 Oil  
 – additives [176](#)  
 – capacity [195](#)  
 – dipstick [175](#)  
 – specified engine oils [176](#)  
 Oil change intervals  
 – refer to Service requirements [70](#)  
 – refer to the Service and Warranty Information Booklet for US models or to the Warranty and Service Guide Booklet for Canadian models [178](#)  
 Oil consumption [175](#)  
 Oil level [175](#)  
 Old batteries, refer to Disposal [183](#)  
 "On a new destination" for navigation [119](#)  
 Onboard computer, refer to Control Center [16](#)  
 "Onboard information" [75](#)  
 Onboard tool kit [180](#)  
 "On destination" [119](#)  
 "On location" [119](#)  
 Opening and closing  
 – from inside [31](#)  
 – from outside [29](#)  
 – using door lock [31](#)  
 – using the remote control [29](#)

Opening and closing rear window [37](#)  
 Operation by voice commands for portable phone [156](#)  
 – adjusting volume [157](#)  
 – canceling [156](#)  
 – correcting phone number [157](#)  
 – dialing a phone number [157](#)  
 – making a call [157](#)  
 – redialing [158](#)  
 – voice commands [156](#)  
 – voice phone book [157](#)  
 "Options" [162](#)  
 "Options" for portable phone [156](#)  
 Orientation menu, refer to Start menu [17](#)  
 Output, refer to Engine data [192](#)  
 Outside air, refer to AUC Automatic recirculated-air control [95](#)  
 Outside mirror  
 – tilting the passenger-side mirror [47](#)  
 Outside temperature display [69](#)  
 – changing unit of measurement [77](#)

## P

Panic mode [30](#)  
 Park Distance Control PDC [80](#)  
 "Parked car operation" [98](#)  
 Parking aid, refer to PDC Park Distance Control [80](#)  
 Parking brake, refer to Handbrake [55](#)  
 Parking lamps/low beams [91](#)  
 – replacing bulbs [180](#)  
 Parking vehicle [55](#)  
 Parts and accessories, refer to Your individual vehicle [5](#)  
 Passenger-side mirror tilt function [47](#)

"Pathway lighting" [91](#)  
 Pathway lighting [91](#)  
 "PDC" [81](#)  
 PDC Park Distance Control [80](#)  
 Phone book [151](#)  
 Phone numbers  
 – deleting in the phone book [154](#)  
 – dialing [152](#)  
 – most recent numbers [153](#)  
 – selecting in the phone book [153](#)  
 – Top 8 [153](#)  
 "Play" on the radio [141](#)  
 Pollen, refer to Microfilter/activated-charcoal filter [97](#)  
 Portable phone  
 – accepted calls [153](#)  
 – adjusting volume [151](#)  
 – calling [152](#)  
 – call termination [152](#)  
 – hands-free system [151](#), [157](#)  
 – missed calls [153](#)  
 – operation using Control Center [151](#)  
 – phone book [153](#)  
 – redialing [153](#)  
 – refer also to separate Owner's Manual  
 – SMS [155](#)  
 – Top 8 [153](#)  
 – touch tone dialing [155](#)  
 Portable phone battery [150](#)  
 Portable phones, use in vehicle, refer to Mobile communication devices in vehicle [109](#)  
 Position  
 – displaying [125](#)  
 – storing [120](#)  
 Power failure [184](#)  
 Power windows, refer to Windows [36](#)  
 "Presets" on the radio [136](#), [141](#)  
 Presetting independent ventilation activation times [98](#)  
 Pressure, tires [168](#)

Pressure monitoring of tires, refer to Flat Tire Monitor [84](#)  
Programmable buttons on steering wheel [51](#)  
Protective function, refer to Anti-trapping mechanism  
– glass sunroof [38](#)  
– windows [37](#)

## R

Radio  
– Autostore [138](#)  
– controls [132](#)  
– playing stations [137](#)  
– satellite radio [140](#)  
– selecting frequency manually [137](#)  
– selecting waveband [132](#), [136](#)  
– station search [137](#)  
– station selection [136](#)  
– station with best reception [138](#)  
– storing stations [138](#)  
– switching on/off [132](#)  
– tone control [133](#)  
– volume [133](#)  
– Weather Band [139](#)  
Radio-control key, refer to Master key with remote control [28](#)  
Rain sensor of the windshield washer system [61](#)  
"Random", random play sequence [145](#)  
Random play sequence  
– CD changer [145](#)  
– CD player [145](#)  
Reading lamps [93](#)  
Rear lamps, refer to Tail lamps [182](#)  
Rearview mirror [49](#)  
Rear window defroster [94](#)  
"Received calls" [154](#)  
Receiving level of portable phone, refer to Status information [20](#)

Reception  
– quality [139](#)  
– radio stations [139](#)  
– regional station [138](#)  
Rechargeable flashlight [101](#)  
Recirculated-air mode, refer to AUC Automatic recirculated-air control [95](#)  
Recirculation of air, refer to AUC Automatic recirculated-air control [95](#)  
Reclining seat, refer to Backrest [45](#)  
Recording times, refer to Stopwatch [77](#)  
"Redial" for portable phone [154](#)  
Redialing with portable phone [153](#)  
Refueling [166](#)  
Releasing hood [174](#)  
"Relock door if not opened" [32](#)  
Remaining distance  
– refer to Computer [75](#)  
– refer to Cruising range [74](#)  
Remote control [28](#)  
– garage-door opener [100](#)  
– luggage compartment lid [30](#)  
– malfunction [30](#)  
Removing condensation from windows [95](#)  
"Repeat" in audio mode [145](#)  
Replacement fuses [184](#)  
Replacement key, refer to New keys [28](#)  
Replacing bulbs, refer to Lamps and bulbs [180](#)  
Replacing tires  
– changing a wheel [183](#)  
– new wheels and tires [172](#)  
Reporting an accident, refer to Initiating emergency call [185](#)  
Reporting safety defects [7](#)  
Reserve warning, refer to Fuel gage [70](#)  
"Reset" for stopwatch [77](#)  
"Reset" in audio mode [135](#)

Residual heat mode [96](#)  
Restraint systems  
– for children [52](#)  
– refer to Safety belts [48](#)  
Retreaded tires [172](#)  
Reverse, fast  
– CD changer [145](#)  
– CD player [145](#)  
Reverse gear  
– automatic transmission with Steptronic [58](#)  
– manual transmission [56](#)  
– SMG Sequential manual transmission [57](#)  
Road map [127](#)  
"Roadside Assistance" [161](#)  
Roadside Assistance [186](#)  
Roadside parking lamps [92](#)  
– replacing bulbs [182](#)  
Rollover protection system on convertible [87](#)  
– lowering [87](#)  
Rope, refer to Towing and tow-starting [188](#)  
Rotary pushbutton, refer to Control Center [16](#)  
Route [122](#)  
– bypassing sections [128](#)  
– changing [122](#), [128](#)  
– display [127](#)  
– displaying arrow view [127](#)  
– displaying map [127](#)  
– displaying towns/cities and streets [127](#)  
– list [127](#)  
– selecting [122](#)  
– selecting criteria [122](#)  
"Route list" for navigation [127](#)  
Route map [127](#)  
"Route preference", changing [122](#)  
Route selection [122](#)  
Run-flat tires [172](#)  
– continuing driving with a damaged tire [85](#)  
– flat tire [85](#)  
– tire inflation pressure [168](#)  
– tire replacement [172](#)  
– winter tires [173](#)

## S

- Safety belts [48](#)
  - damage [49](#)
  - indicator lamp [49](#)
  - sitting safely [44](#)
- Safety belt tensioners, refer to Safety belts [48](#)
- Safety systems
  - ABS Antilock Brake System [81](#)
  - airbags [86](#)
  - DSC Dynamic Stability Control [82](#)
  - rollover protection system, Convertible [87](#)
  - safety belts [48](#)
- Satellite radio [140](#)
  - enabling channels [140](#)
  - selecting channel [141](#)
  - storing channel [141](#)
- "SAT" on the radio [133](#), [140](#)
- "Save current destination" [122](#)
- Scan
  - CD changer [145](#)
  - CD player [145](#)
  - radio [137](#)
- "Scan", playing stations [137](#)
- "Scan", playing tracks [145](#)
- Screen, refer to Control Center [16](#)
- Screw thread for tow fitting [188](#)
- Seats [44](#)
  - adjusting [45](#)
  - heating [49](#)
  - lumbar support [45](#)
  - memory, refer to Seat, mirror and steering wheel memory [46](#)
  - sitting safely [44](#)
  - sports seat [45](#)
  - storing the setting [46](#)
  - thigh support [45](#)
- Securing cargo [111](#)
  - ski bag [104](#)
- "Select as destination" [119](#)
- "Select current speed" [76](#)
- Selecting audio sources, refer to Operation using Control Center [132](#)
- Selecting distance for the active cruise control [65](#)
- Selecting frequency manually [137](#)
- Selecting menu [19](#)
- Selecting new scale for navigation system display [127](#)
- Selecting route [122](#)
- Selection options with navigation system [122](#)
- Selector lever
  - automatic transmission with Steptronic [58](#)
  - manual transmission [56](#)
  - SMG Sequential manual transmission [56](#)
- Selector lever interlock, refer to Shiftlock
  - automatic transmission with Steptronic [58](#)
  - SMG Sequential manual transmission [57](#)
- Sequential manual transmission, SMG [56](#)
- "Service" [70](#), [160](#)
- Service, refer to Roadside Assistance [186](#)
- Service and Warranty Information Booklet for US models [178](#)
- Service interval display, refer to Service requirements [70](#)
- "Service notification" [161](#)
- "Service Request" [162](#)
- "Service requirements" [70](#), [160](#)
- Service requirements [70](#)
  - also refer to CBS Condition Based Service [178](#)
- "Service Status" [160](#)
- "Set date" [79](#)
- "Set" in audio mode [133](#)
- "Set service date" [71](#)
- "Set time" [78](#)
- Setting road-speed limit [76](#)
- Settings
  - changing on Control Display [77](#)
  - configuring, refer to Key Memory [28](#)
- Setting time, refer to Preselecting activation time [98](#)
- "Set tire pressure" [84](#)
- Shifting
  - automatic transmission with Steptronic [58](#)
  - SMG Sequential manual transmission [57](#)
- Shifting paddles [57](#)
- Shiftlock
  - automatic transmission with Steptronic [58](#)
  - SMG Sequential manual transmission [57](#)
- Short commands of the voice command system [196](#)
- Shortest route for navigation [122](#)
- "Short route" for navigation [122](#)
- "Show current position" [118](#)
- "Show destination position" [118](#)
- Side airbags [86](#)
- Side marker lamps, replacing bulbs [182](#)
- Side turn signals, replacing bulbs [182](#)
- Sill panel lighting [93](#)
- Sitting safely [44](#)
  - with airbags [44](#)
  - with safety belts [44](#)
- Ski bag [104](#)
- Sliding/tilt sunroof, refer to Glass sunroof, electric with raise function [37](#)

SMG Sequential manual transmission [56](#)  
– acceleration assistant [59](#)  
– breaking-in [108](#)  
– convenience start [55](#)  
– Dynamic Driving Control [59](#)  
– gear display [57](#)  
– kick-down [57](#)  
– shiftlock [57](#)  
– towing [188](#)  
– tow-starting [189](#)  
"SMS" [155](#)  
Snow chains [173](#)  
Socket [103](#)  
– for Onboard Diagnostics interface [179](#)  
– in front passenger footwell [104](#)  
SOS, refer to Initiating emergency call [185](#)  
Sound output for Entertainment on/off [133](#)  
Spare fuses [184](#)  
Spare key [28](#)  
Special oils, refer to Specified engine oils [176](#)  
Specified engine oils [176](#)  
Speed-dependent volume [134](#)  
Speed limit [76](#)  
Speed limit warning, refer to Speed limit [76](#)  
Speedometer [12](#)  
"Speed volume", refer to Tone control [134](#)  
Speed with winter tires [173](#)  
Sport program  
– automatic transmission with Steptronic [58](#)  
– refer to Dynamic Driving Control [59](#)  
Stability control, refer to Driving stability control systems [81](#)  
"Star button" [51](#)  
"Start" for stopwatch [77](#)  
"Start guidance" [117](#), [124](#)

Starting difficulties, refer to Special starting conditions [54](#)  
Starting engine [54](#)  
Starting problems  
– jump starting [186](#)  
Start menu on Control Display [17](#)  
"Start route guidance" [118](#)  
"Start service" [161](#)  
"State / Province" for destination entry [116](#)  
"State inspection" [71](#)  
Station, refer to Radio [136](#)  
"Status" [70](#)  
Status of this Owner's Manual at time of printing [5](#)  
Steering wheel [11](#)  
– adjustment [50](#)  
– automatic adjustment, refer to Easy entry/exit [50](#)  
– buttons on steering wheel [11](#)  
– heating [51](#)  
– memory [46](#)  
– programmable buttons [51](#)  
"Steering wheel buttons" [51](#)  
Steering with variable ratio, refer to Active steering [85](#)  
Steptronic, refer to Automatic transmission with Steptronic [58](#)  
"Stop" for stopwatch [77](#)  
"Stopwatch" [77](#)  
Stopwatch [77](#)  
Storage compartments [102](#)  
"Store current destination" [122](#)  
"Store current position" [122](#)  
"Store in address book" for navigation [120](#)  
"Store" on the radio [138](#), [142](#)  
Storing current position [120](#)  
Storing sitting position, refer to Seat, mirror and steering wheel memory [46](#)  
Storing tires [173](#)

Straps, refer to Loading [111](#)  
"Street" for destination entry [117](#)  
Summer tires, refer to Wheels and tires [168](#)  
SW, waveband [136](#)  
Switches, refer to Cockpit [10](#)  
Switching navigation voice instructions on/off [126](#)  
Switching off engine [55](#)  
Switching off the interior motion sensor [35](#)  
Switching off the tilt alarm sensor [35](#)  
Switching on  
– audio [132](#)  
– CD changer [132](#)  
– CD player [132](#)  
– radio [132](#)  
Switching on hour signal [78](#)  
Switching the cooling function on and off [95](#)  
Swiveling headlamps, refer to Adaptive Head Light [92](#)  
Symbols [4](#)  
– indicator and warning lamps [13](#)

## T

Tachometer [69](#)  
Tail lamps [182](#)  
– replacing bulbs [182](#)  
Tank capacity, refer to Fuel tank capacity [166](#)  
Target cursor for navigation [118](#)  
Technical changes, refer to For your own safety [6](#)  
Technical data [192](#)  
Telematik, refer to TeleService, BMW Assist [159](#)  
Telephone  
– refer to Portable phone [150](#)  
– refer to separate Owner's Manual  
"Telephone list" [51](#)

- TeleService 159
  - enabling 159
  - services offered 160
  - Temperature display
  - ice warning 69
  - outside temperature 69
  - setting measurement units 69
  - Temperature gage
  - engine oil 70
  - Tempomat, refer to Cruise control 61
  - "Terminate services" 162
  - "Text language" 78
  - "Theater" 135
  - The individual vehicle 5
  - Tilt function, passenger-side mirror 47
  - "Time" 78
  - "Time 1" for independent ventilation 98
  - "Time 2" for independent ventilation 98
  - "Time format" 78
  - Timer, refer to Preselecting activation time 98
  - Tire pressure monitoring, refer to Flat Tire Monitor 84
  - Tire Quality Grading 170
  - Tires
  - age 170
  - air loss 85
  - breaking-in 108
  - changing 172
  - condition 171
  - damage 171
  - flat tire 85
  - inflation pressure 168
  - new wheels and tires 172
  - pressure monitoring, refer to Flat Tire Monitor 84
  - replacing 172
  - retreaded tires 172
  - run-flat tires 172
  - size 169
  - tread 171
  - wear indicators 171
  - wheel/tire combination 172
  - winter tires 172
  - "Tone" 134
  - Tone in audio mode
  - adjusting 133
  - middle setting 135
  - Tools, refer to Onboard tool kit 180
  - "Top 8" for portable phone 154
  - Torque, refer to Engine specifications 192
  - Touch tone dialing 155
  - Tow fitting 188
  - Towing 188
  - tow fitting 188
  - "Town / City" for destination entry 116
  - Tow-starting 189
  - Tracks
  - random play sequence 145
  - sample, Scan 145
  - Track width, refer to Dimensions 193
  - Traction control, refer to DSC Dynamic Stability Control 82
  - Traffic congestion, refer to Bypassing route sections 128
  - Transmission
  - automatic transmission with Steptronic 58
  - manual transmission 56
  - SMG Sequential manual transmission 56
  - Transporting children safely 52
  - Transport securing device, refer to Securing load 111
  - Tread depth, refer to Minimum tread depth 171
  - "Treble", refer to Tone control 134
  - "Trip computer" 75
  - Trip computer 75
  - Trip-distance counter, refer to Trip odometer 69
  - "Triple turn signal activation" 60
  - Trip odometer 69
  - Trunk, refer to Luggage compartment 34
  - Trunk lid, refer to Luggage compartment lid 32
  - Turning circle, refer to Dimensions 193
  - Turn signals 60
  - indicator lamp 13
  - replacing bulbs 181
- ## U
- Undercarriage protection, refer to the Caring for your vehicle brochure
  - Uniform Tire Quality Grading/UTQR 170
  - "Units" 78
  - Units
  - average fuel consumption 77
  - temperature 77
  - Universal garage-door opener, refer to Integrated universal remote control 100
  - Universal remote control, refer to Integrated universal remote control 100
  - "Unlock button" 29
  - Unlocking
  - from inside 32
  - from outside 29
  - Unlocking and locking doors, setting confirmation signals 30
  - "Update services" 162
  - "Use current location as address" 122

## V

- Vehicle
  - battery [183](#)
  - breaking-in [108](#)
  - care, refer to the Caring for your vehicle brochure
  - cargo loading [110](#)
  - decommissioning, refer to the Caring for your vehicle brochure
  - dimensions [193](#)
  - parking [55](#)
  - washing, refer to the Caring for your vehicle brochure
  - weights [192](#)
- Vehicle jack [183](#)
- jacking points [183](#)
- Vehicle position, refer to Displaying current position [125](#)
- "Vehicle settings" [29](#)
- Ventilating
  - independent ventilation [98](#)
  - refer to Ventilation [97](#)
- Ventilation [97](#)
  - draft-free [97](#)
- Vent outlets of automatic climate control [94](#)
- Voice command system [22](#)
  - short commands [196](#)
- Voice instructions for navigation system [126](#)
  - muting [51](#)
  - repeating [51](#), [126](#)
  - switching on/off [51](#), [126](#)
  - volume [126](#)
- Voice phone book [157](#)
- Volume [132](#)
  - audio sources [132](#)
  - portable phone [151](#), [157](#)
  - setting speed-dependent [134](#)
  - voice instructions [126](#)
- Volume adjustment in audio mode, front-to-rear [134](#)

## W

- Warning lamps, refer to Indicator/warning lamps [13](#)
- Warning messages, refer to Check Control [71](#)
- Warning triangle [186](#)
- Warranty and Service Guide Booklet for Canadian models [178](#)
- Washer fluid
  - capacity of the reservoir [61](#)
  - wiper system [61](#)
- Washer fluid reservoir [61](#)
- Water on roads, refer to Driving through water [109](#)
- Waveband [136](#)
- "WB" [133](#), [139](#)
- Wear indicators in tires, refer to Minimum tread depth [171](#)
- Weights [192](#)
- Wheel/tire combination, refer to New wheels and tires [172](#)
- Wheel/tire replacement, refer to New wheels and tires [172](#)
- Wheelbase, refer to Dimensions [193](#)
- Wheels and tires [168](#)
- Width, refer to Dimensions [193](#)
- Wind deflector [42](#)
- Windows [35](#)
  - convenience operation [30](#), [31](#)
  - opening and closing, Convertible [36](#)
  - opening and closing, Coupe [36](#)
  - rear window, Convertible [37](#)
- Windshield washer nozzles [61](#)
- Windshield washer system, refer to Washer/wiper system [61](#)
- Windshield wiper blade replacement [180](#)
- Windshield wipers, refer to Wiper/washer system [60](#)

- Winter tires [172](#)
  - setting speed limit [76](#)
  - storage [173](#)
- Wiper blade replacement [180](#)
- Wiper system [60](#)
  - washer fluid [61](#)
  - windshield washer nozzles [61](#)
- "With highways" for navigation [122](#)
- Word matching principle for navigation [123](#)
- Working in the engine compartment [174](#)
- Wrenches/screwdrivers, refer to Onboard tool kit [180](#)

## X

- Xenon lamps [180](#)
  - replacing bulbs [180](#)

## Refueling

To ensure that you always have all the essential data at hand when refueling, we recommend that you fill in the following tables with the specifications and information that apply to your vehicle. Consult the index for individual specifications.

### Fuel

Designation

Please enter your preferred fuel here.

### Engine oil

Quality

The oil quantity between the middle of the two marks on the dipstick is approx. 1.6 US quarts/ 1.5 liters.

## Tire inflation pressures

	Summer tires Front	Rear	Winter tires Front	Rear
Up to 2 persons				
4 Persons or 4 Persons plus luggage				

More about BMW

[bmwusa.com](http://bmwusa.com)



The Ultimate  
Driving Machine

01 41 0 158 445 ue





