

Owner's Manual
for Vehicle



The Ultimate
Driving Machine



745i
745Li

Congratulations, and thank you for choosing a BMW.

Thorough familiarity with your vehicle will provide you with enhanced control and security when you drive it. We therefore have this request:

760i
760Li

Please take the time to read this Owner's Manual and familiarize yourself with the information that we have compiled for you before starting off in your new vehicle. It contains important data and instructions intended to assist you in gaining maximum use and satisfaction from your BMW's unique range of technical features. The manual also contains information on maintenance designed to enhance operating safety and contribute to maintaining the value of your BMW throughout an extended service life.

This Owner's Manual should be considered a permanent part of this vehicle. It should stay with the vehicle when sold to provide the next owner with important operating, safety and maintenance information.

This manual is supplemented by a Service and Warranty Information Booklet for US models or a Warranty and Service Guide Booklet for Canadian models. We wish you an enjoyable driving experience.

BMW AG

© 2004 Bayerische Motoren Werke
Aktiengesellschaft
Munich, Germany
Reprinting, including excerpts,
only with the written consent of
BMW AG, Munich.
Order No. 01 41 0 159 154
US English VIII/04, 6 146
Printed in Germany
Printed on environmentally friendly paper,
bleached without chlorine, suitable for recycling.

Contents

The fastest way to find specific topics is to use the index, refer to page 218.

Using this Owner's Manual

- 4 Notes
- 7 Reporting safety defects

At a glance

- 10 Cockpit
- 17 Control Center
- 26 Voice command

Controls

- 34 Opening and closing
- 46 Adjustments
- 58 Transporting children safely
- 62 Driving
- 81 Everything under control
- 91 Technology for comfort, convenience and safety
- 100 Lamps
- 103 A congenial climate
- 112 Practical interior accessories

Driving tips

- 122 Things to remember when driving

Navigation

- 130 Starting navigation system
- 132 Destination entry
- 139 Destination guidance
- 145 What to do if ...

Entertainment

- 148 On/off, tone
- 152 Radio
- 158 CD Compact Disc
- 160 CD changer
- 163 TV
- 165 DVD changer

Communications

- 174 Using the phone in your vehicle
- 182 BMW Assist

Mobility

- 186 Refueling
- 188 Wheels and tires
- 194 Under the hood
- 198 Maintenance
- 200 Rules and regulations
- 201 Replacing components
- 209 Giving and receiving assistance

Reference

- 214 Technical data
- 218 Everything from A to Z

Notes

Using this Owner's Manual

In compiling this Owner's Manual we have made every effort to furnish you with a convenient reference source affording quick access to all the essentials. The fastest way to find detailed information on any specific subject is to turn to the comprehensive index at the back of the manual. For a brief initial overview, please refer to the first chapter.

Should the day come when you decide to sell your BMW, please remember to make certain that the new owner receives this Owner's Manual; it is an important part of the vehicle.

Additional sources of information

If you have any additional questions, your BMW center will be glad to advise you.

You can find information on BMW, e.g. technology, on the Internet at www.bmwusa.com.

Symbols used



Indicates precautions that must be followed precisely in order to avoid the possibility of personal injury and serious damage to the vehicle.

◀ Marks the end of a specific item of information.



Contains information that will assist you in gaining the optimum benefit from your vehicle and enable you to care more effectively for your vehicle.



Refers to measures that can be taken to help protect the environment.

* Indicates special equipment, country-specific equipment and optional extras when available.

"..." Identifies Control Display texts used to select individual functions.



These sections contain information on using the voice command system.

}...{ Verbal instructions to use with the voice command system.

>>...<< Identifies the answers generated by the voice command system.



Vehicle Memory, Key Memory, refer to page 56. Identifies functions that can be specifically adapted for a particular key or vehicle. These adjustments can be performed either by yourself or by your BMW center.

Symbols on vehicle components



Indicates that you should consult the relevant section of this Owner's Manual for information on a particular part or assembly.

Your individual vehicle

On purchasing your BMW, you have decided in favor of a model with individualized equipment and features. This Owner's Manual describes the entire array of options and equipment available with a specific BMW model.

Please bear in mind that the manual may contain information on accessories and equipment that you have not specified for your own vehicle. Sections describing options and special equipment are marked by asterisks * to assist you in identifying possible differences between the descriptions in this manual and your own vehicle's equipment.

Should your BMW be equipped with features or accessories not described in this Owner's Manual, please consult the enclosed Supplementary Owner's Manual(s).

Editorial notice

BMW pursues a policy of continuous, ongoing development that is conceived to ensure that our vehicles continue to embody the highest quality and safety standards combined with advanced, state-of-the-art technology.

For this reason, the features described in this Owner's Manual may differ from those on your vehicle. Nor can errors and omissions be entirely ruled out. You are therefore asked to appreciate that no claims can be entertained on the basis of the data, illustrations or descriptions in this Owner's Manual.

For your own safety

Maintenance and repair



Advanced technology, e.g. the use of modern materials and high-performance electronics, requires specially adapted maintenance and repair methods. Therefore, only have corresponding work on your BMW carried out by a BMW center or a workshop that works according to BMW repair procedures with correspondingly trained personnel. If work is carried out improperly there is a danger of consequential damage and the related safety risks. ◀

Parts and accessories



For your own safety, use genuine parts and accessories approved by BMW.

When you purchase accessories tested and approved by BMW and Genuine BMW Parts, you simultaneously acquire the assurance that they have been thoroughly tested by BMW to ensure optimized performance when installed on your vehicle. BMW warrants these parts to be free from defects in material and workmanship. BMW will not accept any liability for damage resulting from installation of parts and accessories not approved by BMW. BMW cannot test every product made by other manufacturers to verify if it can be used on a BMW safely and without risk to either the vehicle, its operation, or its occupants.

Genuine BMW Parts, BMW Accessories and other products approved by BMW, together with professional advice on using these items, are available from all BMW centers.

Installation and operation of non-BMW approved accessories such as alarms, radios, amplifiers, radar detectors, wheels, suspension components, brake dust shields, telephones, including operation of any mobile phone from within the vehicle without using an externally mounted antenna, or transceiver equipment, for instance, CBs, walkie-talkie, ham radio or

similar accessories, may cause extensive damage to the vehicle, compromise its safety, interfere with the vehicle's electrical system or affect the validity of the BMW Limited Warranty. Refer to your BMW center for additional information. ◀



Maintenance, replacement, or repair of the emission control devices and systems may be performed by any automotive repair establishment or individual using any certified automotive part. ◀

Service and warranty

We recommend that you read this publication thoroughly.

Your BMW is covered by the following warranties:

- New Vehicle Limited Warranty
- Rust Perforation Limited Warranty
- Federal Emissions System Defect Warranty
- Federal Emissions Performance Warranty
- California Emission Control System Limited Warranty

Detailed information about these warranties is listed in the Service and Warranty Information Booklet for US models or in the Warranty and Service Guide Booklet for Canadian models.

Reporting safety defects

The following only applies to vehicles owned and operated in the US.

If you believe that your vehicle has a defect which could cause a crash or could cause injury or death, you should immediately inform the National Highway Traffic Safety Administration (NHTSA) in addition to notifying BMW of North America, LLC, P.O. Box 1227, Westwood, New Jersey 07675-1227, Telephone (800) 831-1117.

If NHTSA receives similar complaints, it may open an investigation, and if it finds that a safety defect exists in a group of vehicles, it may order a recall and remedy campaign. However, NHTSA cannot become involved in individual problems between you, your dealer, or BMW of North America, LLC.

To contact NHTSA, you may either call the Auto Safety Hotline toll-free at 1-800-424-9393 (or 366-0123 in Washington, D.C. area) or write to: NHTSA, U.S. Department of Transportation, Washington, D.C. 20590. You can also obtain other information about motor vehicle safety from the Hotline.











At a glance

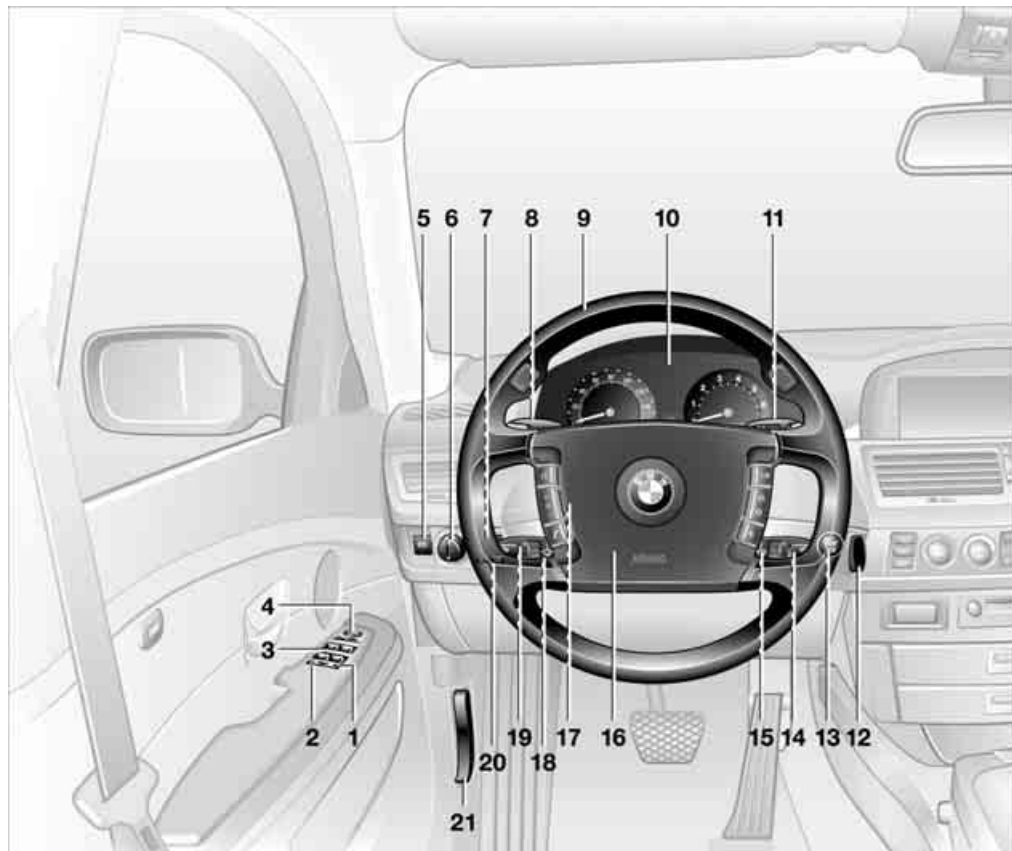









This overview of buttons, switches and displays is intended to serve as a source of orientation in your vehicle's operating environment. The section will also assist you in becoming acquainted with the control concepts and options available for operating the various systems.

Cockpit

All around the steering wheel: controls and displays



- 1 Roller sun blind for rear window* 113
- 2 Rear window safety switch 44
- 3 Power windows 43
- 4 Exterior mirrors 53
- 5 Parking brake 64
- 6 Parking lamps and low beams 100
- 7  Instrument lighting 101
- 8  Turn signals 71
-  High-beams, headlamp flasher 101
-  Computer 85
Check Control 83
-  Computer 85
-  Standing lamps 101
- 9 Steering wheel 16
- 10 Info Display 12
- 11 Automatic transmission lever 68

- 12 Ignition lock 62
- 13  Switching ignition on/off and starting engine 62
- 14  Windshield wipers 72
-  Rain sensor 72
- 15  PDC Park Distance Control* 91
- 16 Horn: the entire surface
- 17  Steering wheel heater* 54
-  Steering wheel adjustment 54
- 18  Unlocking luggage compartment 40
- 19  Programmable cruise control 73
-  Active cruise control* 75
- 20 Fog lamps 101
-  Front fog lamps
- 21 Unlocking the engine hood 194

Info Display

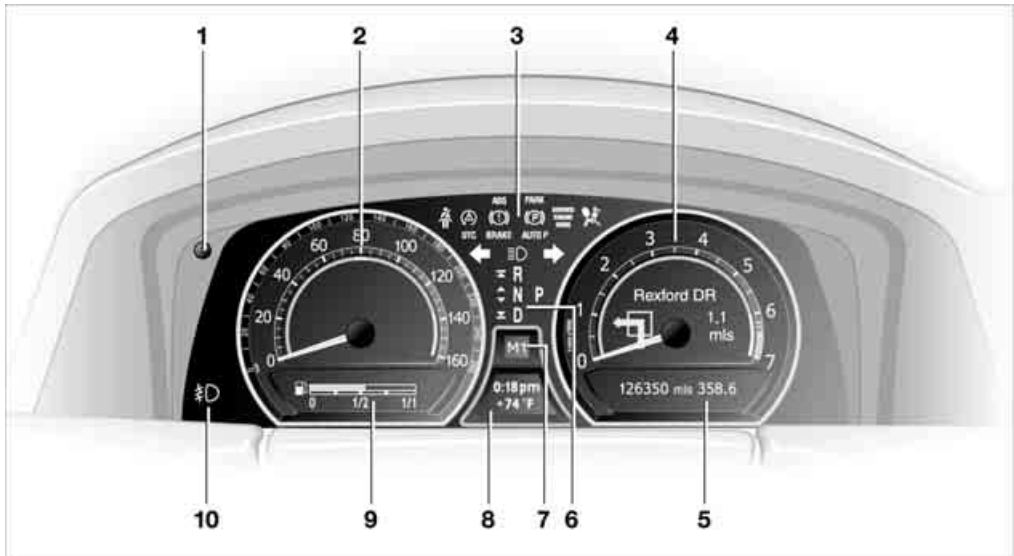

VW.com

- | | |
|---|---|
| <p>1 To view odometer display and reset trip odometer to zero 81</p> <p>2 Speedometer with display for</p> <ul style="list-style-type: none"> ▷ Programmable cruise control 73 or ▷ Active cruise control* 75 ▷ Speed limit 87 <p>3 Fixed indicator and warning lamps 13</p> <p>4 Tachometer 81 Destination guidance of navigation system* 139</p> <p>5 Display for</p> <ul style="list-style-type: none"> ▷ Computer 85 or ▷ Text message of the Check Control 83 or ▷ Voice command system* 26 | <p>6 Transmission range selection 68</p> <p>7 Automatic transmission program display 68</p> <p>8 Display for</p> <ul style="list-style-type: none"> ▷ Clock 90 ▷ Outside temperature 81 or ▷ Variable indicator and warning lamps 83 <p>9 Computer with fuel gauge 85</p> <p>10 Fog lamps 101</p> |
|---|---|

Indicator and warning lamps

Technology that monitors itself

The indicator and warning lamps identified by the ● symbol are subjected to an operation check each time you switch on the ignition or start the engine. They each light up once for different periods of time.

When a malfunction occurs in a monitored system, the corresponding lamp will either fail to go out when the engine is started, or it will come on again during normal driving. Detailed information is provided on the specified pages.

Fixed indicator and warning lamps



Please fasten safety belts ● 51



DSC Dynamic Stability Control ● 93



DTC Dynamic Traction Control 93



ABS Antilock Brake System ● 92



Brake system ●
With other warning lamps 94, 197



Warning lamp on Canadian models



With parking brake released 66
With parking brake set 64



Warning lamp on Canadian models



Automatic parking brake,
Automatic Hold ● 65, 66



Service Engine Soon ● 200



Indicator lamp on Canadian models



Airbags ● 98



Turn signals 71



High beams/
headlamp flasher 101



Front fog lamps 101

Colors

The indicator and warning lamps can light up in different colors and combinations.

- ▷ Red:
Stop the vehicle immediately or an important reminder
- ▷ Red and yellow:
Continue to drive; drive cautiously
- ▷ Yellow:
Have the system inspected at the earliest opportunity or for your information
- ▷ Green:
For your information
- ▷ Blue:
For your information.

Variable indicator and warning lamps

In the display **8** of the Info Display, additional indicator and warning lamps appear when necessary. Observe the instructions for action of the accompanying Check Control messages, also refer to page **83**.

Comfort area: controls and displays

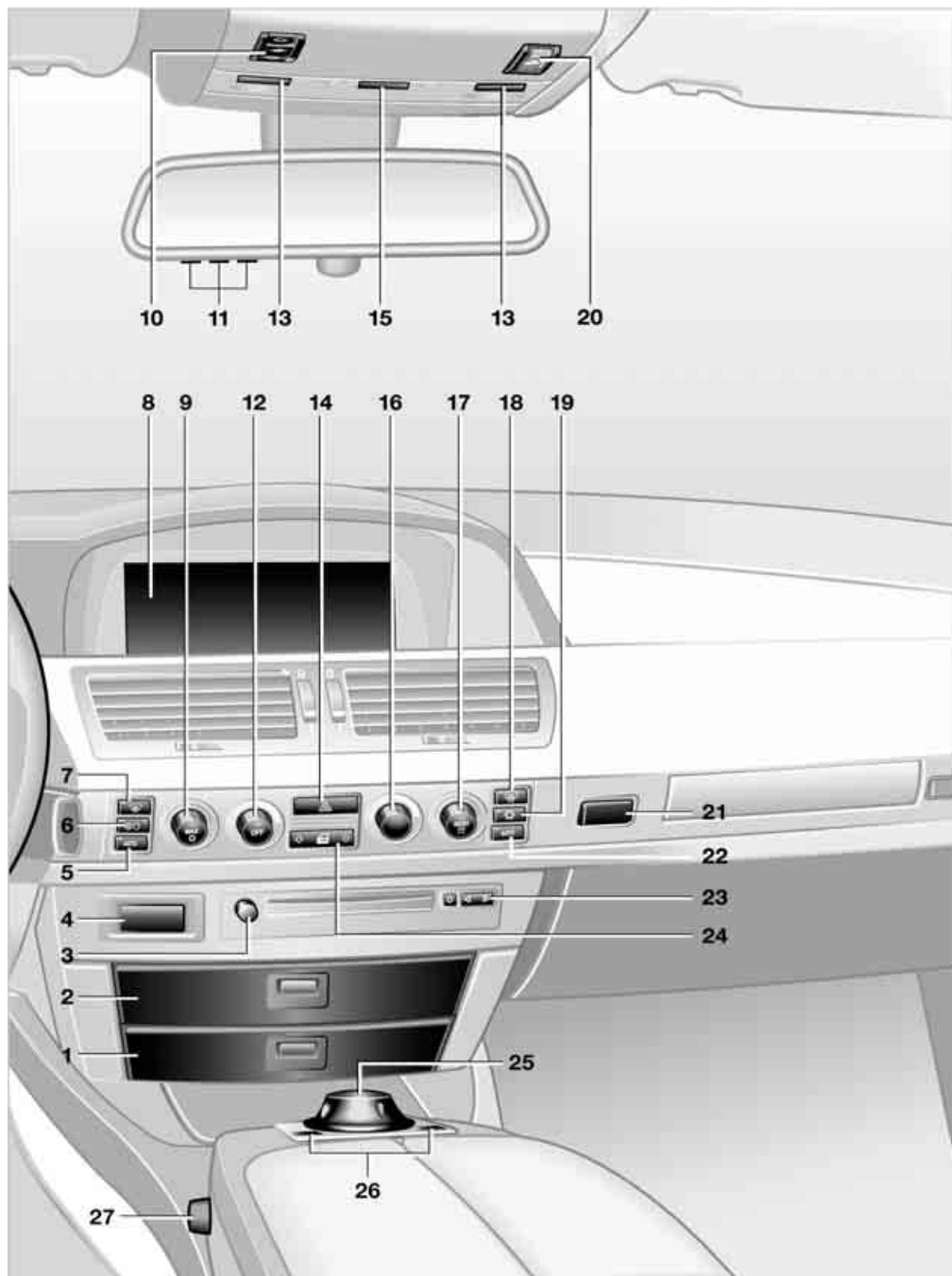

- 1 Glasses compartment [116](#)
- 2 Storage compartment [116](#)
- 3 Switching audio and video sources on/off and adjusting volume [149](#)
- 4 Telephone keypad, folding [176](#)
- 5 Automatic air distribution and supply, left side of passenger compartment [104](#)
- 6 Outside air/AUC Automatic recirculated-air control/Recirculated air [105](#)
- 7 Defrosting windshield and windows and removing condensation [105](#)
- 8 Control Display [17](#)
- 9 Temperature, left side of passenger compartment: turn
For maximum cooling: press [105](#)
- 10 Glass roof, electric* [44](#)
- 11 Memory keys for integrated universal remote control* [112](#)
- 12 Air supply, left side of passenger compartment: turn
To switch off automatic climate control: press [105](#), [107](#)
- 13 Reading lamps [102](#)
- 14 Hazard warning flashers
- 15 Interior lamps [102](#)
- 16 Air supply on right side of passenger compartment [104](#)
- 17 Temperature, right side of passenger compartment: turn
For residual heat utilization: press [105](#)
- 18 Rear window defroster
- 19 Air conditioning [105](#)
- 20 Starting an emergency call [177](#)
- 21 Opening the glove compartment
- 22 Automatic air distribution and supply, right side of passenger compartment [107](#)
- 23 Station/track search and CD*, TV* and DVD* [148](#)
- 24 Central locking system [38](#)
- 25 Controller [17](#)
- 26 Control Center buttons [17](#)
- 27 Seat adjustment [47](#)



Heated seats* [52](#)



Active seat ventilation* [52](#)



Active seat for driver* [53](#)



Seat, mirror and steering wheel memory [55](#)

Buttons on steering wheel

Buttons are integrated in the steering wheel for fast operation of the following functions without being distracted from driving:

- ▷ The Steptronic of the automatic transmission
- ▷ Selected audio source functions
- ▷ Selected portable phone functions
- ▷ The voice command system
- ▷ Selected TV and DVD functions.

 The buttons on the steering wheel are only operational when the corresponding systems are switched on. ◀



Telephone:
Accept call, make calls, end call



Volume



Voice command system*:
Switch on and off



Fast forward/reverse:

- ▷ Radio
Press briefly: next stored station
Extended pressure: automatic tuning
- ▷ CD*
Press briefly: skipping tracks
Extended pressure: fast forward/
reverse
- ▷ TV*
Select station
- ▷ DVD*
Search for chapter



Available for individual programming:
Programming button function, refer to page 54.



Steptronic:
Press briefly to proceed through a selection sequence consisting of the automatic program, the Sport program, and the manual mode, refer to page 68.



Steptronic: upshifting and downshifting,
refer to page 70.

Control Center

The concept

The Control Center has been designed to avoid the unnecessary complexity created by an extended number of switches and controls. It consists of the controller and the Control Display.

The controller is used to select the functions that will appear on the Control Display. In addition, it also shows you the Check Control messages, refer to page 83.

Controls

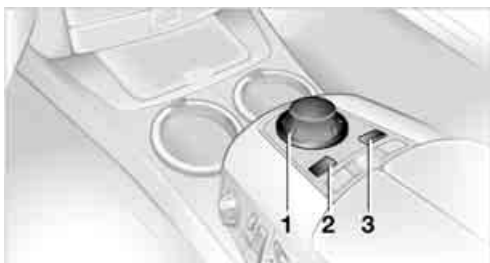

- 1 Controller: you operate all the functions in the Control Center by moving, turning and pressing.
If you move the controller
 - ▷ you feel the mechanical guides along the main direction of movement. This makes it easier for you to select the right main menus
 - ▷ If you turn the controller, you feel an electronically created rasterizing. This helps you to select the desired menu item
- 2 Button for opening the start menu from any menu item
- 3 Individual button assignment



To avoid posing an unnecessary hazard, both to your own vehicle's occupants and to other road users: never attempt to use the controls or make adjustments unless traffic and road conditions allow. ◀



The following introduction illustrates how easy it is to use the Control Center.

You can find detailed instructions describing how to use the individual systems in the separate sections.

Programming button function



You can assign specific individual functions to the programmable button. This feature then provides you with quick access to this function, allowing you to control it without undue distraction from road and traffic conditions.

1. Select "Settings" and press the controller
2. Select  and press the controller
3. Select . Continue to press the controller until the desired function appears:
 - ▷ "Mode"
You can choose between the output sources radio/FM or AM, compact-disc CD and CD changer. The precondition is that one of these sources has been activated
 - ▷ "FM" or "AM"
Switching over between wavebands FM and AM, also refer to page 152
 - ▷ "Brief info"
Display of the help and supplementary texts of the active menu for approx. 10 seconds, refer to Assistance window on page 22.



Select  button. Continue to press the controller until the desired function appears.

 The "Brief info" function is not available in the rear. ◀

Control Display



To open the start menu:

Press the button



or

move the controller

- ▶ toward the currently active menu
- ▶ twice in one direction.

To switch off the Control Display, press the controller when you are in the start menu.

 When the Control Display appears, you see the start menu for approx. 5 seconds, then the last active menu. You can have the display of the start menu deactivated at your BMW center. ◀

Selecting menu



Move the controller to select a menu, here: "Settings".

The menu appears on the screen as soon as you release the controller.

 You can change directly to a different menu by moving the controller in the desired direction. ◀

Selecting menu items



Turn the controller to select the menu item, here: "Clock".

Confirming selection or entry



Press the controller to confirm the selection, here: "Clock".



Select the desired setting for adjustment from the menu item, here: "Time" and confirm your entry.

Settings

The first setting option for time is activated.



- ▶ Turn the controller to make the adjustment
- ▶ Press the controller to confirm the new setting, i.e. to store it, and to proceed to the next highlighted position to adjust.

Changing menu page



You can select individual pages in specific menus, here: "Climate".

Select the symbol and press the controller:

- ▣ To select the second page of the menu
- ▣ To return to the first page of the menu.



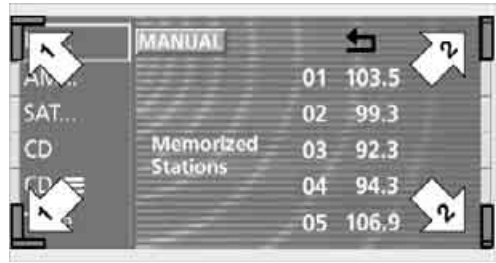







Symbols and lists



The symbols in the corners and edges of the Control Display have various functions:

- 1 Corner symbols:
These symbols take you to the next menu item or in a displayed list.
To do so: turn the controller
- 2 List symbols:
Indicates that you can only move within the displayed list, here: stored radio stations.
Turn the controller to select an entry from the list.
To exit the list again:
Select  and confirm your selection.
You can also leave the list by turning the controller to the left or right

Symbols

-  To select the second page
-  To return to the first page
-  To exit from the list
-  To transfer the current display to the assistance window. For more detailed information on the assistance window, refer to page [22](#)
-  To transmit vehicle data to BMW Service Center
-  To set display units and formats, refer to page [89](#)
-  To change the language of the display texts, refer to page [89](#)
-  To select settings for vehicle functions
-  Programmable function key, refer to page [54](#)
-  Programmable function key, refer to page [17](#)
-  To set the brightness of the screen, refer to page [90](#)

Menus in Control Display

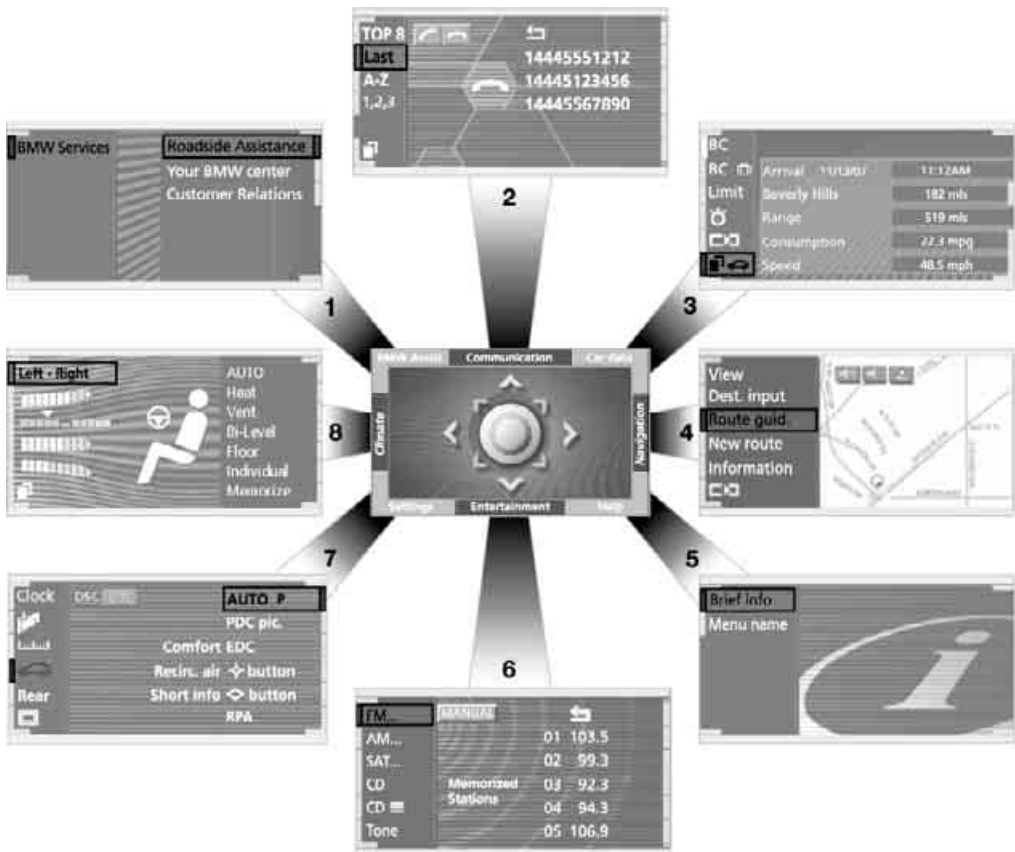

You can select from an extended range of functions and setting options:

- 1 BMW Assist* [182](#)
- 2 Communication
 - ▷ Using the phone [174](#)
 - ▷ Portable phone, refer to separate Owner's Manual
- 3 Car data
 - ▷ Computer [85](#)
 - ▷ Limit [87](#)
 - ▷ Stopwatch [88](#)
 - ▷ Service required [82](#)
 - ▷ Accessing Check Control messages [83](#)

- 4 Navigation* [130](#)
- 5 Help
 - ▷ Brief help text displays [22](#)
 - ▷ Menu name for menu change
- 6 Entertainment
 - ▷ Radio [152](#)
 - ▷ CD player* [158](#)
 - ▷ CD changer* [160](#)
 - ▷ TV* [163](#)
 - ▷ DVD* [165](#)

- 7 Settings
 - ▷ Vehicle functions 54, 65, 91
 - ▷ Time and date 90
 - ▷ Language 89
 - ▷ Units of measure and display format 89
 - ▷ Brightness 90
 - ▷ Lock Control Center in rear* 24
- 8 Climate
 - ▷ Automatic climate control 103
 - ▷ Heated seats* 52
 - ▷ Independent ventilation 110

Assistance window*

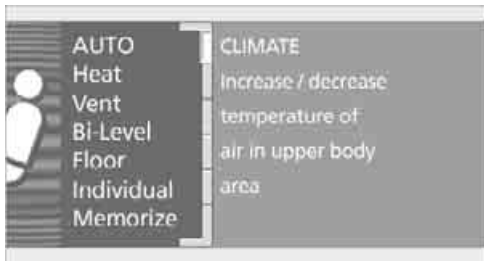

While you use the Control Center, the assistance window can provide you with a parallel display for the active system.

You can use it for displays of the following:

- ▷ Short help and supplementary information texts for selected menu items
- ▷ A function selected in the "Car data" menu, refer to page 89
- ▷ The route for vehicles with a navigation system, refer to page 131.

Help texts in assistance window

You can call up and also cancel displays containing help texts and supplementary information on selected menu items in the assistance window.

1. Select "Help" from the start menu
2. Select "Brief info" and confirm your selection. The help texts appear in the assistance window



3. Confirm again to hide the automatic display.

Showing menu name

You can program the system to display the menu name each time you proceed to a new menu.

1. Select "Help" from the start menu
2. Select "Menu name" and confirm your selection.



Top and bottom status lines

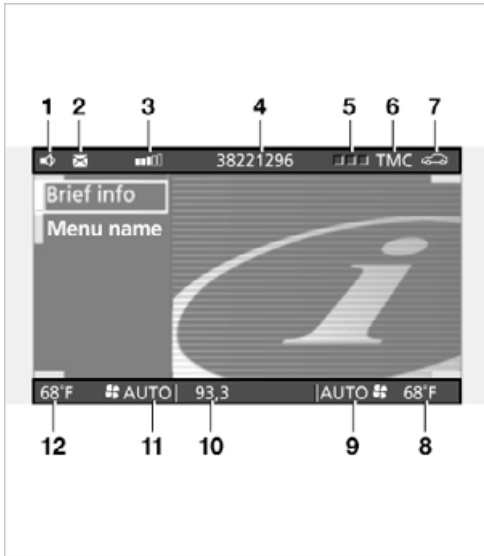

- 1 Hands-free mode active
- 2 Display field for calls received in absence
- 3 Portable phone reception strength
- 4 Display field
 - ▷ of the telephone provider
 - ▷ of the entered/selected phone number
- 5 Telephone status
 - ▷ Green: incoming or outgoing call
 - ▷ Red: no network available
 - ▷ Lit up yellow:
The network of another provider is being used, partner network
 - Flashing yellow:
The network of another provider is being used, external network
 - ▷ Roaming in a partner or external network entails higher call charges than in your home network. ◀

- 6 Traffic Message Channel activated, currently not available
- 7 Display of Check Control 83
 - ▷ Yellow: priority 2, the symbol flashes briefly. You can use the "Car data" menu to have the status report shown on the Control Display
 - ▷ Red: priority 1, these messages appear immediately, accompanied by a gong and a flashing symbol
- Status service requirement display 82
 - ▷ Red: at least one service interval has been exceeded
- 8 Temperature selection display, right side of passenger compartment
- 9 Air supply, right side of passenger compartment
- 10 Entertainment: display for radio, CD, TV, DVD
- 11 Air supply, left side of passenger compartment
- 12 Temperature selection display, left side of passenger compartment

Assistance window

The status lines in the assistance window show the following:

- ▷ Outside temperature
- ▷ Navigation system destination
- ▷ Time
- ▷ Date.

Control Center in rear*

Rear screen

Folding open rear screen:

1. Swing folding arm upward until it engages
2. Fold open rear screen.



The rear screen is ready for operation.

Folding down rear screen:

1. Align rear screen straight
2. Fold rear screen downward; folding arm unlocks
3. Swing folding arm downward.

 Swing the rear screen downward when the ski bag is used, as otherwise it could be damaged. Do not swing the rear screen up or down with the cup holders open, as otherwise it could be damaged. ◀

 The rear screen switches off automatically when it is swung downward. Some functions are not available on the rear screen, e.g. the BMW Assist function can only be operated in the front Control Display. Some functions only permit limited operation on the rear screen, e.g. the speed limit can only be displayed. Setting is carried out via the front controller, refer to page 87. ◀

Controller/buttons

The controller and buttons are located on the center armrest.

Rear lock

The available functions are operated with the respective controller. In the Control Center, you can limit or deactivate operation of the rear screen.

1. Select "Settings" and confirm your selection
2. Select "Rear" and confirm your selection
3. Set operation of rear screen:

▶ Select "Limited Release" and confirm to lock the functions used in the front Control Display

 When headphones are connected, all audio and video functions continue to be selectable in the rear, with the exception of the audio or video source activated in the front Control Display. ◀

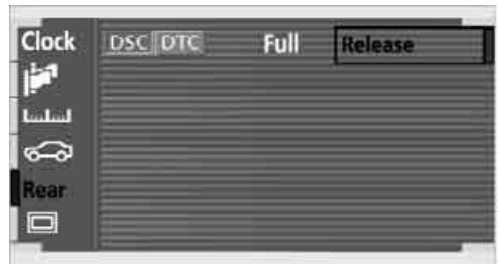

- ▶ Select "None Release" and confirm to switch off the rear screen
- ▶ Select "Full Release" and confirm to switch off all locks
- ▶ Select "Release" and confirm to switch individual menus on or off:

Communication: select "Comm." and confirm your selection.

Entertainment: select "Entertainm." and confirm your selection.

Headphones



- 1** Headphone jack
- 2** Adjusting volume
- 3** Station scan/track search
 - ▷ Station scan
 - ▷ Music track search for CD, search chapter for DVD changer
 - ▷ Select TV channels

Headphones are only intended for passengers in the rear seats. Please check with local regulations regarding use of headphones.

Voice command*

Voice command system

The concept

The voice command system allows you to control operation of various vehicle systems without ever removing your hands from the steering wheel. The system operates on the basis of voice commands that you will learn easily after using them a few times. In many cases, the voice command system supports you with announcements or questions while you are making your entries.

The voice command system transforms your oral commands and dialog answers into control signals for the selected systems.

 Please take the time to acquaint yourself with how a particular system operates before proceeding to control it using the voice command system. ◀

Symbols used

 These sections contain information on using the voice command system.

›...‹ Verbal instructions to use with the voice command system.

›...‹ Identifies the answers generated by the voice command system.

Systems available for use with voice command

- ▷ ›Telephone‹, refer to page 174
- ▷ ›Navigation‹, refer to page 130
- ▷ ›Radio‹, refer to page 152
- ▷ ›CD‹, refer to page 158
- ▷ ›CD changer‹, refer to page 160
- ▷ ›Notepad‹, refer to page 28
- ▷ ›TV‹, refer to page 163
- ▷ ›DVD‹, refer to page 165.

Either the system that you are now operating or any current error messages will appear in the Info Display, refer to page 27.

Voice commands

Voice command system activation

Briefly press the  button on the steering wheel.

A signal tone and "SVS active" in the Info Display, refer to page 27, indicate that the system is ready for use. You are automatically in the main menu.

From here, you can call up all the equipment that can be operated.

Canceling voice command

Briefly press the  button on the steering wheel

or

 ›Cancel‹.

In dialogs in which any text can be spoken, e.g. names, notes, canceling is only possible using the  button.

 The system automatically switches over to its telephone mode if you receive a call during voice command. "SVS off" appears in the Info Display, refer to page 27. ◀

Voice commands

The voice command system operates on the basis of specific, predefined commands; these commands should be spoken precisely as indicated. You can have the possible commands read back at any stage. To do so, say the command ›Options‹.

In addition to the commands described, there are often other commands that run the same function. Instead of ›Options‹, you can, for example, also say ›What now‹.

More detailed commands such as ›Change scale‹ instead of ›Scale‹ are also often possible.

Short commands

With the ›Main menu‹ level, you can run certain functions directly with brief commands, refer to page 29, without having to open an equipment level.

For example, if you want to dial a phone number, you do not have to say

›Telephone‹

rather you can say directly

1. ›Dial number‹
2. Enter the phone number.

Special commands

Special commands are available for specific systems. In this Owner's Manual you

will find these commands in the sections describing the individual systems.

Operation with the voice command system is always indicated with this pictograph.

Displays in Info Display

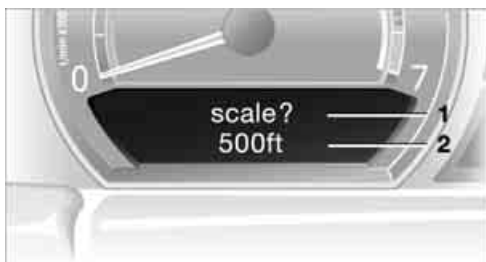

The Info Display shows you what the voice command system has understood in line 2, while also indicating which voice command or question is currently active in line 1. In addition, any error messages are also displayed.

Selecting navigation scale - an example

Start the dialog:

Briefly press in the steering wheel.

| You say | The voice command system replies | Info Display screen contents |
|---------------------|------------------------------------|------------------------------|
| | | "SVS active" |
| ›Change scale‹ | ››Please enter the desired scale‹‹ | "scale ? change scale" |
| ›Scale 500 feet‹ | | "ok 500 ft" |

Volume adjustment

You can adjust the volume for the instructions from the voice command system:



Turn the button during an instruction/announcement to select the desired volume.

Instructions/announcements from the voice command system will continue at this volume level, even if the other audio sources are set to minimum volume.

The system automatically selects your individual volume setting each time you unlock the vehicle using your personal remote control. ◀

Notes

 Do not use the voice command system to make emergency calls. Your voice and habitual tone could be affected by stressful situations, as a result of which the process of establishing the telephone connection could be unnecessarily delayed. Instead, use the emergency call button near the interior rearview mirror, refer to page 177. ◀

Environmental conditions

The voice command system uses a special hands-free microphone located in the front of your vehicle's headliner. Although the system is designed to filter out ambient noise, you can help ensure that your commands will be understood by observing the following instructions:

- ▶ Speak smoothly and clearly, at a normal volume. Do not place any unusual stress on individual syllables, and avoid pauses
- ▶ Do not speak while the voice command system is talking
- ▶ Keep the doors, windows and glass roof closed to prevent interference from ambient noise
- ▶ Avoid other sources of noise in the vehicle while speaking, and ask other vehicle occupants to refrain from talking while you are using the system
- ▶ The hands-free microphone is aimed toward the driver. This means that the system might not be able to register the voices of other vehicle occupants properly.

The notepad

Recording a note

 ›Record note‹.

You can store approx. ten minutes of spoken text, either as a single entry or as multiple entries of any desired length.

To terminate recording:

Press  button for a long period.

 When recording notes, the voice command system does not respond to the ›Cancel‹ command. The text checking function for command words is deactivated in this case so that you can speak any desired text for your notes. This feature saves you from having to concentrate on avoiding any command words. ◀

Listening to a notebook entry

To listen to recorded notebook entries:

-  1. ›Read out‹.
- Approximately the first 3 seconds of the first note are read aloud
2. Following the inquiry ››Note and next?‹‹ select the desired function
- ▶ To listen to the entire note: ›Read out‹
 - ▶ To hear the next notebook entry: ›Next‹
 - ▶ To hear the entry again: ›Back‹ or ›Repeat‹.

Deleting notes

-  1. ›Edit‹
2. ›Delete‹.

Clearing notebook

To delete all contents from the notebook:

-  1. ›Notepad‹
2. ›Delete‹.

Standard commands

The standard commands available for use with all controlled systems are the same.



On delivery, the ›Standard dialog‹ is set to simplify familiarization with the voice command system. ◀

| Function | Command |
|--|-------------------|
| To repeat last message issued by the voice command system | ›Repeat‹ |
| To terminate the voice command system | ›Cancel‹ |
| To set comprehensive instructions and error reports | ›Standard dialog‹ |
| To set brief instructions and error reports | ›Short dialog‹ |
| To call up information on individual items of equipment | ›Help‹ |
| Provides you with a listing of the commands available for the selected system. A corresponding list simultaneously appears in the Info Display, refer to page 27 | ›Options‹ |
| To open the main menu | ›Main menu‹ |

Short commands

Notebook

| Function | Command |
|-----------------------------|-----------------|
| To record a note | ›Record note‹ |
| To listen to notebook entry | ›Read out note‹ |

Navigation

| Function | Command |
|---|----------------------|
| To switch on the voice instructions | ›Message on‹ |
| To switch off the voice instructions | ›Message off‹ |
| To select destination from address book | ›Select destination‹ |
| To change scale | ›Scale‹ |
| To start the destination guidance | ›Route guidance on‹ |
| To call up information on the current position or destination | ›Information‹ |
| To request addresses | ›Address book‹ |
| To open the map view | ›Map‹ |

Entertainment

| Function | Command |
|------------------------------------|-----------------------|
| To switch on radio | ›Radio on‹ |
| To switch off audio sources and TV | ›Audio off‹ |
| To select FM waveband | ›FM‹ |
| To select AM waveband | ›AM‹ |
| To select radio stations | ›Frequency selection‹ |
| To select a stored radio station | ›Station‹ |
| To start CD | ›CD on‹ |
| To select a CD | ›CD 1 ..6‹ |
| To start TV | ›TV on‹ |
| To start DVD | ›DVD on‹ |
| To select a DVD | ›DVD 1 ..6‹ |

Telephone

| Function | Command |
|--|---------------------------|
| To dial telephone number | ›Dial number‹ |
| To redial | ›Redial‹ |
| To select from the phone book | ›Dial name‹ |
| To make a new entry in the phone book | ›Save name‹ |
| To have the entries of the phone book read out | ›Read out telephone book‹ |





Controls

This chapter is intended to provide you with information for complete control of your vehicle. Its extensive array of features and accessories, both for driving and for your own safety, comfort and convenience, are described here.

Opening and closing

Key/remote control



- 1 Remote controls with integrated key. They specify the functions of the Key Memory. Individual functions of your vehicle may behave differently depending on the remote control used. To differentiate, you can mark the remote controls using the color-coded decals you received on taking delivery of the vehicle



There is an extended-life battery in every remote control which is charged automatically in the ignition lock as you drive.

If you have any remote control units that are not being used on a regular basis, you should therefore remember to recharge these units by using them to drive the vehicle for an extended period at least once every six months, also refer to page 36.

With Comfort Access, there is a battery in every remote control. For instructions on changing batteries, refer to page 37. ◀

- 2 Spare key for storage in a safe place, such as in your wallet. This key is not intended for constant use

- 3 Adapter for spare key

The adapter can be used to store the spare key. It can be stored in the place provided within the luggage compartment lid-mounted onboard tool kit to ensure that it will always be available, refer to page 201. You can find more detailed information on using the adapter in the section Using the spare key adapter

Removing key from remote control

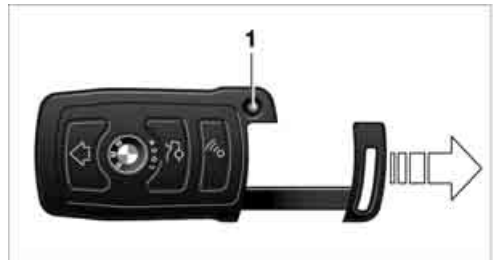

Press button 1 to release the key.

You can use the integrated key to unlock and lock the following:

- ▷ The storage compartment under the front armrest
- ▷ The driver's door
- ▷ The luggage compartment lid.

Within the storage compartment you will also find the switch for locking the luggage compartment separately, refer to page 40.

If you lock the storage compartment and only turn over the remote control, no access is possible via the luggage compartment lid. This is an advantage in a hotel, for example.

Using the spare key adapter

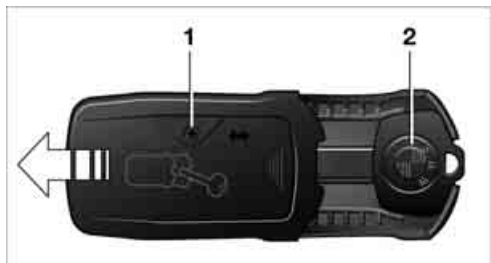

You will need the adapter to activate the ignition and to start the vehicle with the spare key.

Press lock button **1**, slide up the cover and insert the spare key **2** in the adapter. Close the cover and insert the adapter in the ignition lock.

Central locking system

The concept

The central locking system is ready for operation whenever the driver's door is closed. This simultaneously engages and releases the locks on the following:

- ▷ Doors
- ▷ Luggage compartment lid
- ▷ Fuel filler door.

The central locking system can be operated from the outside

- ▷ via the remote control
- ▷ via the driver's door lock
- ▷ with Comfort Access via the door handle

and from inside via the button for the central locking system.

When the system is locked from inside, the fuel filler door remains unlocked. Refer to page 38.

The anti-theft system is automatically activated whenever you activate the central locking system from outside the vehicle. The alarm system is armed/disarmed at the same time.

In an accident, the central locking system automatically unlocks the vehicle. In addition, the hazard warning flashers and interior lamps switch on.

Opening and closing: from outside

Using remote control

When you engage/release the vehicle's locks, you simultaneously activate/deactivate the anti-theft system, arm/disarm the alarm system and switch the interior lamps on/off.

In addition, the remote control offers you another function:

- ▷ Panic mode
In case of danger, you can trigger an alarm.



You can have various confirmation signals programmed into the system to verify that the vehicle has been locked securely. ◀



Protect remote control against unauthorized use, e.g. by handing over only the remote control without an integrated key when leaving the vehicle for valet parking etc., refer to page 34. ◀

For additional details on alarm system, refer to page 42.

Remote control



- 1** Unlock, convenience opening mode and alarm system
- 2** Lock and secure, switch off tilt alarm sensor and interior motion sensor,

switch on interior lamps and door-mounted proximity lamps

- 3 Open luggage compartment lid
- 4 Switch on interior lamps and pathway lighting, activate panic mode

 Because any persons or animals left unattended in a parked vehicle could lock the doors from the inside, you should always keep the remote control with you; this precaution ensures that you will remain able to unlock the vehicle from the outside at all times. ◀

 When it is no longer possible to lock the vehicle via the remote control, the battery is discharged. Use this remote control during an extended drive; this will recharge the battery, refer to page 34. In the event of a system malfunction, please contact your BMW center, which is also your source for replacement keys. ◀

Releasing

Press button 1 .

The interior lamps and the door-mounted proximity lamps come on.

Press the button once to unlock the driver's door only; press a second time to unlock all remaining doors as well as the luggage compartment lid and the fuel filler door.

Convenience opening mode

Briefly press button 1  and then hold down.

The windows and the glass roof open. The glass roof will not be retracted if it is already in its raised position.

Locking and securing

Press button 2  LOCK.

Switching on interior lamps and door-mounted proximity lamps

If the vehicle is locked, press button 2  LOCK.

Switching on interior lamps

Press button 4 .

You can also use this function to locate your vehicle in parking garages etc.

Panic mode*

By pressing and holding button 4  for more than approx. two seconds, you can trigger the alarm system* in response to any impending danger.

To switch off the alarm: press any of the buttons.

Opening luggage compartment lid

Briefly press button 3 .

The luggage compartment lid opens, regardless of whether it was previously locked or unlocked.

 During opening, the luggage compartment lid pivots upward and to the rear. Ensure that adequate clearance is available before opening.

To avoid being inadvertently locked out, never lay the remote control down in the luggage compartment. If the vehicle is locked, the luggage compartment lid is also locked again when closed. ◀

Automatic luggage compartment lid operation*

Opening luggage compartment lid

Briefly press button 3 .

The luggage compartment lid opens all the way, regardless of whether it was previously locked or unlocked.

To interrupt the opening process:

Press the button again while opening is in progress.

 During opening, the luggage compartment lid pivots upward and to the rear. Ensure that adequate clearance is available before opening.

To avoid being inadvertently locked out, never lay the remote control down in the luggage compartment. If the vehicle is locked, the luggage compartment lid is also locked again when closed. ◀

Malfunction

The remote control can be subjected to malfunctions by local radio waves. Should the remote control fail to operate owing to interference of this kind, the vehicle can be opened and closed via the door lock with the integrated key.

When it is no longer possible to lock the vehicle via the remote control, the battery is discharged. Use this remote control during an extended drive; this will recharge the battery, refer to page 34.

Comfort Access*

Carry the remote control on your person if you want to use the Comfort Access.

Unlocking

- ▷ Pull a door handle or
- ▷ press the button on the outside of the luggage compartment lid.

 Only the door of the door handle you have pulled is opened. You unlock the other doors from the inside using the central locking system button, refer to page 38. ◀

Locking and securing

With the driver's door closed, press a door handle.

 You can have various confirmation signals programmed into the system to verify that the vehicle has been locked securely. ◀

 If a remote control is detected in the interior, the vehicle is unlocked again or not locked in the first place. ◀

Opening luggage compartment lid

Press the button on the outside of the luggage compartment lid, refer to page 39.

 During opening, the luggage compartment lid pivots upward and to the rear. Ensure that adequate clearance is available before opening. If a remote control is detected in the luggage compartment after the luggage com-

partment lid has been closed, the luggage compartment lid opens again. ◀

Changing battery

Replace the battery if it is no longer possible to unlock or lock the vehicle.

1. Take the key out of the remote control, refer to page 34
2. Press in the detent, refer to arrow 1, e.g. with the key
3. Remove the cover of the battery compartment, refer to arrow 2



4. Insert a battery of the same type with the positive side facing upwards
5. Press the cover to close it.

 Return used batteries to a recycling point or your BMW center. ◀

For US owners only

The transmitter and receiver units comply with part 15 of the FCC/Federal Communication Commission regulations. Operation is governed by the following:

FCC ID: LX8766S
LX8766E
LX8CAS
LX8CAS2

Compliance statement:

This device complies with part 15 of the FCC Rules. Operation is subject to the following two conditions:

- ▷ This device may not cause harmful interference, and
- ▷ this device must accept any interference received, including interference that may cause undesired operation.

 Any unauthorized modifications or changes to these devices could void the user's authority to operate this equipment. ◀

Using key

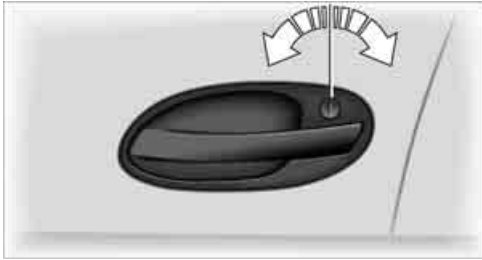

One turn of the key in the driver's door lock unlocks the driver's door only. Turning the key a second time unlocks all of the remaining doors, the luggage compartment lid and the fuel filler door.

 You can have various confirmation signals programmed into the system to verify that the vehicle has been locked securely. ◀

Convenience operation

You also have the option of operating the windows and the glass roof from the driver's door lock.

- ▷ To open:
With the door closed, turn the key to the 'Unlock' position and hold it there
- ▷ To close:
With the door closed, turn the key to the 'Lock' position and hold it there.



 Watch during the closing process to be sure that no one is injured. Releasing the key stops the operation. ◀

Manual operation



If an electrical defect occurs, you can unlock or lock the driver's door with the key in the end positions of the door lock.

Opening and closing: from inside



You can operate the central locking system with this button when the driver's door is closed. The doors and luggage compartment lid are unlocked  or locked  only. The anti-theft alarm system is not activated.

Also, the fuel filler door remains unlocked to allow refueling.

 If the remote control, refer to page 36, or Comfort Access, refer to page 37, have been used to unlock only the driver's door and you press the  button when the driver's door is open, the other doors, the luggage compartment lid, and the fuel filler door are unlocked. If the driver's door is closed, pressing the  button locks it. ◀

 You can also have the system programmed to activate the central locking system automatically whenever the vehicle is set in motion, or when a specific interval elapses after it is unlocked, provided that neither the doors nor the luggage compartment lid are opened in the meantime. This can be adjusted to be key-specific. ◀

Unlocking and opening doors

- ▷ Either unlock the doors together with the button for the central locking system and then pull the release handle above the armrest or
- ▷ pull the release handle for each door twice: the first pull unlocks the door, and the second one opens it.

 When the low beams are switched on, the interior door handles are also lighted. The intensity of the lighting is adjusted using the instrument lighting control, refer to page 101. ◀

Engaging locks

- ▶ Use the central locking button to lock all of the doors simultaneously, or
- ▶ press the individual safety lock buttons down. To prevent the driver from being inadvertently locked out of the vehicle, the lock button on the driver's door automatically extends again after a brief period if the door remains open.

 Because any persons or animals left unattended in a parked vehicle could lock the doors from the inside, you should always keep the remote control with you; this precaution ensures that you will remain able to unlock the vehicle from the outside at all times. ◀

Doors

Automatic soft closing*

Apply gentle pressure to the door to close it. The closing process will then be carried out automatically.

 To avoid injuries, ensure that the door's travel path is completely free and clear before closing. ◀

Luggage compartment lid

Opening from outside

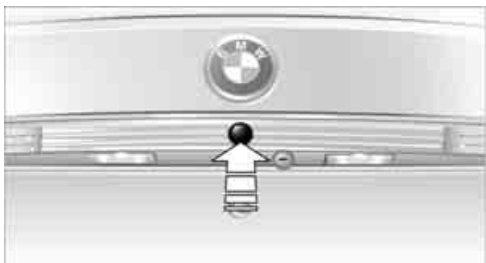

Press button. The luggage compartment lid opens.

 During opening, the luggage compartment lid pivots upward and to the rear. Ensure that adequate clearance is available before opening. ◀

The lock

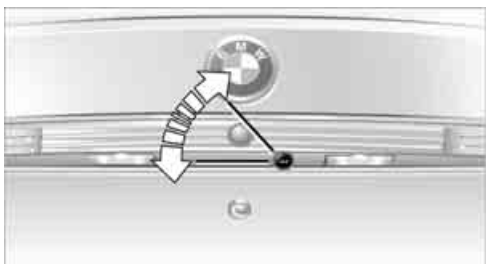

All of the vehicle's keys fit the luggage compartment lid lock located in the license plate recess.

Opening separately

Insert the key in the luggage compartment lid's lock and turn it all the way to the right – the lid opens.

 To avoid being locked out inadvertently, avoid laying the remote control down in the luggage compartment. The luggage compartment is locked again as soon as you close the lid.

If you use the key to unlock the luggage compartment lid while the alarm system is armed, the alarm will be triggered. Switching off the alarm, refer to page 42. ◀

Locking separately

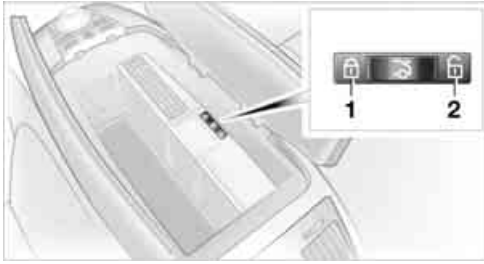

The switch position will vary according to the individual vehicle's equipment level.

- 1 Luggage compartment lid locked
- 2 Luggage compartment lid unlocked

Push the switch into position **1**. This locks the luggage compartment lid and disconnects it from the central locking system.

If you then lock the storage compartment in the center armrest before handing over only the remote control when leaving the vehicle for valet parking, etc., this will prevent unauthorized access to the vehicle through the luggage compartment, refer to page 34. This is an advantage in a hotel, for example.

Manual operation

If an electrical defect occurs, refer to Opening separately.

Opening from inside



You can use this button to open the luggage compartment lid when the vehicle is stationary. This is not possible, if the luggage compartment lid has been locked separately.

Closing



A recess has been incorporated into the inside trim on the luggage compartment lid to make it easier to pull down.

Comfort Access*

▶ If a remote control is detected in the luggage compartment after the luggage compartment lid has been closed, the luggage compartment lid opens automatically.

During opening the luggage compartment lid pivots upward and to the rear. Ensure that adequate clearance is available before opening. ◀

Automatic soft closing

To close the luggage compartment lid, merely press it down gently. The closing process will then be carried out automatically.

⚠ To avoid personal injury, always ensure that no individuals are within the luggage compartment lid's travel range when closing. ◀

⚠ Operate the vehicle only when the luggage compartment lid is completely closed. Otherwise, exhaust fumes could penetrate the interior of the vehicle. ◀

If special circumstances should make it absolutely necessary to operate the vehicle with the luggage compartment lid open:

- ▶ Close all windows and the glass roof
- ▶ Adjust the automatic climate control's blower to supply a high rate of airflow, refer to page 105.

Automatic luggage compartment lid operation*

Opening

The luggage compartment lid opens all the way, when you

- ▷ press the button next to the steering column
- ▷ press the button on the outside of the luggage compartment lid, refer to page 39
- ▷ press button **3**  on the remote control, refer to page 36.

 During opening, the luggage compartment lid pivots upward and to the rear. Ensure that adequate clearance is available before opening. ◀

Closing



The luggage compartment lid closes automatically when you

- ▷ press the button or
- ▷ press the button on the outside of the luggage compartment lid, refer to page 39.

 The luggage compartment lid immediately stops opening or closing if you hold it in place by hand. ◀

 To avoid injuries, be sure that the travel path of the luggage compartment lid is clear when it is closed, as with all closing procedures. Operate the vehicle only when the luggage compartment lid is completely closed. Otherwise, exhaust fumes could penetrate the interior of the vehicle. If special circumstances should make it absolutely neces-

sary to operate the vehicle with the luggage compartment lid open:

- ▷ Close all windows and the glass roof
- ▷ Adjust the automatic climate control's blower to supply a high rate of airflow, refer to page 105. ◀



Automatic closing of the luggage compartment lid is not activated in your vehicle. If you desire, you can have this function set. ◀

Comfort Access*

 If a remote control is detected in the luggage compartment after the luggage compartment lid has been closed, the luggage compartment lid opens automatically.

During opening the luggage compartment lid pivots upward and to the rear. Ensure that adequate clearance is available before opening. ◀

Manual operation

In the case of an electrical defect, you can unlock the luggage compartment lid with the key, refer to page 39, and slowly open and close it without sudden movements.

Emergency release



This lever releases the luggage compartment lid from inside the luggage compartment.

Luggage compartment

Net*

You can use the net to store smaller objects on the bulkhead separating the luggage compartment from the rear seats.

 Do not stow objects behind the side trim panels on the left and right in the luggage compartment, as otherwise the electrical parts could overheat and be damaged. ◀

Alarm system

The concept

The vehicle alarm system responds:

- ▷ When a door, the hood, or the luggage compartment lid is opened
- ▷ To movement in the vehicle interior: interior motion sensor
- ▷ To changing the vehicle's tilt if someone attempts to steal the wheels or tow the vehicle
- ▷ To interruption of battery voltage.

The system responds to unauthorized vehicle entry and attempted theft by simultaneously activating:

- ▷ An acoustic alarm, which lasts for a period of approx. 30 seconds
- ▷ The hazard warning flashers for approx. five minutes
- ▷ The high beams, which flash on and off in the same rhythm.

Arming and disarming alarm system

When you lock or unlock the vehicle, either with the remote control or at the door lock, the alarm system is armed or disarmed at the same time.

The system indicates that it has been correctly armed by switching on the hazard warning flashers for a single cycle and by emitting an acoustic signal.



You can have different acknowledgment signals set to confirm arming and disarming. ◀

You can also open the luggage compartment lid with the system armed using button **3**  on the remote control, refer to page **36**. When you close the lid, the system is rearmed.



Unlocking via the door lock will trigger the alarm on some national-market versions.

Pressing the 'Panic mode' button for a longer period also triggers the alarm, refer to page **36**. ◀

Switching off alarm

- ▷ Unlock the vehicle using the remote control, refer to page **36**
- ▷ or insert the remote control all the way into the ignition lock, engaging the detent.

Indicator lamp displays



- ▷ The indicator lamp below the interior rearview mirror flashes continuously: the system is armed
- ▷ The indicator lamp flashes when the system is vehicle is locked: door(s) or tailgate are not completely closed. Even if you do not close the alerted area, the system begins to monitor the remaining areas, and the indicator lamp flashes continuously after 10 seconds. However, the interior motion sensor is not activated
- ▷ The indicator lamp goes out when the vehicle is unlocked: no manipulation or attempted intrusions have been

detected in the period since the system was armed

- ▶ If the indicator lamp flashes after you unlock the vehicle before the remote control is inserted in the ignition lock, but for no more than roughly 5 minutes: an attempted entry has been detected in the period since the system was armed.

Following triggering of an alarm, the indicator lamp will flash continuously.

Tilt alarm sensor and interior motion sensor

Tilt alarm sensor

The tilt of the vehicle is monitored. The alarm system reacts, e.g. in case of an attempted wheel theft or towing.

Interior motion sensor

In order for the interior motion sensor to function properly, the windows and glass roof must be completely closed.

Avoiding unintentional alarms

The tilt alarm sensor and interior motion sensor may be switched off at the same time. This prevents unintentional alarms, e.g. in the following situations:

- ▶ In duplex garages
- ▶ When transporting on car-carrying trains
- ▶ When animals are to remain in the vehicle.

Switching off tilt alarm sensor and interior motion sensor

Press button **2**  **LOCK** on the remote control twice consecutively.

The indicator lamp lights up briefly and then flashes continuously. The tilt alarm sensor and the interior motion sensor are switched off up to the next unlocking and locking actions.



If you wish, the tilt alarm sensor and interior motion sensor will be permanently deactivated. Please contact your BMW center for assistance. ◀

Windows

Opening and closing windows



From radio mode on:

- ▶ Press the switch up to the resistance point:
The window continues to move downward as long as you continue to hold the switch
- ▶ Briefly press the switch beyond the resistance point:
The window moves downward automatically. Briefly press the switch again to stop the opening movement.

You can close the windows in the same manner by pulling the switch.

After switching off ignition

You can still operate the power windows:

- ▶ For approx. 15 minutes with the remote control in the radio mode
- ▶ For approx. 1 minute in position 0 or with the remote control disengaged.

To open, press the switch beyond the resistance point.



When leaving the vehicle parked, remove the remote control from the ignition lock and close the doors; this precaution prevents children from operating the power windows and injuring themselves etc. ◀

For information on using the convenience operation at the door lock or with the remote control, refer to page 36 or 38.

Anti-trapping mechanism

If the force rises beyond a predefined threshold during closing, the system will stop moving the window prior to lowering it slightly.

 Despite the anti-trapping mechanism you should inspect the window's travel path prior to closing it, as the safety system might fail to detect certain kinds of obstructions, such as very thin objects, and the window would continue closing.

The protection provided by the anti-trapping mechanism is limited when the switch is pulled beyond the resistance point and held. Under these conditions the window will respond to forces beyond a defined threshold by only opening several millimeters.

If you again pull the switch beyond the resistance point and hold it in position within a period of roughly 4 seconds, this anti-trapping mechanism will be deactivated. ◀

 When you close the windows they will slow down as they approach the end of their travel; this is to allow the anti-trapping mechanism to respond more precisely to any obstructions encountered in this critical range. ◀

Safety switch



With the safety switch, you can prevent the rear windows from being opened or closed via the switches in the rear passenger area, by children, for example. The same applies to adjusting the electric rear seats, refer to

page 48 and the electric rear head restraints, refer to page 50, as well as to the operation of the roller sun blinds from the rear, refer to page 113. The indicator lamp lights up when this safety feature is activated.

 Press the safety switch when children ride in the rear, as otherwise unchecked closing of the windows could lead to injuries. ◀

 So that you can deactivate the function again, the remote control must be inserted in the ignition lock or, with Comfort Access, the radio mode must be switched on. ◀

After installing accessories

After installing any accessory – such as a clamp-on antenna for a portable phone – within the window's travel range, you will need to have the system reinitialized for use under the new conditions. BMW recommends having this work carried out by your BMW center.

Glass roof, electric*

Raising, opening, closing

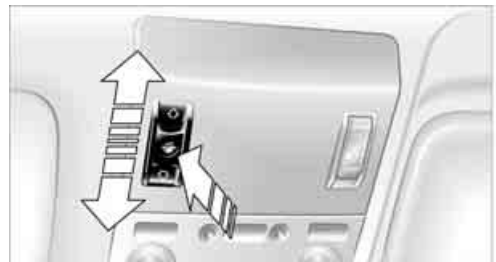

From radio mode on, press the switch, or slide it in the desired direction up to the resistance point.

After switching off ignition

You can still operate the roof:

- ▷ In the radio mode for a longer time
- ▷ For approx. 1 minute in position 0 or with the remote control disengaged.

The headliner insert slides back somewhat when you raise the roof. When the roof is opened the headliner retracts with it.

⚠ Do not use force to close the headliner insert with the roof in its raised position, as damage to the mechanism could result. When leaving the vehicle, disengage the remote control in the ignition lock and close the doors, as otherwise children could operate the roof and injure themselves etc. ◀

For information on using the convenience operation at the door lock or with the remote control, refer to page 36 or 38.

Automatic* opening and closing

Briefly press the switch beyond the resistance point and then release it.

In addition, the following response is also automatic:

With the roof open, briefly press the switch in the 'Raise' direction: the roof rises to its tilt-up end position.

Press the switch again in any direction to stop the roof.

Anti-trapping mechanism

If the glass roof meets with resistance during closing from approximately the middle of the roof opening or when closing from the raised position, then the closing operation is interrupted and the glass roof opens again somewhat.

⚠ Despite the anti-trapping mechanism inspect the roof's travel path prior to closing it, as the safety system might fail to detect certain kinds of obstructions, such as very thin objects, and the roof would continue closing.

The protection provided by the anti-trapping mechanism is limited when the switch is pressed beyond the resistance point and held. The roof only opens a short distance. If you again press the switch beyond the resistance point and hold it in position within a period of roughly 2 seconds, the anti-trapping mechanism will be deactivated. ◀

▶ When you close the glass roof, it will slow down as it approaches the end of its travel path; this is to allow the safety feature to respond more precisely to any obstructions encountered in this critical range. ◀

Following interruptions in electrical power supply

Following interruptions in electrical power, for instance, when the battery is disconnected, it is possible that the glass roof will extend to its tilt-up position, but fail to respond to other commands. The system must be initialized. BMW recommends having this work carried out by your BMW center.

Malfunction

In the event of an electrical defect, you can operate the glass roof manually:

1. Take out the interior lamp, reach behind the opening, press out the cover

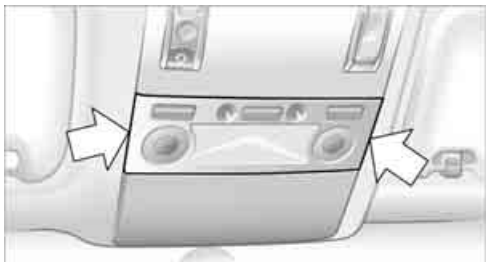

2. Insert the Allen wrench supplied with the onboard tool kit, refer to page 201, in the opening provided. Turn to slide the glass roof in the desired direction.



Adjustments

Sitting safely

The ideal sitting position can make a vital contribution to relaxed driving that is as fatigue-free as possible. The sitting position plays an important role together with the safety belts and airbags in an accident. To ensure that the safety systems operate with optimized efficiency, we strongly urge you to observe the instructions contained in the following section.

For additional information on transporting children safely, refer to page [58](#).

Sitting safely with airbags

 Always maintain an adequate distance between yourself and the airbags. Always hold the steering wheel by its rim with hands at the 9 o'clock and 3 o'clock positions, to minimize the risk of injuries to your hands and arms in the event of airbag deployment.

No one and nothing is to come between the airbags and the seat occupant.

Do not use the cover of the front airbag on the front passenger side as a storage area. Make sure that the front passenger is correctly seated and does not rest feet or legs on the instrument panel, otherwise leg injuries can occur if the knee and front airbag are triggered.

Never let an occupant's head rest near or on a side airbag because the inflating airbag could cause a serious or fatal injury. ◀

Even if you adhere to all the instructions, injuries resulting from contact with airbags cannot be fully excluded, depending on the circumstances. The ignition and inflation noise may provoke a mild – usually temporary – hearing loss in extremely sensitive individuals.

For airbag locations and additional information on airbags, refer to page [98](#).

Sitting safely with safety belts

Even though there is an airbag, wear a safety belt every time you get in the vehicle. Although airbags enhance safety by providing added protection, they are not a substitute for safety belts.

Your vehicle has five seats that are all equipped with a safety belt.

 At all times, occupants should sit upright and be properly restrained, infants and small children in appropriate child-restraint systems; larger children and adults using the safety belts.

Expectant mothers should always wear their safety belts, taking care to position the lap belt against the lower hips, where it will not exert pressure against the abdominal area.

Never allow more than one person to wear a single safety belt. Never allow infants or small children to ride in a passenger's lap. Do not route the belt across your neck, or run it across sharp edges. Be sure that the belt does not become caught or jammed. Avoid twisting the belt while routing it firmly across the hips and shoulder. Do not allow the belt to rest against hard or fragile objects. Otherwise, in the event of a frontal impact, a loose lap belt could slide over your hips, leading to abdominal injury. Avoid wearing clothing that prevents the belt from fitting properly and pull the lap belt periodically to readjust the tension across your shoulder in order to avoid a reduction in the retention effect of the safety belt. ◀

For instructions on operating safety belts, refer to page [51](#).

Seats

Note before adjusting

⚠ Never attempt to adjust your seat while operating the vehicle. The seat could respond with unexpected movement, and the ensuing loss of vehicle control could lead to an accident.

Also on the passenger's side, do not incline the backrest too far to the rear while the vehicle is being driven, as otherwise there is a danger in the event of an accident of 'sliding under' the safety belt, eliminating the protection normally provided by the belt. ◀

Please observe the information on damage to safety belts provided on page 51 and the information on the active head restraints on page 49.

The concept



You adjust the seat in two stages:

- 1 Preselect the function: the button lights up brightly
- 2 Adjustments: slide control knob to
 - ▷ front or rear ◀▶ or
 - ▷ upwards or downwards ▲▼
 - ▷ or turn ▶◀

Power seat adjustment

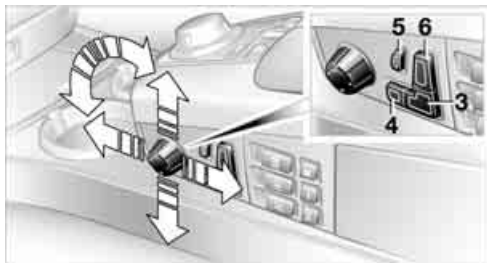

You can use the control knob to adjust various functions after first selecting them with the buttons.

⚠ To ensure that the safety systems continue to provide optimized protection, please observe the adjustment instructions on page 47. ◀

- 3 Longitudinal direction: ◀▶
Height: ▲▼
Backrest: ▶◀
This button is normally active
- 4 Thigh support: ◀▶
Height: ▲▼
Tilt angle: ▶◀
- 5 Lumbar support*, refer to next column
- 6 Height of the head restraint: ▲▼

Front comfort seat* adjustment

In addition to the power seat functions, several other adjustment options are also available with the comfort seat:

- 4 Thigh support: ◀▶
Tilt angle: ▶◀
- 5 Lumbar support, see below
Backrest width:
Increase or decrease lateral support ▶◀
- 6 Shoulder support, see below
Height of the head restraint: ▲▼
Backrest: ▶◀

Automatic backrest width adjustment

The backrest automatically moves to the widest possible position to ease driver entry and exit before then returning to the

standard position or stored memory setting.

This automatic system is influenced on both seats by each door as well as on the driver's seat by the ignition and on the front passenger's seat by the safety belt buckle.

Sports seat* adjustment

In addition to the power seat functions, several other adjustment options are also available with the sports seat:

- 4 Thigh support: ◀▶
- 6 Height of the head restraint: ▲▼

Lumbar support adjustment

5 Lumbar support

You can also adjust the contours of the backrest to obtain additional support in the lumbar region.

The upper hips and spinal column receive supplementary support to help you maintain a relaxed, upright sitting position.

- ▶ ◀▶ Press front or rear:
Increase or decrease curvature
- ▶ ▲▼ Press top or bottom:
Extend curvature upward or downward.

Shoulder support adjustment

- 6 Adjust the tilt angle of the shoulder support: ◀▶

You can use the adjustable upper backrest for supplementary support in the shoulder region. This provides a relaxed driving position and helps relieve stress on the shoulder muscles.

⚠ Make corrections in the forward/backward adjustment of the seat to ensure that the safety belt still fits firmly against your body. If you do not do this, the protection provided by the safety belt may be reduced. ◀

Rear comfort seat* adjustment

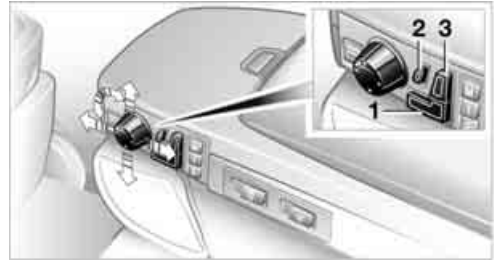

You can use the control knob to adjust various functions after first selecting them with the buttons.

- 1 Longitudinal direction: ◀▶
Tilt angle: ▲▼
Backrest: ▶▶
This button is normally active
- 2 Lumbar support, refer to page 48
- 3 Shoulder support: ◀▶
Height of the head restraint: ▲▼
Backrest: ▶▶

▶ It is not possible to adjust the comfort seats if the safety switch for the power windows has been pressed, refer to page 44. ◀

Adjusting passenger seat from rear

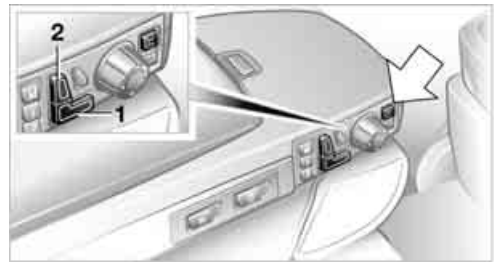

The front passenger's seat can be adjusted from the rear sitting positions, for instance, when a rear passenger desires more legroom.

Press the button to activate this function, refer to arrow.

You can use the control knob to adjust the settings after selecting the desired function with the buttons.

- 1 Longitudinal direction: ◀▶
Height: ▲▼
Backrest: ▶◀
- 2 Height of the head restraint: ▲▼
Press the button again, refer to arrow, to deactivate this function.

Resetting to standard adjustment position

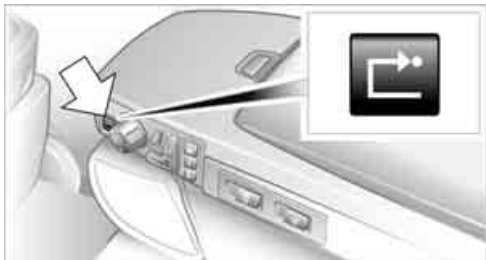

You can use the button to return the rear seats to their standard or default positions. Maintain pressure on the button until the system completes the adjustment.

▶ It will be necessary to return the rear seats to their standard position before using a child-restraint system, for instance, refer to page 58. ◀

Head restraints

Adjustment information

⚠ Head restraints reduce the risk of spinal injury in the event of an accident. Adjust the head restraints so that they are centered roughly at the level of your ears. ◀

Height adjustment

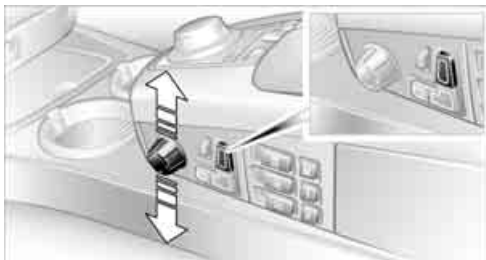

▲▼ Set the height of the head restraint.

Tilt angle adjustment



Swivel the head restraint.

▶ With the comfort seat, adjust the distance to the back of the head via the shoulder support. ◀

Side extensions adjustment



You can fold the side extensions on the head restraint forward for increased lateral support.

Front head restraints, active*

The front comfort seats are equipped with an active head restraint.

When necessary, the system will respond to a rear impact by automatically triggering the active head restraints.

⚠ To ensure that the active head restraints afford maximum protection, and to avoid unnecessary risks to personal safety, we request that you read and comply with the following.

- ▶ Adjust the head restraints so that they are centered at roughly ear height
- ▶ Do not install seat or head-restraint covers
- ▶ Never use the head restraints as supports for suspending objects of any

kind, such as clothes hangers. Refrain from mounting accessories on either the seat or the head restraint. ◀

Rear seats

Adjusting mechanically

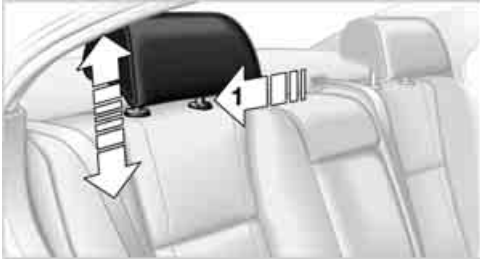

- ▷ To raise: pull
- ▷ To lower: press the button, arrow 1, and push down the head restraint.

To remove head restraints, refer to page 50.

Center head restraint adjustment

! If the head restraint has been lowered, pull it back up, continuing until the detent engages, before allowing a passenger to ride in the rear center position. Otherwise the level of occupant protection can be reduced. ◀

Adjusting electrically*

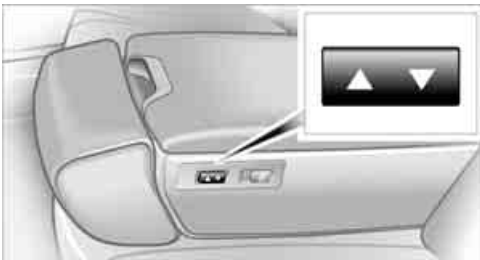

If necessary, adjust the head restraint's height to ensure that it is centered at roughly the height of the passenger's ears.

▷ With the safety switch pressed, refer to page 44, the height adjustment of the head restraints is deactivated. ◀

The head restraints at the outer sitting positions extend automatically whenever the system detects a passenger on the seat. You can also adjust the height of the head restraint electrically.

! To prevent possible personal injury and property damage, always ensure that the area above the head restraints is clear and unobstructed before extending them upward. ◀

Manual head restraint removal and installation



Removal

1. Pull the head restraint upward to the stop
2. Press the button, arrow 1, and remove the head restraint.

Installation

1. Press the button, arrow 1, and slide the head restraint into its support
2. Adjust the head restraint for your personal comfort.

Rear comfort seat*

Height adjustment

If necessary, adjust the head restraint's height to ensure that it is centered at roughly the height of the passenger's ears.

▷ With the safety switch pressed, refer to page 44, the height adjustment of the head restraints is deactivated. ◀

The head restraints at the outer sitting positions extend automatically whenever the system detects a passenger on the seat.

You can also adjust the height of the head restraint electrically.

 To prevent possible personal injury and property damage, always ensure that the area above the head restraints is clear and unobstructed before extending them upward. ◀

Side extensions adjustment



You can fold the side extensions on the head restraint forward to increase lateral support.

Safety belts



Fastening

Make sure you hear the latch plate engage in the belt buckle.



The warning lamp lights up after driving a short distance until after the driver and front passenger have fastened their safety belts.

At the same time, an acoustic signal sounds. The warning lamp also lights up and a signal sounds if the driver or front passenger removes the safety belt during driving.



The warning lamp can light up and a signal can sound if objects are laid on the front passenger's seat. ◀

Releasing

1. Press the red button in the belt buckle
2. Hold the belt firmly
3. Guide the belt back into its reel.

The shoulder strap's anchorage point will be in the correct position for seat occupants of every build if the seat is correctly adjusted, refer to page 47.

The two rear safety belt buckles integrated in the rear seat are for passengers sitting on the left and right. The belt buckle embossed with the word CENTER is intended exclusively for use by passengers riding in the center position.

Damage to safety belts



In the event of loads caused by accidents or other damage: have the belt system including the belt tensioner and any child restraint systems replaced and the anchorage points checked. Only have corresponding work carried out by a BMW center or a workshop that uses personnel trained in accordance with BMW requirements. ◀

Rear seats



When the rear center position is not occupied, the latch on the safety belt can be inserted in the slot between the seat's upholstery and the backrest. ◀

Heated seats*

Front



The system regulates the temperatures of the seat cushion and backrest.

The temperature setting progresses one step through its control sequence each time you press the button.

To switch off:

Maintain pressure on the button for several seconds.

Rear

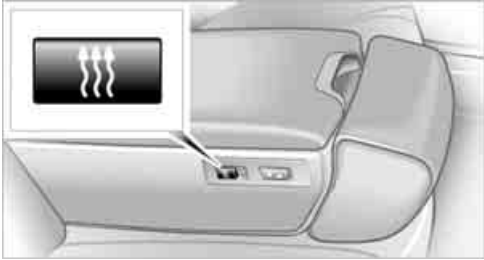

The operating concept is the same as for the front heated seats.

Temperature distribution at front

It is possible to select a temperature-distribution pattern providing different levels of heating for the seat cushion and the backrest, for instance, to adapt for different clothing on the legs and upper body.

1. Select "Climate"
2. Select  and confirm your selection
3. Select "Seat temp." and confirm your selection
4. Select "Left" or "Right" and confirm your selection

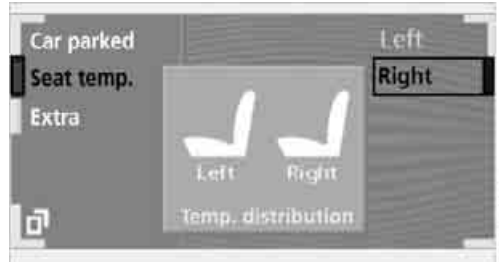

5. Turn to adjust temperature distribution
6. Press to confirm your entry.

 The system automatically selects your individual temperature distribution settings each time you unlock the vehicle using your personal remote control. ◀

Active seat ventilation*



Front

The system progresses one step through the control sequence each time you press the button.

To switch off:

Maintain pressure on the button for several seconds.

 Use level 3 to cool the passenger compartment rapidly, for instance, when heat accumulates in the vehicle. The system automatically reverts to operation at level 2 after a brief period. ◀

Rear



The operating concept is the same as for the front seat ventilation.

Active seat for driver*



Active adjustment of the seat cushion's contours reduces muscular tension and fatigue to help prevent lower back pain.

To activate: press the button, the indicator lamp comes on.

Mirrors

Adjusting exterior mirrors



- 1 4-way adjustment
- 2 Selecting mirror for adjustment

! To prevent the exterior mirrors on this vehicle from being damaged, always fold them in by hand before entering an automatic car wash. ◀

You can also adjust the mirrors manually by pressing against the outer edges of their lenses.

Storing the mirror positions, refer to Seat, mirror and steering wheel memory on page 55.

! The mirror on the passenger's side features a lens with a more convex surface than the mirror installed on the driver's side. When estimating the distance between yourself and other traffic, bear in mind that the objects reflected in the mirror are closer than they appear. This means that estimations of the distance to following traffic should not be regarded as precise. ◀

Self-defrosting mirrors

The mirrors are automatically heated whenever the ignition is switched on.

Interior and exterior mirrors, automatic dimming feature*

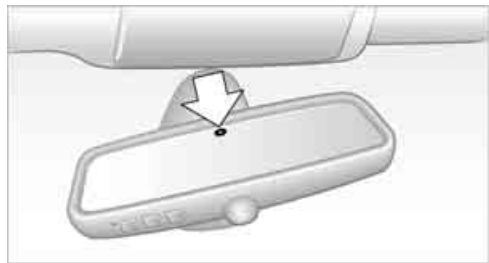

These mirrors dim steplessly during forward driving when struck by light. There are two photocells located in the interior rearview mirror for this purpose. One is integrated within the mirror's lens, refer to arrow, while the other is located at an offset position on the rear of the mirror housing.

For trouble-free operation, keep the photocells clean and do not cover the area between the interior rearview mirror and the windshield. Do not attach any kind of stickers on the windshield in front of the mirror, either.

The mirrors automatically revert to their clear, undimmed mode whenever you engage transmission position R.

Illuminated vanity mirror in rear

1. Press button **1**. The vanity mirror folds down
2. Pull the mirror slightly downwards before you swivel it

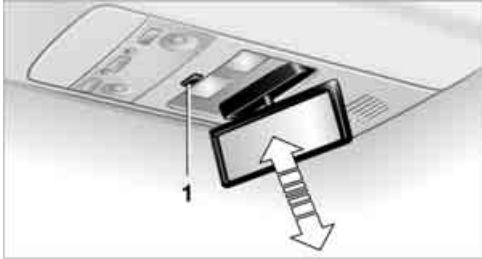

3. Press the vanity mirror back up before folding it back in.

Steering wheel adjustment



The steering wheel can be adjusted in any of four directions by pressing the appropriate end of the button.

⚠ Do not adjust the steering wheel while the vehicle is moving. There is a risk of accident from unexpected movement. ◀

Storing steering wheel positions, refer to Seat, mirror and steering wheel memory on page 55.

Automatic steering wheel adjustment

The steering wheel automatically moves as high up and far forward as possible to ease

driver entry and exit before then returning to the standard position or stored memory setting.

This automatic feature is governed by the driver's door and the ignition switch.

Steering wheel heater*



The steering wheel heater operates when the ignition is on.

Press the button to activate or deactivate this system.

The indicator lamp within the button lights up when the steering wheel heater is in operation.

Programming button function

✦ You can assign specific individual functions to the programmable button. This feature then provides you with quick access to this function, allowing you to control it without undue distraction from road and traffic conditions.

1. Select "Settings"
2. Confirm
3. Select "✦ button". Continue to press the controller until the desired function appears:
 - ▷ "Recirc. air"
In this mode the supply of outside air remains blocked, refer to AUC Automatic recirculated-air control on page 105
 - ▷ "Navi info."
To repeat the most recent message from the navigation system, refer to page 141
 - ▷ "AUTO P"
To activate/deactivate Automatic

Hold refer to Automatic Hold on page 65.

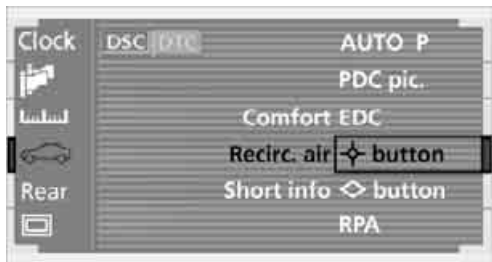

You can select the displayed function using the button on the steering wheel.

 If you have activated the Automatic Hold feature, refer to page 65, you can use the button on the steering wheel to deactivate the system for parking maneuvers etc. ◀

Seat, mirror and steering wheel memory

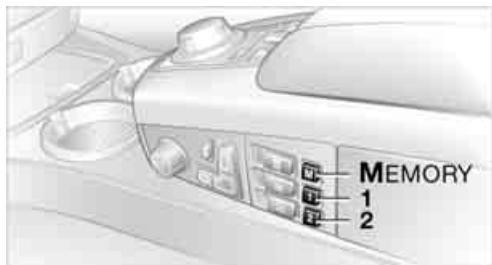

You can store and select two different adjustment settings for the driver's seat, exterior mirrors and steering wheel.

If your vehicle is equipped with comfort seats, you can also store and set two sitting positions for each additional seat with the memory.

The adjustment of the lumbar support is not stored in the memory.

Storing

1. Radio mode, or switch on ignition
2. Set desired sitting position; for driver's seat also the exterior mirror and steering wheel position

3. Press **MEMORY** button:
The indicator lamp within the button comes on
4. Press the desired memory button **1** or **2**:
The indicator lamp goes out.

Selecting a stored setting

Convenience mode

1. Driver's door open after unlocking or ignition lock in radio mode
2. Briefly press the desired memory button **1** or **2**.

The system immediately cancels the adjustment procedure when you press one of the seat adjustment buttons or use one of the memory buttons.

Safety feature

1. Driver's door closed and ignition switched either on or off
2. Press memory button **1** or **2** and maintain pressure until the adjustment process has been completed.

If you press the **MEMORY** button accidentally:

Press the button again; the indicator lamp goes out.

 Do not call up a position from the memory while the vehicle is moving. There is a risk of accident from unexpected movement of the seat or steering wheel. ◀

 You can have your vehicle programmed to automatically dial in your own individual adjustment settings for the seat, mirrors and steering wheel whenever you use your personal remote control to unlock the vehicle. ◀

 When using the Key Memory feature always make sure that the footwell behind the driver's seat is empty and unobstructed. If you fail to do so, any persons or objects behind the seat could be injured or damaged by a rearward movement of the seat. ◀

Tilt function, passenger-side mirror

Automatic curb monitor



Activating

1. Select the driver's mirror with the mirror selector switch
2. When you select the transmission position R, the exterior mirror glass on the front passenger side tilts downward slightly. This allows the driver to see the area immediately adjacent to the vehicle – such as a curb – when parking, etc.

Deactivating

Slide the mirror selection switch to the passenger's side position.

Vehicle Memory, Key Memory

How the system functions

Doubtless you have often reflected on how great it would be if you could configure your vehicle's various adjustment settings to meet your own personal requirements. In developing your vehicle, BMW has incorporated a number of options for personal adjustment which you can set with the Control Center or you can have these programmed at your BMW center.

There are vehicle-related and person-related adjustments: Vehicle Memory and Key Memory. You can have up to four different basic settings adjusted for four different persons. The only requirement is that each person uses his or her own remote control.

When your vehicle is unlocked with the remote control, the vehicle recognizes the individual user by means of a data exchange with the key, and makes adjustments accordingly.

To differentiate

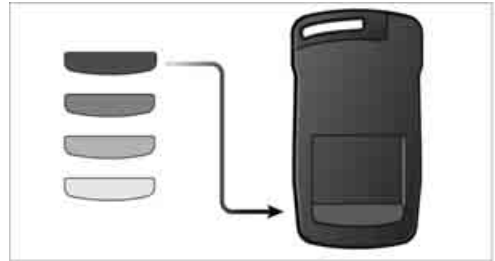

Color-coded decals are provided to help you distinguish the individual remote controls with their different settings.

What the system can do

Please contact your BMW center for more information on the range of options available with Vehicle Memory and Key Memory.



You will see this symbol throughout the Owner's Manual. It is to remind you at appropriate places of the settings that are available to you. These positions can be looked up in the index under the respective keyword. ◀



Following configuration of the memory functions, vehicle operation may differ from the description in the Owner's Manual. Should you want to sell your BMW some day, please remember to have the memory functions reset to the default state. ◀

Examples of Vehicle Memory functions

- ▷ Central locking system: set different signals as an acknowledgment
- ▷ Pathway lighting: deactivate/activate function and set times
- ▷ Daytime driving lamps: activate/deactivate function

- ▷ Alarm system: set different acknowledgment signals to confirm arming/disarming
- ▷ Alarm system: activate/deactivate interior motion sensor and tilt alarm sensor
- ▷ Automatic headlamp control: adjust sensitivity.

Examples of Key Memory functions

- ▷ Seat memory: activate/deactivate function
- ▷ Central locking system: vehicle is locked as soon as you drive off or if you have not opened a door or the luggage compartment lid after unlocking. Activate/deactivate function
- ▷ Automatic climate control: key-specific storage of the temperature, fan and air conditioner setting. Activate/deactivate function
- ▷ Check Control: set languages and units
- ▷ Seat heating: recall personal temperature distribution.

Transporting children safely

The right place for children

Children always in the rear

Accident research shows that the safest place for children in a vehicle is in the rear seat.

Older children should be tightly secured with a safety belt, after they have outgrown a booster seat that is appropriate for their age, height and weight.

 A child sitting in the rear seat and not properly restrained may place his or her head on or near the airbag, if so equipped. For example, a child, even though belted, may fall asleep with his or her head against the side airbag. It may be difficult for a driver to ensure that children in the rear seat will remain properly positioned at all times and do not place their heads on or near the side airbags. Therefore, we recommend that the rear side airbags, if provided, be deactivated if you plan to transport children in the rear seat. ◀

Child-restraint system in the rear

 Children under 13 years of age and children less than 5 ft/150 cm tall should always ride in the rear and the restraint systems should be secured with the vehicle's safety belts. ◀

Younger children should be secured in an appropriate forward-facing child-restraint system that has first been properly restrained. We strongly urge you to carefully read and comply with the instructions for installation and use provided by the child restraint's manufacturer whenever you use such a device.

All rear sitting positions in your vehicle meet the recommendations of SAE J1819, an industry-recommended practice for securing child-restraint systems in motor vehicles.

Exception for front passenger seat

 Should it become necessary to use a child-restraint system on the front passenger seat, the airbags on the passenger's side must be deactivated. The passenger airbag indicator lamp above the interior rearview mirror must light up continuously. Otherwise, the front passenger airbags remain active and there is considerable risk of injury to children if the airbags are triggered, even with a child-restraint system. In this case, children should be seated in the rear and the system should be checked at your BMW center. ◀

 Never install a rearward-facing child-restraint system in the front passenger seat of this vehicle if the passenger airbag is not deactivated. If you do so, the child could be severely injured when the airbag is triggered.

Your vehicle is equipped with an airbag supplemental restraint system for the front passenger. Because the backrest on any rearward-facing child-restraint system, of the kind designed for infants under 1 year and 20 lbs./9 kg, would be within the airbag's deployment range, you should never mount such a system in the front passenger seat, since the impact of the airbag against the child restraint's backrest could lead to serious or fatal injuries. ◀

More information on Automatic deactivation of the front passenger airbags, refer to page 98.

Installing child-restraint systems

Before installing any child-restraint system or child seat, read the following:

 Observe the child-restraint system manufacturer's instructions for installation and use. Otherwise the degree of protection can be reduced.

Following an accident, have all parts of the

child restraint system and the affected vehicle safety-belt system checked and, if necessary, replaced. Only have corresponding work carried out by a BMW center or a workshop that uses personnel trained in accordance with BMW requirements. ◀

Commercially-available child-restraint systems are designed to be secured with a lap belt or with the lap belt portion of a combination lap/shoulder belt. Improperly or inadequately installed restraint systems can increase the risk of injury to children. Always read and follow the instructions that come with the system.

Child seat security



All of the rear belt retractors and the front passenger's safety belt can be locked for mounting and securing child-restraint systems.

Information regarding this is located near the buckle latch of each safety belt.

To lock safety belt

Pull the entire length of the belt from the belt retractor. Allow the reel to retract the belt somewhat and engage the buckle, then tighten the belt against the child-restraint system. The retraction mechanism is now locked.

To unlock safety belt

Release the buckle, remove the child-restraint system and allow the belt retractor to reel the belt completely in.

Child-restraint system with tether strap

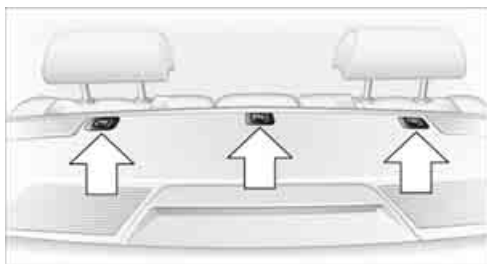

If you use a child-restraint system with a tether strap, three additional tether anchor points have been provided, refer to the arrows in the illustration. Depending on the location selected for seating in the rear passenger area, attach the tether strap to the corresponding anchorage point to secure the child-restraint system, as shown in the illustration below.

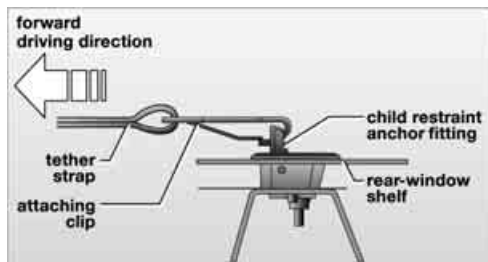

Each sitting position is fitted with a head restraint.

Outer sitting positions:

Lift the head restraint and pass the tether strap between the head restraint and the seat back. It is recommended to readjust the head restraint into the lowest possible position.

Center sitting position:

The head restraint must be adjusted into the lowest possible position. Pass the tether strap over the head restraint.

▶ Adjust the tether strap according to the child-restraint manufacturer's instructions. ◀

LATCH child-restraint fixing*

LATCH: Lower Anchor and Tethers for Children.

The rear outer sitting positions are provided with anchors for a LATCH child-restraint fixing.

 To fit the LATCH child-restraint fixing, follow the operating and safety instructions of the manufacturer. ◀

If the vehicle is equipped with power seats in the rear, return these to their standard adjustment setting before using a LATCH child-restraint fixing, refer to page 49.

Access to anchorage points

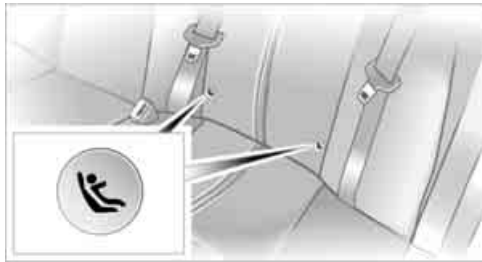

The illustration shows the left rear seat as an example.

The anchorage points for the LATCH child-restraint fixing are located underneath the identifying symbols.

Installation guide

The installation guide makes it easier to fit the LATCH child-restraint fixing and at the same time protects the surface of the seats.

 The installation guide is available at your BMW center. Always observe all instructions for operation and use provided by the manufacturer in the installation guide. ◀

1. Engage the center safety belt into the belt buckle
2. Pull the belt away from the area of the child-restraint fixing

3. Firmly press the installation guide into the gap between the upholstery on seat and backrest, continuing until the two funnel-shaped guides snap into place in the LATCH support braces in the seat.

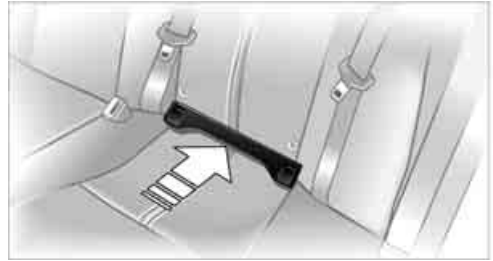

Pull the installation guides to remove.

On journeys

 Make sure that children do not lean out of the child's seat towards the door panels. Otherwise severe injuries can be caused if the side airbags are triggered. ◀

Child-safety locks for rear doors



Slide down the safety levers on the rear doors:

The door can now be opened from the outside only.

Safety switch for power windows and rear seats

If the vehicle is equipped with power seats in the rear, return these to their standard adjustment setting before using a child-restraint system, refer to page 49.

Always press the safety switch for the power windows, refer to page 44, when children are in the rear of the vehicle.

This switch also disables the power rear seat adjustment.



Incorrect or unsupervised adjustment of the power seats in the rear could lead to injuries or damage to the child-restraint system. ◀

Driving

Ignition lock



Insert the remote control all the way into the ignition lock. This also activates the radio mode.

▶ When the remote control is in the ignition lock you can start the engine without first switching on the ignition. ◀

Comfort Access*

Carry the remote control on your person if you want to use the Comfort Access.

With Comfort Access, you do not need to insert the remote control in the ignition lock. You can switch the ignition on and off, see below, or start the engine, page 63, when a remote control is detected in the vehicle interior.

▶ When you switch off the engine, the transmission moves automatically to position P: interlock. ◀

Switching ignition on and off

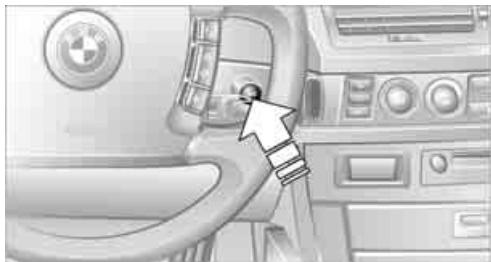

Continue to briefly press the start/stop button to switch the radio mode on and off or switch the ignition on and off.

▶ Do not press the brake pedal until you are ready to start the engine. If you briefly press the start/stop button while the brake pedal is pressed the engine will start immediately. ◀

Radio mode

Several systems, such as the Control Center, independent ventilation, etc., are available for use. The time and outside temperature appear in the Info Display.

▶ The radio mode is automatically deactivated:

- ▶ After approx. 16 minutes, when a door is closed and the system does not register the presence of any individuals in the vehicle
- ▶ Immediately if the remote control is removed from the ignition lock
- ▶ With Comfort Access, by pressing the door handle. ◀

Ignition switched on

All vehicle systems are ready for operation.

Ignition off

The indicator lamps in the Info Display go out. Only the automatic transmission's range display remains visible for a brief period.

Removing remote control from ignition lock

Press the remote control in briefly; it is ejected and now protrudes slightly from the lock. This procedure will also switch off the ignition if it is on.

▶ Switch off the engine before removing the remote control from the ignition lock.

The transmission automatically shifts to position P: interlock. ◀

If the remote control is still in the ignition lock when the driver's door is opened, a

gong will sound and a message will appear in the Info Display.

Starting engine

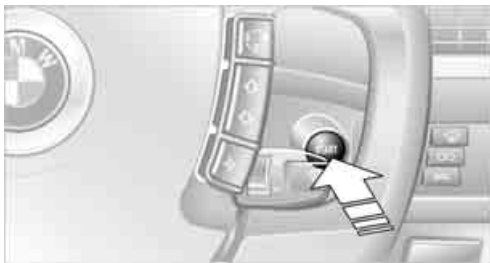

⚠ Do not run the engine in closed rooms, as otherwise the inhaling of toxic exhaust gases can cause unconsciousness and death. The exhaust gases contain carbon monoxide, an odorless and colorless, but highly toxic gas. Never leave an unattended vehicle with the engine running, as such a vehicle represents a potential safety hazard.

To prevent the vehicle from rolling, always select position P on the selector lever and engage the parking brake before leaving the vehicle with the engine running. ◀

When starting the engine, do not press the accelerator pedal.

Do not allow the engine to warm up by leaving it running while the vehicle remains stationary. Instead, begin to drive immediately at a moderate engine speed.

Your BMW is equipped with the convenience starting feature. After pressing the brake pedal, all you need to do is briefly press the start/stop button. The system responds by automatically engaging the starter and allowing it to run until the engine starts, after which it then disengages automatically.

If the engine fails to start on the first attempt, for instance, if it is very hot or cold: Press the accelerator pedal halfway down while engaging the starter.

During a cold start at very low temperatures, below +5 °F/-15 °C, at high altitudes over 3,281 ft/1,000 m:

- ▷ Engage the starter for approx. 10 seconds the first time
- ▷ Press the accelerator pedal halfway down while engaging the starter.

⚠ Refrain from starting the vehicle repeatedly at brief intervals, and avoid an excessive number of starting attempts if the vehicle fails to start; repeated activation of the starter over an extended period would allow unburned or only partially combusted fuel to enter the catalytic converter, where it can cause overheating and damage to the unit. ◀

▷ If you have accidentally switched off the engine while driving, it can be restarted from a speed of approx. 3 mph/5 km/h by pressing the button. It is not necessary to press the brake pedal. ◀

Switching off engine

With the vehicle stationary, briefly press the start/stop button. This also activates the radio mode.

The transmission automatically shifts to position P: interlock.

▷ Transmission position N remains engaged if you keep to the following order:

1. With Comfort Access: insert the remote control into the ignition lock
2. With the engine running, engage transmission position N
3. Switch off the engine
4. Leave the remote control in the ignition lock.

This function is useful in automatic car washes, etc.

Position P is engaged automatically after approx. 30 minutes or when you remove the remote control from the ignition lock. Remember to observe the Check Control for status messages. ◀

 Should exceptional circumstances render it necessary for you to switch off the engine while the vehicle is moving, press the start/stop button for approximately 1 second.

If you maintain pressure on the start/stop button for longer than two seconds while switching off the ignition, the remote control will be ejected. ◀

 Before leaving the vehicle, remove the remote control from the ignition lock; with Comfort Access, always take the remote control with you. ◀

Parking brake

The concept

Your BMW is equipped with an electromechanical parking brake.

The parking brake is primarily intended to prevent the vehicle from rolling while parked.

You can operate or use the parking brake in two different ways:

- ▷ Manually, by briefly pressing the button
- ▷ Automatically, through activation of the Automatic Hold mode, refer to page 65.

An electrohydraulic mechanism then engages the parking brake to prevent the rear wheels from turning whenever you switch off the engine.



When the engine is running, parking brake engagement is controlled by the brake system's hydraulic circuits, which act on the disc brakes at the front and rear wheels.



Brake pedal feel

Because this function is activated using the brake system's hydraulic circuits, the response of the brake pedal may change slightly. Engagement may also be accompanied by activation noise – this is normal.

Manual engagement





 Briefly press the button, the word PARK appears briefly in the Info Display. With the parking brake engaged, the indicator lamp  lights up red in the Info Display, refer to page 12.

 With the ignition off, the indicator lamp  goes out after a brief period. ◀

Manual release

 With the ignition on, briefly press the button: the indicator lamp in the Info Display goes out.

 Provided that the remote control is inserted in the ignition lock, you can also release the parking brake after the engine has been switched off. This function is intended for use in automatic car washes, etc. ◀

 When leaving the vehicle, always release the remote control from the detent in the ignition lock; this precaution prevents children from disengaging the parking brake, etc.



The parking brake can still be engaged at any time when the remote control is released from the detent. It is only possible to disengage the parking brake with the ignition on. ◀

 If exceptional circumstances should make it necessary to engage the parking brake while the vehicle is in motion, maintain pressure on the button. The indicator lamp appears in red in the Info Display. A gong sounds at the same

time.

The brake lamps come on.

The vehicle continues to brake automatically for as long as you maintain pressure on the button. ◀

 When you brake the vehicle to a virtual stop, i.e., down to a speed of approximately 2 mph/3 km/h or below, the parking brake remains engaged. The indicator lamp  in the Info Display lights up red. Briefly press the button to disengage the parking brake manually. ◀

Automatic Hold

You can activate this feature after starting the engine; it then remains operational until the next time the engine is switched off.

This feature provides supplementary support during vehicle operation by automatically engaging and releasing the parking brake during stops at traffic lights, in stop-and-go traffic, etc. As the vehicle then no longer tends to creep when the transmission is engaged, it is no longer necessary to hold the vehicle by pressing the brake pedal.

It prevents the vehicle from rolling backward during uphill starts.

The parking brake engages automatically when you stop the vehicle and switch off the engine.

You can activate or cancel the Automatic Hold feature by selecting the "Settings" menu in the Control Center. A description of the Control Center is provided on page 17.

Automatic Hold activation/deactivation

1. Select "Settings"
 2. Select  and confirm
 3. Select "AUTO P". Press the controller to activate/deactivate the desired function
- ▶ Automatic Hold is activated. The green AUTO P status message in the Info Display shows you that the system is ready for operation

- ▶ Automatic Hold is deactivated. The green AUTO P status message disappears from the Info Display.

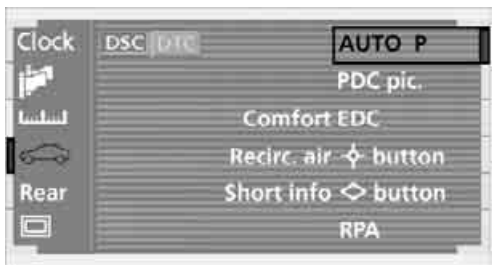



 You can assign the Automatic Hold function to the programmable button on the steering wheel, refer to page 54. This feature then provides you with quick access to the Automatic Hold function, allowing you to control it without undue distraction from road and traffic conditions. ◀

 You can also deactivate Automatic Hold by pressing the button while the vehicle is stationary. The vehicle remains stationary, the indicator lamp changes from green to red. Press the button again to release the parking brake.

Driving with Automatic Hold

The parking brake engages automatically when the vehicle comes to a stop. The indicator lamp  in the Info Display lights up green.

To start off again, simply press the accelerator pedal. The parking brake is released automatically; the indicator lamp  goes out.

 Do not drive through an automatic car wash with the Automatic Hold on and the engine running. The system would engage the parking brake while the vehicle is stationary. ◀

Parking with Automatic Hold

The parking brake engages automatically when you stop the vehicle and switch off the engine. The indicator lamp  changes from green to red.

 Provided that the remote control is inserted in the ignition lock, you can also release the parking brake manually after the engine has been switched off, refer to page 64. This function is useful in automatic car washes, etc. Automatic Hold is deactivated. ◀

 When leaving the vehicle, always release the remote control from the detent in the ignition lock; this precaution prevents children from disengaging the parking brake, etc. ◀

For your safety

Automatic Hold is automatically deactivated when

- ▷ the engine is switched off
- ▷ the system detects that the driver's seat is not occupied while the engine is running
- ▷ the hood is opened while the engine is running
- ▷ the luggage compartment is opened with the transmission in position R while the engine is running, and
- ▷ when the parking brake is used to bring the vehicle to a stop.

The indicator lamp  changes from green to red, and the AUTO P letters in the Info Display disappear.

Before starting off again, briefly press the button to disengage the parking brake manually, refer to page 64, or reactivate Automatic Hold, refer to page 65.

 Before leaving the vehicle with the engine running, always move the automatic transmission's selector lever to position P and ensure that the parking brake is engaged. The vehicle could start to roll if you fail to observe these precautions. Never leave an unattended vehicle with the engine running, as such a vehicle represents a potential safety hazard. ◀

 Automatic Hold is automatically deactivated whenever the system detects any tendency for the wheels to spin in response to slippery road surfaces. Note

the status reports in the Check Control. You can find additional information on the Check Control on page 83. ◀

Malfunction

If a malfunction occurs, the indicator lamp  lights up yellow in the Info Display and a status report will appear in the Check Control. Please note any supplementary information that appears on the Control Display.

Releasing parking brake manually

You can respond to any interruptions in the supply of electrical power, for instance, if the battery is discharged or disconnected, by releasing the parking brake manually.

 Before proceeding to release the parking brake manually, and each time you park the vehicle without engaging the parking brake, always ensure that the automatic transmission's selector lever is in position P, refer to page 68. Note the range indicated in the Info Display.

If the wheel must be changed on a surface with a more severe slope, take additional precautions to secure the vehicle from rolling e.g. with a chock, refer to page 204. Otherwise there is a danger that the vehicle could start to roll if parked on a steep slope. ◀

Should it also be necessary to release the automatic transmission's lockout manually, for instance, if the battery is discharged, always adhere to the following sequence:

1. If necessary, start by manually releasing the parking brake
2. Then release the automatic transmission's lockout manually, refer to page 70.

Jump-starting and towing, refer to pages 209 and 210.

What you will need

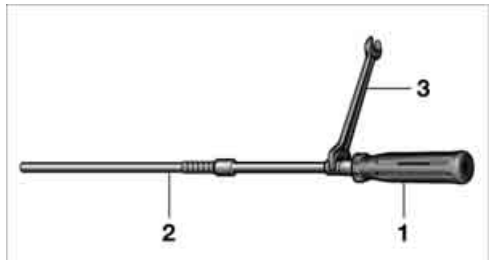

- 1 Screwdriver handle
- 2 Emergency-release tool
- 3 10 mm open-end wrench

You will find the required tools in the onboard tool kit mounted on the inside of the luggage compartment lid, refer to page 201.

Insert the emergency-release tool in the screwdriver handle as shown in the illustration.

Releasing

1. Remove the floor mat and the cover on the spare tire
2. Guide the emergency-release tool with the screwdriver handle into the opening, arrow 1
3. Apply the open-end wrench to the hexagon on the emergency-release tool.

Press against the resistance from the spring to guide the emergency-release tool all the way in, then hold it in place. Turn the emergency-release tool in the direction indicated by arrow 2, continuing until you hear the mechanism snap into place and feel resistance; maintain pressure on the tool after the mechanism engages

4. Use the open-end wrench to turn the emergency-release tool against the drive unit's mechanical resistance, continuing to rotate it in arrow direction 2 until you feel a substantial increase in turning effort



 To prevent possible damage to the rear brakes, always make sure that the parking brake is completely released before driving the vehicle. ◀

5. Return the tools to their places
6. Return the spare tire cover and the floor mat to their original locations.

 Have any defects repaired at the nearest BMW center. The technicians can also return the parking brake to normal operational status after it has been released manually in response to malfunction. ◀

 Following manual release, the actual status of the parking brake may vary from that displayed by the indicator lamp. ◀

Operation after interruptions in power supply

 The parking brake may only be used again, if it was released manually after an interruption in power supply, i.e. as a result of a discharged or disconnected battery. If this is not done, the parking brake may fail to operate correctly. Even with the parking brake engaged, there would be a danger of the vehicle rolling on steep hills. ◀

Once the electrical power supply has been restored you can again use the parking brake:



With the ignition on and the vehicle stationary, briefly press the button three times at intervals of approx. 5 seconds. This initializes the system as follows:

- ▷ Initializing the disengaged setting

- ▷ Engaging: the system registers the new status and the brake setting is initialized. The indicator lamp (P) in the Info Display lights up red.
- ▷ Releasing: the parking brake is ready for operation. The indicator lamp (P) in the Info Display goes out.

Automatic transmission with Steptronic

In addition to fully automatic operation, you can also manually shift with the button on the steering wheel, refer to page 70.

Transmission range selection



P R N D

The selector lever position is indicated, and in the manual mode the gear currently engaged.

Program display

S or M1 – M6

Buttons on steering wheel



Press briefly to proceed through a selection sequence consisting of the automatic program, the Sport program, and the manual mode.



Steptronic:

Upshifting and downshifting, refer to Sport program and manual operation.

Selecting transmission range

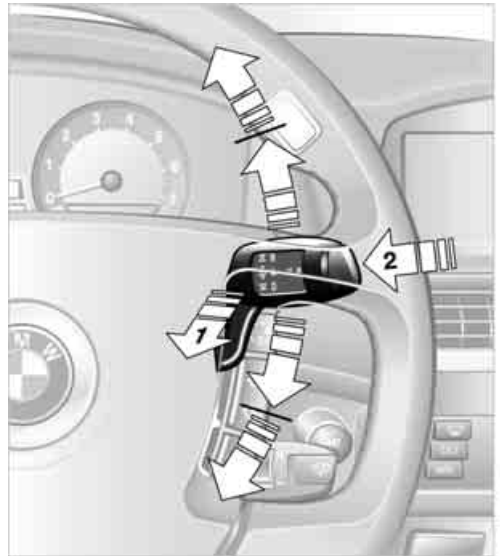

▷ The selector lever is at the center position. To select transmission ranges D, R or N, always start by pulling toward the steering wheel, arrow 1, then press up or down. Note the range indicated in the Info Display. ◀

- ▷ Range D or R: Press the selector lever up or down, continuing to apply pressure to move it beyond the resistance point
- ▷ Neutral N: Press the selector lever up to the resistance point

- ▷ Park P:
Press button P, arrow 2.

The selector lever immediately returns to the center position when released.

 With the vehicle stationary, press the brake pedal before shifting out of P or N; the shift command will not be executed unless the brake is applied: shiftlock. To prevent the vehicle from creeping after you select a range, maintain pressure on the brake pedal until you are ready to start. You can activate the Automatic Hold feature to suppress the vehicle's tendency to creep, refer to page 65. ◀

Shift commands are transmitted electronically. To help avoid malfunctions, each command undergoes a plausibility check prior to execution.

Remember to observe the Check Control for status messages.

You can find additional information on the Check Control on page 83.

 To prevent the vehicle from rolling, always select position P and engage the parking brake before leaving the vehicle with the engine running. Note the information provided in the Info Display. Never leave an unattended vehicle with the engine running, as such a vehicle represents a potential safety hazard. ◀

P Park

Select only when the vehicle is stationary. The transmission lockout prevents the rear wheels from turning. The lockout disengages when you press the selector lever toward D, N or R while the engine is running.

 P is engaged automatically as soon as you switch off the engine unless N is engaged and the remote control is inserted in the ignition lock, refer to page 63. ◀

R Reverse

Select only when the vehicle is stationary.

N Neutral

Select only if your journey is interrupted for a long period.

- ▷ From D press the selector lever up
- ▷ From R press the selector lever down.

Note the arrows indicating direction in the range display.

 N remains engaged whenever the remote control remains in the ignition lock after the ignition is switched off. This function is useful in automatic car washes, etc.

After approx. 30 minutes the system automatically engages P. Remember to observe the Check Control for status messages. Switching off engine refer to page 63. ◀

D Drive, automatic driving position

This is the range recommended for normal vehicle operation. All forward gears are available.

Under normal operating conditions, fuel consumption is lowest when driving in position D.

Kick-down

The kick-down mode provides maximum acceleration.

Press the accelerator pedal beyond the full-throttle resistance point.

Sport program and manual operation



Press the S/M/D button on the steering wheel:

The sport program is activated, and S appears in the program indicator of the Info Display. This program is recommended for a performance-oriented driving style.

Pressing the S/M/D button again switches into the manual mode.

When the buttons on the back of the steering wheel are touched, the transmission upshifts. When the buttons on the front of the steering wheel are touched, the transmission downshifts. The Info Display shows the manual ranges M1 through M6.

Upshifts and downshifts are executed only when they will result in a plausible combination of engine and vehicle speed; thus, for example, a downshift that would cause the engine to overrev will not be executed by the system. The selected gear appears briefly in the Info Display, followed by the current gear.

Pressing the S/M/D button again switches into the Automatic program again, and D appears in the program indicator of the Info Display.

Malfunction

A message appears in the Check Control and in the Control Display. The directional arrows also start to flash in the Info Display. A malfunction has occurred in the transmission system. Avoid heavy loads.

While it will remain still possible to move the selector lever to any desired position, the transmission will revert to operation in its default mode with only a limited number of forward gears.

Have the system checked as soon as possible.

Jump-starting and towing, refer to pages 209 and 210.

Manual release of transmission lockout

You can respond to any interruptions in the supply of electrical power, for instance, if the battery is discharged or disconnected, by releasing the transmission lockout manually.

 To prevent the drive wheels from locking up and sliding, the transmission lockout must always be released manually before the vehicle is towed. ◀

 Press the brake pedal before releasing the transmission lockout manually. If the brakes are not applied, the vehicle could start to roll if parked on a steep slope.

The transmission lockout should only be released for towing. Remember to engage the transmission lockout when you repark the vehicle after moving it.

Should it also be necessary to release the parking brake manually, owing to a discharged battery, etc., always adhere to the following sequence:

1. Start by manually releasing the parking brake, refer to page 66
2. Then proceed to manually release the transmission lockout. ◀

Jump-starting and towing, refer to pages 209 and 210.

Releasing

1. Use the vehicle key to release the cover panel beneath the instrument panel by turning the lock counterclockwise, then fold down the cover



2. Pull out the release lever with the loop **1** until it locks into place: the transmission lockout is unlocked.



⚠ Re-engage the transmission lockout after parking the vehicle at its destination. Otherwise there is a danger that the vehicle could start to roll if parked on a steep slope. ◀

Locking again

1. Disengage the release lever by pressing it together with the red detent lever, arrow



2. Guide the release lever all the way back into its original position – the transmission lockout is again engaged
3. Fold up and lock the cover panel again. Now – and not before – the key may be removed.

⚠ Once the transmission lockout has been re-engaged, the warning in the Check Control should disappear, and the symbol in the Info Display should change from N to P. Should this fail to happen, there is a danger that the vehicle could start to roll. ◀

Information on jump-starting and towing begins on page 209.

Turn signals/ headlamp flasher

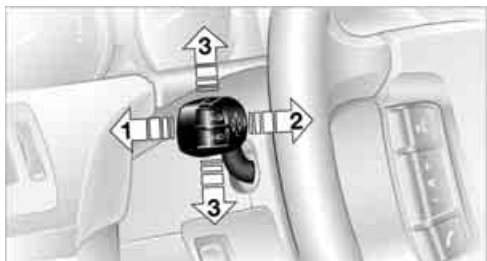

- 1 High beams
- 2 Headlamp flasher
- 3 Turn signals

Using turn signals

Move the lever beyond the resistance point. It then returns to the center position when released. Press the lever up to the resistance point to switch off the turn signals.

Signaling briefly

Press the lever up to but not beyond the resistance point. It then returns to the center position when released.

If the flashing of the indicator lamp and the ticking from the relay are both faster than usual, this indicates that one of the bulbs is

defective; if a trailer is attached, this could also indicate that one of its turn signal bulbs is defective.

Wiper system

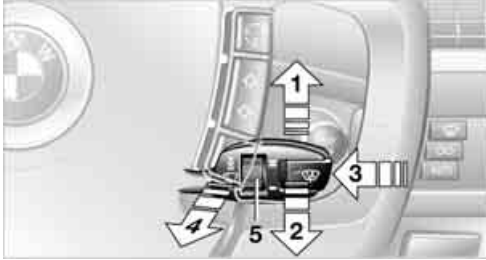

- 1 Standard wiper speed: briefly press once.
Fast wipe: briefly press twice
 - 2 To switch off wipers or for brief wipe
 - 3 To activate/deactivate rain sensor
 - 4 To clean windshield and headlamps
 - 5 To adjust rain sensor sensitivity level
-  The lever automatically returns to its initial position when released. ◀

1 Standard wiper speed

The system automatically reverts to operation in the intermittent mode whenever the vehicle is stationary.

Fast wiper speed

You can also select this position by pressing the lever upward beyond the resistance point.

The system automatically reverts to operation in the standard wipe mode whenever the vehicle is stationary.

4 Cleaning windshield

The system sprays washer fluid against the windshield and activates the wipers for a brief period.

Headlamp washers

Each fifth time you press into position 4 to clean the windshield while the headlamps are on.

 Do not use the washers if there is any danger that the fluid will freeze on the windshield. If you do so, your vision could be obscured. To avoid freezing, use a washer fluid antifreeze, refer to page 73. Avoid activating the washer when the reservoir is empty, as damage to the pump could result. ◀

Windshield washer nozzles

The windshield washer nozzles and the windshield itself in the area around the wipers are heated automatically when the ignition is switched on.

Rain sensor

The rain sensor is located on the windshield, directly in front of the interior rear-view mirror.

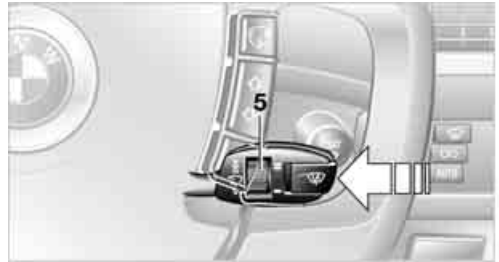

Activating rain sensor

Briefly press the button as of ignition in radio mode. The indicator lamp comes on. The wipers will always respond by completing at least one sweep of the windshield.

Adjusting rain sensor sensitivity level

Turn the serrated dial 5.

Deactivating rain sensor

Briefly press the button again. The indicator lamp goes out.

 The rain sensor is automatically deactivated when you switch off the ignition. ◀

 Deactivate the rain sensor when passing through an automatic car wash. Failure to do so could result in damage caused by undesired wiper activation. ◀

Selecting wiper fold-out position

Important for changing wiper blades, when folding away from windshield to prevent blades from sticking when ice forms, etc.

1. Switch off the engine and remove the remote control from the ignition lock
2. Press the wiper lever up and maintain pressure for about 3 seconds until the wipers are roughly vertical: this is the fold-out position.

After folding the wipers back against the windshield you will need to reactivate the wiper system:

1. Insert the remote control to activate the radio mode in the ignition lock
2. Apply brief upward pressure to the wiper lever. The wipers return to their retracted position and are ready for normal operation.

 To prevent damage to the wipers, always fold them back against the windshield before switching on either the radio mode or the ignition. ◀

Washer fluid

 Washer fluid antifreeze is flammable. Always keep it well away from sparks and open flames, and store it in tightly closed containers well out of the reach of children. Always observe the instructions for use provided on the containers. ◀

 We recommend that you mix the washer fluid before adding it to the reservoir. ◀

Windshield and headlamp washer system

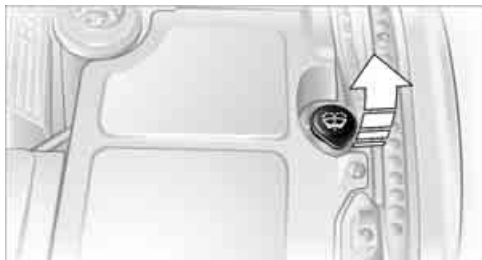

Capacity: 6.3 US quarts/6 liters.

Fill with water and – if required – with a washer antifreeze, according to manufacturer's recommendations.

Programmable cruise control

The concept

The programmable cruise control is available for use at speeds of approx. 20 mph/30 km/h and higher. The vehicle maintains and stores the speed that you set using the lever mounted on the steering column.

You can also use the multilevel preset mode to store 6 desired speeds for later selection with the same lever, refer to page 74.

This feature assists you in quickly adapting the vehicle speed to specific road conditions, e.g. changes in speeds limits.

 Do not use the programmable cruise control when driving on winding roads, in heavy traffic or in poor road conditions, e.g. snow, rain, ice, loose road surface, that do not permit a constant speed. ◀

One lever for all functions

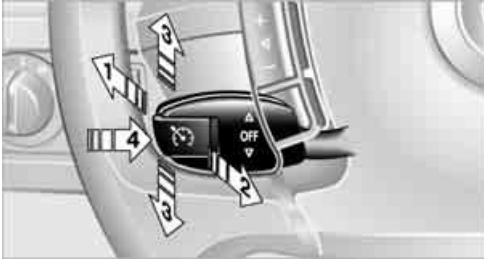

1 Maintaining and storing speed, accelerating

Press the lever up to the resistance point: The system maintains and stores the current vehicle speed. Every time you briefly press the lever, the vehicle's speed increases by roughly 1 mph/1 km/h.

Press the lever longer: The vehicle accelerates without pressure on the accelerator pedal. The system maintains and stores your current speed as soon as you release the lever.

 The vehicle may accelerate beyond the preset speed on steep downhill stretches where the engine's braking effect alone may not be sufficient to slow the vehicle. Speed can drop on uphill grades if the engine output is insufficient. ◀

2 Maintaining and storing speed, decelerating

Pull lever:
Functions similar to **1**, only the vehicle speed is decreased.

3 Interrupting cruise control

With the cruise control active, briefly press the lever up or down.

In addition, cruise control is interrupted automatically

- ▷ when you apply pressure to the brake pedal
- ▷ when you select neutral position of the automatic transmission
- ▷ when the DSC control is operative.

4 Recalling stored speed

Briefly press button **4**:
The vehicle accelerates to and maintains the last speed stored.



Deactivating system

When the ignition is switched off, the system is deactivated and the stored speed is deleted.

Displays in Info Display



5 Display of speed ready for recall.

- ▷  cruise control activated
- ▷  cruise control deactivated

6 Display of stored desired speed in the multilevel function

 **5** and **6** are displayed when the system is activated. ◀

Storing desired speeds

With vehicle stationary

Switch on the ignition.

Press **1** or pull **2** the lever beyond the resistance point: the selectable speed level is displayed with **5**.

- ▷ To increase desired speed:
Press the lever forward
- ▷ To decrease desired speed:
Pull back the lever
- ▷ To store desired speed:
Press button **4** for approx. 3 seconds.
The stored desired speed appears in **6**.

 If **6** speeds have already been stored, it will be necessary to delete one before entering a new preset speed. ◀

While driving

Press **1** or pull **2** the lever beyond the resistance point:

Press button **4** for approx. 3 seconds. The respective driven speed is applied as the desired speed and displayed with **6**.

 If all of the graduations flash twice, this indicates that 6 desired speeds have already been stored. You must then delete at least one. ◀

Deleting desired speeds

Select the desired speed **5**.

Press button **4** for approx. 3 seconds.

Activating multilevel preset mode

Press **1** or pull **2** the lever beyond the resistance point.

The current driving speed is maintained, stored and displayed as the available speed **5**.

 If no desired speeds are stored, you can increase or reduce the speed by 5 mph/10 km/h with the multilevel preset mode activated each time you press or pull the lever beyond the resistance point. ◀

Selecting desired speed

Press **1** or pull **2** the lever beyond the resistance point.

The next desired speed is selected.

 The available speed changes to the minimum speed of approx. 20 mph/30 km/h when you pull the lever beyond the resistance point **2** at the lowest desired speed. ◀

Interrupting the cruise control

With the cruise control active, briefly press the lever up or down **3**.

Hiding display for multilevel preset function

When activated, press the lever up or down **3** for approx. 3 seconds.

Showing display for multilevel preset function again

Press **1** or pull **2** the lever beyond the resistance point.

Deactivating multilevel preset mode

The multilevel preset function is also deactivated when you switch off the ignition.

Active cruise control*

The concept

With active cruise control you can select a desired speed which is not only automatically maintained when driving on open roadways, but also varied to maintain a selected distance setting as slower traffic is encountered.

Active cruise control is a technological advance over the familiar cruise control and is a welcome relief from the constant adjustment of speed that can accompany driving in traffic on freeways or other high-speed thoroughfares. Especially on longer trips, the system can reduce fatigue and tension, while increasing your enjoyment of driving. Please use it safely and responsibly.

In addition to holding a steady cruising speed, if you do encounter slower vehicles ahead, active cruise control will, within the scope of given possibilities, adjust your vehicle's speed automatically so that you can flow with the traffic without frequent intervention by the driver. If, for example, while cruising at the selected speed, you begin to approach a slower vehicle ahead of you in the same lane, the system will reduce your vehicle's speed to the same as that of the vehicle ahead to maintain your selected distance setting between your vehicle and the vehicle ahead. There are four settings for distance, which is additionally speed-dependent. Based on your selected distance setting, the system automatically decreases the throttle setting and lightly applies the brakes if necessary.

The vehicle brake lamps will automatically illuminate to signal a following driver to take action. In addition, it may be necessary for the vehicle to downshift to maintain the distance setting selected. If the vehicle ahead speeds up or when the lane ahead becomes clear, your vehicle will accelerate to the speed you have selected by increasing the throttle setting and shifting gears as needed.

 Active cruise control is not and must not be used as a collision avoidance/warning system. ◀

 Since this active cruise control system is a new technology and operates differently from conventional cruise control systems which you may be accustomed, you are strongly urged to read all of the pages relating to this system before use. Pay special attention to the information contained in the Things to know about active cruise control section in this manual beginning on page 78. ◀

Info Display screen contents



- 1 Stored desired speed display
- 2 Detected vehicle display. Lights up when vehicle driving ahead is detected
- 3 Selected distance to vehicle driving ahead
- 4 Digital speed display. Appears briefly when you select your desired speed, refer to page 77

 The system is activated. The display appears as soon as you activate the system and no vehicle is detected driving ahead.



Vehicle detected. The display lights up when a vehicle is detected driving ahead.

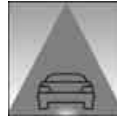

The system requests you to intervene by braking or with an evasive maneuver. The display flashes and a chime sounds.

The active cruise control cannot automatically restore the distance to the vehicle driving ahead. You will find more detailed information on page 80.



Automatic intervention by ABS or DSC, or you actuate the parking brake while driving. The active cruise control now only intervenes by braking.

Operating active cruise control

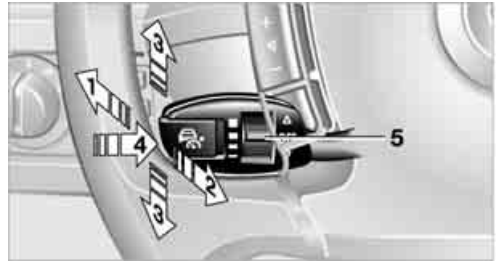

- 1 Activate system, store and increase desired speed
- 2 Activate system, store and decrease desired speed
- 3 Deactivate system
- 4 With system deactivated: Briefly press the button to recall the stored speed and distance
- 4 With system activated: Increase desired speed by 1 mph/ 1 km/h with each press of the button
- 5 Select distance to vehicle driving ahead. You can choose from four available distance settings. You will find more detailed information on page 78

! Adjust your desired speed to the traffic conditions and remain ready to brake at all times. Great differences in speed to the vehicles driving ahead, e.g. when quickly approaching a truck or when another vehicle swerves into your lane, cannot be compensated for by the system. ◀

Activate system



From approx. 20 mph/30 km/h you can activate the system by pressing the lever forward or pulling it back: The current driving speed is stored as a desired speed and briefly displayed in the speedometer, refer to arrow.

▷ If the display ACC --- mph/km/h appears briefly in the speedometer, it might be that conditions necessary for operation are not currently being met. To call up Check Control messages, refer to page 84. ◀

1 Desired speed store and increase

Press the lever forward:
The system applies and stores your current speed as a desired speed. The speedometer indicates this speed.
Subsequently pressing forward increases the desired speed to the next 5-mile place/ 10 km/h.
Each time the lever is pressed forward again, the desired speed is increased by another 5 mph/10 km/h until a maximum of 110 mph/180 km/h is reached. The speed then displayed is stored and reached on a clear road.

2 Desired speed store and decrease

Pull back the lever:
The current driving speed is rounded off to the next 5-mile place/10 km/h, displayed and stored.
Each time the lever is pulled back again, the desired speed is decreased by another 5 mph/10 km/h until the minimum speed of 20 mph/30 km/h is reached. The speed then displayed is stored and reached on a clear road.

3 Deactivate system

Press the lever up or down while the system is active. The displays in the speedometer disappear. You can use the system again as required.

In addition, the system is deactivated automatically:

- ▷ When you apply pressure to the brake pedal
- ▷ When you select the automatic transmission's neutral range N
- ▷ When you deactivate the DSC Dynamic Stability Control
- ▷ When you actuate the parking brake during driving
- ▷ When the system reduces the speed to below 20 mph/30 km/h due to a traffic situation.

! The system deactivates automatically when the speed is set to below 20 mph/30 km/h. A gong sounds and a message appears in the Check Control. The active intervention of the driver is required, otherwise there is an accident danger. ◀

Background lighting

You can switch off the background lighting of the speedometer and tachometer

- ▷ when you have deactivated the system
- ▷ when the prewarning field in the tachometer has gone out, refer to page 81
- ▷ when the destination guidance system of the navigation system is deactivated.

Press the lever up or down for approx. 1 second.

4 Resume to stored desired speed and distance setting

Press button 4:
The displays appear in the speedometer. The system is reactivated and uses the last stored desired speed and distance setting.

4 Fine adjustment of desired speed

In the activated state, the desired speed increases by 1 mph/1 km/h each time button 4 is pressed briefly.

5 Select distance

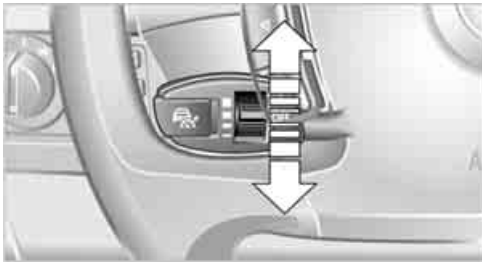

You can choose from four distance steps.

- ▶ Rotary switch upward: Increase distance
- ▶ Rotary switch downward: Decrease distance.

The selected distance is displayed in the speedometer.



Distance 1



Distance 2



Distance 3



Distance 4

This distance is always set when the system is used for the first time after starting the engine.



Use good judgment to select the appropriate following distance given road conditions, traffic, applicable laws and driving recommendations for safe following distance. ◀

Things to know about active cruise control

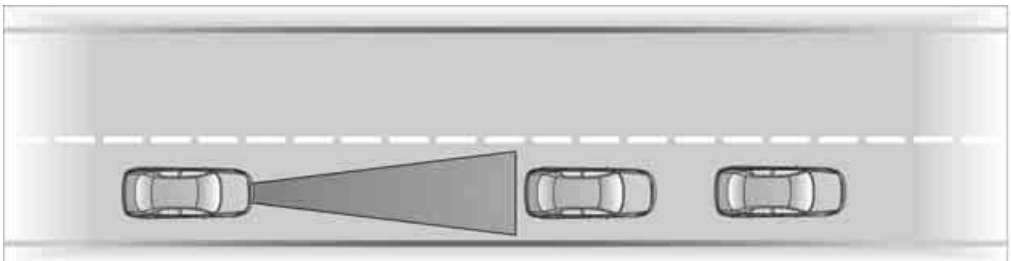

! As with conventional cruise control systems, active cruise control in no way diminishes or substitutes for the driver's own personal responsibility, alertness and awareness in adjusting speed, braking or otherwise controlling the vehi-

cle. The driver should decide when to use the system on the basis of road, traffic, visibility, and weather conditions. Active cruise control is intended for use on highway-type roadways where traffic is moving relatively smoothly. Do not use this system

in city driving; heavy traffic such as during rush hour; on curvy, winding roads, slippery roads or roads with sharp curves such as highway off-ramps; during inclement weather such as snow, strong rain or fog; or when entering interchanges, service/parking areas or toll booths. It is also important to regulate your vehicle's speed and distance setting within applicable legal limits. Always be ready to take action or apply the brakes if necessary, especially when the system is actively following a vehicle in front of you. ◀

! Always remember that the range and ability of the system does have physical limitations. It will not apply the brakes or decelerate your vehicle when there is a slow-moving vehicle, stopped vehicle or stationary object ahead of you, as for example, at a traffic light or a parked vehicle. Also, the system does not react to oncoming traffic, pedestrians or other type of potential traffic such as a rider on horseback. It is also possible that the system may not detect smaller moving objects such as motorcycles or bicycles. Be especially alert when encountering any of these situations as the system will neither automatically brake, nor provide a warning to you. Also, be aware that every decrease in the distance setting allows your vehicle to come closer to a vehicle in front of you and requires a heightened amount of alertness. ◀

If while your vehicle is actively following a vehicle in front of you and the vehicle ahead speeds up or the lane ahead becomes clear, then your vehicle will accelerate to the speed you have selected. Be aware that changing to a clear, unobstructed lane will also result in your vehicle accelerating.

! Be certain to deactivate the system when you pull into an exit lane for a highway off-ramp. ◀

Also, vehicles traveling in a staggered manner on a highway may cause a delay in the system's reaction to a vehicle in front of you or may cause the system to react to a vehicle actually in the lane next to you. Always

be ready to take action or apply the brakes if necessary.

Active cruise control can only decelerate the vehicle to approx. 20 mph/30 km/h. If the system reduces vehicle speed below 20 mph/30 km/h or if DSC/ABS is engaged while driving, the system will automatically deactivate.

! Remember, the system cannot stop your vehicle. In addition, the system is deactivated whenever the driver applies the vehicle brakes, shifts the transmission from drive/D to neutral/N, or deactivates DSC. After any deactivation, the system will no longer automatically activate the vehicle brakes, which means the driver must intervene and resume manual braking. You should then reactivate the system only when you are fully aware of the prior speed and distance settings. ◀

Active cruise control may brake when you reduce the stored desired speed; however, the driver must constantly monitor traffic and intervene if necessary.

When you switch off the engine or ignition, active cruise control is fully switched off, too, and any settings you have selected are canceled.

Behavior in curves



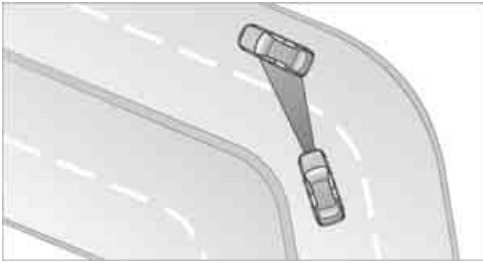

Because of the limited range of the system, it is possible that in curves or on the peaks and valleys of hilly roads, a vehicle ahead may be recognized late, or not at all. Therefore, it is up to the driver to select a speed that is prudent in view of the curves and terrain of the roadway.



In approaching a curve, it is possible that active cruise control would react briefly to a vehicle in the adjacent lane. In addition, the system can sense if your vehicle is in a curve and may not accelerate. If your vehicle decelerates in either case, you can choose to overcome the deceleration by briefly pressing the accelerator pedal.

Driver interventions

 Remember actions by the driver always supersede and take priority over the system's automatic actions. Anytime the driver presses down on the accelerator pedal, any automatic braking action by the system is interrupted until the pedal is fully released. After doing this, release the accelerator and the system again controls your cruising speed and distance setting. While driving with activated system, resting your foot on the accelerator pedal will cause the system not to brake even if necessary. Be certain that floor mats or other objects on the vehicle floor do not interfere with movement of the accelerator pedal. ◀

 While active cruise control is capable of braking your vehicle automatically when you approach a slower vehicle ahead, it is important to be aware that the ability of the system to apply the brakes is also limited, if you are driving down a steep grade or when you reduce your desired speed sharply. The system cannot stop your vehicle. It uses only a portion of braking system capacity and does not utilize the full capacity of the vehicle braking system. Therefore, the system cannot decrease your speed for large differences in speed between your vehicle and the vehicle

ahead. Examples: during emergency braking, when you approach a vehicle traveling at a much lower speed than your own speed such as approaching a toll booth or when a much slower vehicle cuts in front of you at close range. ◀



Whenever active cruise control recognizes a situation that requires driver braking because the system capacity has been reached or has been exceeded,

the system alerts the driver by flashing this symbol in the instrument cluster and sounding a chime.

Swerving vehicles

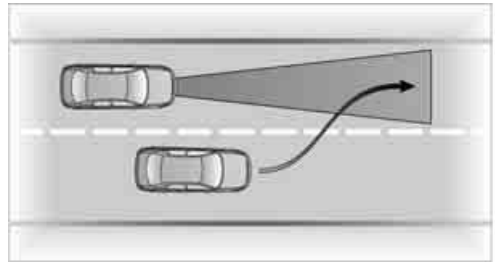

When a vehicle moves from an adjacent lane into your lane, active cruise control will not recognize this vehicle until it is fully in your lane ahead of your vehicle.

Malfunctions

The build-up of foreign material, e.g., snow, ice, dirt, road debris, etc., can lead to reduced detection performance of active cruise control. You should check the sensor under the front bumper and clean it as necessary prior to driving your vehicle. If the sensor becomes covered by foreign material or has a malfunction, it is possible that the sensor will no longer be able to detect vehicles in front of you. After the system recognizes that the sensor is no longer functional, a message is displayed in the Check Control and an acoustic signal is emitted, refer to page 83. Also observe the additional information provided in the Control Center.

Everything under control

Odometer, outside temperature display, clock



When the ignition is off you can briefly activate the time, outside temperature and odometer displays by pressing the knob at the upper left of the Info Display.

1 Outside temperature display, clock

The outside temperature and the time displays are active starting at the radio mode in the ignition lock.

You can change the units of measure, °F/°C, in the "Settings" menu, refer to page 89.

Setting the clock, refer to page 90.

Ice warning

A warning signal sounds when the outside temperature falls to roughly +37.5 °F/+3 °C, this is accompanied by a message in the Check Control.

 Please bear in mind that the ice warning does nothing to alter the fact that glare ice may be present on roads at temperatures higher than +37.5 °F/+3 °C, for instance, on bridges and shaded surfaces. ◀

2 Odometer

The odometer panel also provides displays for the computer and the Check Control.

Regardless of the current display mode, you can view the odometer reading for a short period by pressing the knob at the upper left of the Info Display.

Check Control, refer to page 83.
Computer, refer to page 85.

3 Trip odometer

The trip odometer must be present in the display before you can reset it to zero. Reset by pressing the knob at the upper left of the Info Display.

Tachometer



The orange warning sector gradually moves upward as the engine warms to its normal operating temperature. The segments disappear in sequence as the engine warms to its normal operating temperature.

Avoid allowing the engine speed to rise as far as the orange warning sector whenever possible.

Service requirement display

Info Display screen contents



The distance/period remaining until your next service briefly appears when you switch on the ignition.

 The Info Display immediately switches to its computer mode when you press one of the two buttons in the turn signal lever, refer to page 85. ◀

Control Display



You can view additional information on service and maintenance procedures by selecting the "Car data" menu.

1. Select  and confirm your selection
2. Select "Service" and confirm your selection



3. The display shows a list of selected service and maintenance procedures, as well as legally-mandated inspections.

Red sectors

The service deadline has already passed.

Yellow sectors

The deadline for service or a legally-mandated inspection is approaching. Please contact your BMW center for an appointment.

Green sectors

No service is currently required. If you desire, certain maintenance operations can be carried out at the next service at the customer's request.

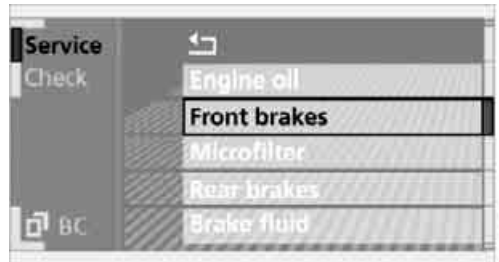



You can request more detailed information on every entry.

Turn the controller to scroll through the list, then confirm the selected entry.

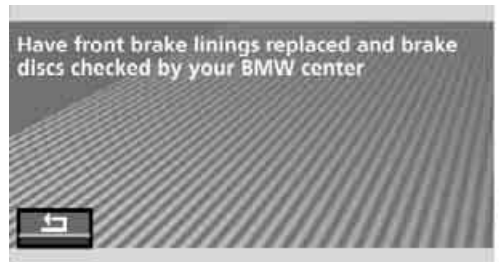
Select  and confirm your selection or turn the controller to exit the list.



Confirm  to hide the display.

 The service requirement display does not continue counting down to the next service during periods when the vehicle is stored with the battery disconnected

or the battery switch OFF.
Please remember that brake fluid should be changed every two years at the latest, even if the display does not yet indicate that service is required, refer to page 197.
This same precaution applies to all of the other service and maintenance operations scheduled according to periodic intervals. ◀

Displaying and entering dates for legally-mandated emission and vehicle inspections

1. Select "Emissions inspection" or "State inspection" and confirm your selection



2. Turn the controller to select date input
3. Confirm the inspection date. The first part of the date entry is activated – here month.
 - ▷ Turn to reset
 - ▷ Press to store and move to the next entry – here year.
The system applies the date the last time you store your entry



4. Press the controller to select "CONFIRM".
 - ▷ A requirement is that you have correctly set the date and time in the Control Center, refer to page 90. ◀

Info Display screen contents



If the deadline for your next emissions or state vehicle inspection is approaching, the remaining distance and time will appear briefly when you switch on the ignition.

- ▷ Your Service Advisor will determine your vehicle's current service requirements by reading out the data stored in the vehicle's key. ◀

Check Control

Messages and indicator lamps in Info Display



Messages and faults in systems appear in text form accompanied by an indicator lamp symbol. The alert is accompanied by a gong. Messages disappear again automatically if no faults are present.

Reports are assigned one of two priority ratings:

Priority 1:

These status messages and malfunction reports are signaled by a gong. Simultaneous defects will be displayed consecutively. These messages cannot be deleted, and they remain on the display until the

problem is corrected. Supplementary information is also shown on the Control Display, refer to Automatic display on Control Display.

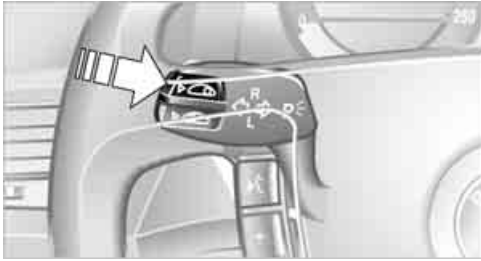

Priority 2:

These status messages and malfunction reports appear on the Info Display for approx. 20 seconds.

Briefly press the CHECK button on the turn signal lever to cancel the message in the display, if allowed by priority rating.

Requesting stored messages using Control Center see there.

Check Control symbol and messages on Control Display

 Depending on the status of the monitored systems, the Check Control symbol is displayed in different colors.

Yellow or red

Faults are present in the monitored systems. Depending upon how serious the problem is, a supplementary message may also appear on the Control Display.

Requesting stored messages using Control Center see there.

 The symbol in the status line also indicates the status of the service requirement display, refer to page 23. ◀

Automatic display on Control Display



These supplementary messages are intended to assist you in assessing the severity of malfunctions; they provide you with the information you need to decide on the best way to respond.

Select  and confirm your selection to switch off the display.

Requesting stored messages using Control Center

1. Select "Car data"
2. Select  and confirm your selection



3. Select "Check" and confirm your selection
4. The stored status reports appear on the display. Select the desired report and confirm your selection.

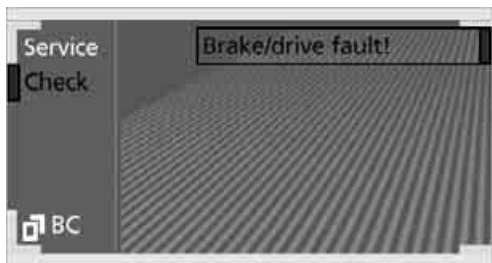

Confirm  to hide the display.

Displays after completion of trip

Selected fault reports generated during the trip are shown consecutively when you switch off the ignition.

If indicated, the following message may also appear:

"Parking lamps on!"

This message appears when you open the driver's door after parking. A supplementary gong is also heard.

Even with the ignition and Info Display off, you can reactivate the screen and display the messages.

Press the CHECK button for approx. 8 seconds, refer to page 84. The stored status reports appear again in the display. If several messages are present, you can continue to briefly press the CHECK button to view them in succession.

The Check Control function

- ▷ cancels itself automatically after a brief period
- ▷ can be canceled by again pressing the CHECK button for approximately 8 seconds.



You can select the language in which Check Control status reports and messages from the computer will appear, refer to page 89. ◀

Computer

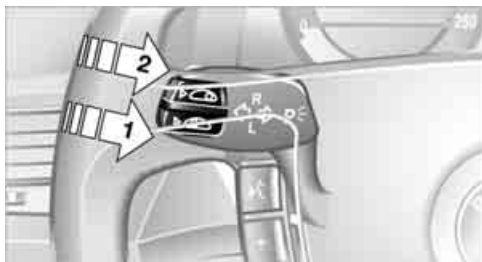

Requesting functions

You can use the buttons in the turn signal lever to request a display from the computer on the Info Display, starting at the radio mode in the ignition lock.

- 1 Info Display on left
- 2 Info Display on right

A new function appears each time you briefly press the button.

Displays on Info Display



The display sequence:

- ▷ Fuel gauge 86
- ▷ Range and remaining distance 86.



The display sequence:

- ▷ Odometer 81

- ▷ Energy Control/
current fuel consumption 86
- ▷ Average fuel consumption 86
- ▷ Average speed 86
- ▷ Time of arrival 87.

 Maintain pressure on button **1** to cancel the display from the computer. Briefly press the button again to return to the last display. It will not be possible to cancel the display if the fuel level has fallen into the reserve range or if a Check Control status report is currently on the screen. Briefly press the button again to view the last display. ◀

Fuel gauge

The fuel gauge mode appears automatically once the fuel level falls into the reserve range. At the same time, the words "Fuel reserve" appear. The tank still contains approx. 2.6 gallons/10 liters of fuel.

If the tilt of the vehicle varies, when you are driving in mountainous areas, for example, the indicator may fluctuate slightly.

 It will not be possible to cancel the computer display once the fuel level drops into the reserve range. However, you can still request a display of the travel range. Computer, refer to page 85. ◀

Fuel tank capacity: approx. 23.2 gallons/88 liters. You can find information on refueling on page 186.

 Refuel well before the tank is empty, as otherwise engine functions will not be ensured and damage can occur if you drive down to the last drop. ◀

Cruising range

Displays the estimated cruising range available with the remaining fuel. The fuel level is measured and the range is calculated taking the driving style over the last 20 miles/30 km into account.

 Always refuel as soon as possible once your range falls to below 30 miles/50 km, as otherwise engine func-

tions are not ensured and damage can occur. ◀

Refueling is only registered by the computer for fuel amounts above approx. 1.3 gallons/5 liters.

Remaining distance

When you enter a destination in the navigation system or manually enter a distance in the computer prior to departure, the system can also display the distance remaining to your destination, refer to page 132 or 87.

The system automatically applies the distance to your destination using the route recommended by the navigation system.

 When you enter a destination in the navigation system, any manual entries will be overwritten no later than once 1,640 ft/500 meters of the calculated distance have elapsed. ◀

Energy Control/ current fuel consumption

Shows the current fuel consumption. This allows you to see whether your current driving style is conducive to fuel economy with minimum exhaust emissions.

Average fuel consumption

The average fuel consumption is calculated for the time during which the engine is running.

You can use the Control Display to view your fuel consumption rate over two different distances, refer to Computer or Trip computer.

Average speed

Periods with the vehicle parked and the engine off are not included in the calculations of average speed.

Reset average speed: Press button **2** in the turn indicator lever for approx. 2 seconds.

Time of arrival

A display of your estimated time of arrival is available whenever you enter a destination in the navigation system, refer to page 132, or enter the distance manually in the computer, refer to page 87, prior to departure.

 A requirement is that you have correctly set the time in the Control Center, refer to page 90. ◀

Control Display screen contents

You can activate the computer function at any time by selecting it from the "Car data" menu.

You have two possibilities to display information of the computer:

- ▷ Computer
- ▷ Trip computer
Use this, for example, for driving on vacation, as when you reset the values to zero, all the functions are reset together and then restart.

Computer



- ▷ Time of arrival
- ▷ Distance to destination.
Enter a destination in the navigation system, or enter a distance in the computer manually, refer to page 132 or 87
- ▷ Cruising range
- ▷ Average fuel consumption
- ▷ Average speed.

 You can reset calculations of both average speed and average fuel consumption to zero. Select the menu item and confirm your selection. ◀

Trip computer



Reset all data to zero:
Select "START / RESET" and confirm your selection.

- ▷ Time of departure
- ▷ Driving time
- ▷ Elapsed distance
- ▷ Average fuel consumption since "START / RESET"
- ▷ Average speed since "START / RESET".

Entering a distance manually

1. Select "BC"
2. Select and activate the "Distance" entry function. Turn the controller to the left or right to select the distance to your destination
3. Press the controller to confirm your entry.



Speed limit

You can enter a speed and a Check Control message indicates when you have reached this speed. This enables you, for example, to receive warnings if you exceed a speed limit in an urban area.

You are only warned of reaching this speed a second time if you again drive at least 3 mph/5 km/h slower.

Adjusting, changing

1. Select "Limit" and confirm your selection
2. Select "SET" and confirm your selection



3. Turn the controller to the left or right to select the preset speed
4. Press the controller to confirm your entry. The speed limit function is now active.

Switching on or off

1. Select "Limit" and confirm your selection
2. Select "ON / OFF" and confirm your selection. "ON / OFF" is highlighted when the speed limit function is activated.

Applying your current speed as limit

1. Select "Limit" and confirm your selection
2. Select  and confirm your selection. The system applies your current speed as the limit.

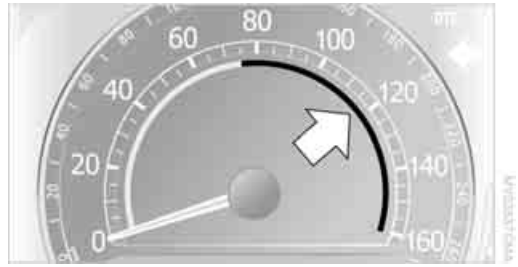

Limit on Info Display





If, for instance, the warning sector in the tachometer is visible, refer to page 81, the speed limit will be indicated by a warning sector in the speedometer, refer to arrow.

Stopwatch

Starting and stopping

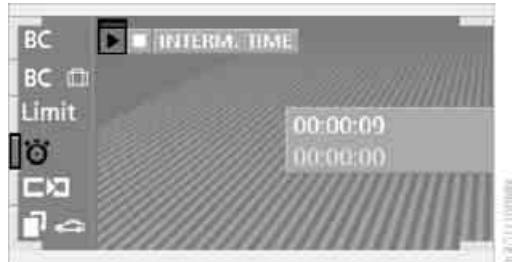
1. Select  and confirm your selection
2. Select  and confirm your selection. The stopwatch is reset to 0 and starts



3. Select  and confirm your selection. This stops the timer. Confirm again to reset the stopwatch to zero.

Taking an intermediate time reading

Select "INTERM. TIME" and confirm your selection. This intermediate time appears below the ongoing primary stopwatch count.

 All of the remaining functions remain available at all times while the stopwatch is running. The stopwatch continues operation in the background. ◀

Assistance window* for "Car data"

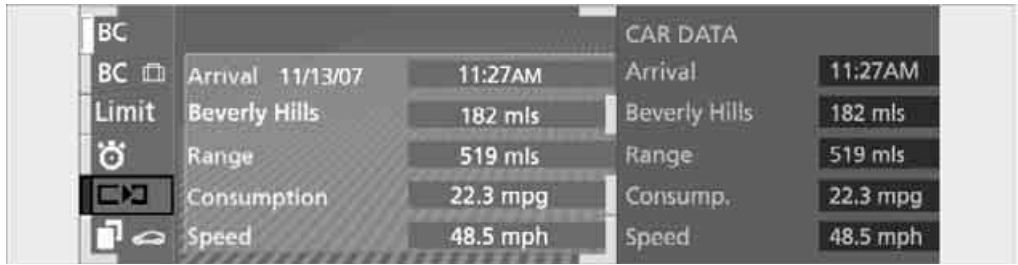

You can select any of the following computer functions for display in the assistance window:

- ▷ Computer
- ▷ Trip computer
- ▷ Speed limit
- ▷ Stopwatch.

Applying display

1. Select the desired function and confirm – here, computer "BC"
2. Select  and confirm your selection. The function appears in the assistance window.

 The symbol is highlighted if the function displayed in the assistance window is selected on the Control Display. ◀

You can also choose to view brief help texts explaining selected menu items, refer to page 22, or the travel route on vehicles equipped with a GPS navigation system, refer to page 131.

Changing settings

Units of measure and display format

You can select the units of measure used in the displays of fuel consumption, distances, temperatures and pressures as well as the display format for the time and date.

1. Select  and confirm your selection



2. Select the menu item that you wish to adjust. Press repeatedly to view a listing of your selection options.

Language

You can select a different language for the text displays.

1. Select  and confirm your selection
2. Select and activate the desired language.



Time and date



Select "Clock" and confirm your selection.

Setting time

Select "Time" and confirm your selection. The first setting sector is highlighted.

- ▷ Turn to reset
- ▷ Press to store your entry and proceed to the next setting.
The clock applies your entry the last time you confirm your entry.

Switching on memo mode

You will hear four tones just before each full hour.

- ▷ Select "Memo" and confirm your selection. "Memo" is highlighted when this function is activated.

Setting date

Select "Date" and confirm your selection. The first section of the date display is highlighted – here day.

- ▷ Turn to reset
- ▷ Press to store and highlight the next entry – here month and year.
Your date is applied by the system the last time you store your entry.

Brightness

You can set the brightness of the screen.

1. Select  and confirm your selection
2. Select "Brightness" and confirm your selection. Press and turn the controller to make the adjustment.

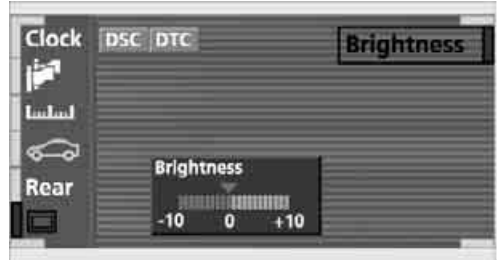

-  With unfavorable conditions, e.g. bright environment, the brightness control of the screen might not be immediately recognizable. ◀

Technology for comfort, convenience and safety

PDC Park Distance Control*

The concept

The PDC assists you when you are parking. Signal tones indicate the current distance to an object behind or in front of your vehicle. Four ultrasonic sensors in both the bumpers monitor the distance to the nearest object. The sensors at the front and at the two rear corners have a range of approx. 2 ft/60 cm; the rear middle sensors have approx. 5 ft/1.50 m.

 PDC is a parking aid that can indicate objects when they are approached slowly, as is usually the case when parking. Avoid approaching an object at high speed, as otherwise the physical circumstances would mean that the system warning was too late. ◀

Automatic function

Whenever the ignition is on the system automatically assumes operational status after a few seconds each time you engage the transmission position R.

 Wait this short period before reversing. ◀

Switching on manually

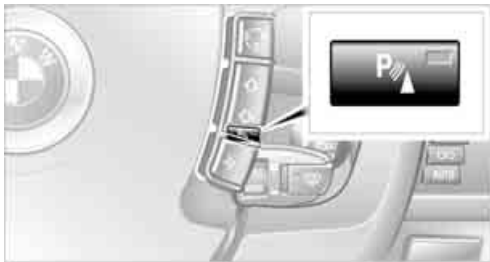

Press the button, the indicator lamp lights up.

Manual deactivation

Press the button again; the indicator lamp goes out.

Automatic deactivation

The system is automatically deactivated once the vehicle travels approx. 165 ft/ 50 m or exceeds a speed of roughly 20 mph/30 km/h; the indicator lamp goes out. You can reactivate the system manually as needed.

Signal tones

The signal indicating the distance to the nearest obstacle is directional. Thus, an object detected to the left rear of the vehicle will be indicated by a signal tone from the left rear speaker, etc. As the distance between vehicle and object decreases, the intervals between the tones become shorter. The signal tone becomes continuous once the distance to the nearest object falls to below roughly 1 ft/30 cm.

The warning signal is canceled after approx. 3 seconds if you are moving parallel to a wall.

Malfunction

The indicator lamp within the button flashes and a status message appears in the Check Control. PDC has failed. Switch off PDC. Have the system checked.

To prevent this problem, keep the sensors clean and free of ice or snow in order to ensure that they will continue to operate effectively.

PDC with visual warning



You also enjoy the option of having the system show distances to objects on the Control Display. The Control Display will also indicate the presence of objects in green before they are close enough to generate a signal tone.

Select "PDC pic." from the "Settings" menu and confirm your selection. This activates the PDC display.

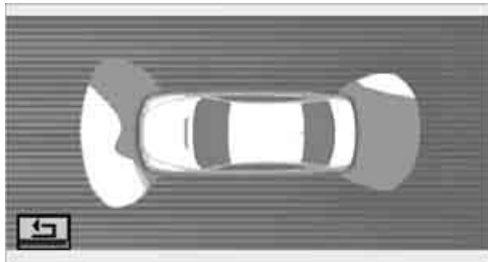

The display then appears on the Control Display whenever the PDC is automatically or manually activated.

The previous display automatically reappears after the system is deactivated.

 confirm to return to the previous display.

System limits

 Even with PDC, final responsibility for estimating the distance between the vehicle and any obstructions always remains with the driver. Even when sensors are involved, there is a blind spot in which objects cannot be detected. The system is also subject to the physical limits that apply to all forms of ultrasonic measurement, such as those encountered with tow bars and trailer couplings, as well as thin and

wedge-shaped objects, etc. Low objects already displayed, e.g. a curb, can also disappear from the detection area of the sensors again before a continuous tone sounds.

Loud noises from outside and inside the vehicle may prevent you from hearing the PDC's signal tone. ◀

 Keep the sensors clean and free of ice or snow in order to ensure that they will continue to operate effectively. Do not apply high pressure spray to the sensors for a prolonged period of time. Keep the spray at least 4 in/10 cm away from the sensors. ◀

Driving stability control systems

Your BMW is equipped with an extended array of systems designed to enhance and maintain vehicle stability under extreme conditions. The following section describes these functions based on DSC and ABS.

ABS Antilock Brake System

ABS enhances active safety by preventing the wheels from locking under braking.

ABS incorporates CBC and EBV.

Malfunction

 The warning lamp lights up yellow and ABS is switched off. Conventional braking efficiency remains available without limitations. Have the system checked as soon as possible.

CBC Cornering Brake Control

CBC is a supplement to ABS. It provides further enhancements in vehicle stability and steering response during lane changes and cornering at high rates of lateral acceleration.

EBV Electronic brake-force distribution

EBV controls the brake system's application pressure at the rear wheels to ensure stable deceleration.

DSC Dynamic Stability Control

The system optimizes vehicle stability during acceleration and when starting from a full stop, as well as optimizing traction. The system recognizes any tendency for the vehicle to assume an unstable attitude such as oversteer or understeer; it then counteracts this tendency with a combination of graduated reductions in engine torque and selective braking intervention at individual wheels. DSC provides optimized stability within the limits defined by the laws of physics.

The DSC is operational every time you start the engine. DSC contains the functions DTC Dynamic Traction Control and DBC Dynamic Brake Control.

Indicator lamp



The indicator lamp goes out shortly after the engine starts.

The indicator lamp flashes:

DSC controls the drive and braking forces.

The indicator lamp stays lit:

DSC has been switched off using the Control Center.

Activating DTC Dynamic Traction Control

In particular driving situations, in deep snow, for example, DTC ensures the maximum forward momentum. The gain in forward momentum in these situations involves a reduction in vehicle stability. DTC is active up to 45 mph/70 km/h.

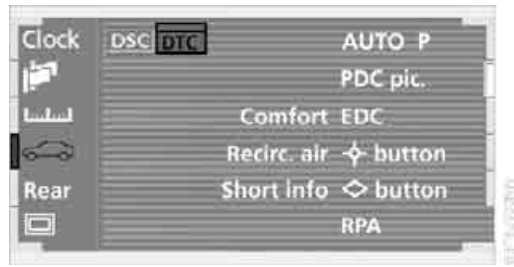

You may find it useful to briefly activate DTC under the following special circumstances:

- ▶ When rocking the vehicle and starting off in deep snow or on loose road surfaces
- ▶ When ascending snow-covered hills, and when driving in deep or on hard-packed snow
- ▶ When driving with snow chains.

Select "Settings". Select "DTC" and confirm your selection. DTC is now activated. The DTC indicator lamp in the Info Display lights up permanently.

 When DTC is active, DSC provides only limited system response up to a speed of approximately 45 mph/70 km/h. Intervention for stability enhancement is reduced. ◀

Deactivating DTC again

Select "Settings". Select "DTC" and confirm your selection. DTC is now deactivated. The DTC indicator lamp in the Info Display goes out. DSC is once again available without restriction.

Switching off DSC



Select "Settings". Select "DSC" and confirm your selection. DSC is deactivated. The indicator lamp in the Info Display remains on continuously.

Deactivating DSC automatically deactivates DTC as well. The systems for enhancing stability and traction are deactivated, and there is no active braking intervention or torque control.

A status report appears in the Check Control. Please take note of the additional information on the Control Display.

 To maintain optimized stability, drive with the system on whenever possible. ◀

Reactivating DSC

Select "Settings". Select "DSC" and confirm your selection. DSC is now activated. The indicator lamp in the Info Display goes out.

 The laws of physics cannot be repealed, even with DSC. An appropriate driving style always remains the responsibility of the driver. Avoid using the additional safety margin provided by the system as an excuse for taking unnecessary risks.

When DTC is active, DSC provides only limited system response up to a speed of approximately 45 mph/70 km/h. Intervention for stability enhancement is reduced. Do not make any modifications to the DSC system. Never allow anyone other than authorized professional technicians to carry out service or repairs on the DSC system. ◀

DBC Dynamic Brake Control

When you apply the brakes rapidly, this system automatically produces the maximum braking force boost and thus helps to achieve the shortest possible braking distance during panic stops. This system exploits all of the benefits provided by ABS.

Do not reduce the pressure on the brake pedal for the duration of the brake application. When the brake pedal is released, the DBC is deactivated.

Malfunction in vehicle stability control systems

 The brake system warning lamp lights up in red, appearing together with the indicator lamps for ABS and DSC. A status report appears in the Check Control. Please take note of the additional information on the Control Display. Driving stability control and ABS have failed. Conventional braking efficiency remains available without limitations.

While you may continue, you should remember to proceed cautiously and drive defensively while avoiding full brake applications. Have the system checked as soon as possible.

 Display of the previously described malfunction on Canadian models.

 ABS

 The DSC warning lamp lights up.

DSC and DTC have failed. Their stabilizing interventions are no longer available. The vehicle will remain completely operational, however, without DSC. Have the system checked as soon as possible.

 The brake system warning lamp lights up yellow and a message appears in the Check Control. Please take note of the additional information on the Control Display. DBC has failed.

Have the system checked as soon as possible.



Display of the previously described malfunction on Canadian models.

Dynamic Drive

The concept

Dynamic Drive minimizes body roll and optimizes vehicle stability during cornering and evasive maneuvers.

Active stabilizers at the front and rear axles form the basis for Dynamic Drive. Suspension compliance adapts to suit driving conditions, varying from performance-oriented during cornering to smooth and comfort-oriented when the vehicle is proceeding in a straight line.

The system assumes operational status each time you start the engine.

Driving with Dynamic Drive

During vehicle operation, the system continuously runs through closed-loop control cycles lasting only fractions of a second.

Malfunction



The warning lamp lights up, accompanied by a status message in the Check Control. Please take note of the additional information on the Control Display. A malfunction has occurred in the system. Have the system checked as soon as possible.



If the Dynamic Drive system switches off in response to malfunction, please remember to adapt your speed accordingly, especially in curves.

The suspension will be noticeably softer and the vehicle will display a greater tendency to tilt during cornering and in crosswinds.

If a Check Control message stating that you should stop appears in addition to the red symbol, stop immediately and switch off the engine. In this case the oil level in the reservoir may have dropped below the min-

imum, possibly owing to a leak in the hydraulic system. Please observe the additional instructions provided on the Control Display. ◀

EDC Electronic Damping Control*

The suspension responds to changes in factors such as road surface, or operating conditions such as steering and braking, by adapting to the new conditions within fractions of a second.

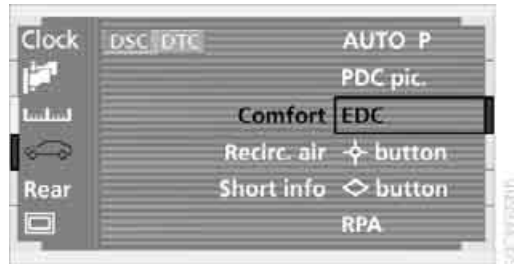

Two programs are available; they can be selected in the "Settings" menu.

Comfort mode

The Comfort mode is suitable for use throughout the vehicle's entire speed range and regardless of load.

Sport program

You should select the Sport program for consistently performance-oriented response from shock absorbers and steering.

Flat Tire Monitor

The concept

The Flat Tire Monitor keeps track of the inflation pressures in the four fitted tires as you drive. The system provides an alert whenever the inflation pressure drops significantly in relation to the pressure another tire.

The check of the tire inflation pressure is based on monitoring the relative speeds of the wheels. A flat tire is detected and reported on the basis of a deviation in certain speed ratios.

Functional requirements

So that the Flat Tire Monitor can learn the correct inflation pressure, please perform the following:

1. Check the inflation pressures in all tires
2. Compare with the inflation pressure table on page 189 and correct if necessary
3. Initialize the system.

System limits

 The Flat Tire Monitor cannot indicate sudden severe tire damage caused by outside factors and does not detect a natural, even pressure drop in all four tires. ◀

In the following situations, on the other hand, there can be delays in detecting tire pressure losses, and even system failure:

- ▶ When you are driving on snow-covered or slippery road surfaces
- ▶ In the case of performance-oriented driving: slip on the drive wheels, high lateral acceleration
- ▶ False alarms and undetected loss of pressure may occur when you are driving with snow chains fitted.

Initializing system

 Perform the initialization immediately after correcting the inflation pressure, changing a tire or changing a wheel or all wheels. A drive is necessary for this purpose. ◀

1. Start the engine, but do not drive off
2. Select "RPA" from the "Settings" menu and confirm your selection. The initialization menu appears

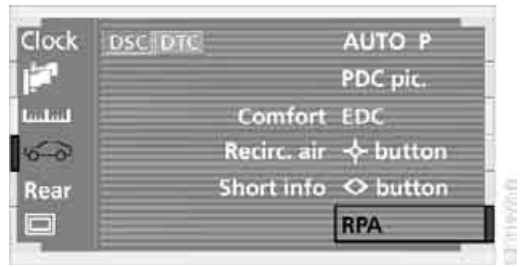

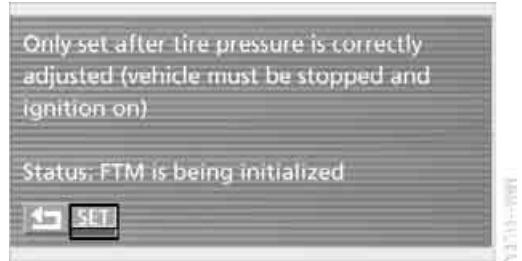

3. Select "SET" and confirm your selection
4. Drive off.



"FTM is being initialized" is displayed as the status.

It takes at least 10 minutes before the Flat Tire Monitor can detect and report a flat tire.

 When driving with snow chains, do not initialize the system. ◀

Select  and confirm to exit from the menu.

Indication of a flat tire

 The warning lamp lights up red, accompanied by a status message in the Check Control. In addition, an acoustic signal sounds. A flat tire or a major air loss has occurred.

1. Reduce speed and stop the vehicle carefully. Avoid sudden braking and steering maneuvers
2. Identify damaged tire
 -  If identification is not possible, contact your BMW center. ◀
3. Replace the damaged tire, refer to Changing wheels on page 204.

Vehicles with run-flat tires:

1. Cautiously reduce the vehicle speed to below 50 mph/80 km/h. Avoid sudden braking and steering maneuvers. Do not exceed a vehicle speed of 50 mph/80 km/h



Due to the reinforcement on the side walls of the run-flat tires, inflation pressure loss can not usually be recognized from the outside, refer to Run-flat tires on page 206. ◀

2. To continue driving, comply with the instructions for driving with damaged tires on page 206.

Malfunction



The indicator lamp lights up yellow, accompanied by a status message in the Check Control. The Flat Tire Monitor has malfunctioned or failed. Have the system checked as soon as possible.

Self-leveling suspension*

Malfunction



A Check Control message appearing together with this symbol indicates a malfunction in the self-leveling suspension. Please take note of the additional information on the Control Display.

Stop and inspect the vehicle. If the rear of the vehicle is visibly lower than the front, possibly accompanied by a tilt noticeable when you compare the left rear with the right rear, please respond by immediately proceeding to the nearest BMW center. Drive with appropriate caution in the meantime. The vehicle has reduced ground clearance and driving comfort may be noticeably reduced. Even if the attitude of the vehicle is normal, you should consult the nearest BMW center if the warning lamp indicates a system fault.

Brake Force Display

The Brake Force Display indicates the intensity with which you are applying your brakes to drivers of following vehicles.



The display consists of two stages:

- ▷ Normal braking:
The brake lamps in the tail lamp assemblies and the high-mount brake lamp on the rear tray light up during braking
- ▷ Heavy braking and braking with ABS:
The rear lamps also light up with the same intensity as the standard brake lamp units to enhance the warning effect of the brake lamps.

Airbags



The following airbags are located under the marked covers:

- 1 Front airbags for driver and front passenger
- 2 Head airbags in front and rear
- 3 Side airbags in front and rear*
- 4 Knee airbags for driver and front passenger

Protective effect

The front airbags help protect the driver and front passenger by responding to frontal impacts in which safety belts alone cannot provide adequate restraint. When needed, the head and side airbags help provide protection in the event of side impact. The side airbags help restrain the side of the occupant's upper torso, and the head airbags help support the head while also helping provide protection against any objects penetrating into the passenger compartment. The knee airbags help protect the legs against impact against the cockpit.

The airbags are deliberately not triggered in every impact situation, e.g. less severe accidents, certain roll-over conditions, or rear-end collisions.

 The rear seat side airbags may already have been deactivated by a BMW center. Labels in the rear door opening should indicate the status of your rear seat side airbags. If you are uncertain of their status, or wish to have the airbags activated or deactivated, please contact your BMW center. ◀

For information on the correct sitting position, refer to page 46.

 Do not apply adhesive materials to the cover panels of the airbags, cover them or modify them in any other way. Do not attempt to remove the airbag retention system from the vehicle. Never modify or tamper with either the wiring or the individual components in the airbag system. This category includes the upholstery in the center of the steering wheel, on the instrument panel, the doors and the roof pillars along with the sides of the headliner. Do not attempt to remove or dismantle the steering wheel.

Do not touch the individual components directly after the system has been triggered, because there is a danger of burns. In case of malfunctions, storage or after the airbag restraint system has been triggered, only have checking, repair or dismantling and the scrapping of the airbag generators carried out by a BMW center or a workshop that uses personnel trained in accordance with BMW requirements and equipped with the required explosives permits. Unprofessional attempts to service the system could lead to failure in an emergency or undesired airbag activation, either of which could result in personal injury. ◀

Airbag warning information is also provided on the sun visors.

Automatic deactivation of front passenger airbags

Your BMW has a seat occupation detection system. By evaluating the weight on the front passenger's seat, the system detects

whether or not the seat is occupied by a child in the child-restraint system or an adult.

- ▶ When a child is seated in the child-restraint system or with an empty seat, the front and side airbags are automatically deactivated on the passenger's side
- ▶ When an adult is traveling in the front seat, the front and side airbags remain active on the passenger side.

⚠ Although not desired, it can occur in the case of heavier children that the front passenger airbags remain active or in the case of very light adults or young persons that the front passenger airbags are deactivated.

The state of the front passenger airbags is shown with the indicator lamp, refer to Indicator lamps in the following. In this case transport the corresponding persons on the rear seat.

Except when persons to be transported, do not increase the load on the front passenger seat with additional items. Do not fit seat covers, seat cushion padding, ball mats or other items to the front passenger seat unless they are specifically recommended by BMW. Do not place any items under the seat. Otherwise, the function of the seat occupation detection could be impaired. ◀

Indicator lamps

Airbag system ready for use



The warning lamp indicates the operational readiness of the entire airbag system and the safety belt tensioners from the radio

position: the warning lamp goes out after a few seconds.



The indicator lamp above the interior rear-view mirror indicates whether the front-passenger airbag system is activated or deactivated as of ignition key radio position.

▶ The indicator lamp refers exclusively to the front-passenger airbag system. ◀

- ▶ The indicator lamp goes out after a few seconds.
The front passenger airbags are active, e.g. when transporting an adult
- ▶ The indicator lamp lights up continuously. The front passenger airbags are deactivated, e.g. when transporting a child in the child-restraint system or when the seat is unoccupied.

For more information on the operating principle of the front passenger airbag system and seat occupation detection, refer to Automatic deactivation of the front passenger airbags.

Airbag system malfunction

⚠ Have the airbag system checked immediately if a malfunction occurs, as otherwise there is a danger of the system failing to respond in the expected manner to an impact occurring within its normal response range. ◀

⚠ A fault has occurred in the airbag system:

- ▶ The warning lamp fails to come on as of ignition radio mode
- ▶ Warning lamp lights up continuously
- ▶ Warning lamp lights during driving.

Lamps

Parking lamps/low beams



Parking lamps

 With the switch in this position, the front, rear and side vehicle lighting is switched on. You can use the parking lamps for parking. For lighting on one side for parking as an additional feature, refer to page 101.

Low beams

 When you switch off the ignition with the headlamps on, the headlamps go out, and only the parking lamps remain on.

Pathway lighting

 After parking the vehicle and switching off the headlamps, you can use the headlamp flasher control to activate the low beams for a period of roughly 40 seconds. Pressing the button 4 on the remote control, refer to page 36, also switches on the low beams for approx. 40 seconds. In addition, the door handle and interior lamps are switched on for approx. 10 seconds. You can have the lighting up of the low beams extended or the function deactivated. ◀

Lights on warning

If you switch off the ignition while the headlamps are on, when you subsequently open the driver's door a gong will sound for several seconds, while the Check Control will provide you with a message.

Daytime driving lamps*

If you wish, you can leave the light switch in the low-beam position.

Always observe all applicable laws governing the use of daytime driving lamps.

You can switch on the parking lamps when needed using the standard procedure described under Parking lamps.

 You can have the daytime driving lamps on your vehicle programmed to operate as desired. ◀

Automatic headlamp control

 When you set the switch to this position, the system activates and switches on and off the low beams in response to changes in ambient light conditions, for instance, in tunnels, at dawn and dusk, and in rain and snow. The green indicator lamp next to the symbol is illuminated when the low beams are on.

 The low beams remain switched on regardless of the ambient light when you switch on the front fog lamps. ◀

 The automatic headlamp control cannot serve as a substitute for your personal judgment in determining when the lamps should be switched on in response to ambient lighting conditions. For example, the system cannot detect fog. To avoid safety risks, you should always switch on the lamps manually under these conditions. ◀

 You can have the sensitivity of the headlamp control system adjusted on your vehicle. ◀

Adaptive Head Light*

The concept

Adaptive Head Light is a variable headlamp control system that enables dynamic illumination of the road surface. Depending on the steering angle and other assumptions, the light from the headlamp follows the course of the road.

Activating Adaptive Head Light



With the ignition on, refer to page 62, turn the light switch to the position 'Automatic headlamp control', refer to page 100.

To avoid blinding oncoming traffic, the Adaptive Head Light:

- ▷ Is not active when driving in reverse
- ▷ Is only active toward the passenger's side with the vehicle stationary.

Malfunction

The LED above the symbol for automatic headlamp control flashes. Adaptive Head Light is faulty or has failed. Have the system checked as soon as possible.

High beams/standing lamps

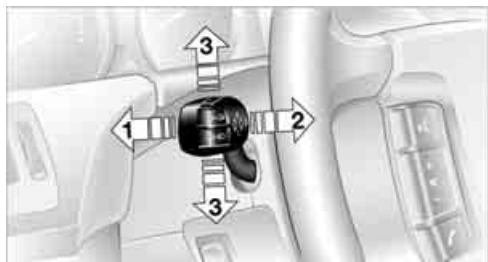

- 1 High beams
- 2 Headlamp flasher
- 3 Standing lamps

Standing lamps, left and right*

You also enjoy the option of lighting up just one side of your vehicle when parking:

With the ignition off, press the lever in the desired direction **3**, beyond the resistance point.

Front fog lamps



Briefly press the button once again to switch on/off.



The parking lamps or low beams must be switched on for the fog lamps to operate. The green indicator lamp in the Info Display lights up whenever the fog lamps are on.



If the automatic headlamp control is activated, the low beams will come on automatically when you switch on the fog lamps. ◀

Instrument lighting



Turn the serrated dial to adjust the illumination intensity.

Interior lamps

Control of the interior lamps, footwell lamps, courtesy lamps and ground lamps is automatic.

Switching interior lamps on and off



Briefly press button.

If you want the interior lamps to remain off continuously, maintain pressure on the button for approx. 3 seconds.

To revert to normal operation, briefly press the button.

The button for the interior lamps in the rear passenger area only switches these lamps on and off.

Reading lamps

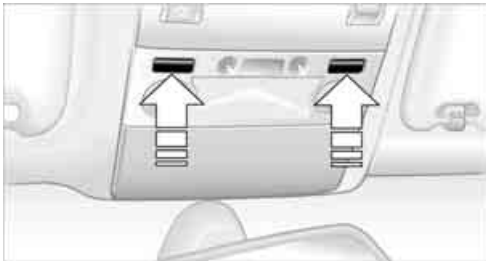

Reading lamps are provided in the front and rear, adjacent to the interior lamps. They can be switched on and off with the respective button located next to the them.

 To avoid discharging the battery, all of the vehicle's interior lamps are automatically extinguished approx. 15 minutes after the ignition is switched off. ◀

A congenial climate

Automatic climate control

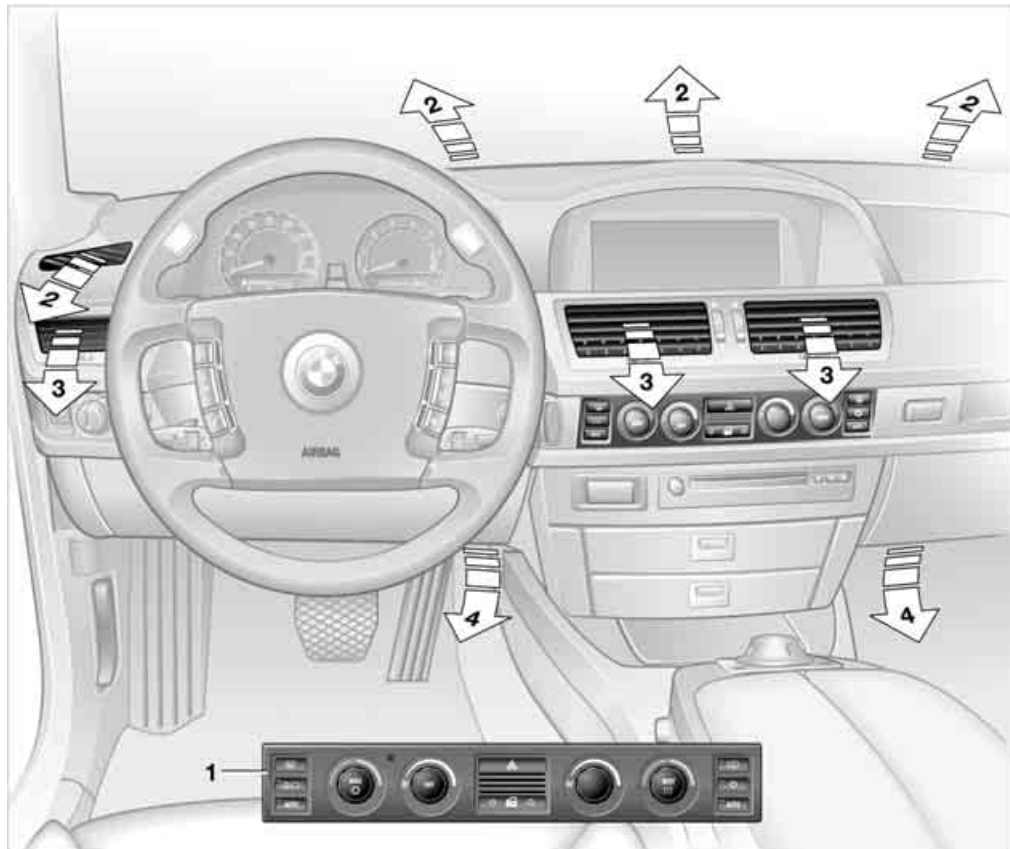

- 1 Automatic climate control
- 2 Airflow directed toward the windshield and side windows
- 3 Air for upper body area
The serrated dials in the center open and close through an infinitely-variable range to control air supply while also adjusting the air's direction like the lower serrated dials. You can find more information on adjusting for draft-free ventilation on page [108](#)
- 4 Air to footwell



- 1 Automatic air distribution and supply, left side of passenger compartment 107
- 2 Outside air/AUC/automatic recirculated-air control/recirculated air 105
- 3 Defrosting windows and removing condensation 105
- 4 Temperature, left side of passenger compartment 105
- 5 Maximum cooling 105
- 6 Air supply, left side of passenger compartment 105
- 7 Switching off automatic climate control 107
- 8 Air supply, right side of passenger compartment 105
- 9 Temperature, right side of passenger compartment 105
- 10 Residual heat mode 105
- 11 Rear window defroster

- 12 Switching air conditioner mode on and off manually 105
- 13 Automatic air distribution and supply, right side of passenger compartment 107
- 14 Air grill for interior temperature sensor – please keep clear and unobstructed
- 15 Independent ventilation 110
 - ▷ Activation time activated: the indicator lamp comes on
 - ▷ Independent ventilation switched on: the indicator lamp flashes

All other setting options for the automatic climate control can be found at "Settings" using the Control Center, refer to page 107.

The current settings for temperature and air supply are displayed to you in the status line of the Control Display. A description of the Control Center is provided on page 17. ◀

A congenial climate

Activate the automatic mode using the AUTO button or "AUTO" in the Control Center, refer to page 107. Select an interior temperature you find pleasant.

The following section contains more detailed information on the available setting options.

All of the air conditioning functions, including Maximum cooling, refer to page 105, and the Rear air conditioner, refer to page 109, are available only when the engine is running. ◀

Your vehicle has been designed to automatically select your personal climate-control settings whenever you

unlock the doors using your individually programmed remote control. ◀

Automatic air distribution and supply

The AUTO program adjusts the airflow and distribution patterns for you while also using your preselected temperature setting as the basis for adjusting the interior climate to adapt to external influences: summer, winter.

The air conditioner comes on automatically when you select the AUTO program.

Temperature adjustment



You can turn to select the desired temperatures for the driver's and passenger sides. Your settings appear on the Control Display's status line.

The figures in the display provide a general indication of interior temperature. When you start the vehicle, this system ensures that the selected temperature is achieved as quickly as possible. It then maintains this temperature, regardless of the season.

Defrosting windows and removing condensation



This program quickly removes ice and condensation from the windshield and door windows.

Adjusting air supply manually



You can adjust the air supply by turning. The automatic air supply control is operational whenever you see your selection represented by a bar on the

Control Display's status line. The automatic air distribution remains in operation as before. You can reactivate the automatic air supply mode with the AUTO button.

Switching air conditioner mode on and off manually



The air conditioner cools and dehumidifies the incoming air before also reheating it as required, according to temperature setting. Depending on the weather, the windshield may fog over briefly when the engine is started.

The air conditioner comes on automatically when you select the AUTO program.

Maximum cooling



This program quickly provides maximum cooling.

The temperature display reverts to 60 °F/16 °C while the system switches to the recirculated-air mode and starts to provide maximum air supply

through the vent outlets only. For this reason you should ensure that these outlets are open before selecting this program.

Outside air/AUC Automatic recirculated-air control/recirculated air



You can respond to unpleasant odors or pollutants in the immediate environment by temporarily suspending the supply of outside air. The system then recirculates the air currently within the vehicle. AUC executes this function automatically.

Press the button repeatedly to run through the following control sequence:

- ▷ Indicator lamps off: outside air flows into the vehicle
- ▷ Left indicator lamp on, AUC mode: the system detects pollutants in the outside air and responds by blocking the supply of outside air when required. The system then recirculates the air currently within the vehicle. Depending upon air quality, in the automatic mode the system may start to alternate between its outside-air and recirculated-air modes
- ▷ Right indicator lamp on, recirculated-air mode: the supply of outside air into the vehicle is permanently blocked. The system then recirculates the air currently within the vehicle.



If condensation starts to form on the inside window surfaces during operation in the recirculated-air mode, you should switch it off while also increasing air supply as required. ◀

Residual heat mode



The system uses the warmth stored in the engine to heat the interior when the ignition is off, for instance, while the vehicle is stopped at a school to pick up a child.

You can adjust the automatic climate control's settings when the ignition lock is in the radio mode. The system blows heated

air into the interior in accordance with the selected distribution pattern while the ignition is off.

▶ Provided that the engine has warmed to its normal operating temperature and the battery is charged, you can use this function for up to 15 minutes after switching off the ignition. The LED within the button lights up to confirm compliance with both of these conditions. ◀

Front ventilation

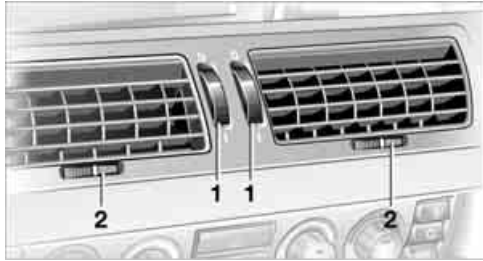

You can adjust the vent outlets for the upper body to suit your personal requirements.

You can use the serrated dials **1** to open and close the outlets through an infinitely-variable range, while the serrated dials **2** allow you to adjust the airflow direction.

Ventilation for cooling

Adjust the vents to direct the flow of cool air in your direction, for instance, if the interior has become too warm, etc.

Draft-free ventilation

Set the vent outlets so that the air flows past you and is not directed straight at you.

▶ You can also individually adjust the air temperature of the air vents for the upper body area in the Control Center, refer to page 108.

If the ventilation grill is completely closed, the vehicle interior is ventilated indirectly by air vents on the upper side of the cockpit. ◀

Ventilation for storage compartment in front armrest

You can use the serrated dial in the storage compartment to open and close the vent.

▶ Depending upon the temperatures selected at the rear dials, high temperatures may occur in the storage compartment. Close the vent as required. ◀

Ventilation in the rear



The serrated dials **1** allow you to open and close the ventilation outlets through an infinitely-variable range.

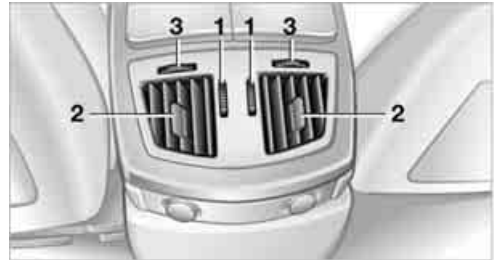

You can adjust the airflow direction using the levers **2**.

The serrated dials **3*** control the amount of cooled air in the flow from the vent outlets:

Turn towards blue: colder

Turn towards red: warmer.

This function allows you to make minor adjustments for maximum comfort while also letting you vary temperatures within the storage compartment.

Switching off automatic climate control*



The air supply, the heater and the air conditioner are all switched off. You can restart the automatic climate control by pressing any of its buttons except the REST button.

Settings using Control Center

With the ignition on, select "Climate". You can use the Control Center to set the following:



- ▷ "Left • Right": Separate settings for driver and front passenger
- ▷ Adjusting and adapting air-distribution patterns, refer to the next column
- ▷ Adjusting temperature for the upper body, refer to page 108
- ▷ Storing and calling up an individual setting for interior ventilation outlets, air distribution and temperature, refer to page 108.

☑ Select the second page of the "Climate" menu.

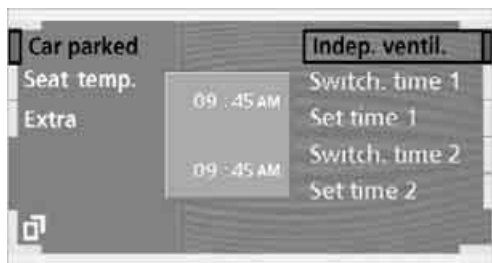

- ▷ "Indep. ventil.": For information on activating and deac-

tivating the independent ventilation and setting the timer, refer to page 110

- ▷ "Seat temp.": Adjusting temperature distribution while the seat heaters are on, refer to page 52
 - ▷ "Extra": Switching the rear air conditioning or rear cooler on and off, refer to pages 109 and 114.
- ☑ Select the first page of the "Climate" menu.

Automatic air distribution and supply

"AUTO":

The AUTO program adjusts the airflow and distribution patterns for you while also using your preselected temperature setting as the basis for adjusting the interior climate to adapt to external influences: summer, winter.

"Bi-Level":

This program operates in the same way as the AUTO program, but with airflow directed toward upper body and into the footwells.

Combining air distribution yourself



You can cancel the AUTO program by selecting specific air distribution patterns for your personal comfort.

Adjusting air distribution

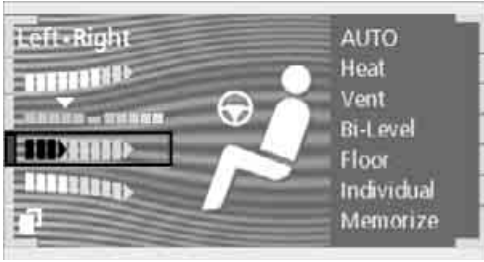

You also enjoy the option of adjusting the air distribution manually to obtain a climate that is ideally adapted to your personal requirements. The AUTO program is deactivated.

Select the desired symbol and confirm your selection. Turn the controller to adjust the air distribution.



Air on windshield and side windows.

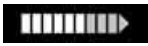

Air to the upper body. You can also adjust individually the air temperature of the vent outlets for the upper body, see below.



Air to footwell.

Adjusting temperature the upper body

This function provides you with the option of making minor adjustments to achieve maximum comfort.



Use the temperature setting to adjust the amount of cool air that is added to the air-flow emerging from the vent outlets for the upper body. We recommend a moderate

temperature setting, as cooler air helps promote fatigue-free driving.

Storing and calling up an individual setting



You can store your individual setting after adjusting the air distribution manually.

Select "Memorize" and confirm your selection.

Now you can reselect the preset climate that precisely reflects your personal requirements.



Select "Individual" and confirm your selection. The AUTO program is deactivated.

Microfilter/activated-charcoal filter

The microfilter removes dust and pollen from the incoming air. The activated-charcoal filter provides additional protection by filtering gaseous pollutants from the outside air. Your BMW center replaces this combined filter as a standard part of your scheduled maintenance.

You can select a display of more detailed information in the service requirement display, refer to page 82.

Rear air conditioner*

The following settings and operating modes can be selected and adjusted separately on the left and right sides:

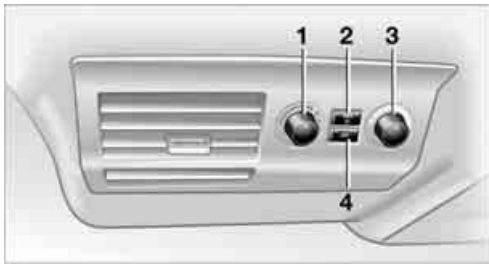

- 1 Adjusting cooling
- 2 Maximum cooling
- 3 Adjusting air supply manually
- 4 Switching off rear air conditioner

Switching on rear air conditioner

To switch on the rear air conditioner

- ▶ select maximum cooling **2**
- ▶ press the OFF button **4** again
- ▶ select "Rear air cond." in the Control Center and confirm, refer to Switching on and off using the Control Center.

 When you switch on the rear air conditioner, you simultaneously switch on the rear cooler, refer to page [114](#). ◀

Adjusting cooling



You can also set the system to provide the desired level of cooling by turning. We recommend setting the system for moderate cooling. When you start the vehicle, this system ensures that the selected setting is achieved as quickly as possible. It then maintains this temperature, regardless of the season.

Adjusting air supply manually



You can adjust the air supply by turning.

Maximum cooling



This program quickly provides maximum cooling.

The system automatically switches to the recirculated-air mode while a high-speed stream of air simultaneously emerges from the vent outlets. For this reason you should ensure that these outlets are open before selecting this program.

Switching off rear air conditioner





The air conditioner is switched off.

Press the button again to switch back on.

Switching on/off using Control Center

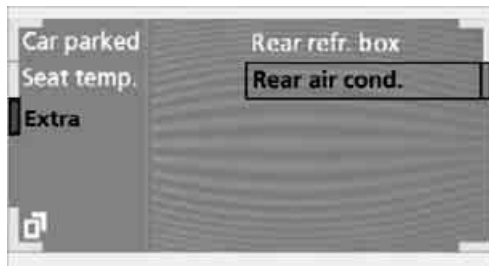
1. With the ignition on, select "Climate"
2. Select  and confirm the selection to change to the second page of the "Climate" menu
3. Select "Extra" and confirm your selection
4. Select "Rear air cond." and confirm your selection.



 The maximum cooling mode is automatically activated when you switch on the rear air conditioner in the Control Center. ◀

Select "Rear air cond." again and confirm your selection to switch off the system.

Rear ventilation



Use the lever **1** to vary the airflow direction. For additional information on rear ventilation options, refer to page [106](#).

Independent ventilation

System operation is controlled using the Control Center. You can set two different times for the system to start.

The independent ventilation blows air into the passenger compartment to lower interior temperatures.

The system remains on for 30 minutes. You can also switch the system on and off manually. Since the system uses a substantial amount of electrical current, you should refrain from activating it twice in succession without allowing the battery to be recharged in normal operation between use.

The independent ventilation is available for preprogrammed operation at outside temperatures above approx. 59 °F/15 °C and for direct activation at any temperature, but is not operational when the vehicle is underway.

The air enters the passenger compartment through the vent outlets in the dashboard, which can be adjusted for both direction and airflow. These outlets must be open for the system to operate.

Switching on and off directly

1. Activate the radio mode at the ignition lock
2. Select "Indep. ventil." on the second page of the "Climate" menu and confirm your selection.

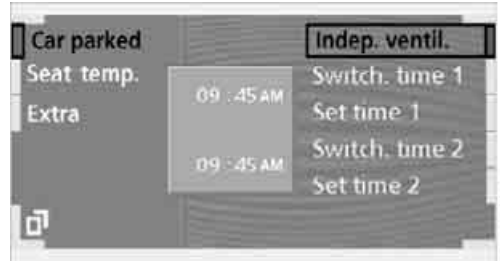

Select "Indep. ventil." a second time and confirm to deactivate the system manually.

Preselecting switch-on time

You can preselect two activation times.

1. Activate the radio mode at the ignition lock
2. Select "Indep. ventil." on the second page of the "Climate" menu.
3. Select "Set time 1" or "Set time 2" and confirm your selection
4. Enter the desired time
 - ▷ Turn: set
 - ▷ Press: confirm.



Activating timer

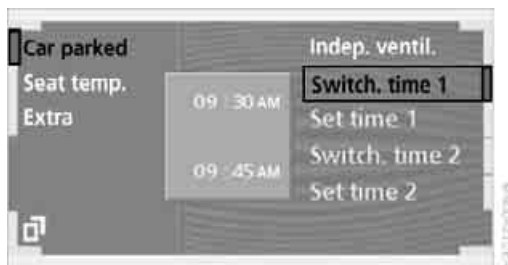

Select "Switch, time 1" or "Switch, time 2" and confirm your selection.

 The independent ventilation is only available for activation within the subsequent 24 hours. After this, the time will have to be reconfirmed. ◀

Practical interior accessories

Integrated universal remote control*

The concept

The integrated universal remote control can replace as many as three hand-held transmitters for various remote-controlled accessories, such as door openers and house alarm systems. The integrated universal remote control registers and stores signals from the original hand-held transmitters.

The signal of an original hand-held transmitter can be programmed on one of the three memory keys **1**. Following that, each of the devices can be actuated with the appropriately-programmed memory key **1**. The indicator lamp **2** flashes to confirm transmission of the signal.

Should you sell your vehicle one day, be sure to delete the stored programs beforehand for your safety, refer to page **113**.

 To prevent possible damage or injury, before programming or using the integrated universal remote control, always inspect the immediate area to make certain that no people, animals or objects are within the swiveling and movement range of the device. Also, comply with the safety precautions of the original hand-held transmitter. ◀

Checking compatibility

 If you see this symbol on the packaging or in the manual supplied with the original hand-held transmitter, it is safe to assume that it is compatible with the integrated universal remote control.

 If you have additional questions, please consult your BMW center or call 1-800-355-3515.

You can also visit these websites:
www.bmwusa.com or
www.homelink.com.

HomeLink is a registered trademark owned by Johnson Controls, Inc. ◀

Programming

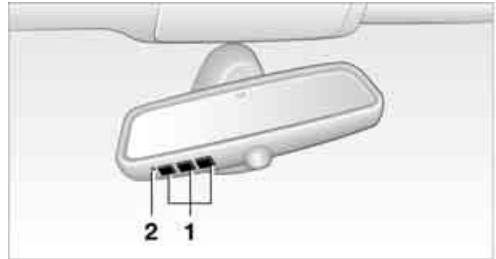

- 1** Memory keys
- 2** Indicator lamp

Fixed-code hand-held transmitter

1. Switch on the ignition
2. When using for the first time: press both outer keys **1** for approx. 20 seconds, maintaining pressure until the indicator lamp **2** starts to flash. The three memory keys **1** are cleared
3. Hold the original hand-held transmitter at a distance of approx. 2 in/5 cm to 8 in/20 cm from the memory keys **1**

 The required distance between the hand-held transmitter and memory keys **1** depends on the relevant system of the original hand-held transmitter used. ◀

4. Simultaneously press the transmit key on the original hand-held transmitter and the desired memory key **1** of the integrated universal remote control. Initially, the indicator lamp **2** flashes slowly. Release both keys as soon as the indicator **2** lamp flashes rapidly. If the indicator lamp **2** does not flash rapidly after approx. 15 seconds, change the distance
5. To program other original hand-held transmitters, repeat steps 3 and 4.

The corresponding memory key **1** is now programmed with the signal of the original hand-held transmitter.

The device can be operated as of ignition on.

 If the device can not be operated after repeated programming, check whether the original hand-held transmitter uses an alternating-code system. To do so, either read the instructions of the original hand-held transmitter or press and hold down the programmed memory key **1** of the integrated universal remote control. If the indicator lamp **2** on the integrated universal remote control flashes quickly for a brief period and then remains lit up for approx. two seconds, this indicates that the original hand-held transmitter is equipped with an alternating-code system. In the case of an alternating-code system, program the memory keys **1** as described at the section on alternating-code transmitters. ◀

Alternating-code transmitters

Consult the operating instructions of the unit you wish to set when programming the universal remote control. You will find information there on the possibilities for synchronization.

When programming hand-held transmitters that employ an alternating code, please observe the following supplementary instructions:

 Programming will be easier with the aid of a second person. ◀

1. Park your vehicle within the range of the remote-controlled device
2. Program the integrated universal remote control as described at the section on fixed-code hand-held transmitters
3. Localize the key on the receiver of the device you want to set up, e.g. on the upper section of the motor
4. Press the key on the receiver of the device you want to set up. After step 4, you have approx. 30 seconds for step 5

5. Press the programmed memory key **1** on the integrated universal remote control three times.

The corresponding memory key **1** is now programmed with the signal of the original hand-held transmitter.

 If you have any additional questions, please contact your BMW center. ◀

Clearing memory keys

Individual memory keys **1** can not be cleared. However, you clear all three memory keys **1** together as follows:

Press both outer keys **1** of the integrated universal remote control for approx. 20 seconds, maintaining pressure until the indicator lamp **2** starts to flash.

Roller sun blinds*

Rear window blind

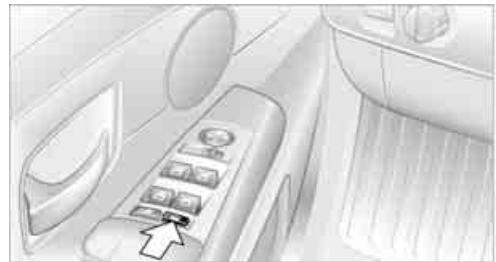

To actuate as of radio mode, briefly press the button in the driver's door.

Roller sun blinds for rear side windows

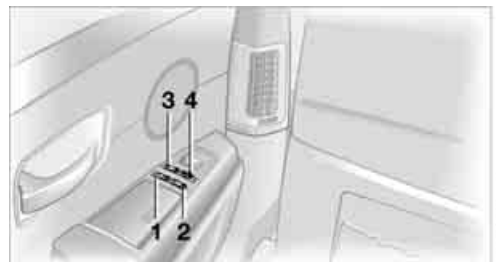

Activate by briefly pressing the desired button with the ignition lock as of radio mode.

- 1 Quarter window blind
- 2 Side window blind
- 3 Rear window blind
- 4 Switching to the other side

 The side window blind can not be extended unless the side window is closed. If the window is open, the blind will rise slightly prior to immediately retracting to its original position. ◀

 Briefly press the safety switch in the driver's door, refer to page 44. The indicator lamp must light up. This precaution prevents children from operating the sun blinds using the rear switches, etc. Before using always ensure that the sun blind's travel path is clear and unobstructed.

When leaving the vehicle, always remove the remote control from the ignition lock and close the doors; this precaution prevents children from using the sun blinds and injuring themselves, etc. ◀

Automatically extending and retracting sun blinds

You can extend and retract the sun blinds together by pressing and holding button 3 or the button in the driver's door.

Rear cooler*

The rear cooler is located behind the rear seats' center armrest.

Switching on/off



From radio mode, press the button until the indicator lamp in the button lights up.

 Vehicles with rear air conditioner:
Once switched on, the rear cooler operates whenever the engine is running. High temperatures in the luggage compartment can affect the temperature in the rear cooler.

Vehicles without rear air conditioner:
After the ignition has been switched off, the rear cooler is switched off automatically after a short period.

When a low voltage is reached, it is automatically switched off to protect the vehicle battery. The indicator lamp in the button flashes.

In the event of a malfunction, please contact your BMW center. ◀

Press the button again to switch off the rear cooler.

Opening



Pull on the opener and fold the cooler box forward.

Switching on/off using Control Center*

 When the rear air conditioner unit is switched on, the rear cooler operates whenever the engine is running. ◀

1. With the ignition on, select "Climate"
2.  Select the second page of the "Climate" menu
3. Select "Extra" and confirm your selection
4. Select "Rear refr. box" and confirm your selection.

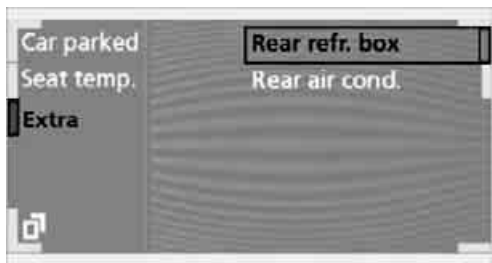

Select "Rear refr. box" a second time and confirm to switch the unit off.

Glove compartment

Opening

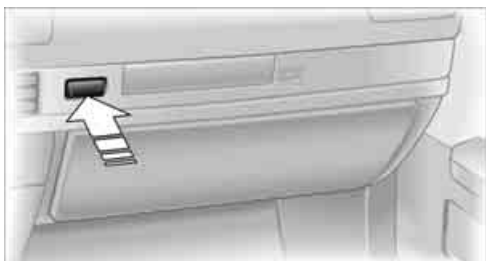

Press button. The glove compartment opens automatically and the lamps come on.

Closing

Fold the cover up.

⚠ To prevent injury in the event of an accident, close the glove compartment immediately after use. ◀

Rechargeable flashlight

The flashlight is located on the left side of the glove compartment. It features integral overload protection, so it can be left in its holder continuously.

⚠ Be sure that the flashlight is switched off when it is inserted into its holder. Failure to comply with this precaution could lead to overcharging and damage. ◀

Front center armrest

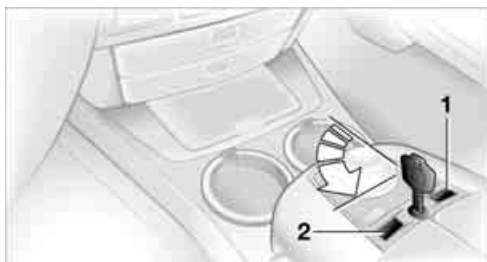

A storage compartment is located in the armrest between the front seats.

- 1 Open the right cover
- 2 Open the left cover

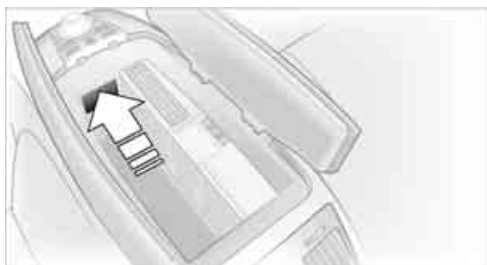

A removable coin holder is provided in the front of the compartment. Briefly press to open.

The mat within the compartment can be removed for cleaning.

Depending upon your model specification, any of the following may be located in the storage compartment:

- ▷ Removable CD holder*
- ▷ Fold-out and removable storage compartment*, e.g. for glasses or portable phone
- ▷ Fold-out and removable litter container*.

Locking storage compartment in front armrest

You can use the key to lock the storage compartment in the armrest.

▷ You can lock the luggage compartment lid and the armrest storage compartment separately, refer to page 40,

and then retain the key in your possession while handing over only the remote control when leaving the vehicle for valet parking etc., refer to page 34; this prevents unauthorized access to the luggage and front storage compartments. ◀

Ventilating storage compartment in front armrest

You can use the serrated dial in the storage compartment to open and close the vent.

▶ Depending on the automatic climate control setting, the temperature within the storage compartment may be higher than in the rest of the interior. Close the vent as required. ◀

Storage compartments

Glasses compartment



To open the compartment:
Briefly press the button.

You can remove the insert tray for cleaning.

Storage compartment in center console



To open the compartment:
Briefly press the button.

Clothes hooks

⚠ When suspending clothing from the hooks ensure that it will not obstruct the driver's vision. Do not hang heavy objects on the hooks. If you do so, they could cause personal injury to occupants during braking or evasive maneuvers. ◀

Beverage holders

Front



Below the sliding covers.

⚠ Do not place glass containers in the beverage holders, as otherwise there is a danger of injury in an accident. ◀

Rear



In the front of the rear seat cushion's center.

Briefly press to open; slide back to close.

Ashtray, front

Opening



Slide back the cover by the recess.

To extinguish a cigarette, tap off the ash and gently press the tip into the funnel.

Emptying

Press the button, refer to arrow 1. The ashtray rises for removal.

Cigarette lighter, front



Push down.

The lighter can be removed as soon as it jumps back out.

⚠ Hold or touch the hot cigarette lighter by the knob only. Holding or touching it in other areas could result in burns. The cigarette lighter is also ready for operation when the remote control is unlocked. For this reason, do not leave unsupervised children in the vehicle. ◀

Power socket

The cigarette lighter socket can be used with the ignition switched on to plug in hand flashlights, car vacuum cleaners etc. with power ratings of up to approx. 200 W at 12 V. Avoid damaging the socket due to inserting plugs of different shapes or sizes.

▶ With the ignition switched off, the power supply to all electrical sockets is cut off after approx. one hour. ◀

Power socket



An additional power socket is located in the front passenger's footwell.

To gain access, fold the cover cap up.

Ashtray, rear

Emptying



Press the cover entirely down. The ashtray rises for removal.

Cigarette lighter, rear



Refer to Cigarette lighter, front.

Rear center armrest

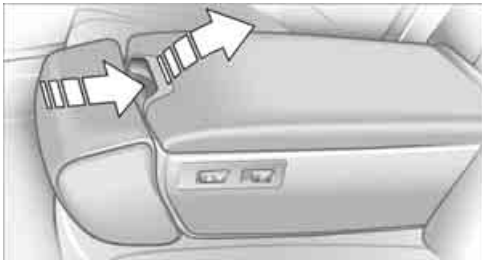

▶ Before folding down the armrest, adjust the head restraint to its lowest position, refer to page 50. ◀

To open the storage compartment:
Press the button in the handle recess and fold up the cover.

Comfort seat in rear



▶ Before folding down the armrest, adjust the head restraint to its lowest position, refer to page 50. ◀

To open the storage compartment:
Press the button and fold up the cover.

Ski bag*

Designed for safe, convenient transport of up to 4 pairs of standard skis or up to 2 snowboards.

The ski bag itself plus the additional capacity provided by the luggage compartment make it possible to transport skis with a length of up to 6.9 ft/2.10 m. When skis of 6.9 ft/2.10 m in length are loaded the ski bag will tend to contract, reducing its overall capacity.

Loading

1. Lower the center armrest, open the cover and place it on the armrest

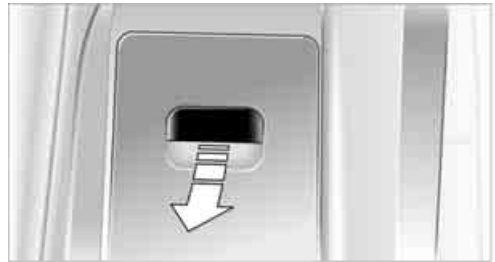

2. Remove the cover panel* and place it on the controller in the rear



3. To open the hatch in the luggage compartment:
Press the handle and slide it to the right

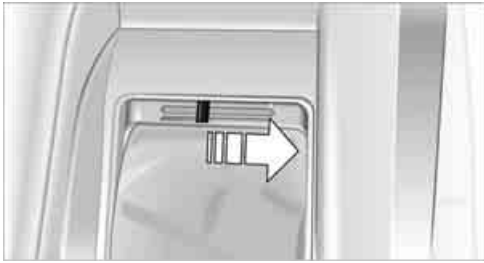

4. Extend the ski bag between the front seats. The zipper allows more convenient access to stored objects and can also be left open to allow the ski bag to dry.

Please ensure that the skis are clean before loading them into the bag. Take care to avoid damage from sharp edges.

Securing load



After loading, secure the ski bag and its contents. Tension the retaining strap on the tensioning buckle for this purpose.

⚠ Secure the ski bag in this way. If you fail to do so, it could endanger occupants during braking or evasive maneuvers. ◀

Stowing ski bag

1. To close the hatch in the luggage compartment:
Press the handle and slide to the left
2. Fold up the ski bag and place it in the compartment

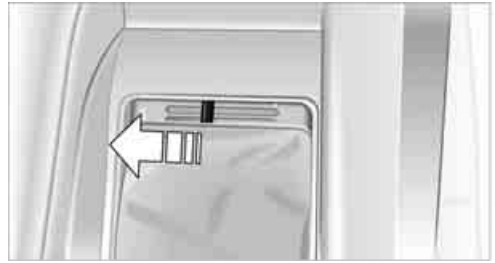

3. Engage the cover as shown



4. Close the cover.



Driving tips

This chapter is designed to provide you with extra support by supplying information useful in dealing with specific driving and operating conditions.

Things to remember when driving

Break-in procedures

To ensure that your vehicle continues to furnish optimized economy of operation throughout an extended service life, we request that you devote careful attention to the following information.

Engine and differential

Up to 1,200 miles/2,000 km:
During this initial period you should attempt to avoid constant, steady-state operation and vary both vehicle and engine speeds as often as possible. Until the break-in period has been completed you should also refrain from exceeding the following:

- ▷ 4,500 rpm or 105 mph/170 km/h

Always obey all official speed limits.

Avoid full-throttle operation and use of the transmission's kick-down mode during these initial miles.

Once you have driven 1,200 miles/2,000 km, the engine or vehicle speeds can be gradually increased.

Tires

Due to technical factors associated with their manufacture, tires do not achieve their full traction potential until after an initial break-in period. Therefore, drive reservedly during the first 200 miles/300 km.

Brake system

Brakes require an initial break-in period of approx. 300 miles/500 km to achieve optimized contact and wear patterns between brake pads and rotors.

Following component replacements

Observe the break-in instructions again if previously addressed components must be replaced again during driving later.

General driving notes

Hot exhaust system



Extreme temperatures occur at the catalytic converter on this and every catalyst-equipped vehicle. Do not remove the heat shields installed adjacent to various sections of the exhaust system, and never apply undercoating to them. When driving, standing at idle and while parking take care to avoid possible contact between the hot exhaust system and any highly flammable materials such as hay, leaves, grass, etc. Such contact could lead to a fire, accompanied by the risk of serious property damage as well as personal injury. ◀

Air conditioning

Condensation forms in the air conditioner system during operation, and then exits under the vehicle. Traces of condensed water under the vehicle are thus normal.

Before driving into a car wash

1. Fold in the exterior mirrors, refer to page 53, as otherwise they could be damaged due to the width of the vehicle
2. Leave the remote control in the ignition lock, as otherwise the P position of the automatic transmission will automatically be selected when the remote control is removed. Refer to page 63 and 69.
With Comfort Access, be sure to observe the instructions on page 63
3. Release the parking brake, especially when you have activated Automatic Hold. Refer to page 64 and 65.

Hydroplaning

 When driving on wet or slushy roads, reduce road speed. If you do not, a wedge of water can form between tires and road surface. This phenomenon is referred to as hydroplaning, and is characterized by a partial or complete loss of contact between tires and road surface, ultimately undermining your ability to steer and brake the vehicle. ◀

Driving through water

 Only drive through water with a maximum depth of 1 ft/30 cm, and then only at walking speed at the most. Otherwise, the vehicle's engine, the electrical systems and the transmission may be damaged. ◀

Safe braking

Your BMW is equipped with ABS as standard equipment. The best way to brake is to apply maximum pressure to the brake pedal during emergency: full brake application. Since the vehicle maintains steering responsiveness, you can nevertheless avoid possible obstacles with a minimum of steering effort.

Pulsation at the brake pedal combines with sounds from the hydraulic circuits to indicate to the driver that ABS is in its active mode.

Driving in wet conditions

While driving in wet conditions and in heavy rain, it is a good idea to apply light pressure to the brake pedal every few miles. Monitor traffic conditions to ensure that this maneuver does not endanger other road users. The heat generated in this process helps dry the pads and rotors to ensure that full braking efficiency will then be available when you need it.

Hills

 To prevent overheating and reduced efficiency of the brake system, drive long or steep downhill gradients in the gear in which the least braking is required.

Otherwise, even light but consistent pedal pressure can lead to high temperatures, brake wear and possibly even brake failure. ◀

You can further enhance the engine's braking effect by selecting a lower gear in the automatic transmission's manual mode, downshifting as far as first gear on extremely steep stretches, refer to page 70. This strategy helps you avoid placing excessive loads on the brake system.

 Never allow the vehicle to coast with the transmission in Neutral – or with the engine switched off – as there is no engine braking when the transmission is in Neutral, and no power-assist for brakes and steering when the engine is not running.

Never allow floor mats, carpets or any other objects to protrude into the area around the accelerator and brake pedals and obstruct their movement. ◀

Corrosion on brake rotors

When the vehicle is driven only occasionally, during extended periods when the vehicle is not used at all, and in operating conditions where brake applications are less frequent, there is an increased tendency for corrosion to form on rotors, while contaminants accumulate on the brake pads. This occurs because the minimal pressure which must be exerted by the pads during brake applications to clean the rotors is not reached.

Should corrosion form on the brake rotors, the brakes will tend to respond with a pulsating effect that even extended application will fail to cure.

Mobile communications devices in vehicle

 BMW does not recommend using mobile communications devices, e.g. portable phones, in the interior of the vehicle without a direct connection to an outside antenna. Otherwise the vehicle electronics and mobile communications device can affect each other. In addition, it is not

ensured that the radiation which results during transmission will be discharged from the vehicle interior. ◀

Cargo loading

 To avoid loading the tires beyond their approved carrying capacity, never overload the vehicle. Overloading can lead to overheating and increases the rate at which damage develops inside the tires. The ultimate result can assume the form of a sudden air loss. ◀

Determine loading limit



1. Locate the following statement on your vehicle's door pillar*:

 The combined weight of occupants and cargo should never exceed XXX lbs. or YYY kg, as otherwise the vehicle may be damaged and unstable driving conditions may result. ◀

2. Determine the combined weight of the driver and passenger that will be riding in your vehicle
3. Subtract the combined weight of the driver and passenger from XXX lbs. or YYY kg
4. The resulting figure equals the available amount of cargo and luggage load capacity.
For example, if the XXX amount equals 1,400 lbs. and there will be five 150-lbs. passengers in your vehicle, the amount of available cargo and luggage load capacity is 650 lbs.:
1,400 lbs. minus 750 lbs. = 650 lbs.

5. Determine the combined weight of luggage and cargo being loaded on the vehicle. That weight should not exceed the available cargo and luggage load capacity calculated in step 4
6. If your vehicle will be towing a trailer, part of the load from your trailer will be transferred to your vehicle. Consult the manual for transporting a trailer to determine how this may reduce the available cargo and luggage load capacity of your vehicle.

Load

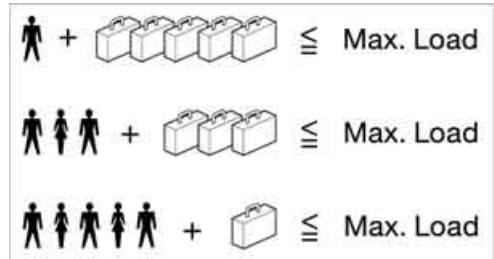

The permitted load is the total of the weight of occupants and cargo/luggage. The greater the weight of occupants, the less cargo/luggage can be transported.

Stowing cargo

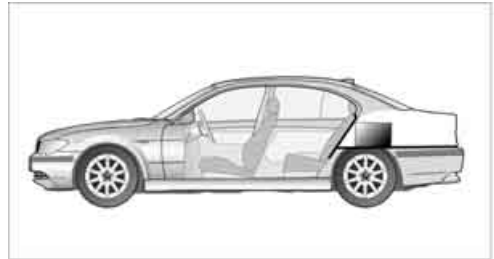

- ▷ Load heavy cargo as far forward and as low as possible, placing it directly behind the bulkhead behind the rear seats
- ▷ Cover sharp edges and corners
- ▷ For very heavy cargo when the rear seat is not occupied, secure each safety belt in the opposite buckle.

Securing cargo

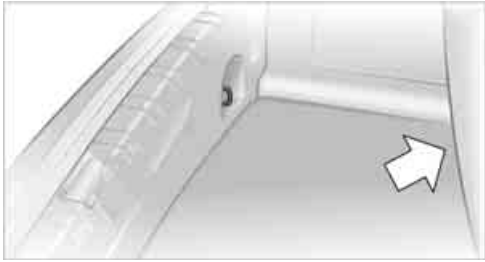

- ▶ Use the luggage net* or securing straps to hold down small and lightweight luggage and cargo, refer to page 42
- ▶ Heavy-duty straps* for securing larger and heavier objects are available at your BMW center. Anchorage for attaching these heavy-duty straps have been provided in your vehicle's luggage compartment, refer to the illustration
- ▶ Please observe the special instructions supplied with the anchorage fittings.

 Always position and secure the load beforehand as described above. If you do not, it can even endanger the passengers during braking or evasive maneuvers.

Never exceed either the approved gross vehicle weight or either of the approved axle loads, refer to page 216, as excessive loads can pose a safety hazard, and may also place you in violation of freeway safety laws.

You should never transport heavy or hard objects unsecured in the passenger compartment, as they could fly around and pose a safety hazard to the vehicle's occupants during abrupt braking or evasive maneuvers. ◀

Roof-mounted luggage rack*

Anchorage points

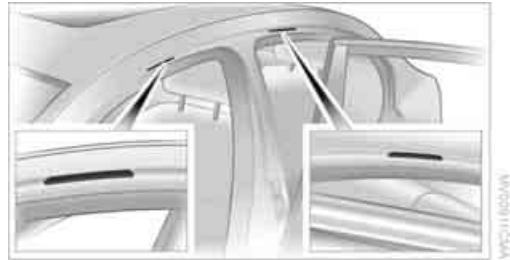

The anchorage points are located within the door openings.

A special rack system is available as an option for your BMW. Please comply with the precautions included with the installation instructions.

Because roof racks raise the vehicle's center of gravity when loaded, they have a major effect on its handling and steering response.

You should therefore always remember not to exceed the approved roof weight, the approved gross vehicle weight or the axle loads when loading the rack.

You can find the specified weights in the Technical data section on page 216.

Make sure that the load is distributed evenly, and that it does not extend outward to beyond the limits of the loading surface. Always load the heaviest pieces first – on the bottom. Be sure that adequate clearance is maintained for raising the glass roof, and that objects do not project into the opening path of the luggage compartment lid.

Secure roof-mounted cargo correctly and securely to prevent it from shifting or being lost during the trip.

Drive smoothly. Avoid sudden acceleration and braking maneuvers. Take corners gently.

Entry/pass tags

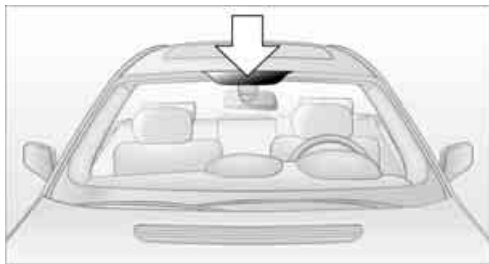

Infrared windshield technology has been used on your vehicle to minimize solar heating of the vehicle interior. This technology also reduces the ability of electronic devices to transmit and receive through the windshield, which will impair their performance and operating range.

If you want to place an electronic toll collection device or entry/pass tags behind the windshield, please use the area marked in the illustration. This area is clearly visible from inside the vehicle.

Standard holder*

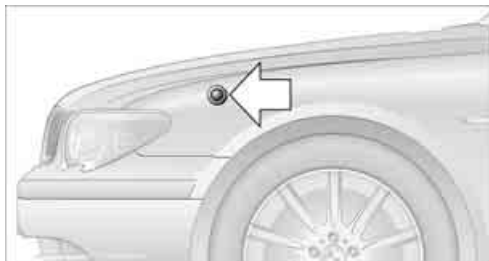

Remove the protective cap, insert the standard and lock in place by turning 90°.

⚠ At high speeds, remove the standard, as otherwise the standard, standard holder and vehicle can be damaged. ◀





Navigation

This section contains various examples that illustrate how the navigation system provides you with reliable guidance to your destination.

Starting navigation system*

GPS

 Enter data only when the vehicle is stationary, and always obey the traffic regulations and road signs in the event of any contradiction between traffic and road conditions and the instructions issued by the navigation system. If you do not observe this precaution, you may be in violation of the law, and can endanger vehicle occupants and other road users. ◀



GPS stands for Global Positioning System. This integral component within your vehicle's navigation system relies on reference satellites to determine the precise position of your vehicle.

By allowing you to find your destination without having to consult conventional road maps as you drive, the navigation system makes an important contribution to traffic safety.

The result: the navigation system provides you with dependable guidance to your destination.

Navigation CD/DVD

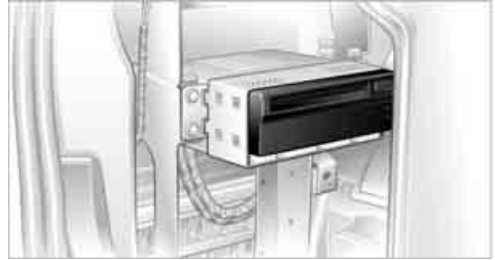

Navigation CDs/DVDs are inserted in the navigation computer located behind the left side trim in the luggage compartment.

You can use navigation CDs as of 2001-1 and navigation DVDs in your navigation computer.

To ensure that your vehicle's navigation system has access to the latest highway network information, always load the most recent CD/DVD version of the digital road map.

As is the case with conventional road maps, the navigation CDs/DVDs are subject to periodic updates to ensure that they reflect the latest information and surveys.

 Navigation CDs/DVDs are available at your BMW center. ◀

Changing navigation CDs/DVDs

As you drive your BMW, the computer will alert you when you are leaving the area stored on your current navigation CD/DVD; you should respond by changing the navigation CD/DVD in the navigation computer.

Navigation CDs contain road maps covering one or more countries or regions.

Roadmaps of Europe are stored on the navigation DVD.

To change the navigation CD/DVD:

1. Press button.



The CD/DVD is ejected from the navigation computer

2. Remove the CD/DVD
3. Insert the new CD/DVD with the labeled side up.

Allow approx. eight seconds for the system to scan the data from the new CD/DVD.

Opening navigation



Select "Navigation".

The last selected view appears on the Control Display. This display will be continually updated as you drive.

When you park the vehicle before reaching the entered destination, upon restarting you will see the question "Continue route guidance?" on the Control Display.

- ▶ When you enter "YES", the destination guidance resumes active operation and the last selected screen content appears on the Control Display
- ▶ When you enter "NO" the Control Display returns to the destination entry mode.

Overview



Press the controller to view the menu items.

- ▶ In the map display mode and during destination guidance, all the menu items will disappear after a few moments if no further entries are made. ◀

Display in assistance window*

You can also view the destination guidance in the assistance window; it then remains visible when you select a new menu.

Select  and confirm your selection. The assistance window displays the view selected on the Control Display. This can be:

- ▶ Map direction north
- ▶ Map in travel direction
- ▶ Map perspective
- ▶ Arrow display.

The contents of the assistance window is continually updated as you drive.

To deactivate display:

Select  again and confirm your selection.

Destination entry

In entering your destination you can select from among the following options:

- ▷ Manual entry of destination address, see below
- ▷ To select town/city and street from the directory, refer to page 134
- ▷ To select destination with map, refer to page 135
- ▷ To select destination with "Information", refer to page 135
- ▷ To select from among recent destinations, refer to page 136
- ▷ To select destination from address book, refer to page 142.

After selecting your destination you can proceed to start the destination guidance, refer to page 139.

⚠ Enter data only when the vehicle is stationary, and always obey the traffic regulations and road signs in the event of any contradiction between traffic and road conditions and the instructions issued by the navigation system. If you do not observe this precaution, you may be in violation of the law, and can endanger vehicle occupants and other road users. ◀

Manual entry of destination address

1. Press the controller
2. Select "Dest. input" and confirm your selection



3. Select "New dest." and confirm your selection.



These menu items offer you various options for entering your destination, as described in the following section.

The system relies on a wordmatch principle to make it easier for you to enter the names or towns or streets. It supports various spellings as well as automatic name completion, refer to page 138.

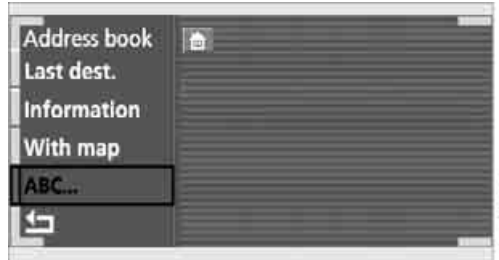

You can enter the address of your destination with "ABC..."



- ▷ "ROUTE GUID." is used to select the entered address as destination and to start destination guidance

- ▶ The "AS ADDRESS" command can be used to store the entered address in the address book.

You can store approx. 50 addresses and then import them directly from your address book to the navigation system as travel destinations, refer to page 142

- ▶ "DELETE" deletes the entered address.

The following features must be borne in mind for destination entry:

- ▶ If you do not enter a street, the system will guide you as far as the city limits
- ▶ Depending on the data stored on your navigation CD/DVD, you can also enter the house or building number on some streets
- ▶ You can skip the entry of country and locality if the current entries are being retained for your new destination
- ▶ You can overwrite street names if you would like to proceed to another street within the same locality.

The example shows how to use the navigation system to find the following destination:

United States
Beverly Hills, Ca
455 N Rexford Drive

To enter the destination address:



Select "ABC..." and confirm your selection.

Entering name

The name is not required for the destination guidance or storage in the list, however can simplify the assignment of addresses.

1. Select "Name" and confirm your selection
2. Turn to select the letters, then confirm your selections by pressing.

Special characters:

-  Cancel selection process
-  Enter blank
-  Delete last letter

3. Select the name shown in the lower half of the Control Display and confirm your selection.



Selecting country of destination

When the name of a country appears in white letters on the Control Display, this indicates that data for more than one country is stored on the navigation CD.

To select the United States as your country of destination:

1. Select "Country" or the country named in the display and confirm your selection. A list of available countries appears in the display
2. Turn until "United States" is selected
3. Press to apply your selection as your destination entry.

Entering destination



"Town/City" or the name of the locality of your last destination will now appear.

1. Select "Town/City" or the displayed town name and confirm your selection
2. Turn until "B" is selected
3. Press to confirm your selection.

A directory listing localities starting with the letter "B" appears in the lower half of the Control Display. The list grows smaller each time you enter a new letter

4. Enter "Beverly Hills" by selecting and confirming the letters individually.

Special characters:

-  Cancel selection process
-  Enter blank
-  Delete last letter

5. Select name of locality from the directory and confirm your selection.



 A town or city must be entered before destination guidance can start. ◀

Entering street, house number and intersection

"Street" or the name of the last street entered will appear.



For instructions on entry, refer to Entering destination.

After entering the street you can proceed to select the house number, for instance: "455".

1. Turn until "4" is selected
2. Press to confirm your selection.

Use the same procedure to select all of the remaining digits in the house number.

Special characters:

-  Cancel selection process
-  Enter blank
-  Delete last character

3. Select the number that appears in the lower half of the Control Display and confirm your selection

 If the selected house number is not stored on the navigation CD/DVD, the system will apply the nearest available number.

The option for entering house numbers will not be offered if no house numbers

are stored for the selected street on your navigation CD/DVD. ◀



4. Address

- ▷ "ROUTE GUID." is used to select the entered address as destination and to start destination guidance
- ▷ The "AS ADDRESS" command can be used to store the entered address in the address book.

The procedure for entering intersections is basically the same as that used for streets.

Selecting town or city and street from directory

If you are uncertain about the precise name of the city or town, or the street, the directory can assist you in entering this information. It can show you all of the stored localities in a given country or of the streets listed for any particular town or city.

The directory appears as soon as you enter the first letter of a locality or street. You obtain a more selective listing the more letters you enter.



Map-guided destination selection

Assume that you only know the general location of your destination's street or locality. You also have the option of selecting the destination on a map using a target cursor and importing it into the destination guidance.

1. Select "With map" and confirm your selection

 In the Control Display, a map section is displayed around the first destination from the destination list, even if the destination guidance system is switched off. ◀

2. Turn the controller to adjust the scale
3. Move the controller in the desired direction to localize your destination. If no further changes are made to the map, after a brief pause the name of the street or locality marked by the cursor will appear on the screen
4. Press the controller to view other menu items:

- ▶  closes "With map"
- ▶ "Next" changes back to "With map"
- ▶ "Location" selects the current position as the map's focus again
- ▶ With "Save dest.", the address in the target cursor can be applied into the destination entry using "ROUTE GUID." or stored in the address book "AS ADDRESS". If the navigation system is unable to identify a street or town/city, your current map coordinates will appear. In order to be able to select this position as destination or to store it in the address book as an address, a name must first be entered, refer to "ABC..."

 You can also use the destination entry map without entering a town or city if you wish to select a destination and import it using the target cursor. ◀



Selecting destination via "Information"

Assume that you are searching for a particular place within a town or city, such as a hotel or restaurant, a filling station, the nearest BMW center, tourist attractions, a hospital.

1. Select "Information" and confirm your selection
2. Select "On location" and confirm your selection

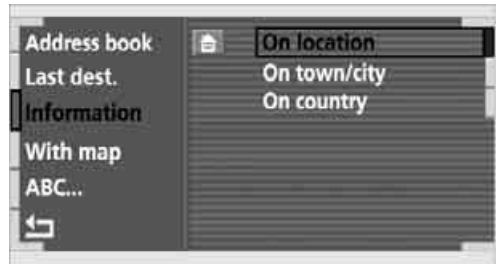

3. Select the desired type of destination, such as "Hotel / Motel" and confirm your selection
4. A maximum of ten destinations now appears on the right side of the Control Display. These are listed by distance to destination, while arrows also appear to indicate their directions from your current position
5. Select and confirm the destination

6. Selecting the address transfers it to the destination list.
 - ▷ Select and confirm your selection to move the display up or down
 - ▷ Select and confirm your selection to exit the view and return to "ABC...".

Using the voice command system:

1. ›Navigation‹
2. ›Information location‹
3. Enter the desired type of destination:
 - ▷ ›Hotels‹
 - ▷ ›Parking‹
 - ▷ ›Gas stations‹.

4. Select your destination category, such as "Airport" and confirm your selection. "ABC..." appears on the Control Display screen along with an alphabetical listing containing all entries in the selected destination category. You can obtain a more selective display of the information contained in the directory by entering one or more letters
5. Select the desired entry.

Using the voice command system:

1. ›Navigation‹
2. ›Information destination‹
3. Enter the desired type of destination:
 - ▷ ›Hotels‹
 - ▷ ›Parking‹
 - ▷ ›Gas stations‹.

Looking for interesting destinations

Are you looking for an interesting destination in a specific locality or country? You can obtain an overview from the navigation CD/DVD which contains listings of interesting destinations in various categories.

1. Select "Information" and confirm your selection
2. Select "On town/city" or "On country" and confirm your selection. A screen for entering the town/city appears on the Control Display



3. Enter the desired town/city or country, select "Next" and confirm your selection

Recent destinations

Returning to a recent destination

The system stores the last ten destinations entered.

Select "Last dest." and confirm your selection.

A list of the stored addresses appears on the right side of the Control Display.

Confirm the desired destination and apply it into the destination entry with "AS DEST.". You can also edit existing entries; for conditions refer to "ABC...".

- ▷ "AS ADDRESS" stores the destination address in the address book
- ▷ "DELETE" removes the destination address.

To delete all current entries:

Select and confirm your selection.

Destination list





This is the most current listing of entered destinations, with the most recent destinations at the top of the list.

▶ Once you have reached the top destination, you are moved on to the next entry in the destination list. ◀

You can edit the entries in this list; start by selecting an entry.



- ▶ Select "CHANGE" and confirm your selection to edit the entries. For operating instructions, refer to "ABC...". In this case, the entries are stored with "AS ADDRESS" in the address book and with "ACCEPT" applied into the destination list
- ▶ Select "DELETE" and confirm your selection to remove the entries
- ▶ Select  and confirm your selection to move the address to the destination list. This can change the order of the destination list.

To delete all current entries:
Select  and confirm your selection.

Route selection

The navigation system also provides you with the option of selecting a specific travel route. You can define criteria for determining your individual route.

1. Select "Route selec." and confirm your selection:

Various options are now listed on the right side of the Control Display



2. Select the priorities for your travel route and confirm your selection:

▶ "With highway"

Freeways and major traffic arteries receive top priority

▶ "Avoid highway"

Freeways are avoided where possible

▶ "Fastest route"

The system determines the fastest route; the selection criteria are distance, vehicle speed and potential sources of traffic congestion

▶ "Shortest route"

Shortest distance without consideration of the time

▶ "Avoid tolls"

The system avoids toll roads whenever possible in selecting the route.

You can change the selected route as often as you like, both when entering your destination and at any time while the system is guiding you to it – the system revises its travel recommendations accordingly.

▶ The navigation system relies on specific rules to determine your route. These vary according to the different kinds of roads stored on the map CD/DVD.

As a result, the routes recommended by the navigation system may not always be the same ones that you would choose based on personal experience. ◀

Using the voice command system:

1. ›Navigation◁
2. ›Route selection◁
3. Enter the desired priority for your travel route:
 - ▷ ›Via freeway◁
 - ▷ ›Without freeway◁
 - ▷ ›Fastest route◁
 - ▷ ›Shortest route◁.

Wordmatch principle

The system relies on a wordmatch principle to make it easier for you to enter the names or towns or streets. The system runs ongoing checks, comparing your destination entries with the data stored on the navigation CD/DVD as the basis for instant response. The user benefits include:

- ▷ When you make an entry that consists of more than one word, the system can identify the name regardless of the sequence in which you enter the individual words.

Example:

Official version:

J.F. Kennedy Square

Possible entries:

Kennedy Square J.F.

or:

Square J.F. Kennedy

- ▷ Names of specific locations can also vary from the official versions provided that the spelling of the entry corresponds to a standard form used in another country
- ▷ When you are entering the names of cities and streets the system will complete them automatically as soon as enough letters are available to ensure unambiguous identification.

Example:

If you want to drive to Iowa Ave NW in Washington, the system has already identified the street name when "o" is entered and displayed it in the lower half of the Control Display

- ▷ The system only accepts name entries beginning with letters that are stored on the navigation CD/DVD. The system will not accept nonexistent names and addresses.

Destination guidance

Starting destination guidance

Select "Route guid." and confirm your selection.



As the navigation computer determines the route to your destination, the distance and the true compass direction to your destination will appear at the upper right of the Control Display – not in all display modes.

Once the system has determined your travel route, the city or town of destination will appear in the upper right corner of the display. The destination guidance is carried out in dependence on the selected view, refer to Displaying route.

The system also provides you with voice instructions.

 You are also guided to your destination if you select another menu, e.g. "Entertainment" or "Climate". You are informed of a required change in direction by means spoken announcements in good time prior to every intersection. ◀

 ›Route guidance on◁.

Displaying route

The "View" menu allows you to view your current travel route at various resolutions.

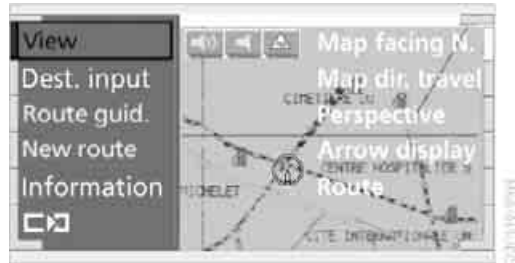

Selecting display of route map

You can also select a map showing your travel route while the system is guiding you to your destination.

1. Select "View" and confirm your selection. All the menu items will disappear after a few moments if no further entries are made
2. Select the view and confirm:
 - ▷ "Map facing N."
A map facing north appears
 - ▷ "Map dir. travel"
A map facing in the direction of travel appears
 - ▷ "Perspective"
A map with the planned route from a 'bird's eye' view appears
 - ▷ "Arrow display"
The destination guidance is by means of arrows on the Control Display and on the Info Display
 - ▷ "Route"
The planned route appears as a list.

 During destination guidance, the route map "North" will appear automatically when you enter an area that is not completely covered by your navigation CD/DVD.

 ›Map◁.
Shows the navigation system map.

Changing scale

Turn the controller to adjust the scale. The map scale is provided at the lower right of the Control Display.

1. >Scale<
2. Enter the desired map scale.

Altering display direction

1. Select "View" and confirm your selection. All the menu items will disappear after a few moments if no further entries are made
2. Select "Map dir. travel" or "Map facing N." and confirm your selection.

Canceling route map

To change to directional arrow mode:

1. Select "View" and confirm your selection. All the menu items will disappear after a few moments if no further entries are made
2. "Arrow display"
The destination guidance is by means of arrows on the Control Display and on the Info Display, refer to page 12.

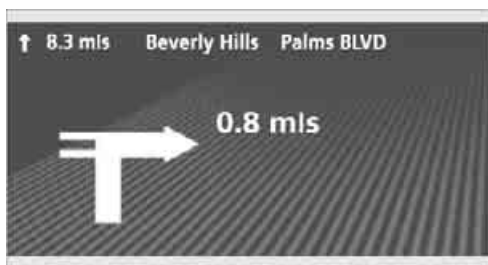

The arrow will follow the general course when you travel through an area for which your navigation CD/DVD does not provide comprehensive coverage. This feature is intended to assist you at crossroads and intersections. ◀

Displaying route list

You can access a listing of streets and towns on your route whenever the destination guidance is active. This list is based on the navigation system's suggested travel route.

The distances remaining to be traveled on each individual road are also displayed.

1. Select "View" and confirm your selection. All the menu items will disappear after a few moments if no further entries are made
2. Select "Route" and confirm your selection.
If the system has not yet completely defined the travel route, "..." will appear in the list.

Select  and confirm to switch off the route list.

The route list is displayed again after a short time if no other menu item has been selected. ◀

Selecting new route

During destination guidance you can revise the navigation system's route recommendations to avoid particular stretches of road. Enter the number of miles/kilometers that you want to travel before returning to the original route.

Select "New route" and confirm your selection.



- ▷ "Avoid sect.":
The route list appears on the Control Display. Select one or several connected sections of the route that you wish to avoid and confirm your selection.
You can correct erroneous entries by again selecting and confirming the stretch of the travel route to cancel its avoid status. You can also replace the avoid section by marking another

stretch.

Select  and confirm; the route list is closed and a new route is calculated

▷ "Avoid route":

You can also make a detour of up to 20 miles/30 km around selected sections of the calculated route. Proceed by turning the controller to enter the desired detour mileage, then confirm your selection. To exit the "Avoid route" mode without modifying your route, enter 0 miles/0 km and confirm your entry.

Bypassing traffic congestion

If traffic congestion is present on your projected travel route, the navigation system will issue a "Last exit" warning just before you reach the back-up.

To obtain an alternative route leading around the traffic congestion:

Select  and confirm your selection or

1. Select "New route" and confirm your selection
2. Select "Detour" and confirm your selection.

The GPS navigation system determines a new route and then returns to the destination guidance.

 The traffic information service might not be available in some regions, which means that a traffic congestion cannot be displayed. ◀

Selecting destination



At "Information", you can select the corresponding destinations. For details, refer to 'Selecting destination via Information', page 135 and 'Looking for interesting destinations', page 136.

Voice instructions

To prevent the navigation system from interrupting other audio sources, such as a news program or traffic bulletin, you can deactivate the voice instructions.

Press the controller and select the desired symbol during destination guidance:

Select  and confirm your selection to switch the voice output on or off.

 ›Message on◀ or
 ›Message off◀.

Select  and confirm your selection to repeat the last direction announcement or the last route instruction when the voice output is switched on.

Volume adjustment

You can adjust the volume for the navigation voice instructions:



Wait until the voice instructions are issued, then turn the button to select the desired volume.

The navigation system's voice instructions will continue to be issued at this volume level, even if the other audio accessories are set to minimum volume.

 The system automatically selects your individual volume setting each time you unlock the vehicle using your personal remote control. ◀

Terminating/interrupting destination guidance

Select "Route guid." and confirm your selection.

The system suspends destination guidance, including voice instructions, until reactivated.

1. ›Navigation
2. ›Route guidance off.

Address book

To make it even easier to enter destinations, the system lets you store addresses for frequent destinations.

You have the possibility to store the addresses in two separate address books:

- ▷ The address book of the navigation system
- ▷ The address book of the voice command system.

Navigation system address book

Storing addresses

In this address book, you can store approx. 50 addresses.

Addresses can be entered from different menus.

The system stores the current address in the address book as "AS ADDRESS".

 You can also enter your current position in the address book after leaving the sector covered by the navigation CD/DVD. In this case, you must enter a name. ◀

Selecting an address

Select "Address book" and confirm your selection.



A list of the stored addresses appears on the right side of the Control Display.

To select an address as destination:

1. Select address and confirm your selection
2. Select "ROUTE GUID." and confirm your selection.

1. ›Navigation
2. ›Destination input navigation
3. Select destination on the Control Display.

You can also edit existing entries in the address book; for conditions refer to "ABC...".

Home address

You can apply your home address into the destination entry.

Select  and confirm your selection.

- ▷ "ROUTE GUID." applies the current home address as destination and destination guidance is started
- ▷ You can enter and edit the home address using the "ABC..." function
- ▷ "LOCATION" applies the current position as home address
- ▷ "AS ADDRESS" stores the entered address or current position as your home address.

Deleting addresses

Select  and confirm to delete all existing entries.

Voice command system address book

Storing addresses

The first destination in the destination list can be stored in this address book:

1. ›Navigation‹
2. ›Save destination‹
3. Enter a name to be assigned to the destination's map coordinates.

It is always the case that only the first entry in the destination list can be saved. To save other addresses, change the destination list accordingly, refer to page 137.

 The house number is not stored in the address book of the voice command system. ◀

Selecting an address

1. ›Navigation‹
 2. ›Destination input with address‹
 3. ›Select destination‹
 4. Enter destination
- or
1. ›Navigation‹
 2. ›Read out address book‹
 - ▶ To scroll forward: ›Next‹
 - ▶ To scroll back: ›Back‹
 - ▶ To repeat: ›Repeat‹
 - ▶ To import to destination list: ›Select‹.

Home address

1. ›Navigation‹
2. ›Route guidance to home‹.

Deleting addresses

To delete individual entries:

1. ›Navigation‹
2. ›Delete‹
3. Select name.

To delete all current entries:

1. ›Navigation‹
2. ›Delete address book‹.

Current position

Display of current position

Select "Location" and confirm your selection.



You can request the current location of your BMW or view a display showing your map position. If the navigation system is unable to identify a town or city, your current map coordinates will appear.

If the navigation system recognizes the city, but not the street and intersection, you can enter these manually, refer to "ABC..." for operating instructions. The entry is applied as the current position with "ACCEPT".

"AS ADDRESS" can be used to import your current position into the address book; you can also enter a name as desired. Entry of a name is mandatory for locations identified only by their map coordinates.

"DELETE" deletes the entry from the address book.

Entering current position

We recommend that you avoid entering subsequent corrections of your position unless absolutely necessary. After transport by truck or rail, etc., the GPS receiver may require several minutes to determine your current position. You can reduce the amount of time the system requires to

determine your current position by entering it manually.

To enter your current position:

1. Select "Location" and confirm your selection
2. The procedure for entering your current position is the same as that used to enter your destination, refer to page [132](#).

 Once effective GPS reception has been established, it will no longer be possible to revise your position manually. ◀

What to do if ...

What to do if ...

- ▶ you request the current position of your vehicle, but do not receive a precise display?
The system is unable to receive enough GPS signals at your current position owing to obstructions, your position is not yet available on your navigation CD/DVD, or the system is in the process of calculating your position. Please wait and then try again later on
- ▶ the GPS logo disappears from the Control Display screen?
Reception is interrupted; a building or similar obstruction may be the cause
- ▶ the destination guidance refuses to import an address from the destination directory as its destination?
The address is not stored on the navigation CD/DVD currently in use. Choose an address as close as possible to the original one, using the destination entry map as required
- ▶ the destination guidance does not apply an address without the street?
No specified center is defined for the selected locality on your navigation CD/DVD. Enter any street, or a destination such as the railway station, etc., then start the destination guidance
- ▶ you want to enter an address for the destination guidance, but it is not possible to select the letters for your desired entry?
The address is not stored on the navigation CD/DVD currently in use. In this case, the system will not offer you any letters to choose from. Choose an address as close as possible to the original one, using the destination entry map as required

- ▶ the system stops furnishing directions on which way to turn as you approach intersections?
You are driving in an area that has not yet been completely recorded on the navigation CD/DVD. Instead of the turn-off arrow, an arrow appears that follows the course of the planned route, or
you have left the proposed route and the system requires a few seconds to calculate a new route proposal
- ▶ during destination guidance the destination route map is automatically displayed?
You are driving in an area that has not yet been recorded on the navigation CD/DVD. The destination guidance cannot operate under these conditions. However, you will see the current position of your BMW in the map display to help you orient yourself
- ▶ the battery has been disconnected?
It will take approx. 15 minutes for the system to resume operation.



The background of the page is a blurred, high-angle photograph of a person's hands playing a piano. The lighting is dramatic, with strong highlights and deep shadows, creating a sense of motion and focus on the instrument.

Entertainment

This chapter is intended to assist you in deriving maximum viewing and listening pleasure from radio and TV broadcasts, CDs or DVDs.

On/off, tone

Controls

Operation using buttons



The illustration shows a CD player as an example.

- 1 Operating audio and video sources
 - ▷ Press: switching on/off
 - ▷ Turn: adjusting volume
- 2 CD slot
- 3 Eject CD
- 4 Change station/track
 - ▷ Change the station
 - ▷ Fast forward/reverse
 - ▷ Music track change for CD, change chapter for DVD changer
 - ▷ Change program for TV

Operation using Control Center

The following control options are available in the "Entertainment" menu.



- ▷ "FM..." and "AM..."
Select waveband

- ▷ "WB"
Select Weather Band
If your vehicle is equipped with satellite radio, "SAT...", select satellite radio, is located at this position
- ▷ "CD" and
Change audio source
- ▷ "Tone"
Set tone, e.g. treble, bass
- ▷ "Video" and "Audio"
Change to video or audio sources



- ▷ "TV" and "DVD"
Change video source
- ▷ "Picture"
Adjust picture
Select standard
Select picture format
- ▷ "Tone"
Set tone, e.g. treble, bass.

You can also control the radio, CD player, CD changer and the TV using the buttons on the steering wheel, refer to page 16, as well as via the voice command system, refer to page 26.

Operating temperatures

The system is configured for operating temperatures of 5 °F / -15 °C to 140 °F / +60 °C. Outside this temperature range, malfunctions can occur. ◀

Care instructions

You can find everything you need to know on this topic by consulting the separate Caring for your vehicle brochure.

Switching on/off



Press the button.

The system returns to the most recently selected audio or video source, radio, CD, DVD or TV.

 ›Radio‹ or ›Audio off‹.

Using with ignition off

Switching the ignition off simultaneously deactivates the sound system.

To switch on again: press the button.

The audio and video functions remain available for use for a period of approx. 20 minutes after you switch off the ignition.

Volume adjustment

Adjusting volume



Turn the button to the desired volume level.

 The sound system automatically reverts to its mute mode automatically whenever you use your portable phone. ◀

 The system automatically selects your individual volume setting each time you unlock the vehicle using your personal remote control. ◀

Tone control

Playing audio recordings

You can choose from the following tone settings:

- ▶ Treble:
To amplify or reduce high frequencies
- ▶ Bass:
To amplify or reduce low frequencies
- ▶ Right/left volume balance, balance:
Left or right, high/low volume
- ▶ Front-to-rear volume balance, fader:
Front or rear, high/low volume
- ▶ Default settings, RESET:
This feature resets the tone settings to their standard default settings
- ▶ Speed-dependent volume adjustment, Speed Volume
- ▶ Spatial sound effect Professional LOGIC7*
- ▶ Equalizer*.

 The speakers and headphones can be adjusted separately. The tone settings of the headphones are made in the rear screen with the headphones connected. Only treble, bass and balance can be adjusted. ◀

 The system automatically selects your individual tone setting each time you unlock the vehicle using your personal remote control. ◀

Tone adjustment

1. Select "Tone" and confirm your selection

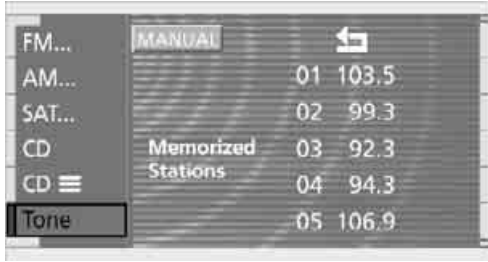

▶ For the tone settings of the TV or DVD, you can directly select "Tone" for the video sources and confirm your selection. ◀

2. Select desired tone settings

- ▶ "Treble" and "Bass"

Select "Treble" or "Bass". Press and turn the controller to make the adjustment



- ▶ "Balance" and "Fader"

Select "Balance" or "Fader". Press and turn the controller to make the adjustment

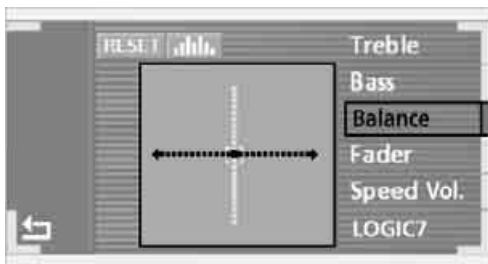

- ▶ "Speed Vol."

Raises volume as vehicle speed

increases. By pressing and turning the controller, you can adjust the values between 1– 6

- ▶ "LOGIC7"*

Select "LOGIC7". Press and turn the controller to make the adjustment.

You can set the spatial sound effect between the values 0 and 10. The best possible spatial sound lies at the values 5 and 6. The best possible spatial sound lies at the values 5 and 6.

At 0, the spatial sound effect is switched off. This setting is suitable for radio plays, for example.

▶ LOGIC7 and the LOGIC7 logo are registered trade marks of Lexicon, Inc., a company of the Harman International Group. ◀



- ▶ Equalizer*

Select  and confirm your selection.

Turn the controller to select the desired frequency range. Repeated pressing and turning of the controller makes the adjustment.

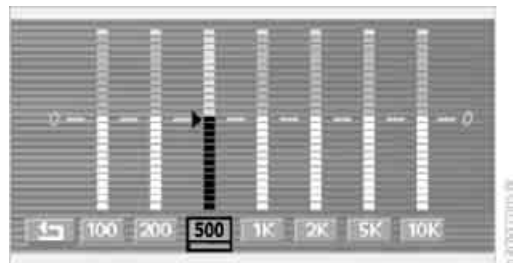

Resetting tone settings

You can reset all tone settings except "Speed Vol." to the standard default settings.

Select "RESET" and confirm your selection.

Radio

Listening to radio

1. Switch on audio or video sources, refer to page 149.
Select "Audio" and confirm your selection if a video source is switched on
2. If another audio source is switched on, select "FM..." or "AM..." and confirm your selection.

 ›Radio<

Volume adjustment, refer to page 149.

Tone control, refer to page 149.

Waveband selection

Your radio provides reception the FM and AM wavebands.

To select waveband:



Select "FM..." or "AM..." and confirm your selection.

Each time you confirm "AM..." the system alternately switches between the AM waveband and the "Autostore" mode.

Each time you confirm "FM...", the system alternately switches between "Memorized Stations" and the "Autostore" mode

 ›FM< or ›AM<

Information display

The current waveband selection appears on the Control Display, for instance, in the FM waveband:

- ▷ Memorized Stations
FM Waveband
- ▷ 03
Number of memory location along with broadcast frequency.

The frequency of the current station can be seen in the lower status line of the Control Display, refer to page 23.

Station selection

You can search for a particular station by selecting its frequency.

1. ›Radio<
2. ›Frequency 88 ..106 (Point 1 ..9)<

Using Control Center

1. Select "FM..." or "AM..." and confirm your selection.

Each time you confirm "AM..." the system alternately switches between the AM waveband and the "Autostore" mode.

Each time you confirm "FM...", the system alternately switches between "Memorized Stations" and the "Autostore" mode

 ›FM< or ›AM<



2. Select "MANUAL" and confirm your selection.

Manual search

1. Select the frequency display and confirm your selection
2. Turn the controller to set the frequency manually
3. Press the controller to confirm your entry.



Next station

◀▶ Select the desired direction and confirm your selection.

The scan mode begins with the currently selected frequency.

The scan mode is stopped as soon as a station is found.

The frequency is shown on the Control Display.

The system switches to the next station.

1. ›Radio‹
2. ›Next station‹ or ›Station back‹.

Listening to sample and selecting, Scan

The automatic scan search feature automatically plays a brief sample from each station in the selected waveband.

1. Select "SCAN" and confirm your selection.
Station search starts
2. To select a station, confirm "SCAN" a second time.
This cancels the scan function, and the radio remains on the current station.

Buttons in center console

Scanning



Extended pressure.

The scan mode begins with the currently selected frequency.

The scan mode is stopped as soon as a station is found.

The frequency of the station appears in the bottom status line, refer to page 23.

Next station



Press to select the desired direction.

The system switches to the next station.

1. ›Radio‹
2. ›Next station‹ or ›Station back‹.

Storing and retrieving a station

Memory locations

Your radio can store 36 stations:

- ▶ You can store as many as 18 stations in the FM waveband
- ▶ You can store up to 18 stations in the AM waveband.

▶ Each time you confirm "AM..." the system alternately switches between the AM waveband and the "Autostore" mode.

Each time you confirm "FM...", the system alternately switches between "Memorized Stations" and the "Autostore" mode.◀

Storing a station

1. Select "FM..." or "AM..." and confirm your selection.

Each time you confirm "AM..." the system alternately switches between the AM waveband and the "Autostore" mode.

Each time you confirm "FM...", the system alternately switches between "Memorized Stations" and the "Autostore" mode

FM< or >AM<.

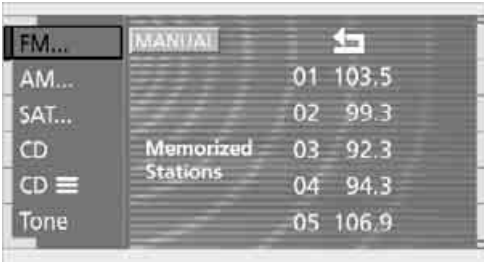

2. Select "MANUAL" and confirm your selection
3. Selecting a station, refer to page 152.
The autostore utility's "AUTOSTORE" feature automatically selects and stores the stations providing the best reception in the AM and FM wavebands
4. Select "MEMORIZE" and confirm your selection. For a manual search, refer to page 153, "MEMORIZE" is selected automatically



5. Turn the controller and select the memory location
6. Maintain pressure on the controller for several seconds.

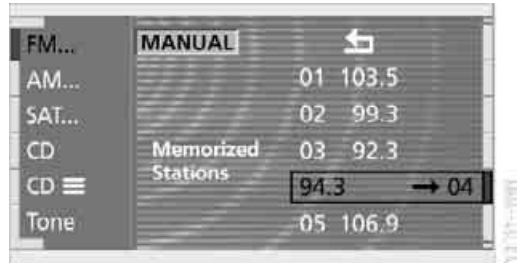

The station is now stored.

Selecting a stored channel

1. Select "FM..." or "AM..." and confirm your selection.

Each time you confirm "AM..." the system alternately switches between the AM waveband and the "Autostore" mode.

Each time you confirm "FM...", the system alternately switches between "Memorized Stations" and the "Autostore" mode

FM< or >AM<.

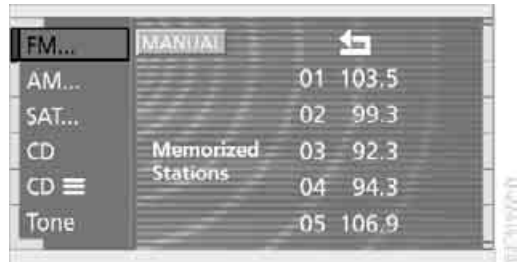

2. Turn and press the controller to select stored stations.

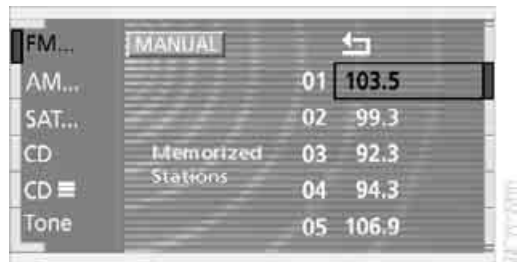

1. >Radio<
2. >Station 1 ..12<.

Weather Band

Weather Radio is a service of the National Oceanic and Atmospheric Administration, NOAA, of the U.S. Department of Commerce. Weather messages are repeated every four to six minutes and are routinely revised every one to three hours, or more frequently if needed. Most of the stations operate 24 hours daily. During severe weather, National Weather Service forecasters can interrupt the routine weather broadcasts and substitute special warning messages. If you have a question concerning NOAA Weather Radio, please contact your nearest National Weather Service Office, or write to National Weather Service, Attn: W/OM11, National Oceanic and Atmospheric Administration, 1325 East-West Highway Silver Spring, MD. 20910.

Selecting Weather Band

1. Select "WB" and confirm your selection
2. Select channels and confirm your selection.

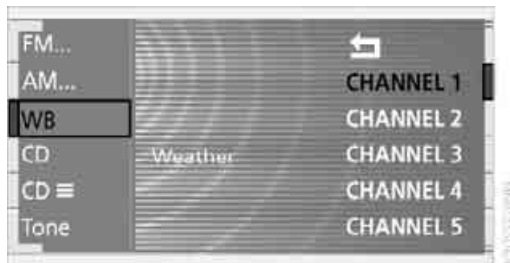

With satellite radio:

1. Select "AM" and confirm your selection
2. Each time you confirm "AM", the system alternately switches between the "AM" and "Weather" mode
3. Select channels and confirm your selection.



 In some regions, only one or two channels can be received or Weather Band channels are unavailable. ◀

Satellite radio*

You can receive approx. 100 different channels with high sound quality.

You can listen to one of these channels free of charge at any time to obtain a first impression. The channel is marked with .

To listen to additional channels of your choice, you must have these channels enabled.

 You may experience signal drops and muting events related to this new technology. ◀

Enabling channels

1. Select "SAT" and confirm your selection.
The channels that can be received are shown in the list
2. Select a channel and confirm your selection



3. Dial the displayed telephone number to have the system enabled.

During enabling, leave the ignition switched on.



Channel selection

1. Select "SAT" and confirm your selection.
Each time you confirm "SAT", the system alternately changes between "Channels", "Category" and the "Pre-sets".
The enabled channels are displayed with ✓



2. Select a channel and confirm your selection

Additional information

3. Confirm channel once again.
The name of the artiste, the title of the track and the name of the album are displayed.



Notes

As a rule, reception is guaranteed under a clear sky. If you are unable to receive any channel, the message "ACQUIRING..." appears in the status line. "Display ESN" shows the electronic serial number on the Control Display. The following also appear:

- ▷ "Call Sirius () to Subscribe", or
- ▷ "Call Sirius () to Activate"

to subscribe or activate the selected channel.



When there is a signal blockage or the transmission is suspended momentarily for more than 4 seconds.

- ▷ Service may be interrupted or unavailable for specific reasons such as environmental or topographic conditions and other factors that satellite radio cannot directly control. The signal might not be available in tunnels, in parking garages, next to tall buildings, near trees with dense foliage, near mountains or other possible strong sources of radio interference. Service should resume normally after the source of signal unavailability has been cleared.◀

Selecting a category

1. Select "SAT" and keep pressing until "Category" appears.
The categories are shown in the category list
2. Select a category, e.g. "POP", and confirm your selection.
All the channels available in the category "POP" are displayed



3. Storing channels and selecting memory locations, refer to next section. Additional information, refer to page 156.

Storing a channel

1. Select "SAT" and confirm your selection
2. Select the desired channel



3. Select "STORE" and confirm your selection. After confirming, you are in the 'preset list'
4. Turn the controller and select a memory location where the channel is to be stored and press the controller for several seconds.



Selecting a stored channel

Turn the controller to select and confirm stored channels in the preset list. Up to twelve stations on which you have previously stored the channels can be selected.

Next station



Press to select the desired direction.

The next channel that appears on the Control Display is selected.

1. ›Radio‹
2. ›Station 1 ..12‹.

CD Compact Disc*

Listening to CDs

Insert the CD in the slot.

If a CD is already inserted in the CD player:

Start playback.



Select "CD" and confirm your selection.

1. \rightarrow CD \leftarrow
2. \rightarrow CD on \leftarrow .

Volume adjustment, refer to page 149.

Tone control, refer to page 149.

Selecting a track using Control Center

Selecting music track

Select music track and confirm your selection.



1. \rightarrow CD \leftarrow
2. \rightarrow Track 1 ..30 \leftarrow .

Listening to sample and selecting, Scan

The system plays a brief sample from each CD track.

1. To start sampling:
Select "SCAN" and confirm your selection
2. To select a track:
Confirm "SCAN" a second time to cancel the scan function. Play resumes at the point on the CD at which sampling was interrupted.

Random play sequence

The music tracks on the CD are played in a random sequence, Random.

To start random play:

Select "RND" and confirm your selection.

To cancel random play:

Select any other function except track search.

 It is possible to hear the same song more than once. ◀

Selecting a track using buttons

Track search

Select the direction.



Press repeatedly, continuing until you reach the desired track.

The CD will start play at the track selected.

1. \rightarrow CD \leftarrow
2. \rightarrow Next \leftarrow or \rightarrow Back \leftarrow .

Fast forward/reverse

1. Select the direction.



Press and hold the button. The tracks can be heard, but the sound is distorted

2. To interrupt the fast forward/reverse function, release the button.
The CD will start play at the point selected.

Malfunctions

 The CD player is a 'Class 1' laser product. Never remove the cover from the housing. Do not operate the unit if the cover is damaged. Operation without the cover can lead to serious eye injury from invisible laser beams.

Always refer all repair and maintenance operations to qualified technicians.

With self-recorded CDs, labels applied later can become detached during playback due to the development of heat, causing irreparable damage to the device. ◀

 To prevent CDs from being copied illegally, they are often provided with copy protection by the manufacturer. Under certain circumstances this can prevent or restrict the playing of CDs on your CD player. In this case please contact the CD dealer or manufacturer. ◀

If you play self-recorded audio CDs, faults, e.g. drop-outs, can occur, or the CD is not played at all.

 High levels of humidity inside the player can condense on the laser's scan lens and prevent it from reading the CD.

Only use round CDs with a standard diameter of 4.7 in/12 cm and do not play CDs with an adapter, e.g. maxi CDs, as otherwise the CDs or the adapter can jam and may no longer be ejected.

Do not use combined CD/DVD, e.g. DVD+, as otherwise the CD/DVD can jam, preventing it from being ejected. ◀

CD changer*

Location

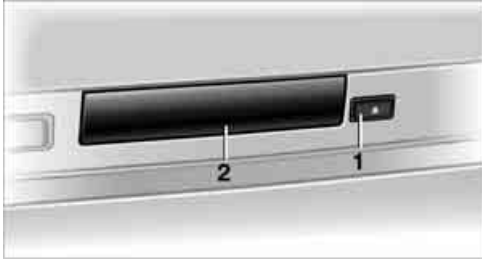

The BMW CD changer with a storage capacity of 6 CDs is installed above the glove compartment.

Removing CD magazine

To insert or remove CDs from the storage magazine you must first remove it from the CD changer:

1. Press button **1**; the lid **2** opens
2. The CD magazine is ejected and can be removed.

Inserting/removing CDs from CD magazine



When inserting or removing CDs always remember to grasp them on the edge, taking care to avoid touching the data side with its mirror finish.

- ▷ To insert:
Insert the CD in its slot with the label side on top
- ▷ To remove:
Pull out the desired drawer and remove

the corresponding CD, as shown in the illustration.

Inserting CD magazine

1. Press button **1**; the lid opens
2. Ensure that the arrow symbol is pointing toward the CD player and slide the magazine **2** all the way in. The lid closes automatically.

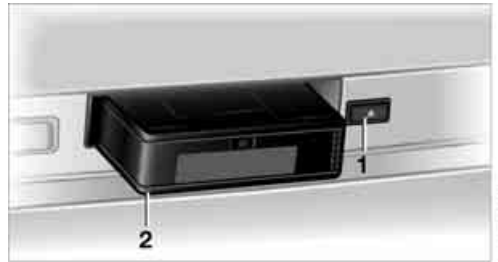

▶ The CD changer automatically reads in the loaded CDs and is then ready for operation. ◀

Listening to CDs

1. Insert the CD magazine
2. Select **CD** and confirm your selection.



After a few seconds, play will resume at the point where the DVD stopped earlier.

If the CD magazine has been newly filled, playback begins with the lowest CD, e.g. CD 1, track 1.

1. **>**CD changer[⌘]
2. **>**CD on[⌘].

Volume adjustment, refer to page 149.

Tone control, refer to page 149.

 If you play self-recorded audio CDs, faults, e.g. drop-outs, can occur, or the CD is not played at all. ◀

Status displays

The CD magazine's load status is indicated on the Control Display.

 If the display fails to detect a CD that you have loaded in the magazine, check to ensure that the CD has been inserted correctly and inspect it for signs of defects. ◀

Selecting a track using Control Center

Selecting a CD

Select CD and confirm your selection.



Playback starts on the first track. At the end of the last track, the next CD will be selected.

1. **>**CD 1 ..6[⌘].

Listening to sample and selecting, Scan

The system automatically plays a brief sample from each of the tracks on the current CD.

1. To start sampling:
Select "SCAN" and confirm your selection.
The Scan function starts with the next track. Once all tracks have been played once, the next track is played
2. To select a track:
Confirm "SCAN" a second time to cancel the scan function. Play resumes at the point on the CD at which sampling was interrupted.

Random play sequence

In this mode the music tracks on the current CD are played in a random sequence, Random.

To start random play:
Select "RND" and confirm your selection.

To cancel random play:
Select any other function except track search.

Selecting a track using buttons

Track search

Select the direction.



Press repeatedly, continuing until you reach the desired track on the current CD. The CD will start play at the track selected.

1. **>**CD changer[⌘]
2. **>**Next[⌘] or **>**Back[⌘].

Fast forward/reverse

1. Select the direction.



Press and hold the button. The tracks can be heard, but the sound is distorted

2. To interrupt the fast forward/reverse function, release the button.
The system will continue play at the point on the CD at which the button was released.

Selecting music track



1. ›CD changer‹
2. ›Track 1 ..30‹.

Malfunctions



The BMW CD changer is a 'Class 1' laser product. Never remove the cover from the housing. Do not operate the unit if the cover is damaged. Operation without the cover can lead to serious eye injury from invisible laser beams.

Always refer all repair and maintenance operations to qualified technicians. With self-recorded CDs, labels applied later can become detached during playback due to the development of heat, causing irreparable damage to the device. ◀



To prevent CDs from being copied illegally, they are often provided with copy protection by the manufacturer. Under certain circumstances, this can prevent or restrict the playing of CDs on your CD changer. In this case please contact the CD dealer or manufacturer. ◀

If you play self-recorded audio CDs, faults, e.g. drop-outs, can occur, or the CD is not played at all.



High levels of humidity inside the player can condense on the laser's scan lens and temporarily prevent it from reading the CD.

Do not use combined CD/DVD, e.g. DVD+, as otherwise the CD/DVD can jam, preventing it from being ejected. ◀

For your own safety, the TV picture is only shown on the rear screen.

 The system is designed for reception of analog television. Due to the quality of mobile reception, reduced picture quality can result depending on the current position and network coverage in spite of the highly advanced reception technology used. A change in vehicle locations can result in improved reception quality in many cases. ◀

Television

1. Switch on audio or video sources, refer to page 149.

Select "Video" and confirm your selection if an audio source is switched on

2. Select "TV" and confirm your selection.

The device selects the last program set.

 ›TV on◀.



Volume adjustment, refer to page 149.

Tone control, refer to page 149.

 All menu items will disappear from the screen after a brief pause if you do not make any additional entries. ◀

Storing programs

The programs with the strongest reception are automatically stored and continuously adjusted to the respective reception situation.

Selecting programs

Using Control Center

1. Press the controller to view the programs
2. Select program and confirm your selection.

Button in rear

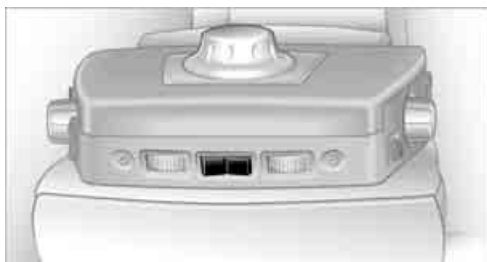

Press the button in the desired direction the number of times required to reach the program you want.

1. ›TV◀
2. ›Next◀ or ›Back◀.

Adjusting picture*

 During reception, the menu items are displayed by pressing the controller. ◀

1. Select "TV" and confirm your selection
2. Select "Picture" and confirm your selection.

Additional menu items are displayed on the right side.

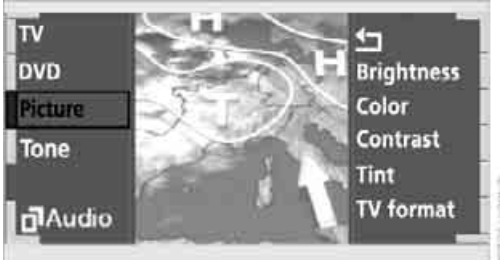

Selecting brightness, color, contrast and tint

Select "Brightness", "Color", "Contrast" or "Tint". Press and turn the controller to make the adjustment.

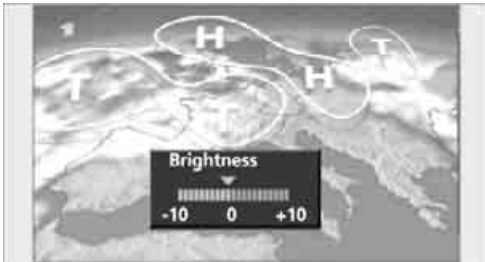

Selecting standard

Television programs can be received worldwide with the multi-standard receiver for PAL, SECAM, NTSC.

The TV standard used is not the same in all countries. However, you can change over your TV receiver to all common TV standards.

 During reception, the menu items are displayed by pressing the controller. ◀

1. Select "TV" and confirm your selection
2. Select "Picture" and confirm your selection
3. Select "TV format" and confirm your selection
4. Select the country you are currently in from the list displayed and confirm your selection.

DVD changer*

Location



The BMW DVD changer for 6 DVDs or audio CDs is mounted behind the left side trim panel in the luggage compartment.

Removing DVD magazine

To insert or remove DVDs or CDs from the storage magazine, you must first remove it from the DVD changer:

1. Push the door to the right, refer to arrow **1**
2. Press the button, refer to arrow **2**.



The magazine is ejected and can be removed.

Inserting/removing CDs/DVDs from DVD magazine



When inserting or removing DVDs/CDs, always remember to grasp them on the edge, taking care to avoid touching the data side with its mirror finish.

- ▶ To insert:
Insert the DVD or CD in its slot with the label side on top
- ▶ To remove:
Pull out the desired drawer and remove the corresponding DVD or CD, as shown in the illustration.

▶ Dual-sided DVDs available from retail suppliers are coated on both sides and bear no markings. This means both sides are information carriers. To play back the information on the other side, remove the magazine and turn over the DVD. If you play self-recorded audio CD-Rs, faults, e.g. drop-outs, can occur. ◀

Inserting DVD magazine

1. Push the door to the right
2. Ensure that the arrow symbol is pointing toward the DVD changer and slide the magazine all the way in



3. Close the door again.

 The DVD changer checks the magazine for inserted DVDs or CDs and is then ready for operation. ◀

DVD country codes

Your DVD changer only plays DVDs with the coding 0 or 1. This coding cannot be changed.

Playing DVDs

 Make all entries with the vehicle stationary. If you do not observe this precaution, you may endanger vehicle occupants and other road users. ◀

1. Insert the DVD magazine
2. Select "DVD" and confirm your selection.



After a few seconds, play will resume at the point where the DVD stopped earlier.

 If the DVD magazine has been newly filled or an audio CD played from the DVD magazine, playback begins with the lowest DVD in the DVD magazine.

 DVD on ◀.

Volume adjustment, refer to page 149.

Tone control, refer to page 149.

Status displays

The DVD magazine's load status is indicated on the Control Display.

 If the display fails to detect a DVD that you have loaded in the magazine, check to ensure that the DVD has been inserted correctly and inspect it for signs of defects.

If there are audio CDs in the DVD magazine, these will not be displayed in the DVD menu, but instead in the CD changer menu. If your vehicle is equipped with an additional CD changer, they will be displayed with the numbers 7 to 12. ◀

DVD control

With the DVD controller you can select the track and chapter, display the DVD-specific menu and operate functions such as Language, Fast Forward and Reverse or Freezing Frame.

A DVD can briefly deactivate functions of the DVD control, under certain circumstances while the entire DVD is being played. You are then unable to operate the DVD control. In this case, attempt to make the selection using the DVD-specific menu.









Display DVD controller:

1. Select "DVD" and confirm your selection
2. Wait briefly until all menu items have disappeared, then press controller.

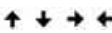

The DVD controller disappears again after a short time if you have not selected a function.

 During playback the DVD controller is displayed by pressing the controller. ◀

| Softkey | Function |
|---|---|
|  | Start playback |
|  | Stop playback |
|  | Close DVD controller |
|  | Activate and deactivate freezing frame |
|  | Searching for chapter |
|  | Fast forward/reverse |
|  | DVD-specific menu: Select functions |
|  | DVD-specific menu: Return to previous menu |

Selecting a track

Several tracks can be stored on a DVD.

1. Select DVD and confirm your selection.
Playback begins after a few seconds
2. Display DVD controller, refer to page 166





3. Select "FULL MENU" and confirm your selection



4. Select "TITLE" and confirm your selection
5. Turn and press the controller to select the desired track.
Playback begins at the track selected.

Fast forward/reverse

1. Display DVD controller, refer to page 166
2. Select the direction

and confirm your selection
3. To increase the fast forward/reverse speed, press the controller several times.
The DVD playback will be distorted
4. End fast forward/reverse:
Select  and confirm your selection.
The DVD will start play at the point selected.

 When the DVD is playing, rapid fast forward/reverse is started by turning the controller. The speed can be increased by turning the controller further. To interrupt the fast forward/reverse function, release the controller. The system will continue play at the point on the DVD at which the controller was released. ◀

Searching for chapter

 You can change to the next or previous chapter during playback. ◀

1. Display DVD controller, refer to page 166

2. Select the direction



and confirm repeatedly, continuing until you reach the desired chapter

or with buttons

select the direction.



Press repeatedly, continuing until you reach the desired chapter on the current DVD.

Playback begins at the chapter selected.

Adjusting picture

1. During playback, press controller

2. Select  and confirm your selection

3. Adjusting the picture, refer to page 164.

Freezing frame

1. Display DVD controller, refer to page 166

2. At the desired point:

Select  and confirm your selection.

The film is stopped

3. To restart the DVD:

Select  or  and confirm your selection.

DVD playback is continued at the point at which it was interrupted.

Selecting picture format

You can adjust the DVD format to your screen.

The picture format is a DVD-specific function and is not offered by all DVDs.

1. Display DVD controller, refer to page 166

2. Select  and confirm your selection

3. Select  and confirm your selection

4. Select "Picture" and confirm your selection

5. Select "Pict. format" and confirm your selection



6. Select the desired picture format and confirm your selection.

Selecting language, subtitles and viewing angle

Many DVDs offer dialogs and subtitles in various languages or scene descriptions for the hearing impaired. In addition, with some DVDs the film can be viewed from different camera angles. These functions are stored on the DVD.

To select functions:

1. Display DVD controller, refer to page 166

2. Select "FULL MENU" and confirm your selection.



- ▶ Select "AUDIO" and confirm your selection.

You can select from the various languages by turning and pressing the controller

- ▶ Select "SUBTITLE" and confirm your selection.

You can display the subtitles in the language of your choice by turning and pressing the controller

- ▶ Select "ANGLE" and confirm your selection.

You can change the camera angle by turning and pressing the controller.

Notes or symbols that appear during the playback of a film generally point out different camera angles. These are usually only briefly available.

- ▶ With some DVDs the language, subtitles or camera angle is only possible with the DVD-specific menu.

Refer to the information on your DVD for possible selections. ◀

Opening DVD-specific menu

Additional functions may be available on DVDs. For example, the viewer can select from several possible plots or display information on the film.

1. Display DVD controller, refer to page 166
2. Select "MENU" or "TOP" and confirm your selection.

- ▶ With "MENU" you can generally open the DVD-specific main menu. On some DVDs you will find an additional menu called "TOP" in which, for example, you can select music scenes. ◀

To make a selection:

1. ↑ ↓ → ← to select a function
2. "OK" to confirm selection.

To return to a previous menu:

Select ◀ or ↶ and confirm your selection.

- ▶ Language, subtitle or angle can also be selected in the DVD-specific menu.

Refer to the information on your DVD for possible selections. ◀

Malfunctions/notes

 The BMW DVD changer is a 'Class 1' laser product. Never remove the cover from the housing. Do not operate the unit if the cover is damaged. Operation without the cover can lead to serious eye injury from invisible laser beams. Always refer all repair and maintenance operations to qualified technicians. With self-recorded CDs or DVDs, labels applied later can become detached during playback due to the development of heat, causing irreparable damage to the device. ◀

 Macrovision copy protection: This product incorporates copyright protection technology that is protected by method claims of certain U.S. patents and other intellectual property rights owned by Macrovision Corporation and other rights owners. Use of this copyright protection technology must be authorized by Macrovision Corporation, and is intended for home and other limited viewing uses only unless otherwise authorized by Macrovision Corporation. Reverse engineering or disassembly is prohibited. ◀

 To prevent CDs from being copied illegally, they are often provided with copy protection by the manufacturer. Under certain circumstances this can prevent or restrict the playing of CDs on the DVD changer. In this case please contact the CD dealer or manufacturer. ◀

If you play self-recorded audio CDs, faults, e.g. drop-outs, can occur, or the CD is not played at all.

The DVD changer can play the following formats:

- ▷ Video DVD
- ▷ CD-DA, Audio CD
- ▷ CD-R.

 The DVD Audio format is not supported by the DVD changer. However, many audio DVDs available in stores also contain a video track in the DVD Video format in addition to the audio track. These DVDs can be played back by the DVD changer. Please refer to the information on your DVD to determine whether your audio DVD contains an additional video track. DVDs are usually divided into tracks and chapters and can contain different subtitles, camera angles or sound tracks, languages and sound formats. Depending on the version of the DVD, these functions can be selected either directly with the DVD control system or only via the DVD-specific menu. Refer to the information on your DVD for possible selections.

High levels of humidity inside the player can condense on the laser's scan lens and prevent it from reading the DVD.

Do not use combined CD/DVD, e.g. DVD+, as otherwise the CD/DVD can jam, preventing it from being ejected. ◀



Communications

This chapter describes the extensive array of options available for mobile communications with family, friends, business associates and service providers.

Using the phone in your vehicle

Safety notice

A car phone can provide many services, in an emergency even initiating a lifesaving rescue. However, bear the following in mind:

Adjustments

 To avoid posing an unnecessary hazard due to inattention, both to your own vehicle's occupants and to other road users: never attempt to use the controls or make entries unless traffic and road conditions allow. ◀

Using the phone in your vehicle

 Using a portable phone to make and receive calls while driving is now illegal in virtually every country in the world. Always use your hands-free system, or stop your vehicle in an area where you will not pose a safety hazard to other road users and switch the engine off. ◀

Antenna

 When using the phone, ensure that all persons in the area are at least 20 in/ 50 cm from the antenna. Never use your BMW portable phone if the antenna is damaged. Contact between your skin and a damaged antenna can result in minor burns.

If the antenna is damaged, have it replaced immediately. ◀

Special environmental conditions

 Do not use your phone within a garage, or near an open hood. The air in these areas could contain fuel vapors, and the portable phone might generate sparks that could result in burns. This same precaution applies to opening luggage compartment lids on vehicles equipped for operation using natural gas or hydrogen, and to all vehicles with luggage compartment-mounted batteries.

Always switch off your BMW portable phone in areas where blasting work is being conducted with explosives. The phone signals could potentially act as a high-frequency transmitter and set off explosions.

Always switch off your BMW portable phone in areas where an increased explosion danger is present. This category includes filling stations along with fuel and chemical storage depots, etc., and all areas in which the air can contain fuel, chemicals or metal particles. Under these conditions, your BMW portable phone could conceivably generate sparks that could lead to a fire or explosion. Always observe all legal regulations governing the use of portable phones in the vicinity of filling stations, chemical factories and other areas where an explosion potential exists.

Never use the BMW portable phone in hospitals, care centers or at other locations where medical equipment may be in operation, such as accident sites, etc.

Your wireless service provider can furnish you with more detailed information on legal regulations governing the use of your phone. ◀

Medical equipment

 Portable phones can generate interference capable of preventing hearing aids and cardiac pacemakers from operating correctly. If you or any occupant of the vehicle use such equipment, consult a physician or the manufacturer of the equipment to determine whether it is adequately shielded against high-frequency energy. Persons with cardiac pacemakers should bear the following in mind:

Always hold the switched-on BMW portable phone more than 6 in/15 cm away from the cardiac pacemaker.

Do not carry the BMW portable phone in your breast pocket.

Use the ear on the opposite side of the cardiac pacemaker to reduce the likelihood of

influencing the cardiac pacemaker. With the slightest sign of a cardiac pacemaker malfunction, switch the BMW portable phone off immediately. ◀

Batteries

 To avoid possible short circuits, after removing a battery you should never allow it to come into contact with metallic surfaces of any kind. This is why you should handle charged batteries with care, in particular if you place batteries, e.g. in jacket or shirt pockets that contain metal objects. If you are in an environment where there is a risk of explosion, do not remove the battery from the device, as otherwise sparks from your battery could cause explosions or fire. ◀

Disposing of used batteries

 Return used batteries to a recycling collection point or to your BMW center. ◀

Care instructions

You can find useful information on caring for your portable phone in the Caring for your vehicle brochure and in the separate portable phone Owner's Manual.

Controls

To be able to use the BMW portable phone via the vehicle equipment, it must be located in the cradle, refer to page 178.

 For information on operating your portable phone, please consult the separate Owner's Manual. ◀

The BMW portable phone can be operated by means of:

- ▶ The steering wheel, refer to page 16
- ▶ The Control Center.
- ▶ The folding telephone keypad
- ▶ The voice command system, except for incoming calls.

Control Center

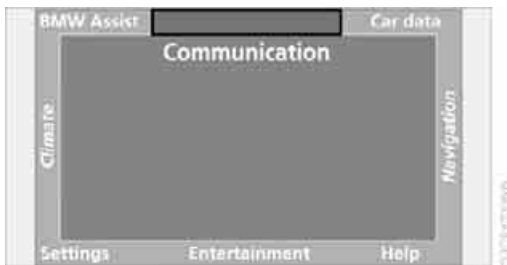

You can use the following functions in the Control Center:



- ▶ The phone book
- ▶ The TOP 8 list
- ▶ The redial list.

After selecting the desired entry, a connection can be set up via:

- ▶ The button on the steering wheel
- ▶ The folding telephone keypad
- ▶ The Control Center.

Here, the dialed number appears in the upper status line, refer to page 23.

Missed calls are also shown in a list if this service is supported by your wireless service provider.



Select  and  and confirm your selection to switch between the two pages of the "Communication" menu.





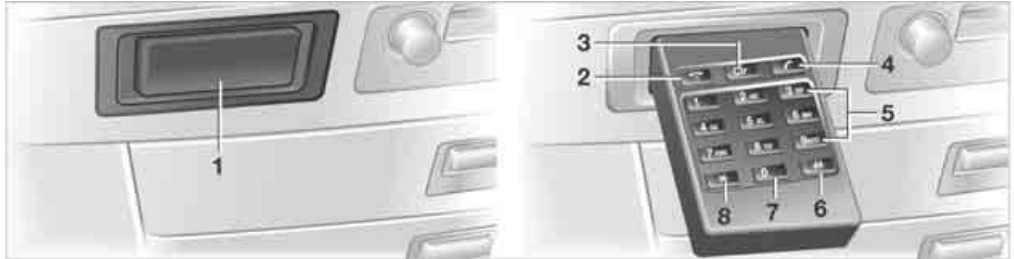

Telephone keypad, folding

The telephone keypad allows you to use all of the basic BMW portable phone functions without ever picking up the handset. Calls are automatically routed through the hands-free system.

 The telephone keypad is available for operation at the radio mode in the ignition lock, refer to page 62. ◀



- 1 Briefly press the telephone keypad, it will extend automatically
When you are done using the telephone keypad, press it back in, continuing until the detent engages
 It is not possible to remove the telephone keypad. ◀
- 2  Press briefly: terminate call
Press longer: switch BMW portable phone on and off
- 3  Press briefly: delete the last character entered
Press longer: delete the entire number

- 4  Press briefly: dial or accept call
- 5  Enter digits 1 – 9

- 6  Enter the special character
- 7  Enter the digit 0
- 8  Press briefly: enter the special character
Press longer: pause for dialing in the touch tone mode

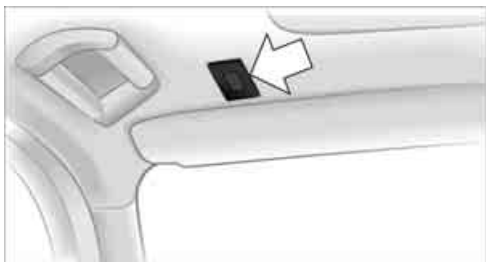
Hands-free system



The hands-free microphone is located on the left-hand side on the headliner.

The hands-free system is activated whenever you establish or receive a call using the following:

- ▶ Buttons on the steering wheel, page 16
- ▶ Voice command system, page 26, except for incoming calls
- ▶ Control Center, page 175
- ▶ Telephone keypad, folding, page 176.

Volume adjustment

You can adjust the volume for the hands-free unit:



Turn this button during a call to select the desired volume.

The hands-free unit will remain at this volume level, even if the other audio sources are set to minimum volume.

 The system automatically selects your individual volume setting each time you unlock the vehicle using your personal remote control. ◀

Starting an emergency call

1. To open the protective cover:
Briefly press the protective cover
2. Press the emergency call button for at least 2 seconds.

The indicator lamp in the button lights up. As soon as the voice connection to the BMW Assist response center has been established, the indicator lamp flashes.



Conditions for an emergency call:

- ▶ Ignition key from radio position
- ▶ The wireless communications network is available
- ▶ The emergency call system is operable.

If the current position of your vehicle can be determined with vehicles with an activated BMW Assist, it will be transmitted to the BMW Assist response center.

 A navigation CD/DVD must be inserted, as otherwise the current vehicle position cannot be determined. If the navigation system is inoperative, the current position of the vehicle is not transmitted. ◀

Following transmission of the data a confirmation report will appear on the Control Display. The response center can initiate immediate action for emergency assistance.

If it is repeatedly not possible to transfer the data, a voice connection to the BMW Assist response center will be established.

 If conditions allow, remain in the vehicle until the connection has been established. You will then be able to pro-

vide a detailed description of the situation. ◀

 For technical reasons, the emergency call cannot be guaranteed under unfavorable conditions. ◀

Under certain conditions, an emergency call is started automatically immediately after a severe accident. The automatic emergency call is not affected by the emergency call button being pressed.

Commissioning BMW portable phone

1. Pull back the cradle slightly
2. Insert the portable phone.

 For portable phones with SIM card: First switch on portable phone and enter PIN, then insert. ◀

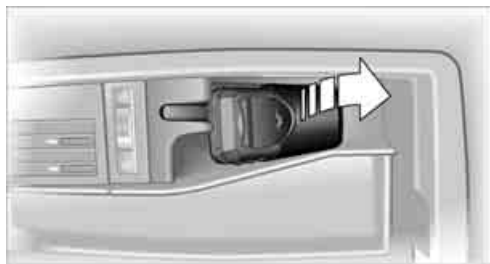

 Before driving, place the BMW portable phone in the cradle. You can then control the portable phone with the button in the steering wheel, the Control Center, the telephone keypad or the voice command system. ◀

Switching your BMW portable phone on and off

 You can switch your BMW portable phone on and off by maintaining extended pressure on the telephone keypad.

Entering lock code

If, after switching on the BMW portable phone, you are requested by a message on the Control Display to enter the lock code:

1. Enter the lock code, e.g. 1234
2. Press the button



Getting started

Making a call

1. Enter the desired phone number
2. Press the button



The phone number appears in the Control Display's status line.

-  1. ›Dial◀
2. Enter the phone number
- ▶ Listen to the entered numerical sequence: ›Read out◀
 - ▶ Delete the entire number: ›Delete◀
3. ›Dial◀

 Always remember to enter the complete telephone number, i.e. the area code, even if you are currently in the same area as the number that you wish to contact. ◀

Ending a call

Press the button



Calls during a call

This function can only be used through the keypad.

Accepting a call

Press the button



Rejecting a call

Press the button



Switching between two calls

Press button again



Ending a call when two connections exist, switching between calls

Press the button



The current connection is terminated. The second call kept on hold can now be continued.

The second calling party's number will be displayed on the Control Display, even after the second call is terminated.

Phone book

You must enter your portable phone's phone book in the voice command system before it will be available for access using the vehicle's voice commands. This creates a special voice-command phone book. If changes are then made to the phone book using the voice command system, these modifications will apply exclusively to the voice-command phone book, and not to the phone book in the portable phone.

Creating and updating voice-command phone book*

1. ›Telephone‹
2. ›Update telephone book‹.

The entries in the portable phone's phone book appear sequentially on the Info Display.

You must assign a specific name to each number that you wish to transfer to the voice-command phone book. These numbers will no longer be requested during updates.

Making a new entry in voice-command phone book

1. ›Save name‹
2. Enter name and repeat entry upon request
3. Enter phone numbers
4. ›Save‹.

Dialing from phone book

1. Select "Communication"
 - ▶ Select "A-Z" and confirm. An alphabetical listing of all the entries in the phone book appears on the right side of the Control Display.
 - ▶ Select "1,2,3" and confirm your selection. A listing of all entries in the phone book appears on the right side of the Control Display



2. Select the desired entry and confirm your selection
3. Select  and confirm your selection.

The connection is established. Here, the dialed number appears in the upper status line, refer to page 23.

The system dials the number.

 The connection can also be established using the button on the steering wheel or the telephone keypad. ◀

-  1. ›Select name◀
2. Enter name.

Select  and confirm to end the call.

Viewing entries

-  ›Read out◀
- ▶ To scroll forward:
›Next◀
 - ▶ To scroll back:
›Previous◀
 - ▶ To repeat entry:
›Repeat◀
 - ▶ To call:
›Dial◀.

Deleting individual entries

-  1. ›Telephone◀
2. ›Delete entry◀
3. Enter name.

Deleting entire phone book

-  1. ›Telephone◀
2. ›Delete telephone book◀.

Selecting a number from Top 8 list

The eight numbers that you call most frequently on the BMW portable phone are automatically stored in the Top 8 list.

 The phone numbers are only stored in the Top 8 list when these phone numbers are stored as an entry in the portable phone. ◀

The number called most often appears at the top of the list.

1. In the "Communication" menu, select "TOP 8" and confirm your selection
2. Select an entry from the list that now appears on the display, and confirm your selection
3. Select  and confirm your selection.

The connection is established. Here, the dialed number appears in the upper status line, refer to page 23.

 The connection can also be set up using the button on the steering wheel or the telephone keypad. ◀

Select  and confirm to end the call.

Redialing

Numbers that you reached on earlier attempts as well as numbers that were unavailable are automatically stored in your redialing list. A total of 8 phone numbers can be stored. The last number dialed is at the top of the list.

1. Select "Communication"
2. Select "Last" and confirm your selection



3. Select an entry from the list that now appears on the display, and confirm your selection
4. Select  and confirm your selection.

The connection is established. Here, the dialed number appears in the upper status line, refer to page 23.

 The connection can also be set up using the button on the steering wheel or the telephone keypad. ◀

You can use the voice command system to redial the last number called:

 Redial.

Select  and confirm to end the call.

Missed calls

If the phone number of the caller was transferred, you can have a list of all missed calls displayed if this service is supported by your wireless service provider.

1. Select "Communication"
2. Select "Missed" and confirm your selection A call in your absence is indicated with a letter icon in the upper status line, refer to page 23



3. Select an entry from the list that now appears on the display, and confirm your selection
4. Select  and confirm your selection. The connection is established. Here, the dialed number appears in the upper status line, refer to page 23.

 The connection can also be set up using the button on the steering wheel or the telephone keypad. ◀

Select  and confirm to end the call.

BMW Assist*

 To avoid posing an unnecessary hazard, both to your own vehicle's occupants and to other road users, only make entries with the vehicle stationary. ◀

Requirements

If the following requirements are met, you can call up BMW Assist:

- ▷ Telephone is connected and switched on
- ▷ The lock code has been entered
- ▷ The mobile communications network is available
- ▷ GPS reception for transmission of the data is ensured.

 The position of the vehicle can influence the mobile communications/GPS reception. As a rule, mobile communications/GPS reception is only possible under a clear sky.

When vehicle data is exchanged with the BMW Service Center, a corresponding message appears on the Control Display. ◀

Roadside Assistance of the BMW Group

Here, you can automatically dial the number of the Roadside Assistance of the BMW Group, your BMW center or BMW Customer Relations.

To contact Roadside Assistance, for example in the event of a breakdown:

1. Select "BMW Assist" and confirm your selection
2. Select "BMW Services" and confirm your selection
3. Select "Roadside Assistance" and confirm your selection.
The current vehicle position is displayed



4. Select "ACTIVATE" and confirm your selection.
The data of your vehicle is transmitted to BMW center.

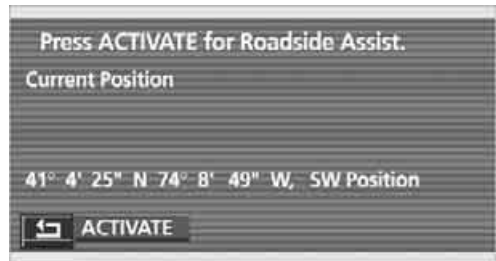

The BMW center forwards the current vehicle position and the customer profile and other vehicle data to the relevant Roadside Assistance service.

To speak to your BMW center or BMW Customer Relations your portable phone must be connected to the cradle in the center console. A voice connection will be established.

 For technical reasons, the emergency call cannot be guaranteed under unfavorable conditions. ◀





Mobility

This section helps you maintain your mobility by supplying important information on vital topics including fuels and lubricants, wheels and tires, service, maintenance and how to deal with any problems that may occur.

Refueling

Fuel filler door



! Always switch off the engine before refueling. If you do not, fuel cannot be filled into the tank and a message will appear in the Check Control. ◀

To open and close: briefly press the rear edge of the fuel filler door.

Manual release

In the event of an electrical defect in the system, you can release the fuel filler door manually:

1. Lift the handle to remove the cover panel on the right side of the luggage compartment
2. Take the button with the fuel pump symbol from the bracket and pull it to unlock the fuel filler door.

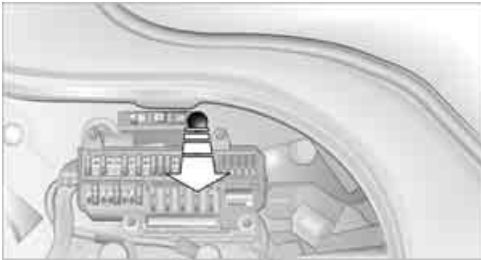

! Always observe all applicable precautions and regulations when handling fuels. Never carry spare fuel containers in your vehicle. Whether empty or full, these containers can leak, cause an explosion, and lead to fire in the event of a collision. ◀

Simple and environmentally friendly

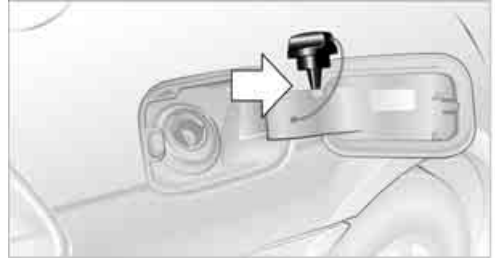

! When handling fuels always observe any safety guidelines posted at the filling station. ◀

Put the filler cap in the bracket attached to the fuel filler door.

When refueling, insert the filler nozzle completely into the filler pipe. Lifting the filler nozzle during refueling

- ▷ results in premature pump shutoff
- ▷ can lead to reduced efficiency in the fuel-vapor recovery system.

The fuel tank is full when the filler nozzle clicks off the first time.

Closing fuel filler cap

! Close the filler cap carefully after refueling, continuing until you hear the detent engage. While closing, be sure not to squeeze the strap which is fastened to the cap. A loose or missing cap will activate a message* in the Check Control. ◀

Fuel tank capacity

Approx. 23.2 US gallons/88 liters, including the reserve capacity of approx. 2.6 gallons/ 10 liters.

! Never attempt to continue driving until the tank is completely empty, as engine functions could be affected, and the vehicle could sustain damage as a result. ◀

Fuel specification

The engine uses lead-free gasoline only.

Required fuel

Premium unleaded gasoline,
minimum octane rating: 91

Minimum octane rating corresponds to the Anti Knock Index AKI and is determined according to the so-called (R+M)/2 method.

 Do not use leaded gasoline, as otherwise the lambda probe and catalytic converter will be permanently damaged. ◀

Use high-quality brands

Field experience has indicated significant differences in fuel quality: volatility, composition, additives, etc., among gasolines offered for sale in the United States and Canada. Fuels containing up to and including 10% ethanol or other oxygenates with up to 2.8% oxygen by weight, that is, 15% MTBE or 3% methanol plus an equivalent amount of co-solvent, will not void the applicable warranties with respect to defects in materials or workmanship.

 The use of poor-quality fuels may result in drivability, starting and stalling problems, especially under certain environmental conditions such as high ambient temperature and high altitude. Should you encounter drivability problems which you suspect could be related to the fuel you are using, we recommend that you respond by switching to a recognized high-quality brand. Failure to comply with these recommendations may result in unscheduled maintenance. ◀

Wheels and tires

Tire inflation pressure

Information for your safety

It is not merely the tire's service life, but also driving comfort and – to a great extent – driving safety that depend on the condition of the tires and the maintenance of the specified tire pressure.

 Check the tire inflation pressure regularly and correct it if necessary, including the spare tire: at least every two weeks and before beginning a longer trip. If you fail to observe this precaution you may be driving on tires with incorrect tire pressures, a condition that can not only compromise your vehicle's stability, but also lead to tire damage and the risk of an accident.

Do not drive with deflated, i.e. flat tires, except run-flat tires. A flat tire will seriously impair your vehicle's handling and braking response. Attempts to drive on a flat tire can lead to loss of control over the vehicle. ◀

Checking inflation pressure

Only check tire inflation pressure when the tires are cold. This means after a maximum of 1.25 miles/2 km driving or when the vehicle has been parked for at least 2 hours. When tires are warm, the tire inflation pressure increases.

After correcting the inflation pressure(s), always reinitialize the Flat Tire Monitor, refer to page 96.

Inflation pressures for standard tires



The inflation pressures for your standard tires can be found on the door pillar when you open the driver's door.

Inflation pressures for other tire sizes

The table below provides all the correct inflation pressures for the specified tire sizes at ambient temperature.

 After correcting the inflation pressure(s), always reinitialize the Flat Tire Monitor, refer to page 96. ◀

Tire size

The inflation pressures apply to the tire sizes approved and tire brands recommended by BMW; a list of these is available from your BMW center.

745i, 745Li

| Tire size | Pressure specifications in psi/kPa | | | | |
|---|------------------------------------|--------|--------|--------|--------|
| <p>All pressure specifications in the table are indicated in psi/kilopascal with cold tires. Cold = ambient temperature</p> | | | | | |
| | 245/50 R 18 100 V M+S | 32/220 | 35/240 | 35/240 | 42/290 |
| | 245/55 R 17 102 W | | | | |
| | 245/50 R 18 100 W | | | | |
| | 245/55 R 17 102 Q M+S | | | | |
| 245/50 R 18 100 Q M+S | | | | | |
| Front: 245/45 R 19 98 W | 32/220 | - | 35/240 | - | |
| Rear: 275/40 R 19 101 W | - | 35/240 | - | 42/290 | |
| Front: 245/40 R 20 95 Y | 32/220 | - | 35/240 | - | |
| Rear: 275/35 R 20 98 Y | - | 35/240 | - | 42/290 | |

More details on the permitted load and weights can be found on page [216](#).

760i, 760Li

| Tire size | Pressure specifications in psi/kPa | | | | |
|---|------------------------------------|--------|--------|--------|--------|
| <p>All pressure specifications in the table are indicated in psi/kilopascal with cold tires. Cold = ambient temperature</p> | | | | | |
| | 245/50 R 18 100 V M+S | 35/240 | 38/260 | 38/260 | 42/290 |
| | 245/50 R 18 100 W | | | | |
| | 245/50 R 18 100 Q M+S | | | | |
| | Front: 245/45 R 19 98 Y | 35/240 | - | 38/260 | - |
| Rear: 275/40 R 19 101 Y | - | 38/260 | - | 42/290 | |
| Front: 245/40 R 20 95 Y | 35/240 | - | 38/260 | - | |
| Rear: 275/35 R 20 98 Y | - | 38/260 | - | 42/290 | |

More details on the permitted load and weights can be found on page [216](#).

Tire identification marks

Knowledge of the labeling on the side of the tire makes it easier to identify and choose the right tires.

Tire size

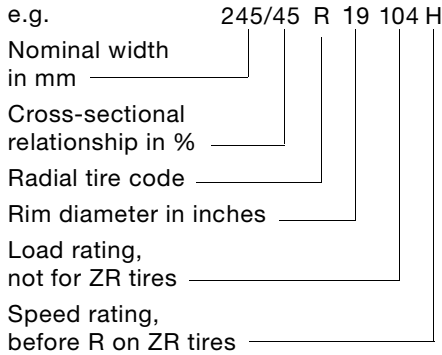

Speed rating

- Q = up to 105 mph/160 km/h
- T = up to 118 mph/190 km/h
- H = up to 131 mph/210 km/h
- V = up to 150 mph/240 km/h
- W = up to 167 mph/270 km/h
- Y = up to 186 mph/300 km/h

Tire Identification Number

Tires with DOT codes meet the guidelines of the U.S. Department of Transport.

DOT code:

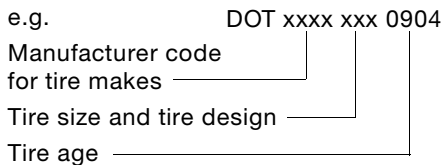

Tire age

The tire's date of manufacture is indicated on the sidewall:

DOT ... 0904 indicates that the tire was manufactured in the 9th week of 2004.

BMW recommends that you replace all tires – including the spare – after a maxi-

imum of 6 years, even though the tires may have a theoretical service life of up to 10 years.

Uniform Tire Quality Grading

Quality grades can be found where applicable on the tire sidewall between tread shoulder and maximum section width.

For example:

Treadwear 200 Traction AA
Temperature A

DOT Quality Grades

Treadwear
Traction AA A B C
Temperature A B C

 All passenger car tires must conform to Federal Safety Requirements in addition to these grades. ◀

Treadwear

The treadwear grade is a comparative rating based on the wear rate of the tire when tested under controlled conditions on a specified government test course.

For example, a tire graded 150 would wear one and one-half, 1½, times as well on the government course as a tire graded 100. The relative performance of tires depends upon the actual conditions of their use, however, and may depart significantly from the norm due to variations in driving habits, service practices and differences in road characteristics and climate.

Traction

The traction grades, from highest to lowest, are AA, A, B, and C.

Those grades represent the tire's ability to stop on wet pavement as measured under controlled conditions on specified government test surfaces of asphalt and concrete. A tire marked C may have poor traction performance.

 The traction grade assigned to this tire is based on straight-ahead braking traction tests, and does not include acceleration, cornering, hydroplaning, or peak traction characteristics. ◀

Temperature

The temperature grades are A, the highest, B and C, representing the tire's resistance to the generation of heat and its ability to dissipate heat when tested under controlled conditions on a specified indoor laboratory test wheel.

Sustained high temperature can cause the material of the tire to degenerate and reduce tire life, and excessive temperature can lead to sudden tire failure. The grade C corresponds to a level of performance which all passenger car tires must meet under the Federal Motor Vehicle Safety Standard No. 109. Grades B and A represent higher levels of performance on the laboratory test wheel than the minimum required by law.

 The temperature grade for this tire is established for a tire that is properly inflated and not overloaded. Excessive speed, underinflation, or excessive loading, either separately or in combination, can cause heat buildup and possible tire failure. ◀

RSC: run-flat tires

You will recognize run-flat tires by a circular symbol containing the letters RSC on the side of the tire, refer to page 192.

M+S

Winter and all-season tires. These have better winter properties than summer tires.

Tire condition

Inspect your tires frequently for treadwear, signs of damage and for foreign objects lodged in the tread. Check the tread depth.

Tire tread

The tread depth should not drop below $\frac{1}{8}$ in/3 mm, although, for example, European legislation only specifies a minimum tread depth of $\frac{1}{16}$ in/1.6 mm. At tread depths below $\frac{1}{8}$ in/3 mm, there is an increased risk of high-speed hydroplaning,

even when only small amounts of water are present on the road surface.

As winter tires display a noticeable loss in their ability to cope with cold-weather driving conditions once the tread wears to below $\frac{1}{6}$ in/4 mm, to ensure continued safety you should always have such tires replaced.

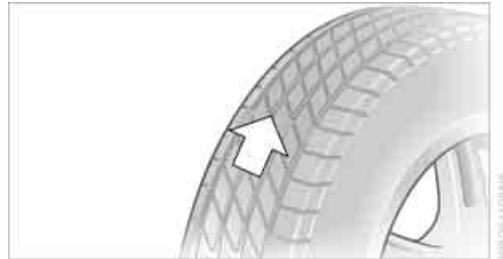

Wear indicators at the tread-groove base, refer to arrow, are distributed over the tire's circumference and are marked on the side of the tire with TWI – Tread Wear Indicator. These indicators signal at a tread depth of $\frac{1}{16}$ in/1.6 mm that the legally permitted wear limit has been reached.

Wheel/tire damage

 Due to low-profile tires, please note that wheels, tires and suspension parts are more susceptible to road hazard and consequential damages. Unusual vibrations encountered during normal vehicle operation can indicate tire failure or some other vehicle defect. This can, for example, be caused by driving over curbs. These kinds of problems may also be signaled by other changes in vehicle response, such as a strong tendency to pull to the left or right.

In these cases reduce speed immediately. Drive carefully to the next BMW center or tire dealer, or have the vehicle towed to one of these locations if necessary.

Tire damage, extending to sudden and complete loss of pressure in extreme cases, can pose a potentially lethal safety hazard for the vehicle's occupants and other road users alike. ◀

Run-flat tires*



You will recognize run-flat tires by a circular symbol containing the letters RSC on the side of the tire.

The run-flat tires consist of self-supporting tires and special rims. The tire reinforcement ensures that the tire retains some residual safety in the event of pressure drop and driving remains possible to a restricted degree.

Continuing driving with a damaged tire

Driving on run-flat tires can continue, depending on the vehicle load and the severity of the tire damage, at a maximum speed of 50 mph/80 km/h.

In the case of complete inflation pressure loss, 0 psi/kPa, or obvious tire damage, you can estimate the possible distance for continued driving on the basis of the following guide values:

- ▷ With low load:
1 to 2 persons without luggage:
Approx. 155 miles/250 km
- ▷ With medium load:
2 persons, luggage compartment full, or
4 persons without luggage:
Approx. 90 miles/150 km
- ▷ With full load:
More than 4 persons, luggage compartment full:
Approx. 30 miles/50 km.

⚠ Drive reservedly and do not exceed a speed of 50 mph/80 km/h. With inflation pressure loss, the driving characteristics change, for example reduced track stability on braking, extended braking dis-

tance, and altered self-steering characteristics.

For safety reasons BMW recommends that you do not have damaged run-flat tires repaired, and that you go to a BMW center in this case. ◀

New wheels and tires

⚠ Only have new wheels and tires mounted by a specialist. If this work is not carried out properly, there is a danger of subsequent damage and related safety hazards. ◀

You can ask your BMW center for the right wheel and tire combination. Have the wheel and tire assemblies balanced every time either a wheel or a tire is replaced.

The correct wheel and tire combination affects various systems whose function would otherwise be impaired, e.g. ABS or DSC.

⚠ BMW does not recommend the use of retread tires, as otherwise driving safety may be reduced. Possible variations in the design and the age – which could be substantial – of the carcasses can lead to unusually rapid wear. ◀

The right wheels and tires

⚠ BMW recommends that you use only wheel and tire combinations that BMW has tested and approved for your particular vehicle. Variations in factors such as manufacturing tolerances mean that even wheels and tires with identical official size ratings could actually have different dimensions than the approved units – these differences could lead to body contact, and with it the risk of severe accidents. If non-approved wheels and tires are used, BMW cannot evaluate their suitability, and therefore cannot be held liable for driving safety. ◀

To maintain good handling and vehicle response, use only tires of a single tread configuration from a single manufacturer. After a flat tire, always remember to have the original wheel and tire combination

remounted on the vehicle as soon as possible.

Recommended tire sizes and brands

BMW tests certain tire brands for each tire size, classifies them as road-safe and approves them. You can find out about these at specialized dealers or at your BMW center. Observe any country-specific regulations, e.g. on making a corresponding entry in the vehicle documents.

The factory-mounted tires have been specially selected to provide optimized performance when installed on your vehicle; if properly cared for, they will provide a combination of safety and excellent ride comfort.

Run-flat tires

If your BMW is equipped with run-flat tires, refer to Run-flat tires, only use these tires, as in the event of a breakdown there is no spare tire available.

Special characteristics of winter tires

BMW recommends winter tires for use in cold winter driving conditions. Although so-called all-season M+S tires provide better winter traction than summer tires, they generally fail to provide the same levels of cold-weather performance as winter tires.

Run-flat tires

When mounting new tires or switching from summer to winter tires, or vice versa, use run-flat tires, as in the event of a breakdown there is no spare wheel available. Your BMW center will be glad to advise you.

Observing speed ratings

 Never exceed the maximum speed for which the winter tires are rated. Unprofessional attempts by laymen to service tires can lead to damage and accidents. Have this work performed by skilled professionals only. The technicians at your BMW center will be glad to assist you with

the required professional knowledge and specialized equipment. ◀

Storage

Always store wheels and tires in a cool, dry place with as little exposure to light as possible. Always protect tires against all contact with oil, grease and fuels. Do not exceed the maximum tire inflation pressure indicated on the side wall of the tire.

Snow chains*

BMW only tests certain snow chains, classifies them as road-safe and approves them. Consult your BMW center for more information. BMW recommends only using these approved, narrow-link snow chains. Use on summer or winter tires is only permissible in pairs on the rear wheels. Observe the manufacturer's instructions when installing snow chains. Do not exceed a vehicle speed of 30 mph/ 50 km/h with the chains mounted.

 After mounting snow chains, do not activate the Flat Tire Monitor. When you are driving with snow chains, it can be beneficial to switch off DSC briefly, refer to page 94. ◀

Under the hood

⚠ Never attempt to perform any service or repair operations on your vehicle without the required, professional technical training. If you are not familiar with the regulations to be observed, only have work on your vehicle carried out by a BMW center or a workshop that uses personnel trained in accordance with BMW requirements. If this work is not carried out properly, there is a danger of subsequent damage and related safety hazards. ◀

Hood

Unlocking



Pull the lever located under the left side of the instrument panel.

Opening



Pull the release handle and open the hood.

Closing



Close the hood from a height of approx. 16 in/40 cm with momentum. It must be clearly heard to engage.

⚠ Observe the same precautions that apply to all closing operations by ensuring that the hood's travel range is clear and unobstructed before allowing the hood to fall into position. If you see any signs that the hood is not completely closed while you are driving your vehicle, you should stop at once and close it securely. ◀

Engine compartment

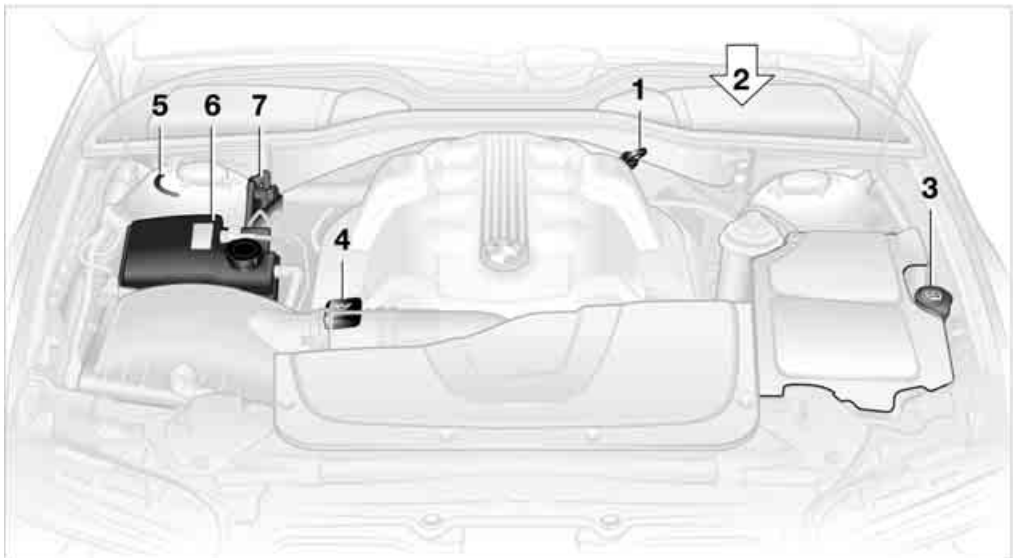

- 1 Engine oil dip stick, refer to Checking oil level
- 2 Brake fluid reservoir, located beneath the microfilter cover [197](#)
- 3 Reservoir for windshield and headlamp washer system [73](#)
- 4 Engine oil filler neck [196](#)
- 5 Vehicle identification number
- 6 Coolant expansion tank [196](#)
- 7 Auxiliary terminal for jump-starting [210](#)

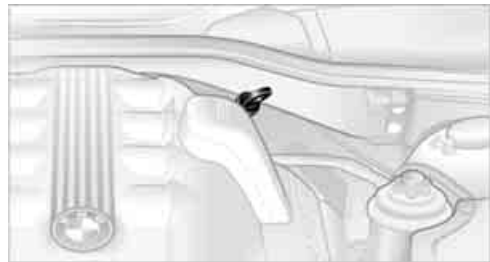

- 5. The oil should extend to between the two marks on the dipstick.

As is the case with fuel economy, the rate at which the engine uses oil is strongly influenced by driving style and operating conditions.

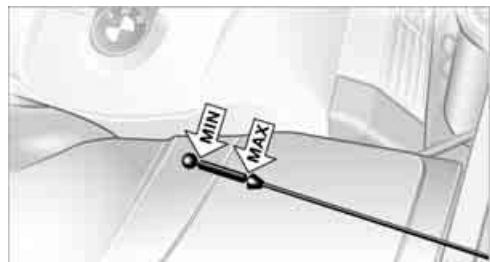

The oil quantity between the two marks of the dipstick is approx. 1.65 US quarts/

Engine oil

Checking oil level

- 1. Park the vehicle on a level surface
- 2. Switch the engine off after it has reached normal operating temperature
- 3. After approx. 5 minutes, pull the dipstick out and wipe it off with a clean lint-free cloth, paper towel, or similar material
- 4. Carefully push the dipstick all the way into the guide tube and pull it out again

1.5 liter. Do not fill beyond the upper mark on the dipstick. Excess oil can damage the engine.

Adding engine oil



Wait until the level has dropped to just above the lower mark or a message appears in the Check Control before adding oil.

! Store oil, grease etc., well out of the reach of children; always observe all warning labels on the containers. ◀

Specified engine oils

The quality of the engine oil selected has critical significance for the operation and service life of an engine. BMW approves only specific oils after confirming their suitability for use in its vehicles with extensive testing.

Use only approved BMW High Performance Synthetic Oil.

If you are unable to obtain BMW High Performance Synthetic Oil, you can add small amounts of another synthetic oil between oil changes. Use only oils with the API SH specification or higher.

▶ Ask your BMW center for details concerning the specific BMW High Performance Synthetic Oil or synthetic oils which have been approved. ◀

You can also call BMW of North America at 1-800-831-1117 or visit this website: www.bmwusa.com to obtain this information.

! BMW engines are designed to operate without additives, and their use could even lead to damage in some cases. ◀

Viscosity ratings

Viscosity is the oil flow rating as defined in SAE classes.

The selection of the correct SAE class depends on the climatic conditions in the area where you typically drive your BMW.

▶ Approved oils are in SAE classes 5W-40 and 5W-30. ◀

These oils may be used for driving in all ambient temperatures.

Coolant

! Do not add coolant to the cooling system when the engine is hot. Escaping coolant can cause burns. ◀

Coolant consists of water and the addition of antifreeze and anticorrosion agent. Not all commercially available additives are suitable for your BMW. Ask your BMW center for suitable additives.

! Only use suitable additives, as otherwise engine damage may result. The additives present a health hazard; observe the instructions on the containers. ◀

♻️ Always observe all applicable rules and regulations for environmental protection when disposing of used anti-freeze and anticorrosion agents. ◀

Checking coolant level

1. The engine must be at ambient temperature
2. Turn the cap of the expansion tank counterclockwise to allow any accumulated pressure to escape, then continue turning to open
3. The coolant level is correct when the coolant extends to between the MIN and MAX marks on the filler neck, refer to the diagram adjacent to the filler neck



assume continued responsibility for the vehicle's operating safety if non-approved pads are installed. ◀

4. If the coolant is low, slowly add coolant up to the specified level – do not overfill.
5. Twist closed the cap and tighten firmly
6. Have the reason for the coolant loss eliminated as soon as possible.

Brake system

Malfunction

Brake fluid



The warning lamp lights up and a message appears in the Check Control: stop immediately.

The brake fluid in the reservoir has fallen to below the minimum level. At the same time, a considerably longer brake pedal travel may be noticeable. Have the system checked immediately.



Warning lamp on Canadian models.



During continued driving increased brake pedal travel may be necessary, and considerably longer braking distances may result. Please adapt your driving style accordingly. ◀

Brake pads

For messages and indicator lamps in the Info Display, refer to page 83.



For your own safety: use only brake pads that BMW has released for your particular vehicle model. As BMW cannot assess the suitability of other brake pads for use on your vehicle, we are unable to

Maintenance

The BMW Maintenance System

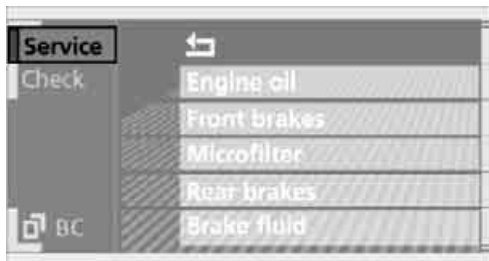

The BMW Maintenance System serves to retain the operating and road safety of your BMW. The service schedule also includes operations related to the vehicle's comfort and convenience features, such as replacement of the filters for the inside air. The aim is to optimize maintenance with regard to reducing the cost of running the vehicle.

Should the day come when you decide to sell your BMW, you will find that a complete dealer service history is an asset of inestimable value.

CBS Condition Based Service

Sensors and special algorithms take the different driving conditions of your BMW into account. As a result, Condition Based Service determines the current and future maintenance requirements. By letting you define a service and maintenance regimen that reflects your own individual requirements, the system forms the basis for trouble-free driving.

The service requirement display, refer to page 82, shows you the times or distances remaining until the deadlines for selected service and maintenance procedures, as well as legally-mandated inspections:

- ▷ Engine oil
- ▷ Brakes, separate for front and rear
- ▷ Microfilter/activated-charcoal filter

- ▷ Brake fluid
- ▷ Spark plugs
- ▷ Vehicle check
- ▷ Coolant
- ▷ Legally prescribed inspections depending on national regulations.

Your vehicle stores this information continuously in the ignition key while the vehicle is being driven. After accessing the data stored in the vehicle key, your BMW service advisor is able to suggest precisely the right array of service procedures for your own individual vehicle. You should therefore hand over to the BMW service advisor the key you last used to drive when you take your vehicle for service.

 Storage periods with the battery disconnected are not taken into account by the CBS maintenance system. Have the time-dependent service and maintenance operations, such as brake fluid and coolant, and if necessary engine oil and the micro/activated charcoal filter, updated by a BMW center. ◀

Service and Warranty Information Booklet for US models and Warranty and Service Guide Booklet for Canadian models

Additional information on required service and maintenance operations is contained in the Service and Warranty Information Booklet for US models and Warranty and Service Guide Booklet for Canadian models.

 BMW recommends having maintenance and repairs carried out by your BMW center.

Make sure that the maintenance operations are confirmed in the Service and Warranty Information Booklet for US models and Warranty and Service Guide Booklet for Canadian models. These entries serve as proof of the regular maintenance performed on your BMW. ◀

Care

You can find useful information on caring for your BMW in the Caring for your vehicle brochure.

Rules and regulations

California laws

Proposition 65 Warning

California laws require us to issue the following warning:

 Engine exhaust and a wide variety of automobile components and parts, including components found in the interior furnishings in a vehicle, contain or emit chemicals known to the State of California to cause cancer and birth defects and reproductive harm. In addition, certain fluids contained in vehicles and certain products of component wear contain or emit chemicals known to the State of California to cause cancer and birth defects or other reproductive harm.

Battery posts, terminals and related accessories contain lead and lead compounds. Wash your hands after handling.

Used engine oil contains chemicals that have caused cancer in laboratory animals. Always protect your skin by washing thoroughly with soap and water. ◀

Event Data Recorders

Your vehicle may be equipped with one or more sensing and diagnostic modules or a recording device capable of recording or transmitting certain vehicle data or information. In addition, if you have a Subscription Service Agreement for the BMW Assist system, certain vehicle information may be transmitted or recorded in order to provide such services.

OBD socket



The Onboard Diagnostic OBD interface socket is located on the left of the driver's side under the instrument panel and under a cover.

The cover has the letters OBD on it.

The purpose of the OBD system is to ensure proper operation of the emission control system for the vehicle's lifetime. The system monitors emission-related components and systems for deterioration and malfunction.



The warning lamp lights up. Worsening of the exhaust emission values. Have the vehicle checked as soon as possible.



Display of the previously described malfunction on Canadian models.



When the fuel filler cap is not properly tightened, the OBD system can detect the vapor leak and the indicator lamp will light up. If the filler cap is subsequently tightened, the indicator lamp should go out within a few days. ◀

Replacing components

Onboard tool kit



The onboard tool kit is located in the luggage compartment lid.

Loosen the wingnut to open.

The adapter for the spare key can be stored beneath the open-ended spanners.

Windshield wiper blades

To replace the blades, start by folding the wipers out and away from the windshield, refer to page 73.

Lamps and bulbs

The lamps and bulbs are essential factors contributing to the safety of your vehicle. Therefore, comply fully with the following instructions during bulb replacement. If you are not familiar with the specified procedures, BMW recommends having the replacements carried out at your BMW center.

Never touch the glass of new bulbs with your bare fingers, as even minute amounts of contamination will burn into the bulb's surface and reduce its service life. Use a clean cloth, napkin, etc., or hold the bulb by its metal socket. ◀

You can obtain a selection of replacement bulbs at your BMW center.

⚠ To prevent short circuits, before working on any electrical system, equipment or accessory you should always switch it off and disconnect the cable from the battery's negative terminal before starting.

To avoid possible injury or equipment damage when changing bulbs, observe any instructions provided by the bulb manufacturer. ◀

▷ When maintaining the headlamps, please comply with the instructions in the separate Caring for your vehicle brochure. ◀

Headlamps

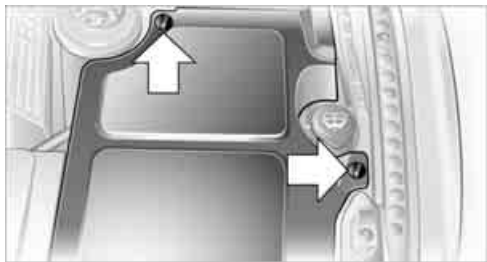

▷ For checking and adjusting headlamp aim, please contact your BMW center. ◀

Engine compartment, left side:
Turn the quick-release snaps 90° counter-clockwise and remove the cover.

After replacing the bulb return the cover to its original position and press the quick-release clamps down.

Releasing lamp cover

The illustration shows the left side of the engine compartment.



1 High beams

Press the tab down, refer to arrow.

⚠ Always wear gloves and eye protection – the atmosphere within the bulb is pressurized. Failure to observe this precaution can lead to personal injury should the bulb be damaged. ◀

1 High beams

H7 bulb, 55 watts

1. Remove the cover
2. Turn the bulb holder to the left and remove
3. Remove and replace the bulb.

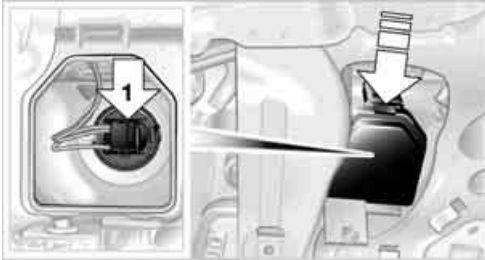

Xenon lamps

The service life of these bulbs is very long and the probability of a failure is very low, provided that they are not switched on and off an unusual number of times. In the unlikely event that one of these lamps should fail, you can respond by switching on your fog lamps and proceeding carefully, where allowed by law.

⚠ Only have work on the xenon lighting system including bulb changes carried out by a BMW center or a workshop that uses personnel trained in accordance with BMW requirements. Due to the high voltage involved, there is a danger to life and limb when work is carried out improperly. ◀

Parking and standing lamps

In the event of a malfunction, please contact your BMW center.

Turn signals, front

Two bulbs, 3457AK or 3457NAK*

1. Turn the bulb holder to the left and remove
2. Apply gentle pressure to the bulb while turning it to the left for removal and replacement.

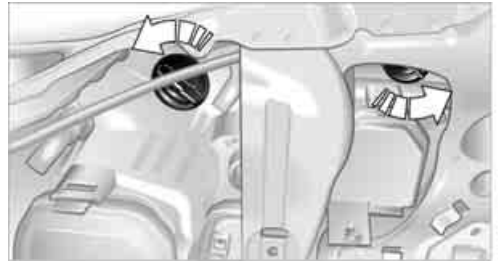

Side-mounted turn signals

Bulb 5 watts, W 5 W

1. Press against the front edge of the lamp with the tip of your finger, then push it to the rear and release the detent at the front
2. Turn the lamp 90° and remove
3. Turn the bulb holder to the left and remove
4. Extract the bulb for replacement.

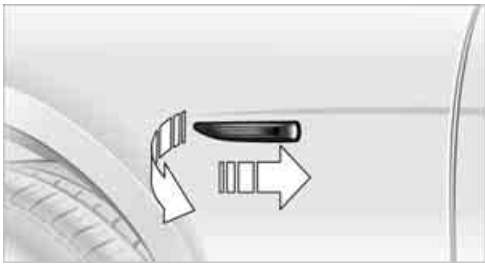

Side marker lamps, front and rear

Please contact your BMW center for replacement.

Tail lamps

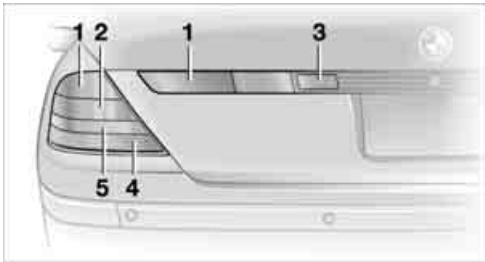

- 1 Rear lamp
- 2 Brake lamp
- 3 Backup lamp
- 4 Turn signals
- 5 Reflector

 The parking, tail and brake lamps are LEDs. If a defect occurs, please contact your BMW center or a workshop that uses personnel trained in accordance with BMW requirements. ◀

Fender-mounted lamps

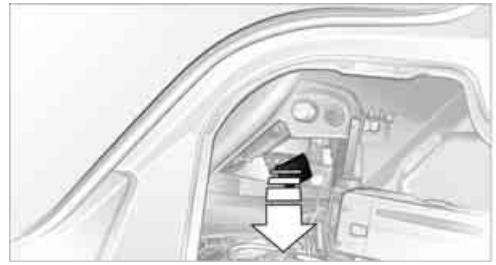

The illustration shows the recess on the left side of the luggage compartment.

Rear turn signals

Bulb 21 watts, P 21 W or PY 21 W*

1. Use the handle at the top to swivel down the side trim panel
2. Turn the bulb holder to the left and remove
3. Apply gentle pressure to the bulb while turning it to the left for removal and replacement.

Lamps in luggage compartment lid



Remove the trim panel from the luggage compartment lid.

- 1 Backup lamp
- 2 License plate lamp

Backup lamps and license plate lamps

Backup lamp: bulb 16 watts, W 16 W

License plate lamp: Bulb 5 watts, W 5 W

1. Pull the bulb holder out
2. Extract the bulb for replacement.

Light-emitting diodes LEDs

Light-emitting diodes installed behind translucent lenses serve as the light source for many of the controls and displays in your vehicle. These light-emitting diodes, which operate using a concept similar to that applied in conventional lasers, are officially designated as Class 1 light-emitting diodes.

⚠ Do not remove the covers, and never stare into the unfiltered light for several hours, as irritation of the iris could result. ◀

Changing wheels

⚠ Safety precautions to observe in the event of a flat and during all tire changes:

Park the vehicle as far as possible from passing traffic. Park on a firm, flat, surface. Switch on the hazard warning flashers. Engage the parking brake and move the transmission's selector lever to P. Have all vehicle occupants get out of the vehicle and ensure that they remain outside the immediate area in a safe place, such as behind a guardrail.

If a warning triangle or portable hazard warning lamp is required, set it up on the roadside at an appropriate distance from the rear of the vehicle. Comply with all safety guidelines and regulations. Change the wheel only on a level, firm surface which is not slippery. The vehicle or the jack could slip to the side if you attempt to raise the vehicle on a soft or slippery surface such as snow, ice, tiles, etc. Position the jack on a firm support surface. Do not use a wooden block or similar object as a support base for the jack, as this would prevent it from extending to its full support height and reduce its load-carrying capacity.

To avoid serious or fatal injury: never lie under the vehicle, and never start the engine while it is supported by the jack. ◀

What you will need

To avoid rattling noises, note the positions of the tools before removing them, then return them to their initial positions after completing work.

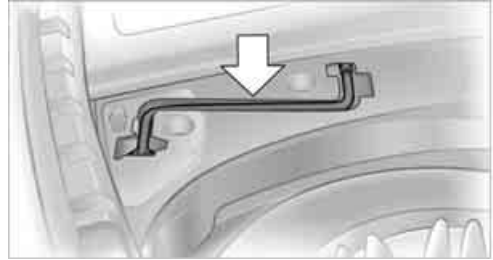

- ▷ Lug wrench
Located beside the spare tire



- ▷ Wheel chock
The chock is located next to the spare tire, or behind the trim panel on the left side of the luggage compartment on vehicles equipped with a trailer coupling.
Remove the floor mat and the cover above the spare tire.
Unscrew the wingnut and remove the wheel chock

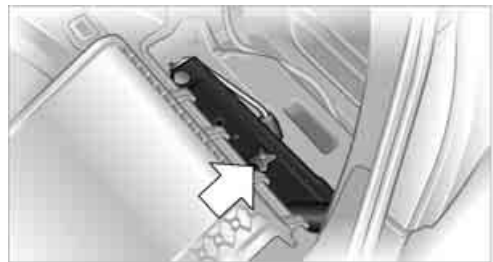

- ▷ Vehicle jack
Located in the luggage compartment behind the right-hand side panel.

Grasp the handle in the upper panel and fold it down. Undo the wingnut and remove the jack. After use, screw the jack all the way back down and snap the handle back into place.

Spare tire

1. Unscrew the wing nut **1**
2. Remove the disc **2** to the side
3. Completely unscrew the threaded rod **3**



4. Remove the spare tire.

Preparing wheel change

1. Read carefully and comply with the safety precautions on page 204
2. Secure the vehicle to prevent it from rolling:
Place the wheel chock against the rear surface of the front tire on the side opposite the side being raised. If the vehicle is parked on a downward slope, place the wheel chock securely in front of the tire. On a steep grade, also secure the vehicle against rolling
3. Loosen the lug bolts 1/2 a turn.

Lifting vehicle

1. Position the jack at the jacking point close to the wheel so that the entire jack base makes contact vertically under the jacking point
 The vehicle jack is designed for changing wheels only. Do not attempt to raise another vehicle model with it or to raise any load of any kind. To do so could cause accidents and personal injury. ◀

2. Guide the jack head into the rectangular recess of the jacking point when cranking up the jack, refer to section of illustration



3. Jack the vehicle up until the wheel you are changing is raised from the ground.

Mounting a wheel

1. Unscrew the lug bolts and remove the wheel
2. Remove accumulations of mud or dirt from the mounting surfaces of the wheel and hub. Clean the lug bolts
3. Position the wheel or spare tire on the hub and screw in at least two bolts diagonally.
When you mount wheels other than Genuine BMW light-alloy wheels, different lug bolts may also be required
4. Screw in the remaining lug bolts. Tighten all the bolts securely in a diagonal pattern
5. Lower the vehicle and remove the jack from beneath the vehicle.

Following installation

1. Tighten the lug bolts in a diagonal pattern
 To ensure safety, always have the lug bolts checked with a calibrated torque wrench as soon as possible to ensure that they are tightened to the specified torque. The tightening torque is 140 Nm. ◀
2. Reverse the removal sequence when storing the wheel and tools in the vehicle

3. Check and correct the tire inflation pressure at the earliest opportunity
 - ▶ Protect valve stems and valve stem seal caps against dirt and contamination. Dirt in valve stems is a frequent source of gradual air loss. ◀
4. Reinitialize the Flat Tire Monitor, refer to page 96
5. Replace the damaged tire with a new one as soon as possible and have the new wheel balanced.

Driving with spare tire

▶ On certain wheel-tire combinations, the size of the spare tire deviates from that of the rest of the tires. The spare tire is fully capable of running in all load and speed ranges. However, to recreate the original conditions, the tire should be replaced as soon as possible. ◀

Run-flat tires*



You will recognize run-flat tires by a circular symbol containing the letters RSC on the side of the tire. They consist of self-contained tires and special rims. The tire reinforcement ensures that the tire retains some residual safety in the event of pressure drop and driving remains possible to a restricted degree. The vehicle is equipped with a Flat Tire Monitor which indicates punctures.

▶ The reinforcement on the flanks of the tires means that it is usually not possible to detect an air loss from outside. ◀

Flat tire

If you have a flat tire, the indicator lamp symbol in the Check Control will light up in red, and a message will appear. In addition, a gong sounds.

You can find more detailed information on the Flat Tire Monitor on page 96.

Reduce vehicle speed carefully to under 50 mph/80 km/h, avoiding hard brake applications and steering maneuvers.

If the defective wheel is not recognizable as such immediately, check the inflation pressure in all four tires.

⚠ For reasons of safety, do not arrange for run-flat tires to be repaired. Your BMW center has the information needed for working with these tires and is equipped with the necessary special tools. ◀

Continuing driving with a damaged tire

Driving on run-flat tires can continue depending on the vehicle load and the severity of the tire damage, at a maximum speed of 50 mph/80 km/h. You can determine the possible mileage for continued driving on the basis of the following general indications:

- ▶ Tire inflation pressure 0 psi/kPa:
With empty vehicle approx. 90 miles/150 km
With full payload approx. 30 miles/50 km
- ▶ Tire inflation pressure 7 psi/50 kPa to 15 psi/100 kPa:
Approx. 300 miles/500 km
- ▶ Tire inflation pressure greater than 15 psi/100 kPa:
Approx. 600 miles/1,000 km.

⚠ Drive reservedly and do not exceed a speed of 50 mph/80 km/h. In the case of air loss, you can expect changes in vehicle handling such as reduce lane stability, longer braking distances, and changes in self-steering properties. ◀

Battery

Battery care

The battery is 100% maintenance-free, i.e., the electrolyte will last for the life of the battery when the vehicle is operated in a temperate climate. Your BMW center will be happy to advise you on all questions concerning the battery.

Charging battery

Only charge the battery in the vehicle via the terminals in the engine compartment with the engine off. Connections, refer to Jump-starting on page 210.

Battery switch

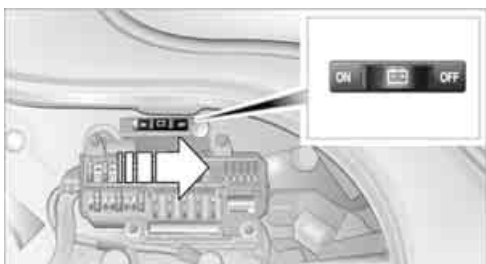

Before storing the vehicle for an extended period of several weeks or more, slide the battery switch located behind the trim panel on the right side of the luggage compartment to OFF. This reduces the current flow from the battery for the period during which the vehicle remains parked. A message appears in the Check Control. Please take note of the supplementary information provided on the Control Display.

Disposal

 Have old batteries disposed of following replacement at your BMW center or bring them to a collection point. Maintain the battery in an upright position for transport and storage. Always secure the battery to prevent it from tipping over during transport. ◀

Power failure

Following a temporary power failure, e.g. in the case of a flat battery, some equipment is subject to restricted use and must be reinitialized. Individual settings are also lost and must be updated again:

- ▷ Seat, mirror and steering wheel memory
The positions must be stored again, refer to page 55
- ▷ Time and date
Must be updated again, refer to page 90
- ▷ Radio
Stations must be stored again, refer to page 154
- ▷ Navigation system
The operability must be waited for, refer to page 130.

Fuses

 Never attempt to repair a blown fuse, and do not replace a defective fuse with a substitute of another color or amperage rating, as this could lead to a circuit overload, ultimately resulting in a fire in the vehicle. ◀

Spare fuses are located on the fuse strip in the glove compartment; plastic tweezers can be found at the fuse holder in the luggage compartment.

In glove compartment



Press the tab on the cover to the front, then fold up the cover.

In luggage compartment

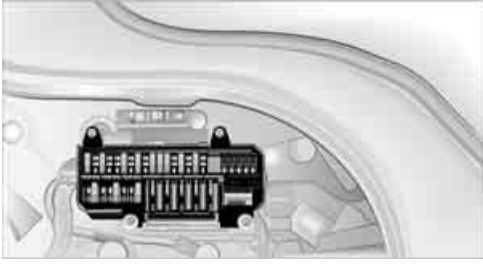

Use the handle to pull down the trim on the right wall.

Giving and receiving assistance

Warning triangle*



The warning triangle is conveniently stored in the onboard tool kit mounted on the inside of the luggage compartment lid.

 Comply with legal requirements requiring you to carry a hazard warning triangle in the vehicle. ◀

First-aid kit*

You will also find the first-aid kit in the onboard tool kit's container.

 Some of the articles contained in the first-aid kit have a limited service life. Therefore, check the expiration dates of the contents regularly and replace the contents concerned in good time if necessary. You can find replacements in any pharmacy. Comply with legal requirements requiring you to carry a first-aid kit in the vehicle. ◀

Jump-starting

When your battery is discharged you can use two jumper cables to start your vehicle with power from the battery in a second vehicle. You can also use the same method to help start another vehicle. Use only jumper cables with fully-insulated terminal clamps.

 To avoid the risk of potentially fatal injury, always avoid all contact with electrical components while the engine is

running. Carefully adhere to the following sequence, both to prevent damage to one or both vehicles, and to guard against possible personal injury. ◀

Preparing

1. Check whether the battery of the other vehicle has a voltage of 12 Volts and approximately the same capacitance in Ah. This information can be found on the battery
2. Switch off the engine of the support vehicle
3. Switch off any electrical systems and components in both vehicles.

 Ensure that no contact exists between the bodywork on the two vehicles, otherwise there is a danger of short circuits. ◀

Connecting jumper cables

 To avoid personal injury from sparks, always observe this sequence when connecting jumper cables. ◀

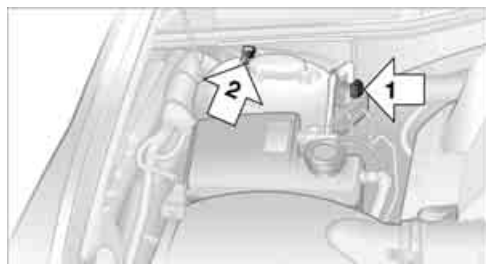

Your BMW is equipped with an auxiliary terminal specifically designed for jump-starting. It is located within the engine compartment, refer to arrow 1 in the illustration. The symbol + is embossed on the cover.

1. Remove the cover of the BMW auxiliary terminal for jump-starting
2. Connect one terminal clamp of the positive/+ jumper cable to the positive terminal of the battery or an auxiliary termi-

nal for jump-starting of the vehicle providing starting assistance

3. Connect the second terminal clamp of the positive/+ jumper cable to the positive terminal of the battery or to an auxiliary terminal for jump-starting of the vehicle to be started

On your BMW, there is a special nut as body ground on the suspension strut dome, refer to arrow **2** in the illustration.

4. Attach one end of the jumper cable minus/- to the negative terminal of the battery or to an engine or body ground of the vehicle providing assistance
5. Connect the second terminal clamp of the negative/- jumper cable to the negative terminal of the battery or to the engine or body ground of the vehicle to be started.

Starting engine

1. Start the engine on the support vehicle and allow it to run for several minutes at a fast idle
2. Start the engine on the other vehicle in the usual way.
If the first start attempt is not successful, wait a few minutes before another attempt in order to allow the discharged battery to recharge
3. Allow the engines to run for several minutes
4. Disconnect the jumper cables by reversing the connection sequence.

If required, have the battery inspected and recharged at your BMW center.

 Never use spray fluids to start the engine. ◀

Towing

Using tow fitting

The threaded tow fitting is stored in the onboard tool kit and must always remain in the vehicle. It can be screwed in at the front or rear of the BMW.

 To avoid damage to the tow fitting and the vehicle, observe the following: only use the tow fitting that comes with the vehicle and screw it in as far as it will go. Only use the tow fitting to tow on roads. Avoid lateral loading of the tow fitting, e.g. do not lift the vehicle by the tow fitting. ◀

Access to screw thread

Press the arrow symbol to push out the cover.

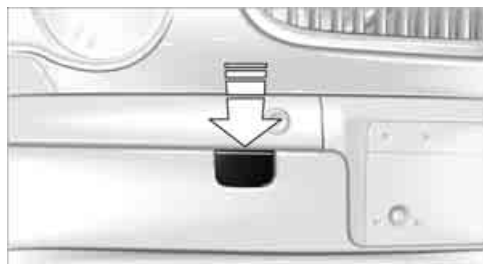

Being towed

 Do not tow the vehicle by the rear axle; because the steering detent is not operational, the wheels could turn to an extreme angle during towing. There is no power assist with the engine stopped. This then requires increased effort for braking and steering. ◀

Switch on the hazard warning flashers depending on the local regulations. If the electrical system fails, mark the vehicle to be towed, e.g. with a sign or warning triangle in the rear window.

! Selector lever in position N. Manual release of the transmission lockout, refer to page 70. Do not exceed a towing speed of 45 mph/70 km/h and a towing distance of 90 miles/150 km, as otherwise the automatic transmission may be damaged. ◀

Towing methods

In some countries, towing with tow bars or ropes in public traffic is not permitted. Familiarize yourself with the regulations on towing in the respective country.

With tow bar

! The towing vehicle may not be lighter than the vehicle to be towed, otherwise it will not be possible to control vehicle response. ◀

The tow fittings used should be on the same side on both vehicles. Should it prove impossible to avoid mounting the tow bar at an offset angle, please observe the following:

- ▷ Clearance and maneuvering capability will be strictly limited in corners
- ▷ When mounted at an angle, the tow bar will exert lateral forces, tending to push the vehicle sideways.

! Secure the tow bar on the tow fitting only. Otherwise damage could result on other vehicle parts. ◀

With tow-rope

When starting off in the towing vehicle, make sure that the tow-rope is taut.

! To avoid jerking and the associated stresses on vehicle components when towing, always use nylon ropes or nylon straps. Secure the tow rope on the tow fitting only. Otherwise damage could result on other vehicle parts. ◀

With tow truck

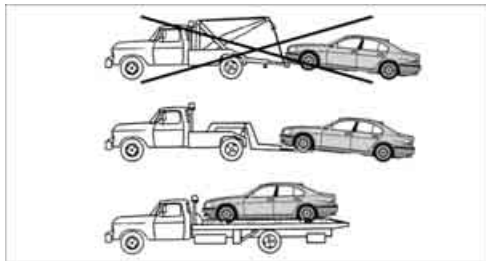

Have the BMW transported with a tow truck with a so-called lift bar or on a load bed.

! Do not lift vehicle by tow fitting or body and chassis parts, as otherwise damage may result. ◀



Reference

This is where to look to find information on any desired topic as quickly as possible.

This chapter includes the section with technical information as well as the manual's index.

Technical data

Engine specifications

| | | 745i, 745Li | 760i/760Li |
|---------------------|-----------------------|-------------|-------------|
| Displacement | cu in/cm ³ | 268.4/4,398 | 364.4/5,972 |
| Number of cylinders | | 8 | 12 |
| Maximum output | hp | 325 | 438 |
| at engine speed | rpm | 6,100 | 6,000 |
| Maximum torque | lb ft/Nm | 330/450 | 444/600 |
| at engine speed | rpm | 3,600 | 3,950 |

Dimensions

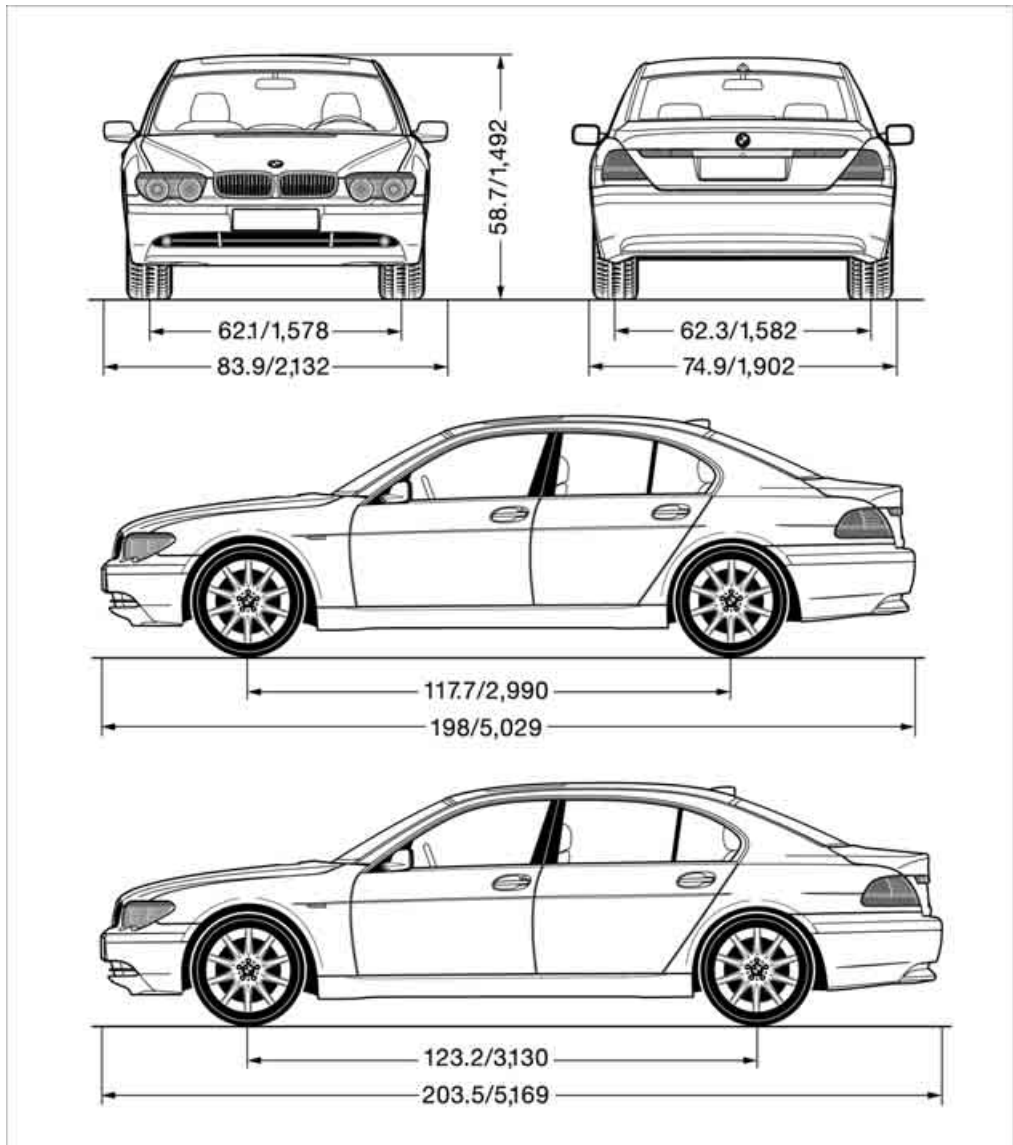

All dimensions specified in inches/mm. Lower side view: Li models.
Min. turning circle dia.: 39.7 ft/12.1 m; Li models: 41.3 ft/12.6 m.

Weights

| | | 745i | 745Li |
|-------------------------------|---------|-------------|-------------|
| Curb weight | lbs./kg | 4,376/1,985 | 4,464/2,025 |
| Approved gross vehicle weight | lbs./kg | 5,434/2,465 | 5,523/2,505 |
| Load | lbs./kg | 1,058/480 | 1,059/480 |
| Approved front axle load | lbs./kg | 2,557/1,160 | 2,602/1,180 |
| Approved rear axle load | lbs./kg | 2,987/1,355 | 3,020/1,370 |
| Approved roof load capacity | lbs./kg | 220/100 | |
| Luggage compartment volume | cu ft/l | 17.7/500 | |

| | | 760i | 760Li |
|-------------------------------|---------|-------------|-------------|
| Curb weight | lbs./kg | 4,762/2,160 | 4,872/2,210 |
| Approved gross vehicle weight | lbs./kg | 5,820/2,640 | 5,930/2,690 |
| Load | lbs./kg | 1,058/480 | 1,058/480 |
| Approved front axle load | lbs./kg | 2,778/1,260 | 2,833/1,285 |
| Approved rear axle load | lbs./kg | 3,109/1,410 | 3,109/1,410 |
| Approved roof load capacity | lbs./kg | 220/100 | 220/100 |
| Luggage compartment volume | cu ft/l | 17.7/500 | 17.7/500 |

Never exceed either the approved axle loads or the gross vehicle weight.

Capacities

| | | | Notes |
|--|---------------|-----------------|--|
| Fuel tank | gal./liters | approx. 23.3/88 | |
| Reserve | gal./liters | approx. 2.6/10 | Fuel specification: page 187 |
| Windshield and headlight washer system | quarts/liters | approx. 6.3/6.0 | For details: page 73 |
| Engine with oil filter change | | | BMW High Performance Synthetic Oil. |
| 745i, 745Li | quarts/liters | 8.5/8.0 | |
| 760i, 760Li | quarts/liters | 9.0/8.5 | Specifications: page 196 |

Everything from A to Z

Index

A

- A/C operation
 - automatic climate control [105](#)
- "ABC..." for navigation [132](#)
- ABS Antilock Brake System [92](#)
 - indicator lamp [13](#)
- ACC, refer to Active cruise control [75](#)
- "ACCEPT" for navigation [137](#), [143](#)
- Accepting call
 - automatic [177](#)
 - during a call [179](#)
- Accessories, refer to Your individual vehicle [5](#)
- Accident, refer to
 - Giving and receiving assistance [209](#)
 - Roadside Assistance [182](#)
- "ACTIVATE", BMW Assist [182](#)
- Activated-charcoal filter [108](#)
- Active cruise control [75](#)
 - malfunction [80](#)
- Active head restraints, front [49](#)
- Active seat [53](#)
- Active seat ventilation [52](#)
- Adapter for spare key [35](#)
- Adaptive Head Light [101](#)
- Address
 - deleting [143](#)
 - displaying [142](#)
 - entering [143](#)
 - storing [142](#)
 - storing current position [143](#)
- "Address book" for navigation [142](#)
- Adjust cooling capacity of rear air conditioner [109](#)
- Adjusting interior temperature [105](#)
- Adjusting seats [47](#)
- Air, drying, refer to A/C operation [105](#)
- Airbags [98](#)
 - indicator lamp [13](#)
 - safe sitting position [46](#)
- Air conditioner in the rear [109](#)
- Air conditioner mode [105](#)
- Air conditioning in rear [109](#)
- Air conditioning while parked [110](#)
- Air distribution
 - automatic climate control [104](#), [107](#)
 - individual [108](#)
- Airing, refer to Ventilation [106](#), [110](#)
- Air jets, refer to Ventilation [106](#), [110](#)
- Air pressure, refer to Tire inflation pressure [188](#)
- Air recirculation, refer to Recirculated air [105](#)
- Air supply
 - automatic climate control [105](#)
 - rear air conditioner [109](#)
- Air vents, refer to Ventilation [106](#)
- AKI, refer to Fuel specifications [187](#)
- Alarm system [42](#)
 - avoiding unintentional alarms [43](#)
- All-season tires, refer to Winter tires [193](#)
- Altering stretch of road [140](#)
- Alternate route, refer to Detour [140](#)
- "AM..."
 - audio mode [148](#)
 - radio [152](#), [154](#)
- AM waveband [152](#)
- "ANGLE" for DVD mode [169](#)
- Antenna [174](#)
- Antenna for portable phone [174](#)
- Antifreeze
 - coolant [196](#)
 - washer fluid [73](#)
- Antilock Brake System ABS
 - indicator lamp [13](#)
- Anti-theft alarm system [35](#)
 - refer to Alarm system [42](#)
- Anti-trapping mechanism
 - glass roof, electric [45](#)
 - power windows [44](#)
- Armrest, refer to Center armrest [115](#), [118](#)
- "Arrow display" for navigation [139](#), [140](#)
- Arrow display for navigation [140](#)
- "AS ADDRESS", navigation
 - creating directory [142](#)
 - current position [143](#)
 - destination entry [133](#)
 - destination list [137](#)
 - home address [142](#)
 - recent destinations [136](#)
- "AS DEST.", navigation
 - recent destinations [136](#)
- Ashtray [117](#)
 - front [117](#)
 - rear [117](#)
- Assist [182](#)
- Assistance system, refer to DSC Dynamic Stability Control [93](#)
- Assistance window
 - help texts [22](#)
 - refer to Control Center [22](#)
 - status lines [23](#)
- AUC Automatic recirculated-air control [105](#)

"Audio"
– audio mode [148](#)
– radio [152](#)
Audio [148](#)
– adjusting tone [149](#)
– controls [148](#)
– switching on/off [149](#)
– volume [149](#)
"AUDIO" for
 DVD mode [169](#)
Audio mode [148](#)
"AUTO", automatic climate
 control [107](#)
Automatic
– air distribution [104](#)
– air supply [104](#)
– headlamp control [100](#)
– luggage compartment lid
 operation [36](#), [41](#)
– steering wheel
 adjustment [54](#)
– windshield washer [72](#)
Automatic car wash, refer
 to the Caring for your
 vehicle brochure
Automatic climate
 control [103](#)
– rear air conditioner [109](#)
– rear cooler [114](#)
– settings in Control
 Display [107](#)
Automatic curb monitor [56](#)
Automatic Hold
– parking [65](#)
– parking brake [65](#)
Automatic recirculated-air
 control AUC [105](#)
Automatic soft closing
– doors [39](#)
– luggage compartment
 lid [40](#)
Automatic station
 search [152](#)
Automatic station
 storage [153](#)

Automatic transmission
 with Steptronic [68](#)
– ignition [62](#)
– interlock [62](#)
– selector lever interlock [68](#)
– shiftlock [69](#)
– towing [210](#)
"AUTO P"
– function button [54](#)
– vehicle [65](#)
AUTO program, refer to
 Automatic air
 distribution [104](#)
"AUTOSTOR" for radio [154](#)
Average fuel
 consumption [86](#)
– setting units [89](#)
Average speed [86](#)
– setting units [89](#)
"Avoid highway" [137](#)
Avoiding tolls [137](#)
"Avoid route" [141](#)
"Avoid sect." [140](#)
"Avoid tolls" [137](#)
Axle loads, refer to
 Weights [216](#)
"A-Z", telephone [179](#)

B

Backrests, refer to Seat
 adjustment [47](#), [48](#)
Backrest width
 adjustment [47](#)
Backup lamps, bulb
 replacement [203](#)
"Balance" in audio
 mode [150](#)
Bandages, refer to
 First-aid kit [209](#)
Bar, towing [211](#)
"Bass" in audio mode [150](#)
Battery [207](#)
– indicator lamp [207](#)
– jump-starting [209](#)
– remote control [34](#)
– switch [207](#)
"BC", refer to Computer [87](#)
Belts, refer to Safety
 belts [51](#)
Beverage holders [116](#)

Blower, automatic climate
 control [103](#)
BMW active seat [53](#)
"BMW Assist" [182](#)
BMW Assist [182](#)
BMW Maintenance
 System [198](#)
"BMW Services",
 BMW Assist [182](#)
Bottle holder, refer to
 Beverage holders [116](#)
Brake fluid [197](#)
– indicator lamp [13](#)
– level [197](#)
Brake Force Display [97](#)
Brake hydraulic
 systems [197](#)
Brake lamps
– adaptive, refer to Brake
 force display [97](#)
– bulb replacement [203](#)
– indicator lamp, defective
 lamp [83](#)
Brake pad wear indicator,
 indicator lamp [13](#)
Brake rotors
– brake system [123](#)
– break-in [122](#)
Brakes [123](#)
– ABS [92](#)
– brake fluid [197](#)
– break-in [122](#)
– indicator/warning
 lamps [13](#), [92](#), [94](#)
– parking brake [64](#)
Brake system [197](#)
– brake fluid level [197](#)
– brake pads [82](#)
– break-in [122](#)
– disc brakes [123](#)
– indicator lamp [13](#)
Breakdown recovery, refer
 to Roadside
 Assistance [182](#)
Breakdown service, refer to
 Roadside Assistance [182](#)
Break-in procedures [122](#)
"Brief info", Control
 Center [22](#)

- "Brightness"
 - in the Control Center [90](#)
 - in TV mode [164](#)
- Brightness [90](#)
 - in TV mode [164](#)
 - on Control Display [90](#)
- Bulb replacement, refer to Lamps and bulbs [201](#)
- Buttons on multi-function steering wheel [16](#)
 - automatic transmission with Steptronic [70](#)
- Bypassing traffic congestion [140](#)

C

- Calculating distance [86](#)
- California laws
 - Event Data Recorders [200](#)
 - Proposition 65 Warning [200](#)
- Call
 - beginning [178](#)
 - during a call [179](#)
 - ending [178](#)
 - replacing [179](#)
 - when absent [181](#)
- Calling
 - from phone book [179](#)
 - from the Top 8 list [180](#)
 - redialing [180](#)
 - with telephone keypad, folding [176](#)
- Calls, switching between two calls [179](#)
- Can holder, refer to Beverage holders [116](#)
- Capacities [217](#)
- Car care, refer to the Caring for your vehicle brochure
- Car-care products, refer to the Caring for your vehicle brochure
- "Car data", vehicle [84](#)
- Care, refer to the Caring for your vehicle brochure
- Caring for the vehicle finish, refer to the Caring for your vehicle brochure
- Car jack points [205](#)

- Car key, refer to Key/remote control [34](#)
- Carpet care, refer to the Caring for your vehicle brochure
- Car phone, refer to separate portable phone Owner's Manual [174](#)
- Car radio, refer to Radio [152](#)
- Car wash [122](#)
 - refer to the Caring for your vehicle brochure
 - with Comfort Access [122](#)
- Catalytic converter, refer to High temperatures [122](#)
- CBC Cornering Brake Control [92](#)
 - warning lamp [13](#)
- CBS Condition Based Service [198](#)
- "CD"
 - in audio mode [148](#)
 - in CD player mode [158](#)
- CD changer [160](#)
 - adjusting tone [149](#)
 - controls [148](#)
 - fast forward, reverse [162](#)
 - location [160](#)
 - random sequence [161](#)
 - sampling [161](#)
 - selecting a CD [161](#)
 - selecting track [162](#)
 - starting [160](#)
 - volume [149](#)
- CD player [158](#)
 - adjusting tone [149](#)
 - controls [148](#)
 - fast forward, reverse [159](#)
 - random sequence [158](#)
 - sampling [158](#)
 - selecting tracks [158](#)
 - starting [158](#)
 - volume [149](#)
- Center armrest [115, 118](#)
- Center brake lamp, bulb replacement [203](#)
- Center console, refer to Comfort features [14](#)
- Central locking system [35](#)
 - Comfort Access [37](#)
 - interior [38](#)
- "CHANGE" for navigation [137](#)
- Changes, technical, refer to For your own safety [5](#)
- Changing language [89](#)
- Changing navigation CDs/DVDs [130](#)
- Changing scale [140](#)
- Changing settings on the Control Display [89](#)
- Changing time display [89](#)
- Changing units of measure in Control Display [89](#)
- Changing wheels [204](#)
- Charge current indicator lamp [83](#)
- CHECK button [84](#)
- Check Control [83](#)
 - "Check" [84](#)
- Child's seats, refer to Child-restraint systems [58](#)
- Child-restraint systems [58](#)
- Child-safety lock [60](#)
- Chrome parts, refer to the Caring for your vehicle brochure
- Chrome-plated parts, care, refer to the Caring for your vehicle brochure
- Cigarette lighter [117, 118](#)
- Cleaning, vehicle, refer to the Caring for your vehicle brochure
- Cleaning windshield [72](#)
- Climate comfort windshield [126](#)
- "Climate" for seat heating [52](#)
- "Clock" [90](#)
- Clock [81](#)
 - 12/24-hour mode [89](#)
 - setting [90](#)
 - setting time and date [90](#)
- Closing
 - from inside [38](#)
 - from outside [35](#)
- Clothes hooks [116](#)
- Cockpit [10, 14](#)

Coin holder, refer to
Storage compartments [115](#)
Cold start, refer to Starting engine [63](#)
"Color" in TV mode [164](#)
Comfort Access [37](#)
– changing battery [37](#)
– observe in the car wash [122](#)
Comfort features [14](#)
Comfort mode, vehicle [95](#)
Comfort seat [47](#)
– in rear [48](#)
Comfort starting, refer to Starting engine [63](#)
"Comm.",
Control Center [24](#)
Compact Disc, refer to
– CD changer [160](#)
– CD player [158](#)
Compartments, refer to Storage compartments [115](#)
Computer [85](#)
– "BC" [87](#)
– Control Display screen contents [87](#)
Condensation, refer to A/C operation [122](#)
Condition Based Service CBS [198](#)
Configuring adjustments [56](#)
"CONFIRM", vehicle [83](#)
Connecting a car vacuum cleaner, refer to Lighter socket [117](#)
Consumption, refer to Average consumption [86](#)
Consumption display, refer to
– Control Display screen contents [87](#)
– Fuel gauge [85](#)
Contents [3](#)
"Contrast" in TV mode [164](#)
Contrast in TV mode [164](#)

Control Center [17](#)
– adjusting the brightness [90](#)
– assistance window [22](#)
– automatic climate control [107](#)
– changing menu page [19](#)
– changing settings [89](#)
– confirming selection or entry [18](#)
– display, menus [21](#)
– displaying help text [22](#)
– language selection [89](#)
– lists [19](#)
– menu item selection [18](#)
– menus [21](#)
– rear [24](#)
– selecting units of measure and display format [89](#)
– setting time and date [90](#)
– status lines [23](#)
– symbols [20](#)
– symbols and lists [19](#)
Control Display [18](#)
– rear [24](#)
Controller, refer to Control Center [17](#)
Controls [10, 14](#)
– refer to Cockpit [10, 14](#)
Convenience operation
– from inside [38](#)
– from outside [36, 38](#)
– glass roof, electric [36, 38](#)
– windows [36, 38](#)
Coolant [196](#)
– indicator lamp [83](#)
– level [196](#)
– temperature gauge [83](#)
Cooler, refer to Rear cooler [114](#)
Cooling
– maximum [105, 109](#)
– refer to Temperature [105](#)
Cooling system [196](#)
Copyright [2](#)
Cornering Brake Control CBC [92](#)
Creating voice address book [143](#)

Cruise control [73, 75](#)
– indicator lamp [11](#)
– multi-function steering wheel [11](#)
Cruising range [86](#)
Cup holder, refer to Beverage holders [116](#)
Curb weight, refer to Weights [216](#)
Current fuel consumption [86](#)
Current position
– correcting [143](#)
– displaying [143](#)
– entering [143](#)
– storing [143](#)
Cylinders, refer to Engine specifications [214](#)

D

Dashboard [10, 14](#)
Data [214](#)
– dimensions [215](#)
– engine [214](#)
– filling capacities [217](#)
– technical [214](#)
– weights [216](#)
"Date" [90](#)
Date [90](#)
– changing [90](#)
– display format [89](#)
– displaying [90](#)
Daytime driving lamps [100](#)
DBC Dynamic Brake Control [94](#)
– indicator lamp [13](#)
Defect
– door lock [38](#)
– fuel filler door [186](#)
– glass roof, electric [45](#)
– luggage compartment lid [41](#)
Defective lamp [201](#)
Defroster
– rear window [104](#)
– windshield [105](#)
Defrosting position, refer to Defrosting windows [105](#)

- Defrosting windows [105](#)
 - automatic climate control [105](#)
- Defrosting windows and removing condensation, automatic climate control [105](#)
- Defrosting windshield, refer to Defrosting windows [105](#)
- "DELETE" for navigation [136](#), [137](#)
- Destination address
 - deleting [137](#)
 - entering [134](#)
- Destination for navigation [132](#)
 - selecting using voice [142](#)
 - selecting via information [135](#)
- Destination guidance [139](#)
 - changing route specifications [137](#)
 - continuing [142](#)
 - displaying driving route [131](#)
 - distance and arrival [86](#)
 - interrupting [142](#)
 - interrupting voice instructions [141](#)
 - selecting new route [140](#)
 - starting [139](#)
 - terminating [142](#)
 - volume of voice instructions [141](#)
- Destinations recently driven to [137](#)
- "Dest. input" for navigation [132](#)
- "Detour" for navigation [141](#)
- Dialed numbers for telephone [180](#)
- Differential, break-in [122](#)
- Digital clock [81](#)
- Dimensions [215](#)
- Dimmed interior mirror [53](#)
- Dipstick, engine oil [195](#)
- Directional indicators, refer to Turn signals [71](#)
- Direction instruction, refer to Voice instructions [141](#)
- Directory, refer to
 - Address book [142](#)
 - Phone book [179](#)
- Disc brakes [123](#)
- Displacement, refer to Engine specifications [214](#)
- Display, refer to Control Display [18](#)
- Display direction, altering [140](#)
- Display elements [12](#)
- Display illumination [101](#)
- Display lighting, refer to Instrument lighting [101](#)
- Display of faults [83](#)
- Displays, refer to Info Display [12](#)
- Disposal
 - battery of remote control [37](#)
 - vehicle battery [207](#)
- Distance [86](#)
 - unit of measure [89](#)
- Distance control, refer to Active cruise control [75](#)
- Distance to destination [86](#)
- Distance warning [91](#)
- Door entry lighting [102](#)
- Door keys [34](#)
- Door lock [38](#)
- DOT Quality Grades [190](#)
- Draft-free ventilation [106](#)
- Driving lamps, refer to Parking lamps/ low beams [100](#)
- Driving notes [122](#)
- Driving stability control [92](#)
- Driving through water, flooding [123](#)
- Driving time [87](#)
- Dry air, refer to A/C operation [105](#)
- "DSC", vehicle [94](#)
- DSC Dynamic Stability Control [93](#)
 - indicator lamp [13](#)
- "DTC", vehicle [93](#)
- DTC Dynamic Traction Control [93](#)
 - indicator lamp [13](#)
- "DVD"
 - in audio mode [148](#)
 - in DVD mode [166](#)
- DVD changer [165](#)
 - adjusting picture [168](#)
 - adjusting tone [149](#)
 - controls [148](#)
 - country codes [166](#)
 - DVD controller [166](#)
 - fast forward [167](#)
 - fast reverse [167](#)
 - freezing frame [168](#)
 - searching for chapter [168](#)
 - selecting a track [167](#)
 - selecting DVD [167](#)
 - selecting language [168](#)
 - selecting picture format [168](#)
 - selecting subtitles [168](#)
 - specific menu [169](#)
 - starting [166](#)
 - volume [149](#)
- DVD multimedia changer, refer to DVD changer [165](#)
- Dynamic Brake Control DBC [94](#)
 - indicator lamp [13](#)
- Dynamic destination guidance, traffic information during destination guidance [140](#)
- Dynamic Drive [95](#)
- Dynamic Stability Control DSC [93](#)
 - indicator lamp [13](#)
- Dynamic Traction Control DTC [93](#)
 - indicator lamp [13](#)

E

- EBV Electronic brake-force distribution [93](#)
- EDC Electronic Damping Control [95](#)
- Editorial notice [5](#)

Electrical defect
– door lock **38**
– driver's door **38**
– fuel filler door **186**
– glass roof, electric **45**
– luggage compartment lid **40**
– parking brake **66**
– transmission interlock for automatic transmission with Steptronic **70**
Electric steering wheel adjustment **54**
Electronic Damping Control EDC **95**
Electronic Stability Program ESP, refer to DSC Dynamic Stability Control **93**
Electronic toll collection device, refer to Entry/pass tags **126**
Emergency actuation, refer to Manual operation
– driver's door **38**
– fuel filler door **186**
– glass roof, electric **45**
– luggage compartment lid **40**
– parking brake **66**
– transmission interlock for automatic transmission with Steptronic **70**
Emergency call **177**
– dialing phone number **178**
– with emergency call button **177**
Emergency release of luggage compartment lid from luggage compartment's interior **41**
Emergency services, refer to Roadside Assistance **182**
"Emissions inspection", vehicle **83**
Energy-conscious driving, refer to Energy Control **86**
Energy Control **86**
Engaging locks from inside **39**

Engine
– break-in **122**
– data **214**
– indicator lamp **13**
– speed **214**
– starting **63**
– switching off **63**
Engine compartment **195**
Engine coolant **196**
Engine oil **195**
– filling capacity **217**
– indicator/warning lamp **83**
– specified engine oils **196**
Engine oil level **195**
Engine oil pressure **83**
Engine oil sensor **83**
Engine output, refer to Engine specifications **214**
Engine specifications **214**
Engine speed **214**
Entering country **133**
Entering house number **134**
Entering intersection **134**
Entering street **134**
Entering switch-on time of independent ventilation system **110**
"Entertainm.", Control Center **24**
"Entertainment" in audio mode **148**
Entry/pass tags **126**
Entry map for current position and destination **132**
Environmentally friendly driving, refer to Energy Control **86**
Equalizer **150**
ESP Electronic Stability Program, refer to DSC Dynamic Stability Control **93**
Exhaust system, refer to High temperatures **122**
Exterior mirrors **53**
– automatic dimming feature **53**
"Extra"
– rear air conditioning **109**
– rear cooler **114**

F

"Fader" in audio mode **150**
Failure messages **13**
– refer to Check Control **83**
Failure of a current consumer **207**
False alarm, refer to Avoiding unintentional alarms **43**
Fan, refer to Air supply **105**
Fasten safety belt **51**
Fastest route **137**
"Fastest route" for navigation **137**
Fast forward
– CD **159, 162**
– DVD **167**
Fault displays, refer to Check Control **83**
Filter, refer to Microfilter/activated-charcoal filter **108**
Fine wood, refer to the Caring for your vehicle brochure
First aid, refer to First-aid kit **209**
First-aid kit **209**
Fittings for tow-starting and towing **210**
Flashlight, refer to Rechargeable flashlight **115**
Flat tire **206**
– Flat Tire Monitor **95**
– refer to Tire condition **191**
– run-flat tires **206**
– spare tire **205**
Flat Tire Monitor **95**
– indicator lamp **96**
Flooding, refer to Driving through water **123**
Floor coverings, carpet, refer to the Caring for your vehicle brochure
Floor mat, refer to the Caring for your vehicle brochure

"FM..."

- audio mode [148](#)
- radio [152](#)

FM, waveband [152](#)

Fog lamps [101](#)

- indicator lamp [11](#)

Footbrake, refer to
Driving notes [123](#)

Front airbags [98](#)

Front armrest [115](#)

Front fog lamps

- indicator lamp [11](#)

Front passenger airbags,
deactivating [58](#)

Fuel [187](#)

- average consumption [86](#)
- gauge [86](#)
- quality [187](#)
- volume [217](#)

Fuel filler door [186](#)

- releasing in the event of
an electrical defect [186](#)

Fuel level, refer to

Fuel gauge [85](#)

Fuel level gauge, refer to

Fuel gauge [85](#)

Fuel level indicator, refer to
Fuel gauge [86](#)

Fuel-saving driving, refer to
Energy Control [86](#)

Fuel tank capacity [217](#)

"FULL MENU" in DVD
mode [167](#), [168](#)

"Full Release",
Control Center [24](#)

Fuses [207](#)

G

Garage door opener, refer
to Integrated universal
remote control [112](#)

Gasoline, refer to Fuel
specifications [187](#)

Gear changes, refer to
Automatic transmission
with Steptronic [70](#)

Gear indicator [68](#)

General driving notes [122](#)

Glasses compartment [116](#)

Glass roof, electric,
convenience
operation [36](#), [38](#)

Glove compartment [115](#)

GPS, refer to Navigation
system [130](#)

Grills, refer to
Ventilation [106](#)

Gross weight, refer to
Weights [216](#)

H

Handbrake [64](#)

- Automatic Hold [65](#)
- indicator lamp [13](#)

Hands-free mode [177](#)

Hands-free system [177](#)

Hazard warning flashers [15](#)

Head airbags [98](#)

Headlamp control,
automatic [100](#)

Headlamp cover, care,
refer to the Caring for
your vehicle brochure

Headlamp flasher [71](#)

- indicator lamp [13](#)

Headlamps [100](#)

- bulb replacement [201](#)
- care, refer to the Caring
for your vehicle brochure

Headlamp washer fluid
tank, capacity, refer to

Filling capacities [217](#)

Headlamp washer system
- cleaning headlamps [72](#)

- fluid tank [73](#)

- washer fluid [73](#)

Head Light, refer to
Adaptive Head Light [101](#)

Headphones [25](#)

Head restraints [49](#)

- front head restraints,
active [49](#)

Heated mirrors [53](#)

Heated rear window,
automatic climate
control [104](#)

Heated seats [52](#)

Heated steering wheel [54](#)

Heated windshield,
automatic climate
control [105](#)

Heating [103](#)

- exterior mirrors [53](#)

- seats [52](#)

- steering wheel [54](#)

Heating and ventilation [103](#)

Heating while stopped [105](#)

Heavy cargo, refer to
Stowing cargo [124](#)

Height, refer to
Dimensions [215](#)

Height adjustment

- seats [47](#)
- steering wheel [54](#)

"Help", Control Center [22](#)

Help text on Control
Display [22](#)

High beams [101](#)

- bulb replacement [202](#)

- headlamp flasher [101](#)

- indicator lamp [13](#)

Highs, refer to Tone
settings [150](#)

High temperatures [122](#)

Highway [137](#)

Hills [123](#)

Holders for beverage
cans [116](#)

Home address [142](#), [143](#)

Hood [194](#)

Horn [11](#)

Hydraulic Brake Assistant,
refer to DBC Dynamic
Brake Control [94](#)

Hydraulic system,
brakes [197](#)

Hydroplaning [123](#)

I

Ice warning [81](#)

iDrive, refer to
Control Center [17](#)

Ignition [62](#)

Ignition key [34](#)

Ignition lock [62](#)

- with Comfort Access [62](#)

Illuminated vanity mirror [54](#)

Imitation leather, refer to the Caring for your vehicle brochure

Independent ventilation

- entering switch-on times [110](#)
- switching on and off [110](#)

"Indep. ventil", independent ventilation [110](#)

Index [218](#)

Indicator/warning lamp

- airbags [99](#)
- alarm system [42](#)
- brakes [13](#)
- coolant temperature [83](#)
- DSC [93](#)
- engine temperature [83](#)
- fasten safety belt [51](#)
- Flat Tire Monitor [96](#)
- fog lamps [101](#)
- reserve [86](#)

Indicator and warning lamps, overview [13](#)

"Individual", automatic climate control [108](#)

Individual adjustments, refer to Vehicle Memory, Key Memory [56](#)

Individual air distribution [108](#)

Individual button assignment [17](#)

- on steering wheel [54](#)

Inflation pressure, tires [188](#)

Inflation pressure monitoring, refer to Flat Tire Monitor [95](#)

Info Display [12](#)

Info menu [22](#)

Information

- on country [135](#)
- on current position [135](#)
- on destination location [135](#)

"Information" for navigation [135](#), [136](#)

Information on travel direction, refer to Voice instructions [141](#)

Infrared windshield, refer to Entry/pass tags [126](#)

Instrument cluster, refer to Info Display [12](#)

Instrument illumination, refer to Instrument lighting [101](#)

Instrument lighting [101](#)

Instrument panel, refer to Cockpit [10](#), [14](#)

Integrated universal remote control [112](#)

Interesting destination [136](#)

Interior lamps [102](#)

- remote control [36](#)

Interior mirror, automatic dimming feature [53](#)

Interior motion sensor [43](#)

- switching off [43](#)

Interior rearview mirror [53](#)

Interlock, refer to Steering locked [62](#)

Intermittent operation, wiper [72](#)

J

Jacking points for vehicle jack [205](#)

Joystick, refer to Control Center [17](#)

Jumpering, refer to Jump-starting [209](#)

Jump-starting [209](#)

K

Keyless Go, refer to Comfort Access [37](#)

Keyless opening and closing, refer to Comfort Access [37](#)

Key Memory [56](#)

Keys [34](#)

- adapter for spare key [34](#)

Kick-down [69](#)

Knock control [187](#)

L

Lamps, refer to Parking lamps/low beams [100](#)

Lamps and bulbs [201](#)

Lashing eyes, refer to Securing cargo [125](#)

"Last dest." for navigation [136](#)

"Last" for telephone [180](#)

LATCH child-restraint fixing [60](#)

Leather care, refer to the Caring for your vehicle brochure

LEDs light-emitting diodes [204](#)

"Left"

- for seat heating [52](#)
- with the automatic climate control [107](#)

Length, refer to Dimensions [215](#)

Level control system [97](#)

License plate lamp, bulb replacement [203](#)

Light alloy wheels, care, refer to the Caring for your vehicle brochure

Light-emitting diodes [204](#)

Lighter [117](#), [118](#)

Lighter socket [117](#)

Lighting

- of instruments [101](#)
- of vehicle [100](#)

Lights on warning [100](#)

Light switch [100](#)

Limit [87](#)

"Limit", refer to Setting speed limit [88](#)

"Limited Release", Control Center [24](#)

Lists in Control Display [19](#)

Litter container [115](#)

Load, refer to Loading [124](#)

Loading, vehicle [124](#)

Location

- CD changer [160](#)
- DVD changer [165](#)
- navigation drive [130](#)
- telephone [176](#), [178](#)

"Location" for navigation [135](#), [142](#), [143](#), [144](#)
 Lock buttons, doors, refer to Engaging locks [39](#)
 Lock code [178](#)
 Locking, vehicle
 – from inside [39](#)
 – from outside [36](#)
 Locking without key, refer to Comfort Access [37](#)
 "LOGIC7" in audio mode [150](#)
 Longlife oils [196](#)
 – specified engine oils [196](#)
 Low beams [100](#)
 – automatic [100](#)
 – indicator lamp, defective lamp [83](#)
 Lower back support, refer to Lumbar support [48](#)
 Low-fuel warning light, refer to Fuel gauge [86](#)
 Lug bolts [205](#)
 Luggage compartment
 – Comfort Access [37](#)
 – locking separately [40](#)
 – opening, remote control [36](#)
 – opening/closing, refer to Luggage compartment lid [39](#)
 – opening from inside [40](#)
 – opening from outside [39](#)
 – remote control [36](#)
 – volume [216](#)
 Luggage compartment lid [39](#)
 – Comfort Access [37](#)
 – emergency release, refer to Manual operation [40](#), [41](#)
 – indicator lamp [83](#)
 – locking separately [40](#)
 – manually unlocking [39](#)
 – opening, remote control [36](#)
 – opening from inside [40](#)
 – opening from outside [39](#)
 – operation, automatic [36](#), [41](#)
 – remote control [36](#)

Luggage compartment net [42](#)
 Luggage rack, refer to Roof-mounted luggage rack [125](#)
 Luggage strap [125](#)
 Lumbar support [47](#), [48](#)

M

M+S tires, refer to Winter tires [193](#)
 Maintenance [82](#)
 Maintenance System [198](#)
 Make-up mirror, refer to Illuminated vanity mirror [54](#)
 "MANUAL" for radio [153](#)
 Manual operation
 – door lock [38](#)
 – driver's door [38](#)
 – glass roof, electric [45](#)
 – parking brake [66](#)
 – transmission interlock for automatic transmission with Steptronic [70](#)
 Manual release
 – fuel filler door [186](#)
 – luggage compartment lid [40](#)
 Manual station search [153](#)
 Manufacturer [5](#)
 Map
 – changing scale [27](#), [135](#)
 – destination entry [135](#)
 "Map dir. travel" for navigation [139](#), [140](#)
 "Map facing N." for navigation [139](#), [140](#)
 Map facing north [139](#)
 Marking, tires [190](#)
 Master key [34](#)
 – with remote control [34](#)
 Maximum cooling [105](#)
 Maximum roof weight [216](#)
 "Memo" [90](#)
 Memo [90](#)
 "Memorize", automatic climate control [108](#)
 "MEMORIZE" for radio [154](#)

Memory, refer to
 – Seat, mirror and steering wheel memory [55](#)
 – Vehicle Memory, Key Memory [56](#)
 MENU button [18](#)
 "MENU" for DVD mode [169](#)
 "Menu name",
 Control Center [22](#)
 Menus, Control Display [21](#)
 Microfilter, automatic climate control [108](#)
 Microphone for voice command [177](#)
 Mirrors [53](#)
 – automatic curb monitor [56](#)
 – dimming feature [53](#)
 – memory, refer to Seat, mirror and steering wheel memory [55](#)
 – mirror heating [53](#)
 Missed calls, on Control Display [181](#)
 "Missed" for telephone [181](#)
 Mobile service [182](#)
 Modifications, technical, refer to For your own safety [5](#)
 Monitor
 – refer to Control Center [17](#)
 – refer to Control Center in rear [24](#)
 Most recent portable phone numbers [180](#)
 Multi-function steering wheel [10](#), [16](#)
 Multi-function switch
 – turn signals/headlamp flasher [71](#)
 – wiper system [72](#)
 Multimedia monitor, refer to Control Display [18](#)
 Music track, sampling [158](#), [161](#)

N

- "Name" for navigation [133](#)
 - "Navigation" [131](#)
 - Navigation destination
 - manual entry [132](#)
 - selecting from the directory [134](#)
 - selecting via map [135](#)
 - Navigation drive, location [130](#)
 - Navigation system [130](#)
 - address book [142](#)
 - adjusting volume [27](#), [141](#)
 - current position [143](#)
 - destination entry [132](#)
 - destination guidance in assistance window [131](#)
 - destination list [137](#)
 - displaying route [139](#)
 - looking for interesting destination [136](#)
 - manually entering destination address [132](#)
 - navigation CD/DVD [130](#)
 - new route [140](#)
 - recent destinations [136](#)
 - route list [140](#)
 - selecting destination via information [135](#)
 - selecting destination via map [135](#)
 - selecting route criteria [137](#)
 - starting destination guidance [139](#)
 - switching off, refer to Terminating/interrupting destination guidance [142](#)
 - terminating/interrupting destination guidance [142](#)
 - voice instructions [141](#)
 - "Navi info.", function button [54](#)
 - Neck restraints, refer to Head restraints [49](#)
 - Nets [125](#)
 - "New route" for navigation [140](#)
 - "Next"
 - looking for interesting destinations [136](#)
 - selecting destination via map [135](#)
 - "None Release", Control Center [24](#)
 - Notepad function [28](#)
 - Notepad of voice command system [28](#)
 - Nozzles, refer to Ventilation [106](#), [110](#)
 - Nylon rope [210](#)
- ## O
- OBD socket [200](#)
 - Octane numbers, refer to Fuel specifications [187](#)
 - Odometer [81](#)
 - refer to Trip odometer [81](#)
 - Oil
 - additives, refer to Diesel engine [196](#)
 - dipstick [195](#)
 - filling capacity [217](#)
 - specified engine oils [196](#)
 - viscosity ratings [196](#)
 - Oil change intervals, refer to Service requirement display [82](#)
 - Oil consumption [195](#)
 - Oil filter change [217](#)
 - Oil level [195](#)
 - indicator lamp [83](#)
 - Oil pressure, indicator lamp [83](#)
 - Oil sensor, indicator lamp [83](#)
 - Oil temperature [83](#)
 - "OK" for DVD mode [169](#)
 - Onboard computer refer to Control Center [17](#)
 - Onboard tool kit [201](#)
 - "On country" for navigation [136](#)
 - "1,2,3" [179](#)
 - "On location" for navigation [135](#)
 - "On town/city" for navigation [136](#)
 - Opening and closing
 - from inside [38](#)
 - from outside [35](#)
 - via door lock [38](#)
 - with remote control [35](#)
 - Opening without key, refer to Comfort Access [37](#)
 - Oral note [28](#)
 - Outside air [105](#)
 - Outside air mode, automatic climate control [105](#)
 - Outside temperature display [81](#)
 - changing unit of measure [89](#)
 - Overview
 - operating principle [10](#)
 - radio control [148](#)
- ## P
- Panic mode [36](#)
 - Park detent, refer to Transmission lockout [69](#)
 - Park Distance Control PDC [91](#)
 - Parking, vehicle [64](#)
 - Parking aid, refer to PDC Park Distance Control [91](#)
 - Parking brake [64](#)
 - Automatic Hold [65](#)
 - manual operation [64](#)
 - Parking lamps [100](#)
 - bulb replacement [202](#)
 - Parking lamps/low beams [100](#)
 - "Parking lamps on!", vehicle [85](#)
 - Parking with Automatic Hold [65](#)
 - Parts and accessories, refer to Your individual vehicle [5](#)
 - Passenger-side mirror tilt function [56](#)
 - Pathway lighting [100](#)

PDC Park Distance Control [91](#)
 "PDC pic.", vehicle [92](#)
 Pen tray [116](#)
 Permissible axle load, refer to Weights [216](#)
 Permissible gross weight, refer to Weights [216](#)
 "Perspective" for navigation [139](#)
 Phone book [179](#)
 – deleting all entries [180](#)
 – dialing numbers using voice command system [180](#)
 – entering numbers in voice command phone book [179](#)
 – entry deletion [180](#)
 Phone number
 – deleting [180](#)
 – deleting from list of numbers [180](#)
 – dialing [178](#)
 – dialing from list of numbers [179](#)
 – recent numbers [180](#)
 – refer to Portable phone [178](#)
 – Top 8 [180](#)
 "Pict. format" in DVD mode [168](#)
 "Picture"
 – audio mode [148](#)
 – DVD mode [168](#)
 – TV operation [164](#)
 Plastic, refer to the Caring for your vehicle brochure
 Please fasten safety belt, indicator lamp [13](#)
 Pollen, refer to Microfilter/activated-charcoal filter [108](#)

Portable phone
 – adjusting volume [177](#)
 – battery [175](#)
 – calling [178](#)
 – call termination [178](#)
 – codes [178](#)
 – controlling with the buttons on the steering wheel [16](#)
 – emergency call [177](#)
 – hands-free system [177](#)
 – missed calls [181](#)
 – operating via Control Center [175](#)
 – operating with telephone keypad, folding [176](#)
 – redialing [180](#)
 – refer to separate portable phone Owner's Manual
 – switching on/off [178](#)
 – Top 8 [180](#)
 Power output, refer to Engine specifications [214](#)
 Power rear backrests [48](#)
 Power seat [47, 48](#)
 Power windows [43, 44](#)
 – safety switch [44](#)
 Pressure, tires [188](#)
 Pressure monitoring, tires [95](#)
 – Flat Tire Monitor [95](#)
 Producing tire inflation pressure [188](#)
 Programmable cruise control [73](#)
 Programming settings, refer to Vehicle Memory, Key Memory [56](#)
 Programs, refer to TV [163](#)
 Protective function
 – glass roof, electric [45](#)
 – power windows [44](#)
 Publishers [2](#)
 Puncture, Flat Tire Monitor [95](#)

R

Radiator, refer to Coolant [196](#)
 Radio [152](#)
 – adjusting tone [149](#)
 – Autostore [154](#)
 – briefly play station [153](#)
 – controls [148](#)
 – selecting the waveband [152](#)
 – station search [153](#)
 – station selection [154](#)
 – storing station [154](#)
 – switching on/off [149](#)
 – volume [149](#)
 – Weather Band [155](#)
 Radio-control key, refer to Master key with remote control [34](#)
 Radio mode [62](#)
 – with Comfort Access [62](#)
 Rain sensor [72](#)
 Reading lamps [102](#)
 "Rear", Control Center [24](#)
 Rear, Control Center [24](#)
 Rear air conditioner [109](#)
 – activation and deactivation in Control Display [109](#)
 – air supply [109](#)
 – cooling adjustment [109](#)
 – switching off [109](#)
 Rear armrest, refer to Center armrest [118](#)
 Rear backrests, power [48](#)
 Rear-compartment air conditioning
 – rear cooler [114](#)
 Rear cooler [114](#)
 Rear lamps [203](#)
 – bulb replacement [203](#)
 – indicator lamp, defective lamp [83](#)
 – refer to Tail lamps [203](#)
 Rear lock [24](#)
 Rear-seat area ventilation [106](#)

Rear seats
– adjusting 48
– adjusting passenger seat from the rear 48
– head restraint adjustment 50
– heating 52
Rear seats, power 48
Rear TV 24
Rearview mirror 53
Rear window blind, refer to Sun blinds 113
Rear window defroster, automatic climate control 104
Rear window safety switch 44
Recent destinations, navigation 136
Reception
– radio station 152
– TV programs 163
"Recirc. air", function button 54
Recirculated-air mode, automatic climate control 105
Recirculating air, refer to Recirculated-air mode 105
Reclining seat, refer to Backrest tilt 47, 48
Redialing list, display persons not reached 180
Refueling 186
– fuel filler door 186
"Release", Control Center 24
Releasing
– from outside 36
– luggage compartment lid 36, 37
Remaining distance, refer to Cruising range 86
Remaining distance for service 82, 83

Remote control 34
– changing battery 37
– Comfort Access 37
– garage door opener 112
– luggage compartment lid 36
– malfunctions 37
Replacement fuses 207
Replacement keys 34
Replacement of tires
– changing wheels 204
– tire replacement 192
Replacement tire 205
Replacing lamps, refer to Lamps and bulbs 201
Replacing light bulbs 201
Replacing tires 192
Replacing windshield wipers 201
Reservoir, washer system 73
Reset, resetting tone settings 151
"RESET" in audio mode 151
Residual heat 105
Restraint systems
– for children 58
– refer to Safety belts 51
Returning to starting point 143
Reverse
– CD 159, 162
– DVD 167
Reverse gear, automatic transmission with Steptronic 69
"Right"
– for seat heating 52
– with the automatic climate control 107
"RND"
– CD changer 161
– CD player 158
Road map 135
"Roadside Assistance", BMW Assist 182
Rod antenna, refer to the Caring for your vehicle brochure
Roller sun blind, refer to Sun blinds 113

Roof-mounted luggage rack 125
Rope, refer to Having vehicle towed 210
Route
– altering 140
– displaying 139
– displaying map 139
– list 140
– new 140
– selecting 137
– selecting criteria 137
"Route" for navigation 139, 140
"Route guid." for navigation 139, 142
Route instruction, refer to Voice instructions 141
"Route selec." for navigation 137
"RPA", vehicle 96
RSC Run-flat System Component, refer to Run-flat tires 206
Run-flat System Component RSC, refer to Run-flat tires 206
Run-flat tires 192
– flat tire 206
– tire inflation pressure 188
– tire replacement 192, 193
– winter tires 193

S

Safety belts 51
– care, refer to the Caring for your vehicle brochure
– sitting safely 46
– warning lamp 13, 51
Safety belt tensioners, refer to Safety belts 51
Safety systems, refer to
– ABS Antilock Brake System 92
– Brake system 94
– DSC Dynamic Stability Control 93
Safety tires, refer to Run-flat tires 206

- Sampling, Scan
 - CD [158, 161](#)
 - radio [153](#)
- SAT, waveband [155](#)
- "SCAN"
 - CD changer [161](#)
 - CD player [158](#)
 - radio [153](#)
- Scan
 - CD changer [161](#)
 - CD player [158](#)
 - radio [153](#)
- Scan, sampling
 - CD changer [161](#)
 - CD player [158](#)
 - radio [153](#)
- Screen, refer to Control Display [18](#)
- Screwdriver, refer to Onboard tool kit [201](#)
- Searching for music track, CD [158, 161](#)
- Seat adjustment
 - electric [47, 48](#)
 - electric, BMW sports seat [48](#)
- Seats [47](#)
 - heating [52](#)
 - memory, refer to Seat, mirror and steering wheel memory [55](#)
- "Seat temp." for seat heating [52](#)
- Seat ventilation, refer to Active seat ventilation [52](#)
- Securing cargo, refer to Loading [125](#)
- Securing luggage [125](#)
- Select functions [17](#)
- Selecting audio source [152](#)
- Selecting menu [21](#)
- Selecting roaming [23](#)
- Selector lever, automatic transmission with Steptronic [68](#)
- Selector lever interlock, refer to Shiftlock [69](#)
- Selector-lever positions, automatic transmission with Steptronic [68](#)
- Service, refer to Roadside Assistance [182](#)
- "Service", vehicle [82](#)
- Service and Warranty Information Booklet for US models [198](#)
- Service Interval Display, refer to Service requirement display [82, 198](#)
- Service Mobile, refer to Roadside Assistance [182](#)
- Service requirement display [82, 198](#)
- "SET", refer to Setting speed limit [88](#)
- "Set time 1", independent ventilation [110](#)
- "Set time 2", independent ventilation [110](#)
- Setting button, refer to Controller [17](#)
- "Settings"
 - comfort mode [95](#)
 - Control Center [24](#)
 - function button [54](#)
 - Sport program [95](#)
- Settings
 - data and time [90](#)
 - language [89](#)
 - screen display [22](#)
 - units of measure [89](#)
- Setting time, refer to Preselecting switch-on time [110](#)
- Setting time and date [90](#)
- Shifting, automatic transmission with Steptronic [68](#)
- Shiftlock, refer to Engaging selector lever position [68](#)
- Short commands for voice command system [29](#)
- Shortest route [137](#)
- "Shortest route" for navigation [137](#)
- Shoulder support [48](#)
- Side airbags [98](#)
- Side-mounted turn signals, bulb replacement [202](#)
- Side window blind, refer to Sun blinds [113](#)
- Sitting safely [46](#)
 - with airbags [46](#)
 - with safety belts [46](#)
- Ski bag [118](#)
- Sliding/tilt sunroof, refer to Glass roof, electric [44](#)
- Smokers' package, refer to Ashtray [117](#)
- Snow chains [193](#)
- Socket, refer to Lighter socket [117](#)
- Socket for onboard diagnosis [200](#)
- Soft closure aid, refer to Automatic soft closing [39, 40](#)
- Spare fuses [207](#)
- Spare key [34](#)
 - adapter [34](#)
- Spare tire [205](#)
- Special oils, refer to Specified engine oils [196](#)
- Special washing program, refer to Caring for your vehicle brochure
- Specified engine oils [196](#)
- Speed
 - average [86](#)
 - limit [87](#)
- Speed-dependent volume [150](#)
- Speed limit [87](#)
 - "Limit" [88](#)
- Speed limit "ON/OFF" [88](#)
- Speedometer [12](#)
- "Speed Vol." in audio mode [150](#)
- Sport program
 - automatic transmission with Steptronic [70](#)
 - vehicle [95](#)
- Sports characteristic [95](#)
- Sports seat [48](#)
- Stability control, refer to
 - Driving stability control [93](#)
 - DSC Dynamic Stability Control [93](#)

Standing lamps [101](#)
 – bulb replacement [202](#)
 Start/Stop button [62](#)
 Starting, refer to Starting engine [63](#)
 Starting assistance, refer to Jump-starting [209](#)
 Starting engine [63](#)
 Starting problems
 – jump-starting [209](#)
 – temperature [63](#)
 Start menu [18](#)
 Station, refer to Radio [152](#)
 Status lines in Control Center [23](#)
 Steering wheel [16](#)
 – adjustment [54](#)
 – adjustment, automatic [54](#)
 – heater [54](#)
 – individual button assignment [54](#)
 – memory [55](#)
 – with multi-function buttons [16](#)
 Steptronic, refer to Manual mode [70](#)
 Stopwatch
 – intermediate time [88](#)
 – starting and stopping [88](#)
 Storage, tires [193](#)
 Storage
 compartments [115](#), [116](#)
 Storage space, refer to Luggage compartment [42](#)
 Storing current position [143](#)
 Storing desired speeds, refer to Programmable cruise control [74](#)
 Storing destination per voice [142](#)
 Storing numbers, refer to Phone book [179](#)
 Storing programs, TV [163](#)
 Storing seat adjustment [55](#)

Storing sitting position, refer to Seat, mirror and steering wheel memory [55](#)
 Storing stations, radio [153](#)
 Storing vehicle, refer to the Caring for your vehicle brochure
 Straps, refer to Loading [124](#)
 "SUBTITLE" for DVD mode [169](#)
 Summer tires, refer to Wheels and tires [188](#)
 Sun blinds [113](#)
 Sun visors [113](#)
 Surface ice, refer to Ice warning [81](#)
 Switches, refer to Cockpit [10](#), [14](#)
 Switch for battery [207](#)
 Switching air conditioner mode on and off manually [105](#)
 Switching between calls [179](#)
 Switching navigation voice instructions on/off [141](#)
 Switching off engine [63](#)
 Switching off portable phone [178](#)
 Switching on
 – audio [149](#)
 – CD changer [160](#)
 – CD player [158](#)
 – DVD changer [166](#)
 – portable phone [178](#)
 – radio [152](#)
 – TV [163](#)
 "Switch. time 1", independent ventilation [111](#)
 "Switch. time 2", independent ventilation [111](#)
 Symbols,
 Control Center [19](#)

T
 Tachometer [81](#)
 Tail lamps, bulb replacement [203](#)
 Taking time, refer to Stopwatch [88](#)
 Tank contents, refer to Fuel tank capacity [217](#)
 Target cursor for navigation [135](#)
 Technical data [214](#)
 Technical modifications [5](#)
 Telephone [174](#)
 – accepting calls [16](#), [176](#)
 – dialing phone number [178](#)
 – entering lock code [178](#)
 – hands-free mode [177](#)
 – phone book [179](#)
 – redialing [180](#)
 – switching off [176](#), [178](#)
 – Top 8 [180](#)
 Television, refer to TV [163](#)
 Temperature [122](#)
 – automatic climate control [105](#)
 – changing unit of measure [89](#)
 Temperature display
 – ice warning [81](#)
 – interior temperature [105](#)
 – outside temperature [81](#)
 – setting units [89](#)
 Tempomat, refer to
 – Cruise control [75](#)
 – Programmable cruise control [73](#)
 The right tires [192](#)
 Thigh support adjustment [47](#)
 Third brake lamp
 – bulb replacement [203](#)
 – refer to Brake lamps [203](#)
 Three-point belt [51](#)
 Through loading system [118](#)
 Tightening torque, refer to Tightening lug bolts [205](#)
 Tilt alarm sensor
 – remote control [43](#)
 – switching off [43](#)

Tilt function, passenger-side mirror **56**
 "Time" **90**
 Time
 – display format **89**
 – setting **90**
 Time of arrival **87**
 Timer **87**
 "Tint" in TV mode **164**
 Tire pressure monitoring, refer to Flat Tire Monitor **95**
 Tire Quality Grading **190**
 Tires
 – age **190**
 – break-in **122**
 – changing **204**
 – condition **191**
 – damage **191**
 – flat tire **204**
 – inflation pressure **188**
 – replacing **192**
 – run-flat tires **192**
 – size **190**
 – storage **193**
 – tread **191**
 – tread depth indicators, refer to Tire tread/damage **191**
 – winter tires **193**
 Tires with emergency-running characteristics, refer to Run-flat tires **206**
 "TITLE" in DVD mode **167**
 Tone **148**
 – adjusting **149**
 – mid-range setting **151**
 "Tone" in audio mode **148, 150**
 Tools, refer to Onboard tool kit **201**
 "TOP 8" for telephone **180**
 Top 8 for telephone
 – dialing phone number **180**
 – on Control Display **180**
 – sorting entries **180**
 "TOP" in DVD mode **169**
 Torque **214**
 – lug bolts **205**

Tow bar **211**
 Tow fittings **210**
 Towing **210**
 Town/city
 – entering **133**
 – selecting **134**
 Tow rope **211**
 Tow sockets for tow fitting **210**
 Track, refer to Dimensions **215**
 Tracks, random sequence **158, 161**
 Transmission, automatic transmission with Steptronic **68**
 Transmission fault **70**
 Transmission interlock, manually releasing **70**
 Transmission lockout, refer to P Park **69**
 Transporting children safely **58**
 Transport securing device **125**
 Tray for pens **116**
 Tread depth, refer to Tire tread **191**
 Tread depth indicators in tires, refer to Tire tread **191**
 Treble, refer to Adjusting tone **149**
 "Treble" in audio mode **150**
 Trip odometer **81**
 Trunk, refer to Luggage compartment **42**
 Trunk lid, refer to Luggage compartment lid **39**
 Turning circle, refer to Dimensions **215**
 Turn signals **71**
 – bulb
 replacement **202, 203**
 – indicator lamp **13**
 – side-mounted, bulb replacement **202**

TV **163**
 – adjusting picture **164**
 – adjusting tone **149**
 – controls **148**
 – selecting **163**
 – selecting programs **163**
 – selecting standard **164**
 – storing programs **163**
 – switching on **149**
 – volume **149**
 "TV" during TV operation **163**
 "TV format" **164**
 Twist-and-press button, refer to Controller **17**

U

Undercoating, refer to the Caring for your vehicle brochure
 Uniform Tire Quality Grading **190**
 Unintentional alarm **43**
 Units of measure
 – average speed **89**
 – consumption **89**
 – distance **89**
 – temperature **89**
 Universal garage door control **112**
 Universal remote control **112**
 Unlocking
 – from inside **38**
 – hood **194**
 Unlocking and locking doors
 – from inside **38**
 – from outside **35**
 Unlocking without key, refer to Comfort Access **37**
 Used batteries, refer to Disposal **207**
 Using antifreeze **196**

V

Valve

- screw caps [206](#)
- stem [206](#)

Vanity mirror,
illuminated [54](#)

Vehicle

- adjustments [56](#)
- battery [207](#)
- break-in [122](#)
- care, refer to the Caring
for your vehicle brochure
- dimensions [215](#)
- identification number [195](#)
- loading [124](#)
- parking [64](#)
- storage, refer to the
Caring for your vehicle
brochure
- washing, refer to the
Caring for your vehicle
brochure
- weight [216](#)

Vehicle jack [204](#)

Vehicle position, refer to
Current position [143](#)

Ventilation [106](#)

- draft-free [106](#)
- while parked [110](#)

Video, refer to
DVD changer [165](#)

"Video", video
mode [148](#), [163](#)

"View" for
navigation [139](#), [140](#)

Viscosity [196](#)

Voice-command phone
book [179](#)

Voice command system [26](#)

Voice instructions

- muting [141](#)
- repeating [141](#)
- switching on/off [141](#)
- volume [141](#)

Volume [149](#)

- adjusting speed-
dependent [150](#)
- portable phone [177](#)
- voice command
system [27](#)
- voice instructions [141](#)

Volume, trunk [216](#)

Volume balance

- front/rear [150](#)
- right/left [150](#)

W

Warning and indicator
lamps [13](#)

Warnings, refer to
Check Control [83](#)

Warning triangle [209](#)

Warranty and Service
Guide Booklet for
Canadian models [198](#)

Washer fluid [73](#)

- reservoir, capacity [73](#)

Washer fluid reservoir, refer
to Windshield/headlamp
washer system [73](#)

Washer jets, refer to
Windshield washer
nozzles [72](#)

Washer system [73](#)

Washing the vehicle, refer
to the Caring for your
vehicle brochure

Waste container, refer to
Ashtray [117](#)

Waveband [152](#)

"WB"

- audio mode [148](#)
- in radio mode [155](#)

WB, waveband [155](#)

Weather Band [155](#)

Weights [216](#)

Wheel/tire combination [192](#)

Wheelbase, refer to
Dimensions [215](#)

Wheel bolt wrench [204](#)

- spare tire [204](#)
- Wheel-changing set [204](#)
- run-flat tires [206](#)
 - spare tire [205](#)

Wheel chock [204](#)

Wheels and tires [188](#)

Wheelslip control, refer to
DSC Dynamic Stability
Control [93](#)

Width, refer to
Dimensions [215](#)

Windows, convenience
operation [36](#), [38](#)

Windshield washer
- washer fluid [73](#)

Windshield washer fluid
tank [73](#)

- capacity, refer to Filling
capacities [217](#)

Windshield washer
nozzles [72](#)

Windshield washer
reservoir [73](#)

Windshield washing
system, wiper system [72](#)

Windshield wiper, refer to
Wiper system [72](#)

Windshield wiper blades
- care, refer to the Caring
for your vehicle brochure

- replacing [201](#)

Winter tires [193](#)

- changing [204](#)
- condition [191](#)
- run-flat tires [193](#)
- storage [193](#)

Wiper blade
replacement [73](#)

Wiper system [72](#)

"With highway" for
navigation [137](#)

"With map" for
navigation [135](#)

Without highway [137](#)

Wood decoration, refer to
the Caring for your vehicle
brochure

Wordmatch principle for
navigation [138](#)

Working in the engine
compartment [194](#)

Wrench, refer to Onboard
tool kit [201](#)

X

Xenon headlamps, bulb replacement [202](#)

Refueling

To ensure that you always have all the essential data at hand when refueling, we recommend that you fill in the following tables with the specifications and information that apply to your vehicle. Consult the index for individual specifications.

Fuel

Designation

Please enter your preferred fuel here.

Engine oil

Quality

The oil quantity between the two marks on the dipstick is approx. 1.65 US quarts/ 1.5 liter.

Tire inflation pressures

| | Summer tires Front | Rear | Winter tires Front | Rear |
|--|-----------------------|------|-----------------------|------|
|--|-----------------------|------|-----------------------|------|

Up to 4 persons

5 persons or 4 plus luggage

More about BMW

bmwusa.com



The Ultimate
Driving Machine

