

Owner's Manual
for Vehicle



The Ultimate
Driving Machine



X3 2.5i **Owner's Manual for Vehicle**

X3 3.0i

We are very glad that you have decided to purchase a BMW.

The more familiar you are with it, the more secure you will be on the roads. This is why we ask you:

Please read the information we have gathered for you in this Owner's Manual before you set off with your new BMW. You will receive important information on vehicle operation that enables you to make full use of the technical benefits of your BMW. You will also find information on maintenance that serves to retain the operating and road safety as well as the best possible value retention of your vehicle. You will find supplementary information in other brochures.

This Owner's Manual should be considered a permanent part of this vehicle. It should stay with the vehicle when sold to provide the next owner with important operating, safety and maintenance information.

We wish you an enjoyable driving experience.

BMW AG

© 2004 Bayerische Motoren Werke
Aktiengesellschaft
Munich, Germany
Reprinting, including excerpts,
only with the written consent of
BMW AG, Munich.
Order No. 01 41 0 158 448
US English VIII/04
Printed in Germany
Printed on environmentally friendly paper,
bleached without chlorine, suitable for recycling.

Contents

The fastest way to find specific topics is to use the index, refer to page 113.

Using this Owner's Manual

4 Notes

At a glance

10 Cockpit

Controls

16 Opening and closing

24 Adjustments

31 Transporting children safely

34 Driving

42 Everything under control

46 Technology for comfort, convenience and safety

53 Lamps

56 A congenial climate

62 Practical interior accessories

Driving tips

72 Things to remember when driving

Mobility

80 Refueling

82 Wheels and tires

88 Under the hood

93 Maintenance

95 Replacing components

103 Giving and receiving assistance

Reference

110 Technical data

113 Everything from A to Z

Notes

Using this Owner's Manual

We have made every effort to ensure that you are able to find what you need in this Owner's Manual as quickly as possible. The fastest way to find certain topics is by using the detailed index at the end. For a brief initial overview, please refer to the first chapter.

Should you sell your BMW some day, please remember to hand over the Owner's Manual as well; it is an important component of your vehicle.

Additional sources of information

If you have additional questions, your BMW Sports Activity Vehicle Center is always happy to advise you.

You can find information on BMW, e.g. technology, on the Internet at www.bmwusa.com.

Symbols used



Indicates precautions that must be followed precisely in order to avoid the possibility of personal injury and serious damage to the vehicle.



Indicates information that will assist you in gaining the optimum benefit from your vehicle and enable you to care more effectively for your vehicle.



Refers to measures that can be taken to help protect the environment.

◀ Marks the end of a specific item of information.

* Indicates special equipment, country-specific equipment and optional extras, as well as equipment and functions not yet available at the time of printing.



Vehicle Memory, Key Memory, refer to page 30. Identifies functions that can be specifically adapted for a particular key or vehicle. These adjustments can be performed by your BMW Sports Activity Vehicle Center.

Symbols on vehicle components



Indicates that you should consult the relevant section of this Owner's Manual for information on a particular part or assembly.

The individual vehicle

On purchasing your BMW, you have decided in favor of a model with individualized equipment and features. This Owner's Manual describes all models and equipment that BMW offers within the same group.

We hope you will understand that equipment and features are included that you might not have chosen for your vehicle. Sections describing options and special equipment are marked by asterisks * to assist you in identifying possible differences between the descriptions in this manual and your own vehicle's equipment.

If equipment in your BMW is not described in this Owner's Manual, please refer to the accompanying Supplementary Owner's Manuals.

Editorial notice

BMW pursues a policy of continuous, ongoing development that is conceived to ensure that our vehicles continue to embody the highest quality and safety standards combined with advanced, state-of-the-art technology. In isolated cases it is possible that the features described in this Owner's Manual could differ from those on your vehicle.

For your own safety

Maintenance and repair

 Advanced technology, e.g. the use of modern materials and high-performance electronics, requires specially adapted maintenance and repair methods. Therefore, only have corresponding work on your BMW carried out by a BMW Sports Activity Vehicle Center or a workshop that works according to BMW repair procedures with correspondingly trained personnel. If work is carried out improperly, there is a danger of consequential damage and the related safety risks. ◀

California Proposition 65 Warning

California law requires us to state the following warning:

 Engine exhaust and a wide variety of automobile components and parts, including components found in the interior furnishings in a vehicle, contain or emit chemicals known to the State of California to cause cancer and birth defects and reproductive harm. In addition, certain fluids contained in vehicles and certain products of component wear contain or emit chemicals known to the State of California to cause cancer and birth defects or other reproductive harm.

Battery posts, terminals and related accessories contain lead and lead compounds. Batteries also contain other chemicals known to the State of California to cause cancer. Wash your hands after handling. Used engine oil contains chemicals that have caused cancer in laboratory animals. Always protect your skin by washing thoroughly with soap and water. ◀

Parts and accessories

 For your own safety, use genuine parts and accessories approved by BMW.

When you purchase accessories tested and approved by BMW and Genuine BMW Parts, you simultaneously acquire the assurance that they have been thoroughly tested by BMW to ensure optimum performance when installed on your vehicle.

BMW warrants these parts to be free from defects in material and workmanship.

BMW will not accept any liability for damages resulting from installation of parts and accessories not approved by BMW.

BMW cannot test every product made by other manufacturers to verify if it can be used on a BMW safely and without risk to either the vehicle, its operation or its occupants.

Genuine BMW Parts, BMW Accessories and other products approved by BMW, together with professional advice on using these items, are available from all BMW Sports Activity Vehicle Centers.

Installation and operation of non-BMW approved accessories such as alarms, radios, amplifiers, radar detectors, wheels, suspension components, brake dust shields, telephones, including operation of any mobile phone from within the vehicle without using an externally mounted antenna, or transceiver equipment, for instance CBs, walkie-talkies, ham radios or similar accessories may cause extensive damage to the vehicle, compromise its safety, interfere with the vehicle's electrical system or affect the validity of the BMW Limited Warranty. Refer to your BMW Sports Activity Vehicle Center for additional information. ◀

 Maintenance, replacement, or repair of the emission control devices and systems may be performed by any automotive repair establishment or individual using any certified automotive part. ◀

Service and warranty

We recommend that you read this publication thoroughly.

Your BMW is covered by the following warranties:

- ▷ New Vehicle Limited Warranty
- ▷ Rust Perforation Limited Warranty
- ▷ Federal Emissions System Defect Warranty
- ▷ Federal Emissions Performance Warranty
- ▷ California Emission Control System Limited Warranty.

Detailed information about these warranties is listed in the Service and Warranty Information Booklet for US models or in the Warranty and Service Guide Booklet for Canadian models.

Reporting safety defects

The following only applies to vehicles owned and operated in the US.

If you believe that your vehicle has a defect which could cause a crash or could cause injury or death, you should immediately inform the National Highway Traffic Safety Administration NHTSA in addition to notifying BMW of North America, LLC, P.O. Box 1227, Westwood, New Jersey 07675-1227, telephone toll-free 1-800-831-1117.

If NHTSA receives similar complaints, it may open an investigation, and if it finds that a safety defect exists in a group of vehicles, it may order a recall and remedy campaign. However, NHTSA cannot become involved in individual problems between you, your dealer, or BMW of North America, LLC.

To contact NHTSA, you may either call the Auto Safety Hotline toll-free at 1-800-424-9393 or 366-0123 in Washington, D.C. area, or write to: NHTSA, U.S. Department of Transportation, Washington, D.C. 20590. You can also obtain other information about motor vehicle safety from the Hotline.



The background of the page is a blurred, blue-tinted photograph. In the foreground, the top of a dark-colored car is visible, including the hood and a license plate that reads "CIVIC". In the background, a group of people is gathered on what appears to be a beach, with some individuals looking towards the camera. The overall scene is out of focus, creating a sense of a lifestyle or outdoor setting.

At a glance

This overview of buttons, switches and displays is intended to familiarize you with your vehicle's operating environment. The section will also assist you in becoming acquainted with the control concepts and options available for operating the various systems.

Cockpit

Controls

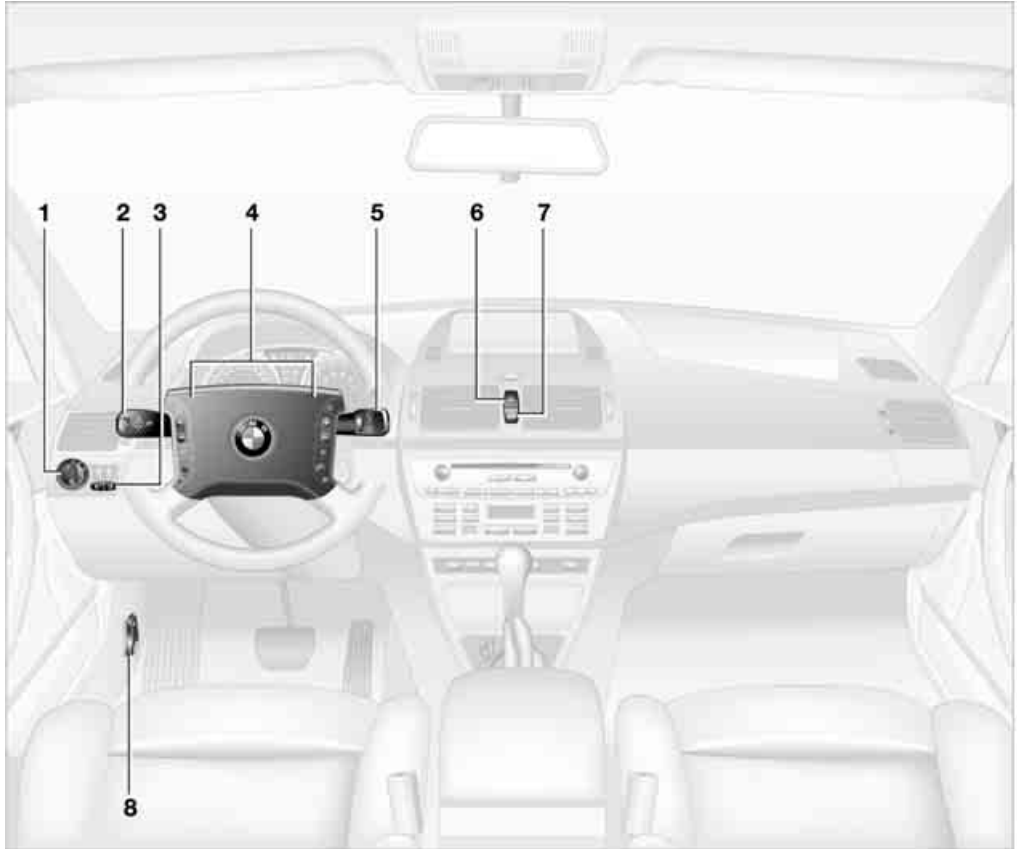

- | | |
|---|---|
| 1 Parking lamps/low beams 53 | 7 Central locking system 16 |
| 2 ▷ Turn signals 38 | 8 Unlocking the hood 88 |
| ▷ Roadside parking lamps 54 | |
| ▷ High beams 54 | |
| ▷ Headlamp flasher 38 | |
| ▷ Computer* 44 | |
| 3 Fog lamps* 54 | |
| 4 Horn | |
| 5 Washer/wiper system/rain sensor* 38 | |
| 6 Hazard warning flashers | |

Instrument cluster

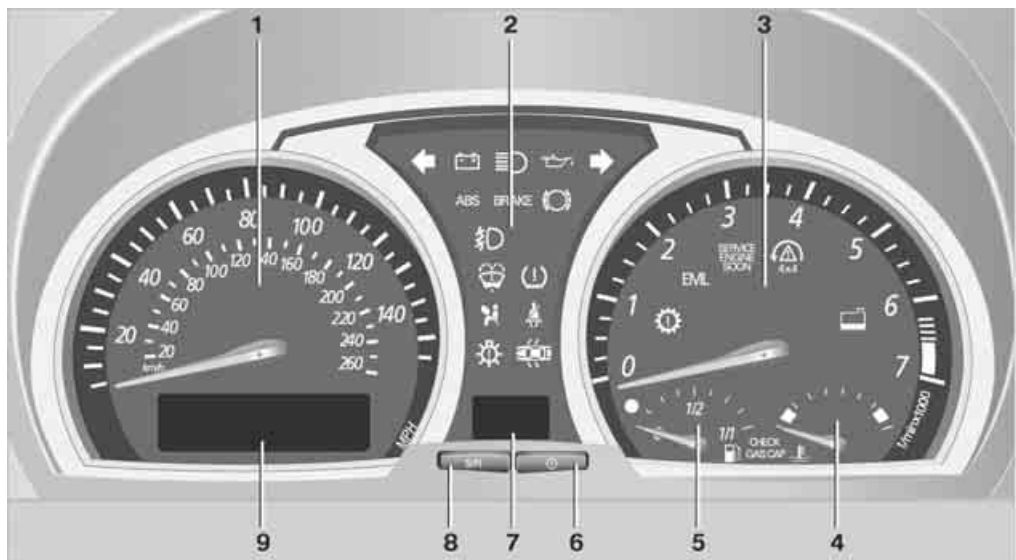

- 1 Speedometer
- 2 Indicator and warning lamps 11
- 3 Tachometer 42
 - Indicator and warning lamps 11
- 4 Coolant temperature gage 42
- 5 Fuel gage 42
- 6 Button for
 - ▶ Displaying the time 43
 - ▶ Service Interval Display 43
- 7 Selector lever and program display for automatic transmission 36
- 8 Button for
 - ▶ Resetting trip odometer 42
 - ▶ Setting the time 43
- 9 Display for
 - ▶ Trip odometer/odometer 42
 - ▶ Time 43
 - ▶ Service Interval 43
 - ▶ Computer 44

Indicator and warning lamps

Technology that monitors itself

The indicator and warning lamps identified by the ● are subjected to an operation check each time you switch on the engine. They each light up once for different periods of time.

When a malfunction occurs in a monitored system, the corresponding lamp will either fail to go out when the engine is started, or it will come on again during normal driving. Detailed information is provided on the specified pages.



















Please fasten safety belt ● 27







Airbags ● 51



Brake system ●
 With handbrake released 49, 92
 With handbrake engaged 35
 With other warning lamps 49

	Brake warning lamp for Canadian models
	Driving stability control systems/ ABS Antilock Brake System ● 49
	ABS Antilock Brake System/chassis control system for Canadian models
	Brake pads ● 92
	DSC Dynamic Stability Control/ xDrive ● 47, 49
	Flat Tire Monitor ● 49
	Automatic transmission ● 36
	Engine oil ● 90
	Service Engine Soon ● 94
	Service Engine Soon warning lamp for Canadian models
	Check Gas Cap* ● 80
	Engine electronics ● 34
	Battery charge current ● 101
	Topping off coolant 91
	Topping off washer fluid 90
	Lamp defective 53
	Turn signals 38

	Front fog lamps 54
	Headlamp flasher 38 High beams 54
	Cruise control 40
	Indicates from ignition key in position 2 when a door or the tailgate is opened.

Colors

The indicator and warning lamps can light up in different colors and combinations.

The following section explains the significance of the individual colors as well as how you should respond when they appear.

- ▷ red:
 - Stop the vehicle immediately
 - or
 - an important reminder
- ▷ yellow:
 - Have the system inspected as soon as possible
 - or
 - For your information
- ▷ green:
 - For your information
- ▷ blue:
 - For your information

Buttons on steering wheel*

The buttons integrated into the steering wheel are provided so that you can operate a number of accessories quickly and without being distracted from traffic conditions. You may operate:

- ▷ Selected audio source functions
- ▷ Recirculated-air mode/steering wheel heater

- ▷ Cruise control
- ▷ Selected telephone functions
- ▷ Voice command system

 In order to operate a system, the corresponding system must be switched on. ◀

Telephone*/voice command system*



Press briefly:
Accept incoming call, start dialing, terminate call.

Extended pressure:
Activate/deactivate voice command system

Telephone*/audio sources*



Display/hide phonebook. Display the entries consecutively with the buttons for fast forward/reverse

Fast forward/reverse



- ▷ Radio
Press briefly: next station
- ▷ CD
Press briefly: skip track
Extended pressure: fast forward/reverse
- ▷ Phone
Browse through list of names

Volume



On the sports steering-wheel* the buttons +/- for volume are located on the left-hand side of the steering wheel.

Cruise control*



Cruise control: resume



Cruise control: storing and accelerating + as well as braking and storing -

On the sports steering-wheel* the buttons +/- for the cruise control are located on the right-hand side of the steering wheel.



Cruise control: activating/interrupting/deactivating

Recirculated-air mode/steering wheel heater*

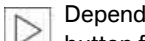

Depending on the equipment, there is a button for the recirculated-air mode or steering wheel heater. ◀



Switching recirculated-air mode on and off



Steering wheel heater: switching on/off, refer to page 28.





Controls

This chapter is intended to provide you with information for complete control of your vehicle. Its extensive array of features and accessories, both for driving and for your own safety, comfort and convenience, are described here.

Opening and closing

Key set

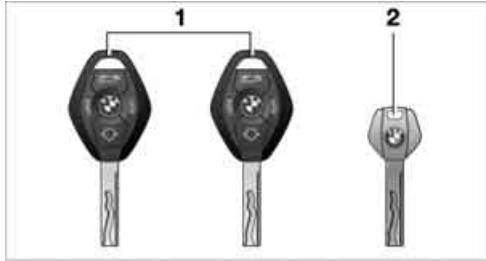

1 Master keys with remote control

Every master key with remote control contains an extended-life battery as a power supply, which is charged automatically in the ignition lock as you drive. You should use each master key at least twice a year in order to maintain the charge condition. Depending on which master key is detected by the vehicle during unlocking, different settings in the vehicle are requested and executed, refer to Vehicle and Key Memory on page 30.

2 Spare key

For storage in a safe place, such as in your wallet.

This key does not fit in the lock of the glove compartment. This is an advantage, e.g. when valet parking at a hotel. The key is not intended for constant use.

Replacement keys

Replacement and additional keys are available from your BMW Sport Activity Vehicle Center.

Central locking system

The concept

The central locking system is ready for operation whenever the driver's door is closed. The system engages or releases the locks on the

- ▷ doors
- ▷ tailgate
- ▷ fuel filler door

The central locking system can be operated from the outside

- ▷ via the remote control
- ▷ via the driver's door lock

and from inside via the button for the central locking system.

When the system is locked from inside, the fuel filler door remains unlocked, refer to page 18.

The anti-theft system is automatically activated whenever you activate the central locking system from outside the vehicle. This prevents the doors from being unlocked via the lock buttons or door handles. The alarm system is also armed or disarmed.

In the event of a serious accident, the central locking system unlocks automatically. In addition, the hazard warning flashers and interior lamps switch on.

Opening and closing: from outside

Using the remote control

When you engage/release the vehicle locks, you also activate/deactivate the anti-theft system, arm/disarm the alarm system, and switch the interior lamps on/off.



You can set an acoustic signal to remind you if the ignition key is still in the ignition lock after you open the driver's door. ◀

 Protect the remote control against unauthorized use by handing over only the spare key, for example when using hotel valet parking. ◀

For additional details on the alarm system, refer to page 22.

 Because any persons or animals left unattended in a parked vehicle could lock the doors from the inside, you should always keep the remote control with you; this precaution ensures that you will remain able to unlock the vehicle from the outside at all times. ◀

Unlocking

Press the  button.

Press the button once to unlock the driver's door only; press a second time to unlock all remaining doors as well as the tailgate and the fuel filler door.

Convenience opening mode

Press and hold the  button. The windows and the panorama glass sunroof open.

 If you desire, you can have this special feature activated/deactivated on a vehicle-specific basis. ◀

Locking and securing

Press the  LOCK button.

 If you desire, the vehicle locks automatically if no door or lid is opened after unlocking. You may have this function set on a vehicle-specific basis if you wish. ◀

As confirmation for the fact that the vehicle is properly locked, the hazard warning flashers light up.

 If you wish, you can have this special feature deactivated on vehicles without an alarm system. ◀

Switching off tilt alarm sensor* and interior motion sensor*

Press the  LOCK button again directly after locking.

For details, refer to page 23.

Switching on interior lamps

Press the  LOCK button if the vehicle is locked. You can also use this function to locate your vehicle in parking garages etc.

Panic mode*

By pressing and holding the  button for more than approx. two seconds, you can trigger the alarm system* in response to any impending danger.

To switch off the alarm: press any of the buttons.

Unlocking tailgate

Press the  button.

The tailgate will open slightly, regardless of whether it was previously locked or unlocked.

 Before and after a trip, ensure that the tailgate has not been opened unintentionally.

A previously locked tailgate is also locked again after closing. ◀

 If you desire, the tailgate can only be opened using the remote control if the vehicle is unlocked. This can be adjusted. ◀

Malfunctions

The remote control may malfunction due to local radio waves.

Should the remote control fail to operate owing to interference of this kind, unlock and lock the vehicle via the door lock using the master key.

If it is no longer possible to lock the vehicle via the remote control, the battery is discharged.

Use this remote control during an extended drive; this will recharge the battery, refer to page 16.

For US owners only

The transmitter and receiver units comply with part 15 of the FCC/Federal Communications Commission regulations. Operation is governed by the following:

FCC ID: LX8EWS

LX8FZVS

LX8FZVE

Compliance statement:

This device complies with part 15 of the FCC Rules. Operation is subject to the following two conditions:

- ▷ This device may not cause harmful interference.
- and
- ▷ This device must accept any interference received, including interference that may cause undesired operation.

 Any unauthorized modifications or changes to these devices could void the user's authority to operate the equipment. ◀

Using door lock



One turn of the key in the driver's door lock unlocks the driver's door only.

Turning the key a second time unlocks all of the remaining doors, the tailgate and the fuel filler door.

As confirmation for the fact that the vehicle is properly locked, the hazard warning flashers light up.

 If you wish, you can have this special feature deactivated on vehicles without an alarm system. ◀

Convenience operation

You also have the option of operating the windows and the panorama glass sunroof from the driver's door lock.

- ▷ To open:

With the door closed, turn the key to the Unlock position and hold it there.

- ▷ To close:

With the door closed, turn the key to the Lock position and hold it.

 Watch during the closing process to be sure that no one is injured. Releasing the key stops the operation. ◀

Manual operation

If an electrical malfunction occurs, you can unlock or lock the driver's door with the key in the end positions of the door lock.

Opening and closing: from inside



You can use this button to operate the central locking system when the front doors are closed. With this button, only the doors and the tailgate are unlocked or locked. The anti-theft system is not activated.

 If only the driver's door was unlocked from the outside and you press the button, then, with the driver's door still open, the passenger-side door, the tailgate and the fuel filler door will also unlock.

If the driver's door is closed, it will be locked. ◀

 The central locking system locks automatically after driving off. This can be adjusted to be vehicle-specific or key-specific. ◀

Unlocking and opening doors

1. Press button for central locking system.
2. Pull the respective door handle above the armrest.

or

individually pull on the door handle of each door twice to unlock and open.

Engaging locks

- ▷ Press button for central locking system.

or

- ▷ Press down the lock buttons of the doors. To prevent you from being locked out, the opened driver's door cannot be locked using the lock button.

⚠ Because any persons or animals left unattended in a parked vehicle could lock the doors from the inside, you should always keep the key with you; this precaution ensures that you will remain able to unlock the vehicle from the outside at all times. ◀

Tailgate

Opening from outside

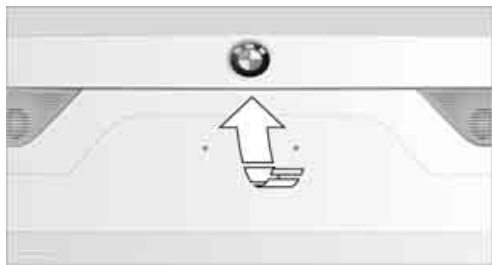

Press the button in the handle strip. The tailgate is unlocked and opens somewhat.

▷ During opening, the tailgate pivots back and up. Ensure that adequate clearance is available before opening. ◀

When the tailgate is open, the cargo area and interior are lit up.

Manual unlocking

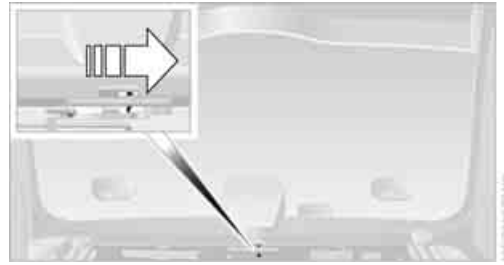

In the event of an electrical malfunction:

1. Fold up the floor cover in the cargo area.
2. Release the jack from the bracket.
3. Press the lever behind the cover to the side, refer to arrow.

The tailgate is locked again as soon as you close it.

Closing

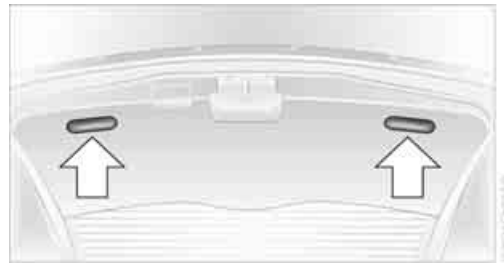

The handle recesses on the interior trim of the tailgate make it easier to pull down.

⚠ To avoid injuries, be sure that the travel path of the tailgate is clear when it is closed, as with all closing procedures. ◀

Windows

Opening and closing windows



As of ignition key position 1:

- ▷ Press the switch up to the resistance point:
The window continues to move as long as you continue to press the switch.
- ▷ Briefly press the switch beyond the resistance point:
The window moves downward automatically. Briefly press the switch again to stop the opening motion.

You can close the windows in the same manner by pulling the switch.

After switching off ignition

You can operate the power windows for up to 15 minutes as long as neither of the front doors has been opened.

 When leaving the vehicle, always remove the key and close the doors, as otherwise children could operate the windows and injure themselves. ◀

For convenience operation using the door lock, refer to page 18.

Anti-trapping mechanism

If the closing force rises beyond a predefined threshold during closing, the system will immediately stop moving the window prior to lowering it slightly.

 Despite the anti-trapping mechanism you should always inspect the window's travel path prior to closing it, as the safety system might fail to detect certain kinds of obstructions, such as very thin objects, and the window

would continue closing.

You can disable the anti-trapping mechanism by pressing the switch beyond the resistance point and holding it. ◀

Following interruptions in electrical power supply

After disconnecting the battery, the anti-trapping mechanism must be reinitialized. To do this, open and close the windows once and continue pull the switch for longer than 2 seconds after closing.

Safety switch



With the safety switch, you can prevent the rear windows from being opened or closed via the switches in the rear passenger area, by children, for example. The indicator lamp lights up when this safety feature is activated.

 Always press the safety switch when children ride in the rear, as otherwise unchecked closing of the windows could lead to injuries. ◀

 You can deactivate the function again as of ignition key position 1. ◀

Accessories in window area

After installing any accessory – such as a clamp-on antenna for a portable phone – within the window's travel range, you will need to have the system reinitialized for use under the new conditions. Please contact your BMW Sports Activity Vehicle Center.

Panorama glass sunroof*

 When leaving the vehicle, always remove the key and close the doors, as otherwise children could operate the sunroof and injure themselves. ◀

The panorama glass sunroof is operational from ignition key position 1.

After the ignition has been switched off: You can operate the panorama glass sunroof for up to 1 minute as long as neither of the doors has been opened.

Raising, opening, closing

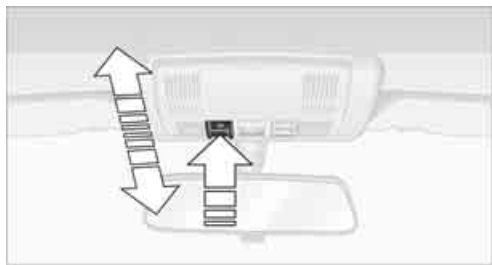

Press the switch or slide it in the desired direction up to the resistance point.

Release the switch to stop the motion.

The sliding visor is opened slightly when the panorama glass sunroof is raised.

The panorama glass sunroof can be opened or closed independently with the sliding visor open.

Ventilation setting

The panorama glass sunroof is raised and the sliding visor is opened slightly: Briefly press the switch twice consecutively.

Automatic opening and closing

Briefly press the switch past the resistance point and then release it.

Briefly pressing the switch again stops the motion.

Opening and closing panorama glass sunroof and sliding visor together

Briefly press the switch beyond the resistance point twice consecutively.

Briefly pressing the switch again stops the motion.

Comfort position

Each time the panorama glass sunroof is completely opened or closed, it stops in the comfort position. If desired, continue the motion following this with the switch.

In the comfort position the wind noise in the interior is reduced.

Anti-trapping mechanism

If the panorama glass sunroof or sliding visor encounter resistance when closing from roughly one third of the sunroof opening or when closing from the raised position, the closing action is interrupted and the panorama glass sunroof and sliding visor reopen a little.

 Despite the anti-trapping mechanism inspect the sunroof's travel path prior to closing it, as the safety system might fail to detect certain kinds of obstructions, such as very thin objects, and the sunroof would continue closing.

The anti-trapping mechanism for closing the panorama glass sunroof is deactivated if the switch is pressed beyond the resistance point and held there. The closing action is interrupted when you release the switch. ◀

Following interruptions in electrical power supply

Following interruptions in electrical power, for instance, when the battery is disconnected, it is possible that the panorama glass sunroof will extend to its tilt-up position, but fail to respond to other commands. The system must be initialized. BMW recommends having this work carried out by your BMW Sports Activity Vehicle Center.

Manual operation

In the event of an electrical malfunction, you can operate the panorama glass sunroof manually.

1. Pull off the cover firmly downward.

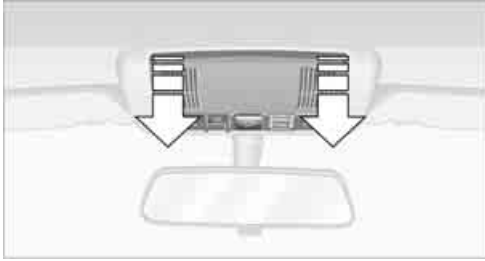

2. Insert the Allen wrench from the compartment beneath the cargo area floor, refer to page 99, into the proper opening and turn the panorama glass sunroof in the desired direction. Direction of rotation for closing, refer to arrow.

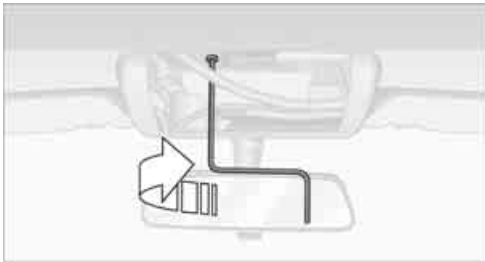

Alarm system*

The concept

The vehicle alarm system responds:

- ▷ When a door, the hood, or the tailgate is opened.
- ▷ To movements inside the vehicle: interior motion sensor, refer to Tilt alarm sensor and interior motion sensor.
- ▷ To changes in the vehicle tilt angle such as occur during attempts to steal the wheels or tow the vehicle.
- ▷ To interruptions in battery voltage.

The system responds to unauthorized vehicle entry and attempted theft by simultaneously activating:

- ▷ The acoustic alarm for approx. 30 seconds.
- ▷ The hazard warning flashers for approx. 5 minutes.
- ▷ The high beams, which flash on and off in the same rhythm.

Arming and disarming alarm system

When you lock or unlock the vehicle, either with the remote control or at the door lock, the alarm system is armed or disarmed at the same time.

If the alarm system has been properly armed, the hazard warning flashers light up once.



You can have different acknowledgment signals set to confirm arming and disarming. ◀

You can also open the tailgate with the system armed using the  button on the remote control, refer to page 17. When you close the tailgate, the system is rearmed.

Switching off alarm

- ▷ Unlock the vehicle using the remote control, refer to page 17.
- or
- ▷ Turn the ignition key to position 1.

Indicator lamp displays



- ▷ The indicator lamp below the interior rearview mirror flashes continuously: the system is armed.

- ▷ The indicator lamp flashes when the vehicle is locked: door(s) or tailgate are not completely closed. Even if you do not close the alerted area, the system begins to monitor the remaining areas, and the indicator lamp flashes continuously after 10 seconds. However, the interior motion sensor is not activated.
- ▷ The indicator lamp goes out when the vehicle is unlocked: no manipulation or attempted intrusions have been detected in the period since the system was armed.
- ▷ The indicator lamp flashes for 10 seconds after the vehicle is unlocked: an attempted entry has been detected in the period since the system was armed.

Following triggering of an alarm, the indicator lamp will flash continuously.

Tilt alarm sensor and interior motion sensor

Tilt alarm sensor

The tilt of the vehicle is monitored. The alarm system reacts, e.g. in case of an attempted wheel theft or towing.

Interior motion sensor

In order for the interior motion sensor to function properly, the windows and panorama glass sunroof must be completely closed.

Avoiding unintentional alarms

The tilt alarm sensor and interior motion sensor may be switched off at the same time. This prevents unintentional alarms, e.g. in the following situations:

- ▷ In stacking garages
- ▷ When transporting on car-carrying trains
- ▷ When animals are to remain in the vehicle

Switching off tilt alarm sensor and interior motion sensor

Press the  LOCK button on the remote control again directly after locking.

The indicator lamp lights up briefly and then flashes continuously. The tilt alarm sensor and the interior motion sensor are switched off until the next time the vehicle is unlocked and subsequently locked again.



If you wish, the tilt alarm sensor and interior motion sensor are permanently switched off. You can have this set at your BMW Sports Activity Vehicle Center. ◀



If you interrupt the convenience closing of the windows and panorama glass sunroof within the first 10 seconds and then reinitiate the action, this will unintentionally switch off the tilt alarm sensor and interior motion sensor. If this has occurred, the system must be disarmed and then rearmed. ◀

Adjustments

Sitting safely

The ideal sitting position can make a vital contribution to relaxed driving that is as fatigue-free as possible. The sitting position plays an important role together with the safety belts, head restraints and airbags in providing occupants with maximum levels of passive safety in an accident. Therefore, observe the following instructions, as otherwise the protective function of the safety systems may be impaired.

For additional information on transporting children safely, refer to page 31.

Airbags

 Always maintain an adequate distance between yourself and the airbags. Always hold the steering wheel by its rim with hands at the 9 o'clock and 3 o'clock positions, to minimize the risk of injuries to your hands and arms in the event of airbag deployment.

No one and nothing is to come between the airbags and the seat occupant.

Do not use the cover of the front airbag on the front passenger side as a storage area. Make sure that the front passenger is correctly seated and does not place feet or legs against the instrument panel, as otherwise leg injuries can result if the front airbag is triggered. Never let an occupant's head rest near or on a side airbag because the inflating airbag could cause a serious or fatal injury. ◀

Even if you adhere to all the instructions, injuries resulting from contact with airbags cannot be fully excluded, depending on the circumstances. The ignition and inflation noise may provoke a mild – usually temporary – hearing loss in extremely sensitive individuals.

For airbag locations and additional information on airbags, refer to page 31.

Safety belts

Make sure the safety belts are worn in all occupied seats every time you drive. Although airbags enhance safety by providing added protection, they are not a substitute for safety belts.

Your vehicle has five seats that are all equipped with a safety belt.

 Occupants should sit upright and be properly restrained at all times: infants and small children in appropriate child-restraint systems; larger children and adults using the safety belts.

Never allow more than one person to wear a single safety belt. Infants and children must not ride on a lap.

Expectant mothers should always wear their safety belts, taking care to position the lap belt against the lower hips, where it will not exert pressure against the abdominal area. The safety belt must not rest against the neck, nor be wedged in any way or permitted to rub against sharp edges. Avoid twisting the belt while routing it snugly across the hips and shoulder, as close to the body as possible, without resting against hard or fragile objects. Otherwise, in the event of a frontal impact, a loose lap belt could slide over your hips, leading to abdominal injury. Avoid wearing clothing that prevents the belt from fitting properly and pull the shoulder belt upward periodically to readjust the tension across your lap in order to avoid a reduction in the restraining action of the safety belt. ◀

If the middle safety belt in the rear is used, then the wider backrest must be secured, refer to page 67, otherwise, the safety belt cannot exert any restraining action.

For fastening safety belts, refer to page 27.

Seats

Note before adjusting

 Never try to adjust your seat while operating the vehicle. The seat could respond with unexpected movement, and the ensuing loss of vehicle control could lead to an accident. On the passenger side as well, do not recline the backrest too far while the vehicle is being driven, as otherwise there is a danger of sliding under the safety belt during an accident, eliminating the protection normally provided by the belt. ◀

Please observe the information on using safety belts provided on page 27 and the information on the head restraints on page 25.

Seat adjustment

 To ensure that the safety systems continue to provide optimized protection, please observe the adjustment instructions above. ◀

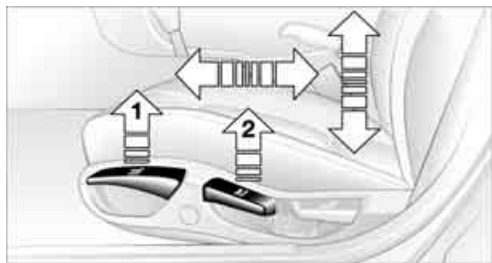

1 Longitudinal direction

Pull the lever and slide the seat into the desired position. After you release the lever, move the seat forward or backward slightly so that it engages fully.

2 Height

Pull the lever and apply weight to or remove weight from the seat as required.

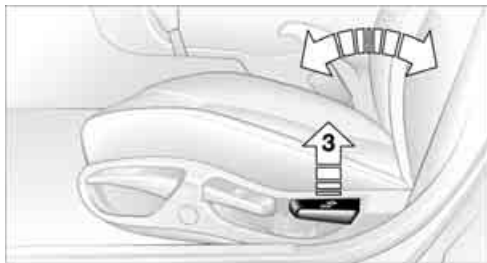

3 Backrest

Pull the lever and apply weight to or remove weight from the backrest as required.

Adjusting sports seat*

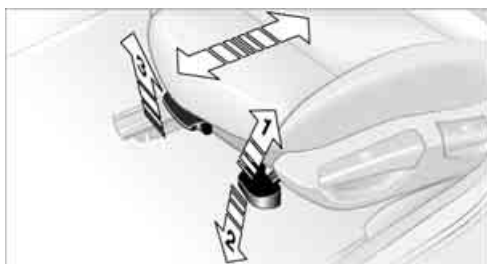

You can also adjust the tilt and the thigh support:

1 Upward tilt

Pull the lever as many times as required to set the desired tilt.

2 Downward tilt

Press the lever as many times as required to set the desired tilt.

3 Thigh support

Pull the lever and move the thigh support in a longitudinal direction.

Head restraints

 Head restraints reduce the risk of injury to cervical vertebrae when accidents occur. Adjust the head restraints so that their middles are approximately at ear height. ◀

Adjustments

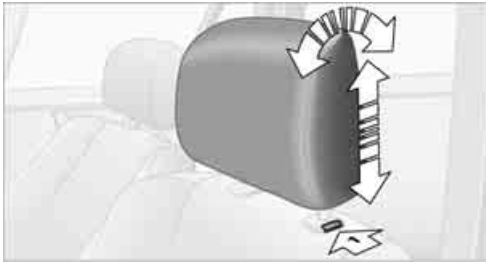

Height adjustment:

- ▷ To raise: pull upward.
- ▷ To lower: press button, arrow 1, and slide head restraint downward.

Front head restraint tilt angle: adjust by tilting.

Removing front head restraint

1. Pull the head restraint upward to the stop.
2. Press button, arrow 1, and pull head restraint all the way out.

Installing front head restraint

1. Press button, arrow 1, and slide the head restraint into its sockets.
2. Adjust the head restraint.

Power seat*

 To ensure that the safety systems continue to provide optimal protection, please observe the adjustment instructions on page 24. ◀

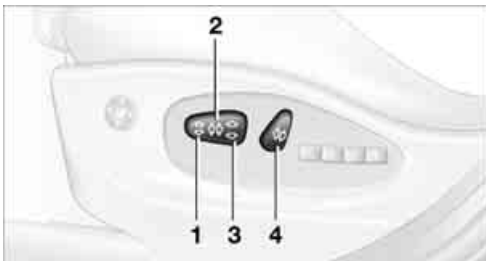

- 1 Tilt
- 2 Longitudinal direction
- 3 Height
- 4 Backrest

Setting the head restraint manually, refer to above paragraph.

Lumbar support*



You can also adjust the contours of the backrest to obtain additional support in the lumbar region.

The upper hips and spinal column receive supplementary support to help you maintain a relaxed, upright sitting position.

- ▷ To increase or decrease curvature: press switch forward or back.
- ▷ To move curvature up or down: press switch up or down.

Seat and mirror memory*

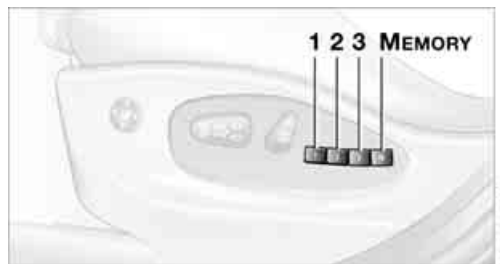

You can store and select three different adjustment settings for the driver's seat and exterior mirrors.

The adjustment of the lumbar support is not stored in the memory.

Storing

1. Turn the ignition key to position 1 or 2.
2. Set the desired seat and exterior mirror position.

3. Press the **MEMORY** button:
The indicator lamp in the button lights up.
4. Press the desired memory button **1, 2 or 3**:
The indicator lamp goes out.

Requesting a stored setting

 Do not request a position from the memory while the vehicle is moving, as otherwise there is a risk of accident from unexpected seat movement. ◀

Convenience mode

1. Open the driver's door after unlocking or turn the ignition key to position 1.
2. Briefly press the desired memory button **1, 2 or 3**.
The system immediately cancels the adjustment procedure when you press one of the seat adjustment buttons or use one of the memory buttons.

Safety feature

1. Close the driver's door and turn the ignition key to position 0 or 2.
2. Press the desired memory button **1, 2 or 3** and maintain pressure until the adjustment process has been completed.

 If you press the **MEMORY** button accidentally:
Press the button a second time – the indicator lamp goes out. ◀

 You can have your vehicle programmed to automatically recall your own individual adjustment settings for the seat and exterior mirror position whenever you use your personal remote control to unlock the vehicle. ◀

 If you make use of this adjustment, be sure that the footwell behind the driver's seat is unobstructed before unlocking the vehicle. If you fail to do so, any persons, animals or objects behind the seat could be injured or damaged by a rearward movement of the seat. ◀

Heated seats*



The seat cushion and backrest can be heated when the ignition key is in position 2.

To request different temperature levels: press the button repeatedly.

To switch off from a higher heat setting: press the button and hold it slightly longer.

Safety belts

 To ensure that the safety systems continue to provide optimal protection, please follow the instructions on page 24. ◀

Make sure the safety belts are worn in all occupied seats every time you drive. Although airbags enhance safety by providing added protection, they are not a substitute for safety belts.



Fastening

Make sure you hear the latch plate engage in the belt buckle.

Releasing

1. Press the red button in the belt buckle.
2. Hold the belt firmly.

3. Guide the belt back into its reel.

The upper shoulder strap's anchorage point will be in the correct position for seat occupants of every build if the seat is correctly adjusted, refer to page 24.

The two rear safety belt buckles integrated into the rear seat are for passengers sitting on the left and right. The belt buckle embossed with the word CENTER is intended exclusively for use by passengers riding in the center position. ◀

Safety belt reminder for front seats



The indicator lamp flashes or lights up. In addition, a signal sounds. Please make sure that the safety belts are

being worn correctly.

The safety belt reminder is activated if the safety belt on the driver's side has not yet been fastened.

At speeds greater than 5 mph/8 km/h, the safety belt reminder is also activated if the passenger side safety belt has not yet been fastened, if heavy objects are placed on the passenger's seat, or if the front passenger's safety belt is released.

Damage to safety belts



If the safety belts are damaged or stretched in an accident: have the entire belt system, including the tensioning mechanisms, replaced at your BMW Sports Activity Vehicle Center or at a workshop that works according to BMW repair procedures with correspondingly trained personnel. Have the belt anchorage points inspected for damage at the same time. Failure to observe this precaution may prevent the safety belts from effectively providing optimal protection when needed. If a child-restraint system was in the vehicle during an accident, consult the manufacturer's instructions regarding replacement. ◀

Steering wheel

Adjustments



Do not adjust the steering wheel while the vehicle is moving. There is a risk of accident from unexpected movement. ◀

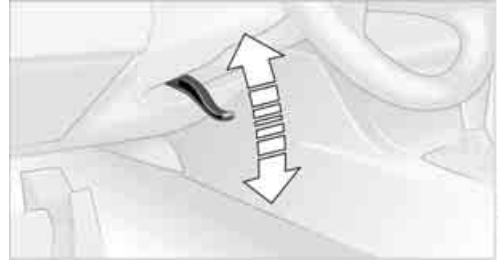

1. Fold the clamping lever downward.
2. Adapt the steering wheel in the longitudinal direction and height of the seat position.
3. Fold the clamping lever back up.

Steering wheel heater*

The button for steering wheel heater is located on the steering wheel, refer to page 12.



Steering wheel heater: switching on/off

The steering wheel heater operates as of ignition key position 2.

Press the button to activate or deactivate this system.

The indicator lamp within the button lights up when the steering wheel heater is in operation.

Mirrors

Exterior mirrors



The mirror on the passenger side features a lens with a more convex surface than the mirror installed on the driver's side. When estimating the distance between yourself and other traffic, bear in mind that the objects reflected in the mirror are closer than they appear. This means that estimations of the

distance to following traffic should not be regarded as precise. ◀

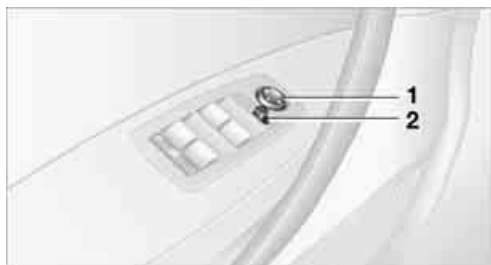

- 1 Adjustments
- 2 Switching over to the other mirror or to the automatic parking function*

Storing the mirror positions, refer to Seat and mirror memory on page 26.

 To prevent the exterior mirrors on this vehicle from being damaged, always fold them in by hand before entering an automatic car wash. ◀

Manual adjustments

You can also adjust the mirrors manually if need be: by pressing the edges of the mirror glass.

Automatic heating

When the outside temperature falls below a specified temperature, both outside mirrors are automatically heated whenever the engine is running or the ignition is switched on.

Tilting down passenger's mirror, automatic parking function*



Activating

1. Select the driver's exterior mirror with switch 1.
2. When you shift into reverse or move the selector-lever into position R, the exterior mirror glass on the front passenger side tilts downward slightly. This allows the driver to see the area immediately adjacent to the vehicle – such as a curb – when parking, etc.



You can have the angle of downward tilt set to depend on the key used. ◀

Deactivating

Select the front passenger's exterior mirror with switch 1.

Interior rearview mirror



To reduce the dazzle effect of following vehicles at night, turn the knob.

Vehicle Memory, Key Memory

How the system functions

You have probably frequently wished that you could configure individual functions of your vehicle to reflect your own personal requirements. In developing your vehicle, BMW has incorporated a number of options for personal adjustment. You can have these programmed at your BMW Sports Activity Vehicle Center.

There are vehicle-related and person-related adjustments: Vehicle Memory and Key Memory. You can configure up to four different basic adjustments for four different persons. The only requirement is that each person uses his or her own master key with remote control.

When your vehicle is unlocked with the remote control, the vehicle recognizes the individual user by means of a data exchange with the key, and makes adjustments accordingly.

In order for you to distinguish between the master keys with remote control, color-coded decals are supplied together with the keys.

What the system can do

Your BMW Sports Activity Vehicle Center can provide you with details on the capabilities of the Vehicle Memory and Key Memory systems.



You will see this symbol throughout the Owner's Manual. It is to remind you at appropriate places of the settings that are available to you. ◀



Following configuration of memory functions, vehicle operation may differ from the description in the Owner's Manual. Should you want to sell your BMW some day, please remember to have the memory functions reset to the factory default settings. ◀

Examples of Vehicle Memory functions

- ▷ Different acknowledgment signals to confirm locking/unlocking of the vehicle, refer to page 16.
- ▷ Activating/deactivating function for pathway lighting, refer to page 53.
- ▷ Activating/deactivating daytime driving lamps, refer to page 53.
- ▷ Setting measurement units for displays in the instrument cluster for time, outside temperature, distance driven and fuel consumption, refer to page 44.
- ▷ Active PDC Park Distance Control is indicated by an acoustic sound signal when reverse gear or selector lever position R is engaged, refer to page 46.
- ▷ The rear window defroster switches on automatically, refer to page 57.
- ▷ Different acknowledgment signals to confirm arming/disarming the alarm system, refer to page 22.
- ▷ After an ice warning has been issued, the computer display returns to the previous adjustment, refer to page 44.
- ▷ Acoustic warning if the ignition key remains in the ignition lock after the driver's door has been opened, refer to page 19.

Examples of Key Memory functions

- ▷ When unlocking, first unlock the driver's door, then the entire vehicle, refer to page 17.
- ▷ Locking the vehicle after moving off, refer to page 18.
- ▷ Automatic adjustment of the driver's seat and exterior mirror position for each person when unlocking the vehicle, refer to page 27.
- ▷ Angle of downward tilt of mirror on passenger side, refer to page 29.

Transporting children safely

The right place for children

Children always in the rear

Accident research shows that the safest place for children in a vehicle is in the rear seat.

Older children should be tightly secured with a safety belt, after they have outgrown a booster seat that is appropriate for their age, height and weight.

 If your vehicle is equipped with rear side airbags, do not allow children to lean toward the door trim, as serious injuries could occur if the side airbags are deployed and children are too close to the airbags. ◀

Deactivating side airbags in the rear

Labels in the rear door opening should indicate the status of your rear seat side airbags. If you are uncertain of their status, or wish to have the airbags activated or deactivated, please contact your BMW Sports Activity Vehicle Center.

Child-restraint system in rear

 Children under 13 years of age and children less than 5 ft/150 cm tall should always ride in the rear and the restraint systems should be properly secured. ◀

Younger children should be secured in an appropriate child restraint system that has been first properly secured to the vehicle.

All rear seating positions in your vehicle meet the recommendations of SAE J1819, an industry-recommended practice for securing child-restraint systems in motor vehicles.

Exception for the front passenger seat

 Should it become necessary to use a child-restraint system on the front passenger seat, the airbags on the passenger side must be deactivated. The passenger airbag indicator lamp above the interior rearview mirror must light up continuously. Otherwise, the front passenger airbags remain active and there is

considerable risk of injury to children if the airbags are triggered, even with a child-restraint system. In this case, children should be seated in the rear and the system should be checked at your BMW Sport Activity Vehicle Center. ◀

 Never install a rearward-facing child-restraint system in the front passenger seat of this vehicle if the passenger airbag is not deactivated. If you do so, the child could be severely injured when the airbag is triggered. Your vehicle is equipped with an airbag supplemental restraint system for the front passenger. Because the backrest on any rearward-facing child-restraint system – of the kind designed for infants under 1 year and 20 lbs./9 kg – would be within the airbag's deployment range, you should never mount such a system in the front passenger seat, since the impact of the airbag against the child restraint's backrest could lead to serious or fatal injuries. ◀

More information on automatic deactivation of the front passenger airbags, refer to page 52.

Installing child-restraint systems

Before installing any child-restraint system or child seat, read the following:

 Observe the child-restraint system manufacturer's instructions for selection, installation and use of the child-restraint system. Otherwise the degree of protection can be reduced.

After an accident, have all parts of the relevant vehicle safety belt system checked by a BMW Sports Activity Vehicle Center and replaced if necessary. ◀

Commercially-available child-restraint systems are designed to be secured with a lap belt or with the lap belt portion of a combination lap/shoulder belt. Improperly or inadequately installed restraint systems can increase the risk

of injury to children. Always read and follow the instructions that come with the system.

Child seat security



All of the rear belt retractors and the front passenger's safety belt can be locked for mounting and securing child-restraint systems.

Information regarding this is located near the buckle latch of each safety belt.

To lock the safety belt

Pull the entire length of the belt from the belt retractor. Allow the reel to retract the belt somewhat and engage the buckle, then tighten the belt against the child-restraint system. The retraction mechanism is now locked.

To unlock the safety belt

Release the buckle, remove the child-restraint system and allow the belt retractor to reel the belt completely in.

Child-restraint system with tether strap

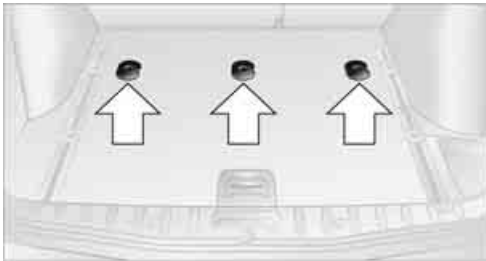

If you use a child-restraint system with a tether strap, three additional tether anchorage points have been provided, refer to the arrows in the illustration. To gain access to this anchor fitting

lift the plastic plug with the help of a screwdriver. Depending on the location selected for seating in the rear passenger area, attach the tether strap to the corresponding anchorage point to secure the child-restraint system, as shown in the illustration below.

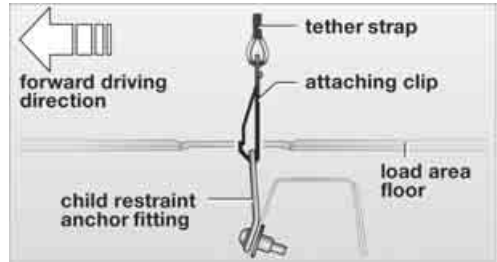

Routing of tether strap

Outer seating positions:

Route the tether strap through the center between the head restraint and the backrest.

Center seating position:

Fold the center armrest forward and pull the tether strap through the opening. Then fold up the center armrest and engage it.



When using the cargo area cover: tether strap must run between the rear backrest and the cargo area cover.



 Adjust the tether strap according to the child-restraint manufacturer's instructions. ◀

LATCH child-restraint fixing system*

LATCH: Lower Anchor and Tethers for Children.

The rear outer seating positions are provided with anchors for a LATCH child-restraint fixing system.

 To fit the LATCH child-restraint fixing system, follow the operating and safety instructions of the system manufacturer. ◀

Access to anchorage points

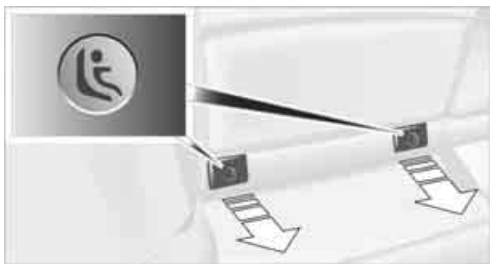

The picture shows the right rear seat as an example. The anchorage points for the LATCH child-restraint fixing system are located behind the cover caps.

Remove the cover caps toward the front.
Press on to remount.

Before attachment of the LATCH child-restraint fixing system, remove the cover caps and pull the belt out of the region of the child-restraint fixing system.

For driving

 With side airbags in the rear, make sure that children do not lean out of the child's seat toward the door panel, as otherwise major injuries can result if the side airbags are triggered. ◀

You can have the rear side airbags permanently deactivated.

Your BMW Sports Activity Vehicle Center will be happy to advise you.

Child-safety lock of rear doors

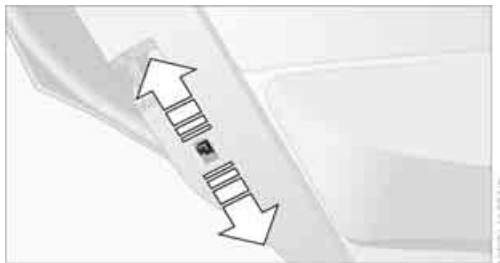

Slide down the safety levers on the rear doors:
The door can now be opened from the outside only.

Safety switch for power windows

Always press the safety switch for the power windows, refer to page 20, when children are in the rear of the vehicle.

Driving

Ignition lock

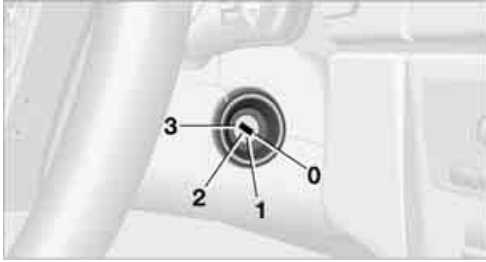

0 Steering locked

The key can be inserted or removed in this position only.

After removing the key, turn the steering wheel slightly to the left or right until you hear the lock engage.

Interlock

Vehicles with automatic transmission:

To turn the key back to position 0 or to remove it, first place the selector lever in position P.

1 Steering unlocked

A slight steering wheel movement often makes it easier to turn the key from 0 to 1.

Some power accessories are ready for operation.

2 Ignition switched on

All vehicle systems are ready for operation.

3 Starting engine

Engine

Do not allow the engine to warm up while idling. Begin driving immediately at moderate engine speed.

The engine idle speed is controlled by the engine computer system. Increased idle speeds at startup are normal and should

decrease as the engine warms up. If engine speed does not decrease, service is required.

To prevent the battery from discharging, always switch off electrical devices which are not in use and the ignition when the vehicle is not being driven.



Do not run the engine in closed rooms, as otherwise inhaling toxic exhaust gases can cause unconsciousness and death. The exhaust gases contain carbon monoxide, an odorless and colorless, but highly toxic gas. Do not leave the vehicle unattended with the engine running, since an unattended vehicle with a running engine represents a safety hazard.

When driving, standing at idle and while parking take care to avoid possible contact between a hot exhaust system and any highly flammable materials such as hay, leaves, grass etc. Such contact could lead to a fire, resulting in serious personal injury and property damage. ◀

Indicator lamps



If the Service Engine Soon indicator lamp comes on either continuously or intermittently, this indicates a malfunction in the emissions-related electronic systems. Although the vehicle remains operational, you should have the systems checked by your BMW Sports Activity Vehicle Center at the earliest possible opportunity.

The illuminated indicator informs you of the need for service, not that you need to stop the vehicle. However, the systems should be checked by your BMW Sports Activity Vehicle Center at the next opportunity.

If the indicator blinks or flashes, this indicates a high level of engine misfire. Reduce speed and contact the nearest BMW Sports Activity Vehicle Center immediately. Severe engine misfiring over even a short period of time can seriously damage emission control system components, especially the catalytic converter.



Display of the previously described malfunction on Canadian models.



The warning lamp lights up. Malfunction in the engine electronics. You can continue to drive with reduced engine output or speed. Have the system checked immediately.

Starting engine

When starting the engine, do not press the accelerator pedal.

Vehicles with manual transmission:

Step on the clutch when starting the vehicle.

A locking mechanism prevents the engine from starting if the clutch is not depressed.

Do not end the starting procedure too early, but do not prolong it for more than 20 seconds. Release the ignition key immediately as soon as the engine starts.

If the engine fails to start on the first attempt, for instance, if it is very hot or cold:

Press the accelerator pedal halfway down while engaging the starter.

During a cold start at very low temperatures, below approx. +5 °F / -15 °C, at high altitudes over 3,300 ft/1,000 m:

- ▷ Engage the starter for approx. 10 seconds the first time.
- ▷ Press the accelerator pedal halfway down while engaging the starter.

 Avoid frequent starting in quick succession or repeated start attempts in which the engine does not start. Otherwise, the fuel is not burned or inadequately burned and there is a danger of overheating and damaging the catalytic converter. ◀

Manual transmission

1. Apply the handbrake.
2. Shift into neutral.
3. Press the clutch pedal.
If the clutch pedal is not pressed, the engine cannot be started.
4. Start the engine.



Before leaving the vehicle with the engine running, place the gearshift lever in neutral position and engage the handbrake. Never leave an unattended vehicle with the engine running, as such a vehicle represents a potential safety hazard. ◀

Automatic transmission

1. Press the brake pedal.
2. Engage selector-lever position P or N.
3. Start the engine.



To prevent the vehicle from rolling, always select position P and engage the handbrake before leaving the vehicle with the engine running. Never leave an unattended vehicle with the engine running, as such a vehicle represents a potential safety hazard. ◀

Switching off engine



Do not remove the ignition key when the vehicle is moving, as otherwise the steering could lock.

When leaving the vehicle, always remove the ignition key and lock the steering.

When parking on downward inclines, engage the handbrake. ◀

Manual transmission

Turn the ignition key to position 1 or 0.

Automatic transmission

Engage selector-lever position P, turn ignition key to position 1 or 0.

Handbrake

The handbrake is primarily intended to prevent the vehicle from rolling while parked; it brakes the rear wheels.

Indicator lamp



The indicator lamp lights up red. An acoustic signal also sounds when you begin to drive. The handbrake is engaged.



Indicator lamp for Canadian models.

Engaging

The lever engages automatically and the indicator lamp in the instrument cluster lights up from ignition key position 1.



Releasing

Pull up slightly on the lever, press the button and lower the lever.

! If exceptional circumstances should make it necessary to engage the handbrake while the vehicle is in motion, do not pull it too strongly. In doing so, continuously press the button of the handbrake lever. Strong application of the handbrake can lead to overbraking of the rear axle and to associated 'fishtailing' of the vehicle rear end.

The brake lamps do not light up when the handbrake is applied. ◀

▷ To prevent corrosion and one-sided braking action, occasionally engage the handbrake lightly when the vehicle is slowly coming to a stop at a traffic light if the traffic conditions are suitable. ◀

Manual transmission

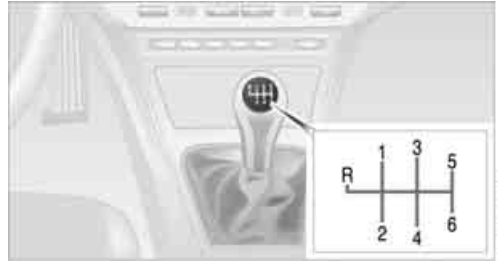

! When shifting into 5th or 6th gear, make sure that you press the gearshift lever to the right to prevent inadvertently shifting into 3rd or 4th.

Do not hold the vehicle in place on slopes by slipping or riding the clutch. Otherwise greater clutch wear will result. ◀

Reverse

Select only when the vehicle is stationary. Press the gearshift lever to the left to overcome the resistance.

As you do this, the backup lamps will turn on automatically when the ignition key is in position 2.

Automatic transmission with Steptronic

In addition to fully automatic operation, you can also manually shift with the Steptronic, refer to page 37.

Selector-lever positions

P R N D M/S + -

Starting engine

The engine can only be started in selector lever positions P: Park or N: Neutral.

Possible displays



P R N D SD M1 M2 M3 M4 M5

The selector lever position is indicated, and in the manual mode the gear currently engaged.

Range selection



An interlock prevents inadvertent gearshifts into selector-lever positions R and P. To cancel the interlock, press the button on the front of the selector-lever knob, refer to arrow.

Shiftlock

With the vehicle stationary, press the brake pedal before shifting out of P or N; the shift command will not be executed unless the brake is applied.

To prevent the vehicle from 'creeping' after you select a gear, maintain pressure on the brake pedal until you are ready to start.

 To prevent the vehicle from rolling, always select position P and engage the handbrake before leaving the vehicle with the engine running. ◀

P Park

Select only when the vehicle is stationary. The transmission locks to prevent the rear wheels from turning.

R Reverse

Select only when the vehicle is stationary.

N Neutral

For example, engage in automatic car washes. The vehicle can roll.

D Drive, automatic shift program

This position is designed for driving under all normal operating conditions. All forward gears are available.

Kick-down

The kick-down mode provides maximum acceleration.

Press the accelerator pedal past the increased resistance point at the full-throttle position.

M/S Manual mode and Sport Program



Move the selector lever from position D to the left into shifting slot M/S:

The sport program is activated and SD appears in the instrument cluster. This position is recommended for a performance-oriented driving style.

When the selector lever is moved briefly towards + or -, manual operation is activated and the Steptronic shifts gears. The instrument cluster shows M1 through M5.

Upshifts and downshifts are executed only when they will result in a plausible combination of engine and vehicle speed; as a result, for example, a downshift that would cause the engine to overrev will not be executed by the system. The gear selected will appear briefly in the instrument cluster followed by the current gear.

To use the automatic function again, move the selector lever to the right into position D.

Malfunction



The warning lamp lights up. A malfunction has occurred in the transmission system. Avoid heavy loads.

While it will still remain possible to move the selector lever to any desired position, the transmission will revert to its default mode with only a limited number of forward gears.

Have the system checked as soon as possible.

Information on towing and jump starting, refer to page 105.

Turn signals/headlamp flasher

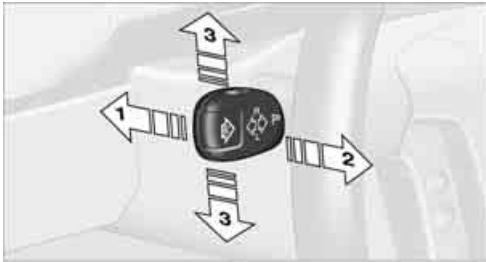

- 1 High beams
- 2 Headlamp flasher
- 3 Turn signals

 Atypically rapid flashing of the indicator lamp indicates that a turn signal bulb has gone out. After the ignition is switched off, make sure that the roadside parking lamps have not been left on. ◀

Signaling briefly

Press lever to resistance point and hold for as long as you wish to signal.

Washer/wiper system/ rain sensor*



- 0 Wipers retracted
- 1 Intermittent or rain sensor operation
- 2 Normal wiper speed
- 3 Fast wipe
- 4 Brief wipe
- 5 Select interval time or set sensitivity of rain sensor

Fold-out position

The right wiper is partially concealed by the hood.

To move the wipers into a vertical position:

1. Switch on wipers in lever position 1.
2. When the wipers are approximately vertical, move the ignition key to position 0.

For changing the wiper blades, refer to page 95.



Fold the wipers back down onto the windshield before you turn the ignition key to position 1 or 2 again. If you do not, they could be damaged. ◀

Intermittent mode

Not on vehicles with rain sensor.

You can set the wipe interval to four stages with the serrated dial 5.

In addition, the wipe interval is varied automatically depending on road speed.

Rain sensor*

The rain sensor automatically controls wiper operation as a function of the rain intensity. It is positioned on the windshield, directly in front of the inside rearview mirror.

 Deactivate the rain sensor when passing through an automatic car wash. Failure to do so could result in damage caused by undesired wiper activation. ◀

Activating

As of ignition key position 1 move the lever to position **1**. The wipers travel once across the windshield, regardless of the weather conditions.

You can leave the lever permanently in position **1** and then only need to activate the rain sensor as of ignition key position 1. To do so:

- ▶ Briefly turn the serrated dial **5** or
- ▶ clean the windshield **1**, refer to next section

Adjusting sensitivity

Turn the serrated dial **5**.

Deactivating

Switch lever to position **0**.

Normal wiper speed

The system switches automatically to intermittent mode when the vehicle is not moving, not on vehicles with rain sensor.

Fast wipe

The wipers operate at normal speed when the vehicle is not moving, not on vehicles with rain sensor.

Cleaning windshield, rear window and headlamps*

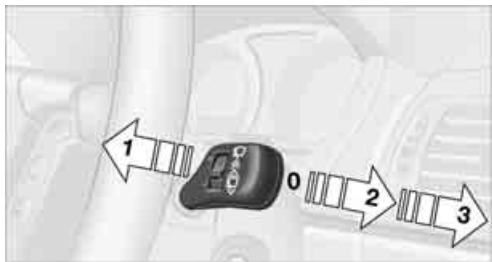

- 0** Wipers retracted
- 1** Cleaning windshield and headlamps
- 2** Rear window wiper intermittent mode
- 3** Cleaning rear window

 Do not use the washers if there is any danger that the fluid will freeze on the windshield. If you do so, your vision could be obscured. To avoid freezing, use a washer fluid antifreeze, refer to page 90. Do not use the washers when the reservoir is empty. This could cause damage to the washer pump. ◀

Cleaning windshield

The system sprays washer fluid against the windshield and activates the wipers for a brief period.

The windshield washer nozzles are automatically heated as of ignition key position 2.

Cleaning headlamps*

When the vehicle lighting system is switched on, the headlamps are cleaned at regular and appropriate intervals.

Rear window wiper

Rear window wiper in intermittent mode. When reverse gear is engaged, the wiper operates continuously.

You can also program the interval:

- 1.** Briefly move the wiper lever from position **0** to position **2**.
- 2.** Wait for desired interval; maximum of 30 seconds.

3. Move the wiper lever from position **0** to position **2** again

To change the wiper blades, refer to page **95**.

Cruise control*

The vehicle maintains and stores the speed that you set as of a speed of approx. 20 mph/ 30 km/h.

You can use cruise control whenever the system is active while the engine is running.

On the sports steering-wheel* the buttons +/- for the cruise control are located on the right-hand side of the steering wheel.

Indicator lamp



The indicator lamp lights up green: System ready for operation using the buttons on the steering wheel.

Activating system

I/O

As of ignition key position 2:

Press button on steering wheel; the indicator lamp in the instrument cluster comes on. You are able to use the cruise control.



Do not use the cruise control under unfavorable conditions that do not permit a constant speed, e.g. when driving on winding roads or in heavy traffic or when negotiating poor road conditions such as snow, rain, ice, or a loose road surface. ◀

Deactivating system

I/O

Press the button repeatedly until the indicator lamp in the instrument cluster goes out.

The cruise control is also deactivated when the ignition key is turned to position 0. The speed stored in the memory is deleted in the process.

Maintaining speed, storing, and accelerating



Briefly press **+** button:

The system maintains and stores the current vehicle speed. Every time you briefly press the button, the vehicle's speed increases by roughly 1 mph/1 km/h.

Press and hold **+** button:

The vehicle accelerates without pressure on the accelerator pedal. When you release the button, the system maintains and stores the current speed.



If, on a downhill gradient, the engine's braking effect is not sufficient, the controlled speed can be exceeded. Speed can drop on uphill grades if the engine output is insufficient. ◀

Decelerating



Briefly press **-** button:

Every time you briefly press the button, the vehicle's speed decreases by roughly 1 mph/ 1 km/h provided that you have already activated the cruise control.

Press and hold **-** button:

With the cruise control active, the system automatically reduces the fuel supply to slow the vehicle. When you release the button, the system maintains and stores the current speed.

Interrupting cruise control



When the system is activated, press button 1. The indicator lamp stays on. You can use the cruise control again whenever required by requesting the speed that was stored last.

In addition, the system is automatically interrupted in response to the following conditions:

- ▷ When you apply pressure to the brake pedal
- ▷ When you apply pressure to the clutch pedal or when you move the automatic transmission selector lever from D to N
- ▷ If you exceed or fall below the controlled speed for an extended period, by pressing the accelerator, for example
- ▷ When DSC is activated

Resuming stored speed



Press button:

The vehicle accelerates to and maintains the last speed stored.

Everything under control

Odometer



- 1 Odometer
- 2 Trip odometer

Odometer

You can activate the displays shown in the illustration in ignition key position 0 or with the ignition key removed by pressing the button in the instrument cluster.

Trip odometer

To reset to zero:

1. Ignition key in position 1.
2. Press and hold the button until the trip odometer is reset to zero.

Tachometer



Engine speeds in the red warning field must absolutely be avoided.

In this range, the fuel supply is interrupted to protect the engine.

Fuel gage

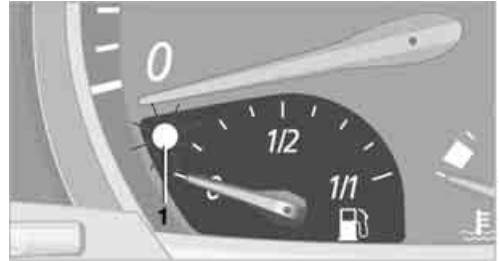

If the indicator lamp **1** starts to light up continuously, there are approx. 2 gallons/8 liters of fuel in the tank.

Fuel tank capacity:

Approx. 17.7 gallons/67 liters.

If the tilt of the vehicle varies, when you are driving in mountainous areas, for example, the indicator may fluctuate slightly.



Refuel well before the tank is empty, as otherwise engine functions will not be ensured and damage can occur if you drive down to the last drop. ◀

When you switch on the ignition, the indicator lamp comes on briefly to confirm that the system is operational.

Coolant temperature gage

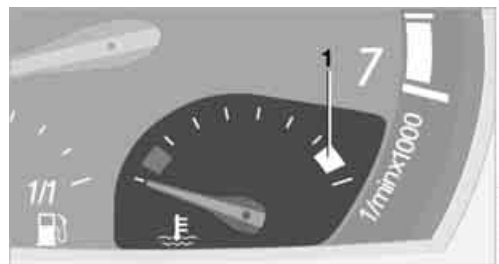

Blue

The engine is still cold. Drive at moderate engine and vehicle speeds.

Between blue and red fields

Normal operating range. It is permissible for the dial to drift up to the red field.

Red

Comes on while driving:

The engine is overheated. Switch off the engine immediately and allow it to cool down.

Checking coolant level, refer to page 91.

When you switch on the ignition, the warning lamp **1** comes on briefly to confirm that the system is operational.

Service Interval Display



Remaining distance until next service due

The displays shown in the illustration appear for a few seconds as of ignition key position 1 or after starting the engine.

Together with the message OIL SERVICE or INSPECTION, the next scheduled service and remaining distance to this service are displayed in miles/kilometers.

The remaining distance is determined on the basis of the past driving style.

A flashing display and a '-' sign before the numerical value mean that the service interval has been passed by the displayed number of miles/kilometers. Please make an appointment with your BMW Sports Activity Vehicle Center.

Clock

If you want to have a continuous clock display, you can also have the time displayed in the display of the car radio, refer to Owner's Manual for Radio.

You can adjust the clock, also for display in the radio, as follows.

Setting time



As of ignition key position 1:

Hours

1. Hold button **2** pressed for a few seconds until the hours are displayed and the colon flashes.
2. Press button **1** repeatedly until the desired hour is set.

Minutes

3. Press button **2** to change to the minutes.
4. Press button **1** repeatedly until the desired minutes are set.
5. Press button **2**.
Time is confirmed.

The set time is transferred to the display of the radio or displayed in the instrument cluster.

Display mode

Ignition key in position 0 or removed:

Press button **1**.

The time and display of the miles/kilometers appear for a few seconds.

Computer*

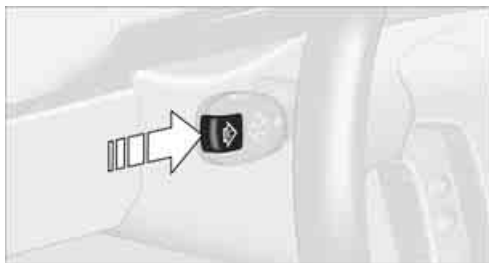

Mode selection

As of ignition key position 1, you can call up information from the computer using the computer button in the turn signal lever.

A new function appears each time you briefly press the computer button.

The displays appear in the following order: Time, outside temperature, average fuel consumption, cruising range, average speed.

As of ignition key position 1, the last active setting is displayed.

 If you desire, you can display the following functions in a different unit of measure. ◀

Outside temperature



Changing unit of measure °F/°C

During the display, hold down the button in the turn signal lever until the display changes.

Ice warning

If the outside temperature falls below approx. +37.5 °F/+3 °C, the computer switches automatically to the outside temperature display. In addition, an acoustic signal sounds and the display flashes for a short time.



After an ice warning has been issued, the display returns to the previous setting. You can have this activated/deactivated. ◀



Please bear in mind that the ice warning does nothing to alter the fact that black ice may be present on roads at temperatures higher than +37.5 °F/+3 °C, for instance, on bridges and shaded roads. ◀

Clock



12 or 24 hour mode

If your vehicle is equipped with a computer, you can have the time displayed in the 12 or 24 hour mode.

During the display, hold down the computer button in the turn signal lever until the display changes.

Average fuel consumption



The average fuel consumption is calculated for the time during which the engine is running.

Reset average consumption: press the computer button in the turn indicator lever for approx. 2 seconds.

Cruising range

Displays the estimated cruising range available with the remaining fuel. The fuel level is measured and the range is calculated taking into account the driving style over the last 20 miles/30 km.



Always refuel as soon as possible once your cruising range falls to below 30 miles/50 kilometers, as otherwise engine functions are not ensured and damage can occur. ◀

Average speed

If you press the computer button for approx. 2 seconds, the currently displayed average value for speed is recalculated from that moment onwards.

Technology for comfort, convenience and safety

PDC Park Distance Control*

The concept

PDC provides extra safety and convenience during parking maneuvers. Signal tones indicate the current distance to an object behind or in front of your vehicle. Four ultrasonic sensors in both the bumpers monitor the distance to the nearest object.

The front and rear sensors on the corners have a range of approx. 2 ft/60 cm. The two rear middle sensors have a range of approx. 5 ft/1.50 m and the two front middle sensors of approx. 2.6 ft/80 cm.

 PDC is a parking aid that can indicate objects when they are approached slowly, as is usually the case when parking. Avoid approaching objects too fast, otherwise the system may give warning of physical obstacles too late. ◀

If you tow a trailer, the rear sensors cannot take any practical measurements. Therefore, they do not switch on.

Automatic mode

In ignition key position 2, the system is automatically activated after approx. one second each time you shift into reverse or move the selector-lever into position R. Wait for this short time span before moving. The system switches off when you shift out of reverse.

 You can have a signal tone programmed into the system to verify that the PDC is active. ◀

Manual mode

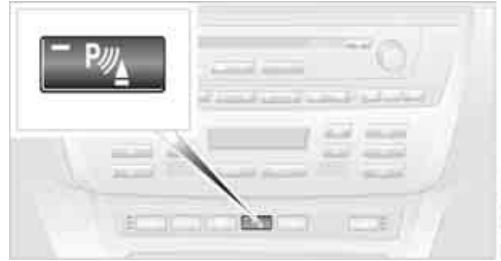

In ignition key position 2, press the button; the indicator lamp lights up.

Deactivating manual mode

Press the button again; the indicator lamp goes out.

After driving a distance of more than approx. 160 ft/50 m or exceeding a speed of approx. 20 mph/30 km/h, the system switches off and the indicator lamp goes out. You can reactivate the system manually as needed.

Signal tones

The distance to an object behind the vehicle is signaled, in accordance with the position, by an intermittent tone from a speaker in the rear.

The distance to an object in front of the vehicle is signaled by an intermittent tone from a loud-speaker beneath the instrument cluster.

As the distance between vehicle and object decreases, the intervals between the tones become shorter. The signal tone becomes continuous once the distance to the nearest object falls to below roughly 1 ft/30 cm.

The signal tone is canceled after approx. 3 seconds when the distance to an object remains constant during this time, if you are moving parallel to a wall, for instance.

Malfunction

The indicator lamp in the button flashes and a short continuous tone sounds. PDC is malfunctioning. Switch off PDC. Have the system checked.

To prevent this problem, keep the sensors clean and free of ice or snow in order to ensure that they will continue to operate effectively.

System limits

 Even with PDC, final responsibility for estimating the distance between the vehicle and any obstructions always remains with the driver. Even when sensors are involved, there is a blind spot in which objects cannot be detected. The system is also subject to the physical limits that apply to all forms of ultrasonic measurement, such as those encountered with tow bars and trailer couplings, or thin and wedge-shaped objects etc. Low objects already displayed, e.g. a curb, can also disappear from the detection area of the sensors again before a continuous tone sounds. Loud sources of sound, inside and outside the vehicle, could drown out the PDC signal tone. ◀

 Keep the sensors clean and free of ice or snow in order to ensure that they will continue to operate effectively. Do not apply high pressure spray to the sensors for a prolonged period of time. Keep the spray at least 4 in/10 cm away from the sensors. ◀

Driving stability control systems

Your BMW is equipped with an extended array of systems designed to enhance and maintain vehicle stability under extreme conditions.

ABS Antilock Brake System

ABS prevents the wheels from locking during braking. Safe steering response is maintained even during full braking. This results in an increase in the active safety.

ABS is operational every time you start the engine. Safe braking, refer to page 73.

EBV Electronic brake-force distribution

EBV controls the brake system's application pressure in the rear wheels to ensure stable deceleration.

DBC Dynamic Brake Control

When the brake pedal is depressed quickly, this system automatically generates a maximal braking force distribution and thus helps keep the braking distance to a minimum during full braking. This system exploits all of the benefits provided by ABS.

Do not reduce the pressure on the brake pedal for the duration of the brake application. DBC is deactivated when you release the brake pedal.

DSC Dynamic Stability Control

DSC prevents slip at the drive wheels when starting off and accelerating. DSC also detects unstable driving conditions, such as a fishtailing of the vehicle's rear end or the sliding of the vehicle on its front wheels. In these circumstances, DSC helps keep the vehicle on a safe path, within physical limits, by reducing engine output and by applying the brakes in individual wheels.

The DSC is operational every time you start the engine.

 The laws of physics cannot be repealed, even with DSC. An appropriate driving style always remains the responsibility of the driver. Therefore, do not reduce the additional safety margin again by taking risks. ◀

Indicator lamp

 The indicator lamp goes out shortly after the engine starts.

When the indicator lamp flashes: DSC is controlling the drive and braking forces.

When the indicator lamp stays lit: DSC has been switched off with the button.

Switching off DSC



Press the button; the indicator lamp in the instrument cluster lights up continuously. DSC is now deactivated.

Stabilizing interventions of the chassis control system DSC are no longer available. However, the braking interventions that simulate the function of the differential lock continue to be active.

In the following exceptional circumstances, it may be useful to switch off DSC for a short period:

- ▷ When rocking the vehicle and starting off in deep snow or on loose road surfaces
- ▷ On sandy road surfaces
- ▷ On poor surfaces with deep ruts
- ▷ If the wheels spin on muddy surfaces
- ▷ When driving with snow chains

 As a result of the braking interventions, the brakes may be subjected to additional loads when the system is switched off. In order to limit the brake temperature, brief automatic suppression of the brake activation is possible. To maintain vehicle stability, always drive with the system switched on when possible. ◀

Reactivating DSC



Press the button again; the indicator lamp in the instrument cluster goes out. DSC is now activated.

xDrive

xDrive is the all-wheel drive system of your X3. The combined effects of xDrive and DSC further optimize the traction and dynamic driving characteristics. The all-wheel drive system xDrive variably distributes the drive torque to the front and rear axle depending on the driving situation and prevailing road conditions.

HDC Hill Descent Control

The concept

HDC is a system for hill descent assistance that reduces the speed on steep downward inclines and makes it even easier to control the driving characteristics of your BMW under these conditions. The vehicle moves at slightly more than walking speed without active intervention from the driver.

HDC is available for activation at vehicle speeds below approx. 20 mph/35 km/h. When driving down steep hills with a speed below approx. 20 mph/35 km/h, the vehicle reduces speed automatically down to slightly more than walking speed, approx. 5 mph/8 km/h, and then maintains this speed at a constant.

You can use the accelerator or brakes to vary this automatically controlled speed within a range extending from approx. 3 mph/5 km/h to 15 mph/25 km/h.

You can specify a target speed within the same range by using the +/- buttons of the cruise control on the steering wheel.

Activating system



Press the button; the indicator lamp comes on. The indicator lamp flashes when the brakes are applied automatically.

Deactivating system

Press the button again; the indicator lamp goes out.

HDC is deactivated immediately above approx. 35 mph/60 km/h and after approx. 10 seconds when the ignition is switched off.

Using HDC

In vehicles with manual transmission:
Use HDC in first gear and in reverse gear, as in the higher gears the engine's braking action diminishes.

On vehicles with automatic transmission:
You can use HDC in every drive position.

Malfunction

If the indicator lamp in the button goes out in the HDC mode or fails to light up when the button is pressed:

HDC is temporarily not available, as the brake temperature is too high.

Malfunction in vehicle stability control systems

 The warning lamp lights up yellow. DBC Dynamic Brake Control is defective. Have the system checked as soon as possible.

 Display of the previously described malfunction on Canadian models.

 If one of the malfunctions described below occurs, proceed cautiously and defensively. When driving on poor roads, avoid using the full throttle or kick-down positions of the accelerator as well as heavy and panic braking. Otherwise the drive train may be damaged or accidents can occur. ◀

 The red brake warning lamp lights up together with the warning lamps for ABS and DSC/xDrive. In addition, a warning signal sounds. ABS, DSC, HDC and xDrive have failed. Drive may then only be carried out via the rear axle. If the brake warning lamp lights up yellow in the described combination, the EBV Electronic brake-force distribution is still available. Have the system checked as soon as possible.

 Display of the previously described malfunction on Canadian models.

 ABS

 4x4

 The warning lamp lights up continuously and a warning signal sounds: DSC or the xDrive all-wheel system has failed.

The stabilizing interventions of DSC or the all-wheel drive system xDrive are no longer available. It is then possible to exert driving force only via the rear axle. Have the system checked as soon as possible.

Flat Tire Monitor

The concept

The Flat Tire Monitor keeps track of the inflation pressures in the four mounted tires as you drive. The system provides an alert whenever the inflation pressure drops significantly in relation to the pressure in another tire.

The check of the tire inflation pressure is based on monitoring the relative speeds of the wheels. A flat tire is detected and reported on the basis of a deviation in certain speed ratios.

Functional requirement

So that the Flat Tire Monitor can learn the correct inflation pressure, please perform the following steps:

1. Check the inflation pressures in all tires
2. Compare with the inflation pressure table on page 83 and correct if necessary
3. Initialize the system.

System limits

 The Flat Tire Monitor cannot indicate sudden severe tire damage caused by outside factors and does not detect a natural, even pressure drop in all four tires. ◀

In the following situations, on the other hand, there can be delays in detecting tire pressure losses, and even system failure:

- ▷ When driving on snow-covered or slippery road surfaces.
- ▷ In the case of performance-oriented driving: slip in the drive wheels, high lateral acceleration.
- ▷ False alarms and undetected loss of pressure may occur when you are driving with snow chains fitted.
- ▷ When driving with a compact wheel, the Flat Tire Monitor cannot operate.

Initializing system

 Perform the initialization immediately every time you correct the inflation pressure, change a tire or change a wheel or all wheels. This requires a trip. ◀

1. Start the engine, but do not begin to drive.



2. Press the button until the yellow indicator lamp in the instrument cluster lights up for a few seconds.
3. Begin driving.

It takes a few minutes until the Flat Tire Monitor can detect and indicate a flat tire.

 Do not initialize the system when driving with snow chains or with a compact wheel. ◀

Indication of a flat tire

 The warning lamp lights up yellow. There is a flat tire or extensive inflation pressure loss.

1. Reduce speed and stop the vehicle carefully. Avoid sudden braking and steering maneuvers.

2. Identify damaged tire.

 If identification is not possible, contact your BMW Sports Activity Vehicle Center. ◀

3. Replace the damaged wheel, refer to Changing a wheel on page 99.

Brake Force Display

The Brake Force Display lights up in two stages, depending on how heavily you brake.

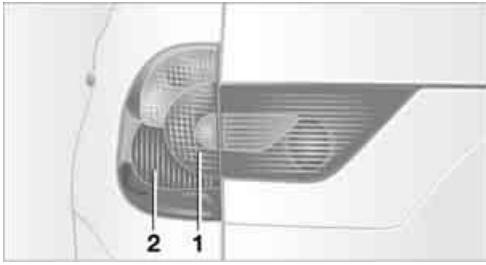

The display consists of two stages:

- ▷ Normal braking:
The brake lamps **1** and the center brake lamp light up.
- ▷ Heavy braking and braking with ABS:
The brake lamps **1** and **2** light up together with the center brake lamp.

Airbags

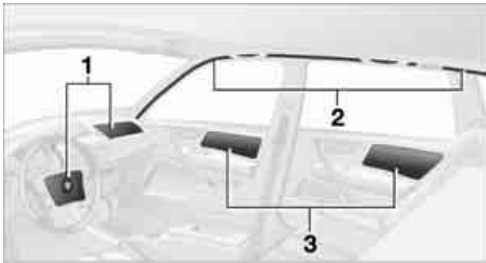

The following airbags are located beneath the marked covers:

- 1** Front airbags for driver and front passenger
- 2** Head airbags in front and rear
- 3** Side airbags in front and rear*

Protective action

 To ensure that the safety systems continue to provide optimal protection, please follow the instructions on page 24. ◀

The front airbags help protect the driver and front passenger by responding to frontal impacts in which safety belts alone cannot provide adequate restraint. When needed, the head and side airbags help provide protection in the event of side impact. The relevant side air-

bag supports the side upper body area. The respective head air bag supports the head.

The airbags are deliberately not triggered in every impact situation, e.g. less severe accidents, certain roll-over situations or rear-end collisions.

 Labels in the rear door opening should indicate the status of your rear seat side airbags. If you are uncertain of their status, or wish to have the airbags activated or deactivated, please contact your BMW Sports Activity Vehicle Center. ◀

For information on the correct sitting position, refer to page 24.

 Do not apply adhesive materials to the cover panels of the airbags, cover them or modify them in any other way.

Do not attempt to remove the airbag retention system from the vehicle. Never modify or tamper with either the wiring or the individual components in the airbag system. This category includes the upholstery in the center of the steering wheel, on the instrument cluster, the side trim panels on the doors, and the roof pillars along with the sides of the headliner. Do not attempt to remove or dismantle the steering wheel.

Do not touch the individual components directly after the system has been triggered, because there is a danger of burns. When there are malfunctions, when deactivating, or after the triggering of the airbag restraint system, have the testing, repair, removal, and disposal of the airbag generators executed only by your BMW Sports Activity Vehicle Center or at a workshop that works according to BMW repair procedures with correspondingly trained personnel and has the required explosives licenses. Unprofessional attempts to service the system could lead to failure in an emergency or undesired airbag activation, either of which could result in personal injury. ◀

Airbag warning information is also provided on the sun visors.

Automatic deactivation of front passenger airbags

Your BMW has a seat occupation detection system. By evaluating the weight on the front passenger's seat, the system detects whether or not the seat is occupied by a child in the child-restraint system or an adult.

- ▷ When a child is seated in the child-restraint system or with an empty seat, the front and side airbags are deactivated on the passenger side.
- ▷ When an adult is traveling in the front seat, the front and side airbags remain active on the passenger side.

 Although not desired, it can occur in the case of heavier children that the front passenger airbags remain active or in the case of very light adults or young persons that the front passenger airbags are deactivated. In these cases, have the person ride in the rear seat, refer to Passenger airbag status lamp below. Do not load the passenger seat with any items in addition to the person to be transported. Do not fit seat covers, seat cushion padding, ball mats or other items onto the front passenger seat unless they are specifically recommended by BMW. Do not place any items under the seat. Otherwise, the function of the seat occupation detection could be impaired. ◀

Operational readiness of airbag system



As of ignition key position 1, the warning lamp lights up briefly, thus indicating the operational readiness of the entire airbag system and the safety belt tensioners.

Airbag system malfunction

- ▷ The warning lamp does not light up as of ignition key position 1.
 - ▷ The warning lamp lights up continuously.
-  Have the airbag system checked immediately if a malfunction occurs, as otherwise there is a danger of the system failing to respond in the expected manner to an impact occurring within its normal response range. ◀

Passenger airbag status lamp



One of the illustrated indicator lamps is located above the interior rearview mirror.

The indicator lamp indicates whether the front passenger airbag system is active or not active/OFF.

 The indicator lamp is used only for the front passenger airbag system. The indicator lamp illuminates to show that the front passenger airbag system is OFF/not active. ◀

- ▷ The indicator lamp goes out after a few seconds. The front passenger airbags are active, e.g. when transporting an adult.
- ▷ The indicator lamp lights up continuously. The front passenger airbags are deactivated, e.g. when a child is traveling in the vehicle in the child-restraint system or when the seat is empty.

Find more information about passenger airbag system and seat occupancy detection in section Automatic deactivation of front passenger airbags above.

Lamps

Parking lamps/low beams



Parking lamps

 The front, rear and side vehicle lighting is switched on. You can use the parking lamps for parking. For lighting on one side for parking as an additional feature, refer to page 54.

Low beams

 When you switch off the ignition with the headlamps on, the headlamps go out and only the parking lamps remain on.

Lamp defective

 The indicator lamp lights up. At least one bulb of the exterior lighting on the vehicle is defective.

Replacing bulbs, refer to page 95.

Pathway lighting

When you activate the headlamp flasher after parking the vehicle and switching off the lamps, the low beams will come on for a brief period.

 You may also have this function deactivated if you wish. ◀

Lights on warning

If you turn the ignition key to position 0, an acoustic signal sounds when you open the driver's door for a few seconds to remind you that the lights have not yet been switched off.

Daytime driving lamps*

You can leave the light switch in the second position: all external lamps go out when you switch off the ignition.

Always observe all applicable laws governing the use of daytime driving lamps.

You can switch on the parking lamps when needed using the standard procedure described under Parking lamps.

 You can have the daytime driving lamps activated on your vehicle. ◀

Automatic headlamp control*

 When you set the switch to this position, the system activates and switches on and off the low beams in response to changes in ambient light conditions, for instance, in tunnels, at dawn and dusk, and in rain and snow.

 The low beams remain switched on regardless of the ambient light when you switch on the front fog lamps. ◀

 Automatic headlamp control cannot serve as a substitute for the driver's judgment in determining when the vehicle lamps should be switched on. For example, the system cannot detect fog. To avoid safety risks, you should always switch on the lamps manually under these conditions. ◀

 You can have the sensitivity of the headlamp control adjusted. ◀

Adaptive Head Light*

The concept

Adaptive Head Light is a variable headlamp control system that enables better illumination of the road surface. Depending on the steering angle and other assumptions, the light from the headlamp follows the course of the road.

Activating Adaptive Head Light



In ignition key position 2, turn the light switch to the position Automatic headlamp control, refer to page 53.

To avoid blinding oncoming traffic, the Adaptive Head Light

- ▷ is not active when driving in reverse
- ▷ is only active toward passenger's side when stationary

Malfunction

The LED next to the symbol for automatic headlamp control flashes. Adaptive Head Light is faulty or has failed. Have the system checked as soon as possible.

High beams/roadside parking lamps

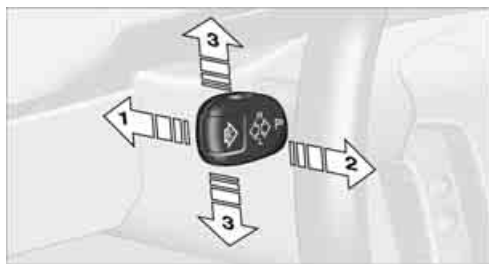

- 1 High beams
- 2 Headlamp flasher
- 3 Roadside parking lamps

Roadside parking lamps, left or right*

You also enjoy the option of lighting up just one side of your vehicle when parking. When using this function, comply with national regulations:

In ignition key position 0 or with ignition key removed:

Move the lever into the corresponding turn signal position.

- ▷ The roadside parking lamps drain the battery. Avoid using for longer periods, as otherwise it may not be possible to start the engine. ◀

Fog lamps*



Briefly press the button once again to switch on/off.



The parking lamps or low beams must be switched on for the fog lamps to operate. The green indicator lamp lights up when the fog lamps are.



If the automatic headlamp control is activated, the low beams will come on automatically when you switch on the fog lamps. ◀

Instrument lighting

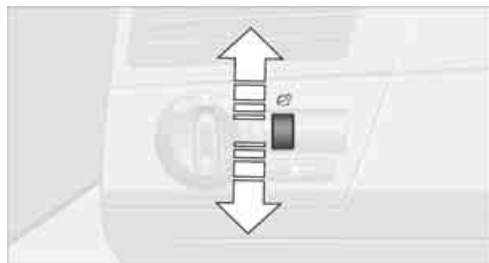

Turn the serrated dial to adjust the illumination intensity.

Interior lamps



 To avoid discharging the battery, all of the vehicle's interior lamps are automatically extinguished approx. 15 minutes after the ignition is switched off. ◀

The interior lamps operate automatically.



If you desire, the interior lamps are switched on after mechanical unlocking of the vehicle. You may have this function activated/deactivated if you wish. ◀



If the interior lamps remain switched on after locking the vehicle, one of the doors or the tailgate may not be completely closed. ◀

Switching interior lamps on and off

Briefly press button 1.

If you want the interior lamps to remain off all the time, press and hold the button for approx. 3 seconds.

Press the button briefly to revert to normal operation.



You can have soft dimming of the interior lamps set. ◀

Front reading lamps*

Switch on and off with buttons 2.

Rear reading lamps*

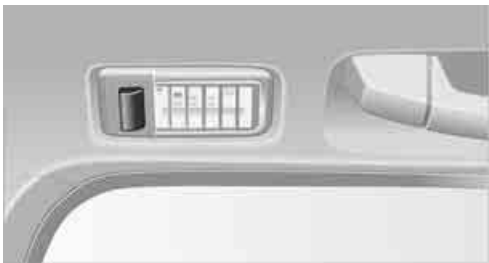

Switch on and off with the button.

A congenial climate

Air conditioner

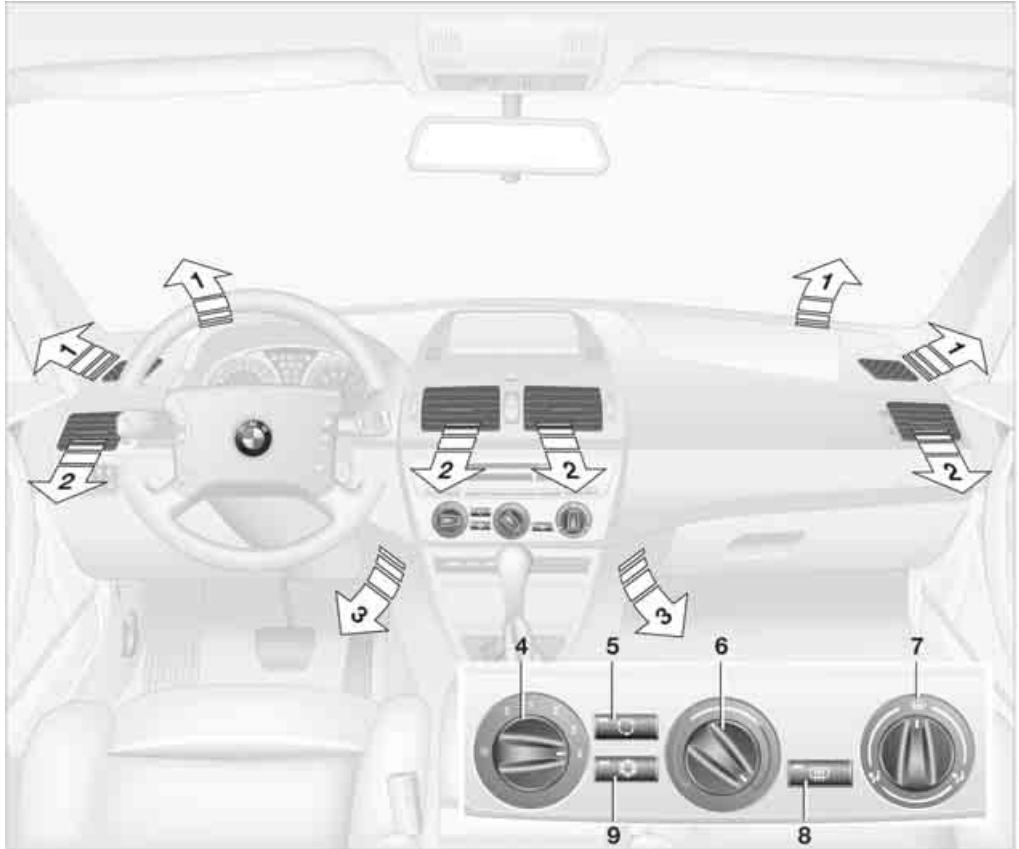

- 1 Airflow directed toward the windshield and side windows
- 2 Airflow for the upper body [57](#)
- 3 Front footwell ventilation [57](#)
- 4 Air supply/blower [57](#)
- 5 Outside air/recirculated-air mode [57](#)
- 6 Temperature [57](#)
- 7 Air distribution [57](#)
- 8 Rear window defroster [57](#)
- 9 Air conditioner [57](#)

Air supply/blower



You can select blower speeds 1 to 4. The heating and ventilation become more and more effective as the air supply settings are increased. In position 0, the blower and heater are switched off. The air supply is blocked in position 0.





Temperature



To increase the temperature of the interior, turn to the right.

Air distribution



You can direct air to flow onto the windows , toward the upper body  and into the footwell . All intermediate settings are possible. In the  setting, there is a slight flow of air onto the windows to keep them free of condensation.

Rear window defroster



When the rear window defroster is activated, the indicator lamp comes on. The rear window defroster switches off automatically.



You can have your vehicle programmed in such a way that the rear window defroster switches on automatically. It is then switched on at outside temperatures of less than approx. +39 °F/+4 °C within 5 minutes of the engine start. ◀

Air conditioner



The air is cooled and dehumidified and warmed again as needed, depending on the temperature setting. Depending on the weather, the windshield may fog over briefly when the engine is started. You can reduce condensation forming on the windows by switching on the air conditioner.



Condensation forms in the air conditioner system during operation, and then exits under the vehicle. Traces of condensed water under the vehicle are therefore normal. ◀

Outside air/recirculated-air mode



You can respond to unpleasant odors outside the vehicle by temporarily switching off the outside air supply. The system then recirculates the air currently within the vehicle.



If condensation starts to form on the inside window surfaces during operation in the recirculated-air mode, you should switch it off while also increasing air supply as required. The recirculated-air mode should not be used over a sustained period of time, otherwise the air quality inside the vehicle will deteriorate. ◀

Ventilation

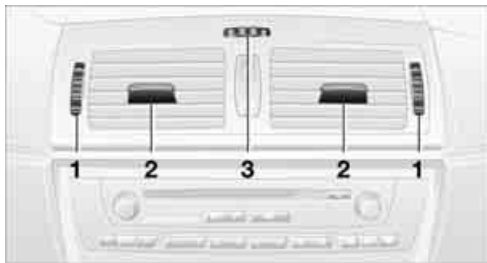

The air vents for the upper body area can be adjusted:

- 1 Serrated dials**
Serrated dials for opening and closing the vent outlets through an infinitely-variable range.
- 2 Levers**
Selector levers for airflow direction.
- 3 Serrated dial**
Use this serrated dial to adjust the amount of cool air that is added to the airflow emerging from the vent outlets for the upper body.

Ventilation for cooling

Adjust the vents to direct the flow of cool air in your direction, for instance, if the interior has become too warm.

Draft-free ventilation

Set the vent outlets so that the air flows past you and is not directed straight at you.

Microfilter

The built-in microfilter removes dust and pollen from the incoming outside air. It is replaced when maintenance is performed by your BMW Sports Activity Vehicle Center. A substantial reduction in air supply indicates that the filter should be replaced before normal maintenance.

Defrosting windows and removing condensation

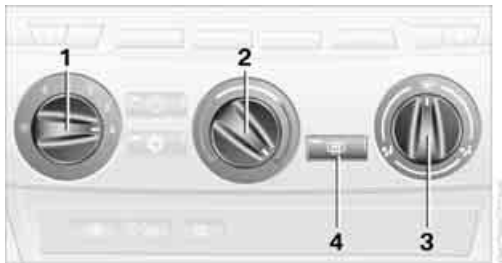

- 1 Rotary blower switch**
Set the rotary switch for air supply at level 4.
- 2 Rotary temperature switch**
Turn completely to the right.
- 3 Rotary switch for air distribution**
Turn to position .
- 4 Rear window defroster**
Switch on to defrost the rear window.

Automatic climate control*

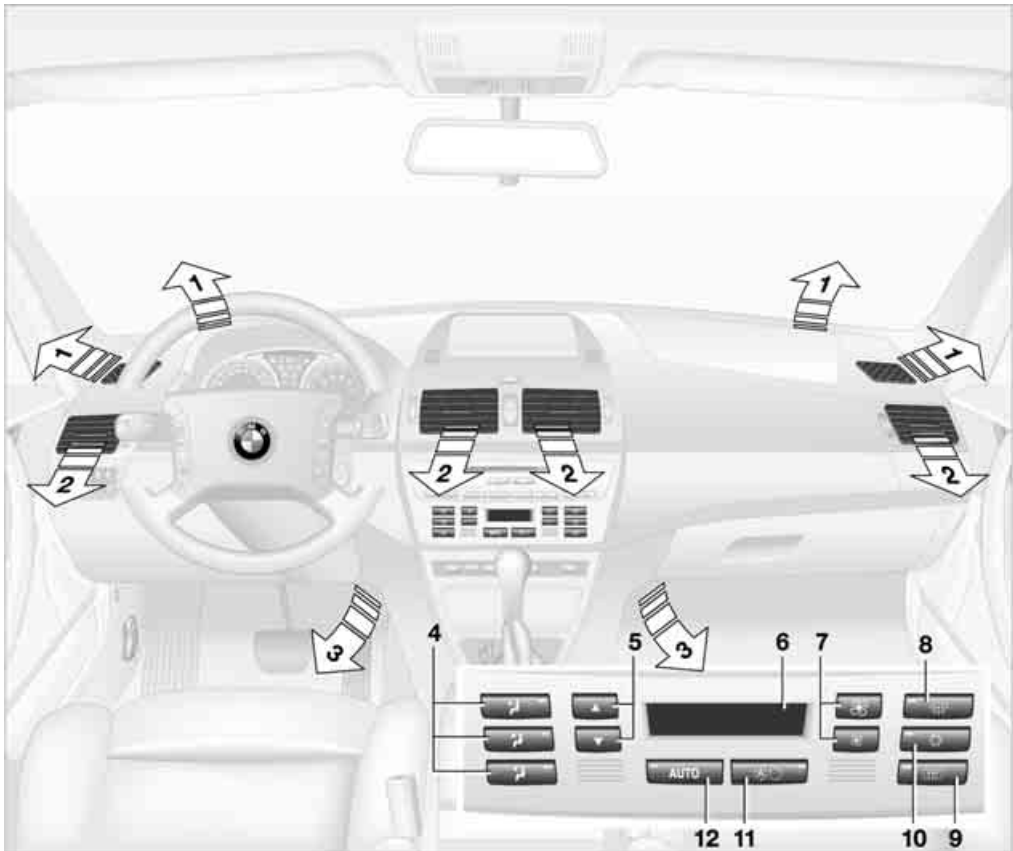

- 1 Airflow directed toward the windshield and side windows
- 2 Airflow for the upper body [61](#)
- 3 Air to footwell [61](#)
- 4 Individual air distribution [60](#)
- 5 Temperature [60](#)
- 6 Temperature display [60](#)
Air supply [60](#)
- 7 Air supply/blower [60](#)
- 8 Defrosting windows and removing condensation [60](#)
- 9 Rear window defroster [61](#)
- 10 Air conditioner [60](#)
- 11 Outside air/AUC Automatic recirculated-air control/recirculated-air mode [60](#)
- 12 Automatic air distribution and supply [60](#)

A congenial climate

For almost all conditions, the AUTO program **12** offers the optimal air distribution and air volume. Select an interior temperature you find pleasant.

The following section contains more detailed information on the available setting options.





 Your vehicle has been designed to automatically select your personal climate-control settings whenever you unlock the doors using your individually programmed remote control. ◀

Automatic air distribution and supply



 The AUTO program adjusts the airflow and distribution patterns for you while also using your pre-selected temperature setting as the basis for adjusting the interior climate to adapt to external influences: summer, winter.

The cooling is switched on automatically with the AUTO program.



Individual air distribution

 You can cancel the AUTO program by selecting specific air distribution patterns for your personal comfort, the automatic air supply remains in operation. You can direct air to flow onto the windows , toward the upper body , and into the footwell . You can reactivate the automatic air distribution mode by selecting the AUTO button.

Adjusting temperature



 The figures in the display provide a general indication of interior temperature. When you start the vehicle, the AUTO program ensures that the selected temperature is achieved as quickly as possible. It then maintains this temperature, regardless of the season.

Air supply/blower



 You can vary the air supply by pressing the upper or lower button. This switches off the automatic program for the air supply, and the word AUTO goes out in the display. The automatic mode for air distribution remains in operation as before. You can reactivate the automatic air supply mode by selecting the AUTO button.

If you press the lower button when at the lowest blower speed, all displays go out: the blower, heating and air conditioner are switched off. The outside air supply is shut off. You can restart the automatic climate control by pressing any of its buttons.

Defrosting windows and removing condensation

 This program quickly removes ice and condensation from the windshield and door windows.

Air conditioner

 When the air conditioning is on, the air is cooled, dehumidified, and then reheated depending on the temperature setting. Depending on the weather, the windshield may fog over briefly when the engine is started. The air conditioner reduces the formation of condensation on the windows.

The air conditioner can only operate when the engine is running and is automatically switched on with the AUTO program.

 Condensation forms in the air conditioner system during operation, and then exits under the vehicle. Traces of condensed water under the vehicle are therefore normal. ◀

Outside air/AUC Automatic recirculated-air control/recirculated-air mode

 You can respond to unpleasant odors or pollutants in the immediate environment by suspending the supply of outside air. The system then recir-

culates the air currently within the vehicle. During AUC operation, a sensor detects pollutants in the outside air and controls the shut-off automatically.

Press the button repeatedly to run through the following control sequence:

- ▷ Indicator lamps off: outside air flows into the vehicle.
- ▷ Left indicator lamp on, AUC mode: the system recognizes pollutants in the outside air and blocks the flow of air when necessary. The system then recirculates the air currently within the vehicle. Depending on the air quality, the automatic system then switches back and forth between outside air supply and recirculation of the air within the vehicle.
- ▷ Right-hand indicator lamp on: the outside air supply into the vehicle is shut off continuously. The system then recirculates the air currently within the vehicle.

 If condensation starts to form on the inside window surfaces during operation in the recirculated-air mode, you should switch it off while also increasing air supply as required. The recirculated-air mode should not be used over a sustained period of time, otherwise the air quality inside the vehicle will deteriorate. ◀

Rear window defroster



When the rear window defroster is activated, the indicator lamp comes on. The rear window defroster switches off automatically.



You can have your vehicle set so that the rear window defroster switches on automatically. It is then switched on at outside temperatures of less than approx. +39 °F/+4 °C within 5 minutes of the engine start. ◀

Ventilation

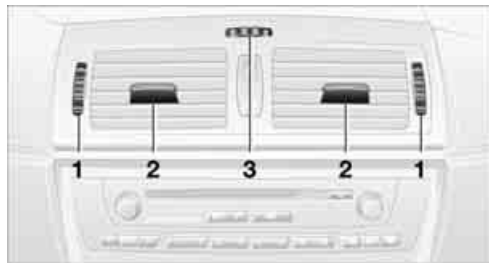

The air vents for the upper body area can be adjusted:

- 1 Serrated dials**
Serrated dials for opening and closing the vent outlets through an infinitely-variable range.
- 2 Levers**
Selector levers for airflow direction.
- 3 Serrated dial**
Use this serrated dial to adjust the amount of cool air that is added to the airflow emerging from the vent outlets for the upper body.

Ventilation for cooling

Adjust the vents to direct the flow of cool air in your direction, for instance, if the interior has become too warm.

Draft-free ventilation

Set the vent outlets so that the air flows past you and is not directed straight at you.

Microfilter/activated-charcoal filter*

The built-in microfilter removes dust and pollen from the incoming air. The activated-charcoal filter provides additional protection by filtering gaseous pollutants from the outside air. This combined filter is replaced when maintenance is performed by your BMW Sports Activity Vehicle Center. A substantial reduction in air supply indicates that the filter should be replaced before normal maintenance.

Practical interior accessories

Integrated universal remote control*

The concept

The integrated universal remote control replaces up to three different hand-held transmitters for various items of radio-controlled equipment such as door openers and house alarm systems. The integrated universal remote control recognizes and learns the transmitted signal of each of the original hand-held transmitters.

The signal of an original hand-held transmitter can be programmed on one of the three memory buttons **1**. Once this is done, each of the devices can be actuated with the appropriately programmed memory button **1**. The indicator lamp **2** confirms transmission of the signal.

Should you sell your vehicle one day, be sure to delete the stored programs beforehand for your safety, refer to page 63.

 To prevent possible damage or injury, before programming or using the integrated universal remote control, always inspect the immediate area to make certain that no people, animals or objects are within the travel range of the device. Also, comply with the safety precautions of the original hand-held transmitter. ◀

Checking compatibility

 If you see this symbol on the packaging or in the manual supplied with the original hand-held transmitter, it is safe to assume that it is compatible with the integrated universal remote control.

 If you have additional questions, please consult your BMW Sports Activity Vehicle Center or call 1-800-355-3515. You can also visit these websites:
www.bmwusa.com or
www.homelink.com.

HomeLink is a registered trademark owned by Johnson Controls, Inc. ◀

Programming

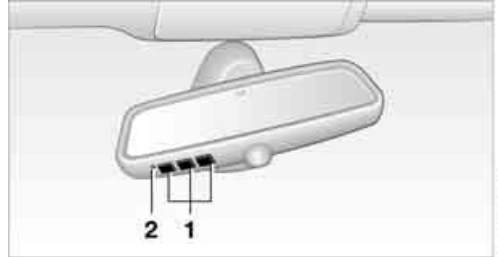

- 1** Memory buttons
- 2** Indicator lamp

Fixed-code hand-held transmitters

1. Turn the ignition key to position 2.
2. For initial use:
Press both outer buttons **1** for approx. 20 seconds, maintaining pressure until the indicator lamp **2** starts to flash. The three memory buttons **1** are cleared.
3. Hold the original hand-held transmitter at a distance of approx. 2 in/5 cm to 8 in/20 cm from the memory buttons **1**.
 The required distance between the hand-held transmitter and memory buttons **1** depends on the relevant system of the original hand-held transmitter used. ◀
4. Simultaneously press the transmit button on the original hand-held transmitter and the desired memory button **1** of the integrated universal remote control. Initially, the indicator lamp **2** flashes slowly. Release both buttons as soon as the indicator lamp **2** flashes rapidly. If the indicator lamp **2** does not flash rapidly after approx. 15 seconds, change the distance.
5. To program other original hand-held transmitters, repeat steps 3 and 4.

The corresponding memory button **1** is now programmed with the signal of the original hand-held transmitter.

You can use the system when the engine is running or when the ignition is switched on.

 If the system cannot be operated after repeated programming, check whether the original hand-held transmitter uses an alternating-code system. To do so, either read the instructions of the original hand-held transmitter or press and hold down the programmed memory button **1** of the integrated universal remote control. If the indicator lamp **2** on the integrated universal remote control flashes rapidly for a short time then lights up for approx. 2 seconds, this indicates that the original hand-held transmitter uses an alternating-code system. In the case of an alternating-code system, program the memory buttons **1** as described at the section on alternating-code transmitters. ◀

Alternating-code transmitters

Consult the operating instructions of the unit you wish to set when programming the universal remote control. You will find information there on the possibilities for synchronization. When programming hand-held transmitters that employ an alternating code, please follow these additional instructions:

 Programming will be easier with the aid of a second person. ◀

1. Park your vehicle within the range of the remote-controlled equipment.
2. Program the integrated universal remote control as described above at Fixed-code hand-held transmitters.
3. Locate the button at the receiver of the equipment to be set, e.g. on the drive.
4. Press the button on the receiver of the device you want to set up. After step 4, you have approx. 30 seconds for step 5.
5. Press the programmed memory button **1** of the integrated universal remote control three times.

The corresponding memory button **1** is now programmed with the signal of the original hand-held transmitter.

 If you have questions, please contact your BMW Sports Activity Vehicle Center. ◀

Clearing memory buttons

Press both outer buttons **1** for approx. 20 seconds until the indicator lamp **2** starts to flash: all of the memory buttons are cleared.

The memory of individual memory buttons **1** cannot be cleared.

Cup holders

Front



Depending on your optional equipment, the center console contains either one or two cup holders.

Passenger side*



The cup holder for the front passenger is located beneath the air/heating vent.

1. Press the trim piece below the air/heating vent, arrow.
2. Insert cup.

Rear

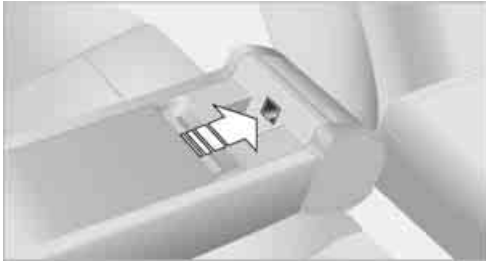

A cup holder is located in the center armrest at the rear:

Press the button to open.

! Do not place glass containers in the cup holders, as otherwise there is a danger of injury in an accident. ◀

Glove compartment

Opening



Pull the handle. The lamp inside the glove compartment comes on.

Closing

Fold the cover up.

! To prevent injury in the event of an accident, close the glove compartment immediately after use. ◀

Locking

Use one of the master keys. A master key is also required for unlocking.

▷ If you only hand over the spare key, e.g. in a hotel for valet parking, refer to page 16, the glove compartment cannot be accessed. ◀

Rechargeable flashlight

The flashlight is located on the left side of the glove compartment. Because it is protected against overcharging, the flashlight can remain continually inserted in its holder.

! Be sure that the flashlight is switched off when it is inserted into its holder. Failure to comply with this precaution could lead to extreme discharging and damage. ◀

Storage compartments

Armrest, front*

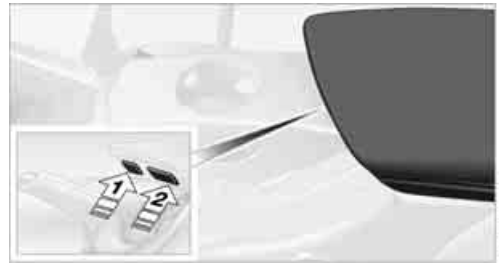

The armrest contains two storage compartments.

- ▷ Compartment for CDs:
Press button 1.
- ▷ Compartment for coins and miscellaneous items:
Press button 2.

Armrest, rear



The rear armrest contains a storage compartment:

To open, pull the cover upward.

Storage compartment in the instrument panel*



Opening

Press the button in the direction of the arrow.

Closing

Fold the cover down.

Storage package*

Your convenience is enhanced by:

- ▷ Armrest, front
- ▷ Sliding lashing eyes in cargo area, refer to page 69
- ▷ Floor cover in cargo area that can be used in two positions, refer to page 69
- ▷ Nets in cargo area, on rear side of front seat, and in passenger footwell

Clothes hooks

 When suspending clothing from the hooks ensure that it will not obstruct the driver's vision. Do not hang heavy objects on the hooks. If you do so, they could cause endanger passengers during braking or evasive maneuvers. ◀

Ashtray*



Press the edge of the opened cover: the ashtray moves up and can be removed.

On vehicles with the non-smoking package, the insert is removed in the same way.

Lighter*

Press in the cigarette lighter 1.

The lighter can be removed as soon as it pops out.

 Hold or touch the hot cigarette lighter by the knob only. Holding or touching it in other areas could result in burns. The cigarette lighter remains operational when the ignition key has been removed. For this reason, do not leave unsupervised children in the vehicle. ◀

Power socket

The cigarette lighter socket can be used as a power socket to plug in hand flashlights, car vacuum cleaners, etc., with power ratings of up to approx. 200 W at 12 V. Avoid damage to the socket caused by inserting plugs of a different shape or size. With the non-smoker's equipment package the socket is covered with a removable cap.

Car phone preparation*

Hands-free system



In vehicles with car phone preparation*, the hands-free microphone is located on the headliner near the interior lamp.

For more information on the car phone, refer to the Owner's Manual for Telephone.

Ski bag*

The ski bag allows the safe and clean transport of up to 4 pairs of standard skis or up to two snowboards.

The ski bag itself plus the additional capacity provided by the cargo area make it possible to transport skis with a length of up to 6.9 ft/ 2.10 m. When skis of 6.9 ft/2.10 m in length are loaded the ski bag will tend to narrow, reducing its overall capacity.

Loading

1. Fold down the center armrest, pull off the cover, press the button and remove the cover.



2. Press the button again; the cover in the cargo area opens. If you press the button

firmly the first time, this also opens the cover in the cargo area.

3. Place the ski bag between the front seats and load.
The zipper facilitates access to the stowed items.
4. Insert the belt tongue of the ski bag retaining belt into the center safety belt buckle.



Make sure to load only clean skis into the ski bag. Wrap sharp edges so that no damage occurs.

Securing load



After loading, secure the ski bag and its contents. Tension the retaining strap on the tensioning buckle for this purpose.

⚠ Secure the ski bag in this way. If you fail to do so, it could endanger occupants during braking or evasive maneuvers. ◀

To store the ski bag, perform the above steps in reverse order.

Inserting ski bag

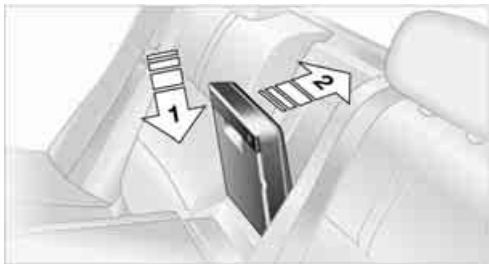

The ski bag is located in the cargo area under the floor cover.

1. Fold down the center armrest and pull off the cover.
2. Remove the tray behind the cover with a screwdriver by applying it at the application point in the center of the tray.
3. Position the ski bag on the lower edge of the opening, refer to arrow 1, then insert it, refer to arrow 2.

Removing ski bag

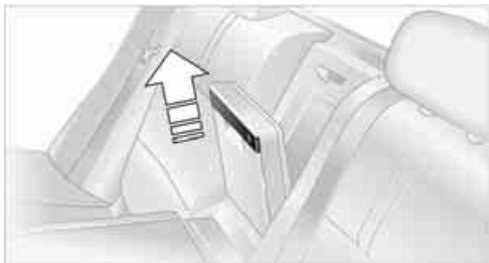

Pull the handle forward and remove the ski bag upward.

 Do not position cargo at the opening. If you do, it can endanger the passengers during braking or evasive maneuvers. ◀

Cargo area

When loading, follow the instructions on page 74.

Folding rear seat back

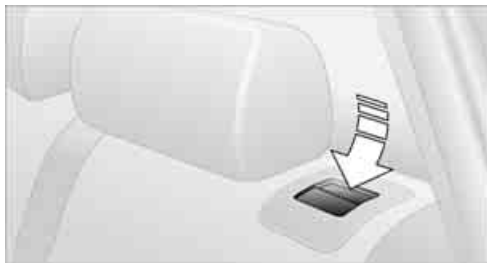

Reach into the opening and pull forward, refer to arrow.

 When you fold back the backrest, be sure that the catch engages securely. Proper engagement causes the red warning field in the recess to disappear. ◀

Ski bag*

To create a flat load area floor, you can remove the ski bag and replace it with a tray before folding the rear backrest forward. The tray is inserted in the same way as inserting the ski bag, refer to Inserting ski bag.

Cargo area cover



Pull the cargo area cover out by the handle and hook it into the rear holders.

You can carry light objects such as articles of clothing on the cargo area cover.

⚠ Do not place heavy and hard objects on the cover. If you do so, they could endanger occupants during braking maneuvers. Do not allow the cover to snap back into place, as otherwise it could be damaged. ◀

Removal

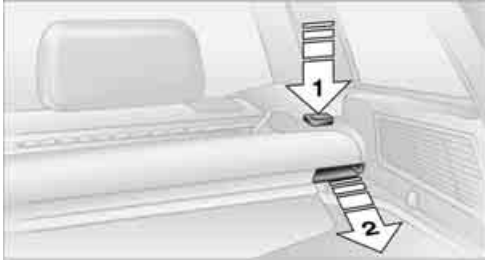

1. Press the side buttons, refer to arrow 1.
2. Pull the cassette towards the rear, refer to arrow 2.

Installation

Push the cassette forward into the two side holders until it locks in place.

Stowing* when rear seat back is folded down



Holders for the cassette are fitted to the backs of the rear seat backs, refer to arrows 1.

Guide in the cassette from the right side until it locks in place, refer to arrow 2. Here, the cargo area cover must always point in the direction of travel and the loop of the partition net must point upward.

You can pull out the partition net and insert it in the holders in the roof area above.

Partition net*

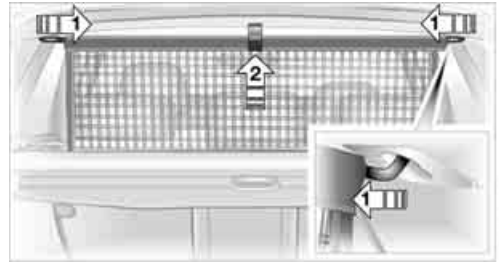

Hooking partition net into place

Pull the partition net out of the cassette by the strap. Push together the bar on both sides, refer to arrows 1, and insert in the brackets. Then press the bar all the way upward in the middle, refer to arrow 2, so that it engages in the brackets.

Letting down partition net

Grasp bar on one side on the partition net, press upward and push together, then release from the brackets.

⚠ Do not allow the partition net to snap back into place, as otherwise there is a danger of injury and the partition net could be damaged. ◀

Behind side trim panel

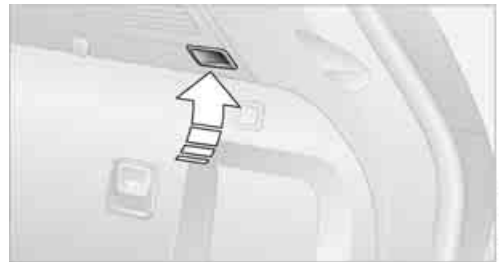

Press the button to open.

Floor cover

Opening

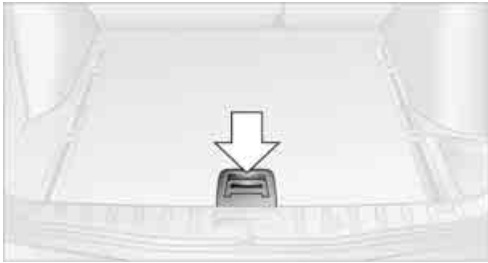

For access to the jack etc.
To open, raise the cover by the handle, refer to arrow.
If required, you can remove or raise the floor cover.

Raising

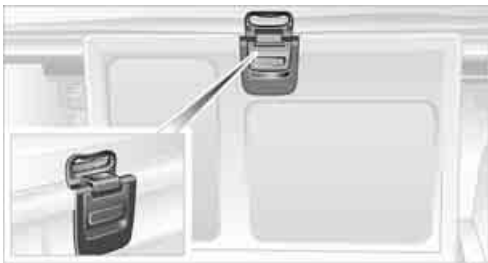

Swing up the floor cover and hook it onto the handle of the cargo area cover by its catch.

Lashing eyes, rail*



You can secure load-securing devices to the lashing eyes on the cargo area floor.

The lashing eyes are located in the cargo area under the floor cover. They can be inserted at the openings in the rails. To slide the lashing eyes, press the button.

 Read and comply with the information enclosed with the load-securing devices. ◀

Power socket



Access to power socket:
Fold the cover upward.

The socket can be used to plug in hand flashlights, car vacuum cleaners etc., with power ratings of up to approx. 200 W at 12 V. Do not damage the socket with unsuitable plugs, also refer to page 65.



Driving tips

This section is designed to provide you with extra support by supplying information useful in dealing with specific driving and operating conditions.

Things to remember when driving

Breaking-in

Moving parts should be allowed to adjust to one another. To ensure that your vehicle provides maximum economy throughout a long service life, we request that you observe the following instructions.

Engine and differential

Up to 1,200 miles/2,000 km:

Drive at varying engine and driving speeds, however do not exceed 4,500 rpm or 100 mph/160 km/h in the process:

Always obey all official speed limits.

Refrain from using full throttle and avoid pressing the accelerator beyond the kick-down point.

Once you have driven 1,200 miles/2,000 km, the engine and vehicle speeds can be gradually increased.

Tires

Due to technical factors associated with their manufacture, tires do not achieve their full traction potential until after an initial break-in period. For this reason, drive with extra care during the initial 200 miles/300 km.

Obey your local and state maximum speed limits.

 When the vehicle is operated on wet or slushy roads, a wedge of water may form between the tire and the road surface. This phenomenon is referred to as hydroplaning and can lead to partial or complete loss of traction, vehicle control and braking effectiveness. Reduce your speed on wet roads. ◀

Brake system

Approx. 300 miles/500 km must elapse before the brake pads and rotors achieve the optimal pad-surface and wear patterns required for trouble-free operation and long service life later on.

To break in the separate handbrake drums, apply the handbrake lightly when coasting to a stop – at a traffic signal, for instance; use caution to avoid posing a danger to other road users.

To avoid corrosion, repeat this procedure from time to time.

The brake lamps do not come on when the handbrake is applied.

 Vacuum for the brake system servo unit on your BMW is available only when the engine is running. When you move the vehicle with the engine off – e.g. by towing – substantially higher levels of pedal force will be required to brake the vehicle. ◀

Clutch

The function of the clutch is also only at its optimized level after a distance driven of approx. 300 miles/500 km. During this break-in period, engage the clutch gently.

Following component replacements

Observe the break-in instructions again if previously addressed components must be replaced again during driving later.

General driving notes

Closing tailgate

 Operate the vehicle only when the tailgate is completely closed, as otherwise exhaust fumes could enter the interior of the vehicle. ◀

If special circumstances should make it absolutely necessary to operate the vehicle with the tailgate open:

1. Close all windows and the panorama glass sunroof.
2. Greatly increase the air supply of the air conditioner or automatic climate control, refer to page 56 or 59.

Hot exhaust system

! As in all vehicles equipped with a catalytic converter, extremely high temperatures are generated in this vehicle. Do not remove the heat shields installed adjacent to various sections of the exhaust system, and never apply undercoating to them. When driving, standing at idle and while parking take care to avoid possible contact between the hot exhaust system and any highly flammable materials such as hay, leaves, grass, etc. Such contact could lead to a fire, resulting in serious personal injury and property damage. ◀

Mobile communications devices in vehicle

! BMW does not recommend using mobile communications devices, e.g. portable phones, in the interior of the vehicle without a direct connection to an outside antenna. Otherwise the vehicle electronics and mobile communications device can affect each other. In addition, there is no assurance that the radiation which results during transmission will be dissipated from the vehicle interior. ◀

Inside rearview mirror, automatically dimming*



The inside rearview mirror contains two photocells that control the automatic dimming function. One is integrated into the mirror glass, the other is located on the back of the mirror.

For trouble-free operation, keep the photocells clean and do not cover the area between the interior rearview mirror and the windshield. Do not attach any kind of stickers on the windshield in front of the mirror, either.

When the vehicle is parked

Condensation forms in the air conditioner system during operation, and then exits under the vehicle. Traces of condensed water under the vehicle are thus normal.

Before driving into a car wash

Fold in the exterior mirrors, refer to page 28, as otherwise they could be damaged due to the width of the vehicle.

Deactivate the rain sensor as otherwise damage could result from undesired wiper activation, refer to page 39.

Hydroplaning

! When driving on wet or slushy roads, reduce road speed. If you do not, a wedge of water can form between tires and road surface. This phenomenon is referred to as hydroplaning, and is characterized by a partial or complete loss of contact between tires and road surface, ultimately undermining your ability to steer and brake the vehicle. ◀

Driving through water

! Do not drive through water on the road if it is deeper than 20 in/50 cm, and then only at walking speed. Otherwise, the vehicle's engine, the electrical systems and the transmission may be damaged. ◀

Use handbrake on inclines

! Do not hold the vehicle in place on slopes by slipping or riding the clutch, use the handbrake instead. Otherwise greater clutch wear will result. ◀

Safe braking

Your BMW is equipped with ABS as standard equipment. The best way to brake is to apply maximum pressure to the brake pedal during emergency: panic braking. Since the vehicle maintains steering responsiveness, you can nevertheless avoid possible obstacles with a minimum of steering effort.

Pulsation at the brake pedal combined with sounds from the hydraulic circuits indicates to the driver that ABS is in its active mode.

Wet roads

While driving in wet conditions and in heavy rain, it is a good idea to apply light pressure to the brake pedal every few miles. Watch traffic conditions to ensure that this maneuver does not endanger other road users. The heat which is generated by the brake applications helps to dry the brake pads and rotors. The full braking force will then be available when you need it.

Hills

 To prevent overheating and reduced efficiency of the brake system, drive long or steep downhill gradients in the gear in which the least braking is required. Otherwise, even light but consistent pedal pressure can lead to high temperatures, brake wear and possibly even brake failure. ◀

You can further enhance the engine's braking effect by selecting a lower gear in the automatic transmission's manual mode, downshifting as far as first gear on extremely steep stretches, refer to page 37. This strategy helps you avoid placing excessive loads on the brake system. During slower downhill driving, use the HDC Hill Descent Control, refer to page 48.

 Never drive with the clutch engaged, the transmission in Neutral or with the engine switched off, as otherwise there is no engine braking when the transmission is in neutral, and no power-assist for brakes and steering with the engine switched off.

Never allow floor mats, carpets or other objects to protrude into the area around the brake or accelerator pedals and obstruct their movement. ◀

Corrosion on brake rotors

When the vehicle is driven only occasionally, during extended periods when the vehicle is not used at all, and in operating conditions where brake applications are less frequent, there is an increased tendency for corrosion to form on rotors, while contaminants accumulate on the brake pads. This occurs because the minimal pressure which must be exerted by the pads during brake applications to clean the rotors is not reached.

Should corrosion form on the brake rotors, the brakes will tend to respond with a pulsating effect that even extended application will fail to cure.

Cargo loading

 To avoid loading the tires beyond their approved carrying capacity, never overload the vehicle. Overloading can lead to overheating and increases the rate at which damage develops inside the tires. The ultimate result can assume the form of a sudden air loss. ◀

Determining load limit



1. Locate the following statement on your vehicle's placard*:

 The combined weight of occupants and cargo should never exceed XXX lbs. or YYY kg, as otherwise the vehicle may be damaged and unstable driving conditions may result. ◀

2. Determine the combined weight of the driver and passengers that will be riding in your vehicle.

3. Subtract the combined weight of the driver and passengers from XXX lbs. or YYY kg.
4. The resulting figure equals the available amount of cargo and luggage load capacity. For example, if the XXX amount equals 990 lbs. and there will be five 150-lbs. passengers in your vehicle, the amount of available cargo and luggage load capacity is 240 lbs.:
990 lbs. minus 750 lbs. = 240 lbs.
5. Determine the combined weight of luggage and cargo being loaded on the vehicle. That weight may not safely exceed the available cargo and luggage load capacity calculated in step 4.
6. If your vehicle will be towing a trailer, part of the load from your trailer will be transferred to your vehicle. Consult the manual for transporting a trailer to determine how this may reduce the available cargo and luggage load capacity of your vehicle.

Load

The permitted load is the total of the weight of occupants and cargo/luggage. The greater the weight of occupants, the less cargo/luggage can be transported.

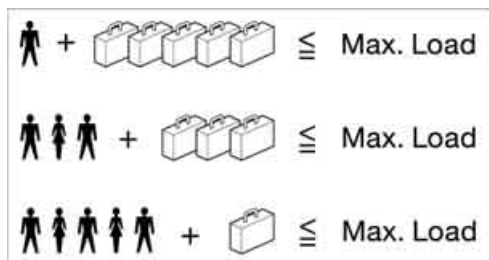

Stowing cargo

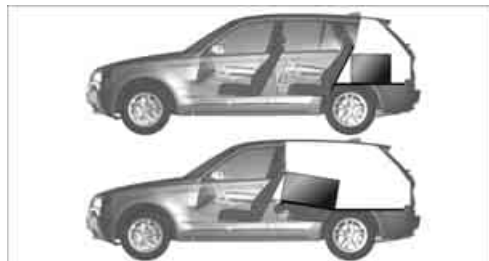

- ▷ Load heavy cargo as far forward and as low as possible, placing it directly behind the bulkhead behind the rear seats.
- ▷ Cover sharp edges and corners.
- ▷ Pull out the partition net, refer to page 68, making sure that objects cannot penetrate the partition net.
- ▷ Do not stack cargo higher than the upper edge of the backrests.
- ▷ Items that could bump against the rear window while driving must be adequately covered.



- ▷ For very heavy cargo when the rear seat is not occupied, secure each safety belt in the opposite buckle.

Securing cargo

- ▷ Use the luggage net* to hold down small and lightweight luggage and cargo, refer to page 68.
- ▷ For larger and heavier pieces, heavy-duty cargo straps* are available from your BMW Sports Activity Vehicle Center. Lashing eyes for attaching these heavy-duty cargo straps have been provided in your vehicle's cargo area, refer to page 69.

- ▷ Read and comply with the information enclosed with the heavy-duty cargo straps.

 Always position and secure the load as described above. If you do not, it can even endanger the passengers during braking or evasive maneuvers.

Never exceed either the approved gross vehicle weight or either of the approved axle loads, refer to page 112, as excessive loads can pose a safety hazard, and may also place you in violation of freeway safety laws.

You should never transport heavy or hard objects unsecured in the passenger compartment, as they could fly around and pose a safety hazard to the vehicle's occupants during abrupt braking or evasive maneuvers. ◀

Roof-mounted luggage rack*

A special rack system is available as a optional accessory for your BMW. Please observe the information contained in the installation instructions.

Loading luggage rack

Because roof racks raise the vehicle's center of gravity when loaded, they have a major effect on its handling and steering response. You should therefore always remember not to exceed the approved roof weight, the approved gross vehicle weight or the axle loads when loading the rack.

You can find the specified weights in the Technical data section on page 112.

Make sure that the load is evenly distributed, and that it does not extend outward to beyond the limits of the loading surface. Always load the heaviest pieces first – on the bottom. Be sure that adequate clearance is maintained for raising the glass sunroof, and that objects do not project into the opening path of the tailgate.

Secure roof-mounted cargo correctly and securely to prevent it from shifting or being lost during the trip.

Drive smoothly. Avoid sudden acceleration and braking maneuvers. Take corners gently.

Driving on poor roads

Your X3 is at home on all paved and unpaved roads. It combines all-wheel drive with the advantages of a normal passenger car.

 Driving on unpaved terrain can cause damage to the vehicle. ◀

When you are driving on poor roads, there are a few points which you should strictly observe – for your own safety, for that of your passengers, and for the safety of the vehicle:

- ▷ Familiarize yourself with the vehicle before you begin driving. Do not take risks with the vehicle under any circumstances.
- ▷ Always adapt the driving speed to the road conditions. The more steep and uneven the roadway is, the lower the speed should be.
- ▷ You can operate your vehicle on uphill and downhill gradients with a maximum slope of 50%. If you wish to drive on uphill and downhill grades of this nature, make sure beforehand that the engine oil and coolant levels are near the MAX mark, refer to pages 90 and 91.
- ▷ For very steep downhill driving, use HDC Hill Descent Control, refer to page 48. It is possible to start off on upward inclines of up to 32%.
The permitted side tilt is 32%.
- ▷ While driving, watch carefully for obstacles such as rocks or holes. Try to avoid these obstacles whenever possible.
- ▷ Avoid that the body makes contact with the ground, e.g. on the crests of hills and bumpy roads. The ground clearance of the vehicle is a maximum of approx. 8.0 in/20 cm. Please be aware that the ground clearance can vary depending on the load and operating conditions of the vehicle.
- ▷ Do not drive in water that is deeper than 20 in/50 cm. If you must drive through water up to that depth, drive at a walking speed and do not stop.
After leaving the water, press on the foot-brake gently several times while driving at a low speed. The brake applications will help

to dry the brakes, thus preventing a reduction in braking performance caused by the moisture.

For cleaning the handbrake, apply the lever slightly at approx. 25 mph/40 km/h and continue to drive for approx. 200 yards/200 meters, provided that traffic conditions allow you to do so.

Please bear the following points in mind after driving on poor roads, in order to preserve the road safety of your BMW:

- ▷ Clean the heavy dirt from the body.
- ▷ Clean mud, snow, ice and other materials from the wheels and tires. Check the tires for damage.





Mobility

This section helps you maintain your mobility by supplying important information on vital topics including fuels and lubricants, wheels and tires, service, maintenance and breakdown assistance.

Refueling

Fuel filler door

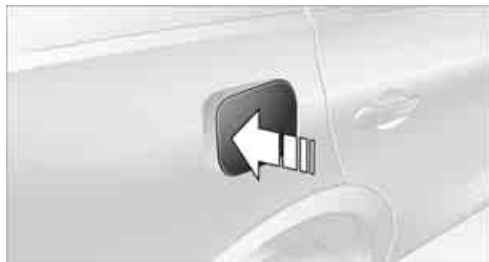

⚠ Always switch off the engine before refueling, as it is not possible to add fuel with the engine running, and attempts to do so may also trigger the Service Engine Soon lamp. ◀

To open and close: press the rear edge of the fuel filler door.

Manual release



In the event of an electrical malfunction in the system, you can release the fuel filler door manually:

1. Open the cover flap in the cargo area on the right-hand side panel, refer to page 68.
2. Pull the green button.

⚠ Always observe all applicable precautions and regulations when handling fuels. Never carry spare fuel containers in your vehicle. Whether empty or full, these containers can leak, cause an explosion, and lead to fire in the event of a collision. ◀

Observe the following when refueling

⚠ When handling fuels, comply with all of the applicable safety precautions posted at the service station. ◀



Put the filler cap in the bracket attached to the fuel filler door.

When refueling, insert the filler nozzle completely into the filler pipe. Lifting the filler nozzle during refueling

- ▷ results in premature pump shutoff
- ▷ can lead to reduced efficiency in the fuel-vapor recovery system

The fuel tank is full when the filler nozzle clicks off the first time.

Closing fuel filler cap

Fit the cap and turn it clockwise until you clearly hear a click.

⚠ Close the filler cap carefully after refueling until a click is heard. While closing, be sure not to squeeze the strap which is fastened to the cap. A loose or missing cap will activate the Check gas cap lamp*. ◀



The warning lamp* lights up. The fuel filler cap is not properly closed or is missing. Check whether the fuel filler cap is properly closed.

Fuel tank capacity

Approx. 17.7 gallons/67 liters, including the reserve capacity of approx. 2 gallons/8 liters.

 Never attempt to continue driving until the tank is completely empty, as engine functions could be affected, and the vehicle could sustain damage as a result. ◀

Fuel specifications

The engine uses unleaded gasoline only.

Required fuel

Premium unleaded gasoline, minimum octane rating: 91.

Minimum octane rating corresponds to the Anti Knock Index AKI and is determined to the so-called (R+M)/2 method.

 Do not use leaded gasoline, as otherwise the lambda probe and catalytic converter will be permanently damaged. ◀

Use high-quality brands

Field experience has indicated significant differences in fuel quality: volatility, composition, additives, etc., among gasolines offered for sale in the United States and Canada. Fuels containing up to and including 10% ethanol or other oxygenates with up to 2.8% oxygen by weight, that is, 15% MTBE or 3% methanol plus an equivalent amount of co-solvent, will not void the applicable warranties with respect to defects in materials or workmanship.

 The use of poor-quality fuels may result in drivability, starting and stalling problems especially under certain environmental conditions such as high ambient temperature and high altitude.

Should you encounter drivability problems which you suspect could be related to the fuel you are using, we recommend that you respond by switching to a recognized high-quality brand. Failure to comply with these recommendations may also result in unscheduled maintenance. ◀

Wheels and tires

Tire inflation pressure

Information for your safety

It is not merely the tire's service life, but also driving comfort and – to a great extent – driving safety that depend on the condition of the tires and the maintenance of the specified tire pressure.

Checking pressure

Only check tire inflation pressure when the tires are cold, i.e. after a maximum of 1.25 miles/2 km driving or when the vehicle has been parked for at least 2 hours. When tires are warm, the tire inflation pressure increases.

 Check the tire inflation pressure regularly and correct it if necessary, including compact wheel: at least every two weeks and before beginning a longer trip. If you fail to observe this precaution you may be driving on tires with incorrect tire pressures, a condition that can not only compromise your vehicle's driving stability, but also lead to tire damage and the risk of an accident. Do not drive with a depressurized, i.e. flat tire. A flat tire will seriously impair your vehicle's handling and braking response. Attempts to drive on a flat tire can lead to loss of control over the vehicle. ◀

 After correcting the inflation pressure(s), always reinitialize the Flat Tire Monitor, refer to page 50. ◀

Inflation pressures for factory-installed tires



The inflation pressures for your factory-installed tires can be found on the door jamb when you open the driver's door.

Inflation pressures for other tire sizes



The table below provides all the correct inflation pressures for the specified tire sizes at ambient temperature.

 For correct identification of the right tire inflation pressure for your tires, observe the specifications for the corresponding tire sizes. ◀

Tire size

The inflation pressures apply to the tire sizes approved and tire brands recommended by BMW; a list of these is available from your BMW Sports Activity Vehicle Center.

X3 2.5i/3.0i

Tire size	Pressure specifications in psi/kPa			
	max. 			
235/55 R 17 99 H M+S 235/55 R 17 99 Q, T, H M+S	29/200	32/220	32/220	38/260
215/60 R 17 96 H M+S 215/60 R 17 96 Q, T, H M+S 235/50 R 18 97 H M+S 235/50 R 18 97 V	32/220	35/240	35/240	41/280
Front: 235/50 R 18 97 V	32/220	–	35/240	–
Rear: 255/45 R 18 99 V	–	32/220	–	38/260
Front: 235/45 R 19 95W	32/220	–	35/240	–
Rear: 255/40 R 19 96W	–	35/240	–	41/280
Compact wheel: T 135/90 R 17 104 M	61/420			

More details on the permitted load and weights can be found on page [112](#)

Tire identification marks

Knowledge of the labeling on the side of the tire makes it easier to identify and choose the right tires.

Tire size

e.g. 235/50 R 18 97 V

Nominal width in mm _____

Cross-sectional relationship in % _____

Radial tire code _____

Rim diameter in inches _____

Load rating, not for ZR tires _____

Speed rating, before R on ZR tires _____

Speed code letter

- Q = up to 105 mph/160 km/h
- T = up to 118 mph/190 km/h
- H = up to 131 mph/210 km/h
- V = up to 150 mph/240 km/h
- W = up to 167 mph/270 km/h
- Y = up to 186 mph/300 km/h

Tire Identification Number

Tires with DOT codes meet the guidelines of the U.S. Department of Transport.

DOT code:

e.g. DOT xxxx xxx 3603

Manufacturer code for tire make _____

Tire size and tire design _____

Tire age _____

Tire age

The tire's date of manufacture is indicated on the sidewall:
 DOT ... 3004 indicates that a tire was manufactured in week 30 of the year 2004.

BMW recommends that you replace all tires after 6 years at most, even if some tires may last for 10 years.

Uniform Tire Quality Grading

Quality grades can be found where applicable on the tire sidewall between tread shoulder and maximum section width.

For example:

Tread wear 200 Traction AA
 Temperature A

DOT Quality Grades

Tread wear
 Traction AA A B C
 Temperature A B C



All passenger car tires must conform to Federal Safety Requirements in addition to these grades. ◀

Tread wear

The tread wear grade is a comparative rating based on the wear rate of the tire when tested under controlled conditions on a specified government test course.

For example, a tire graded 150 would wear one and one-half, 1½, times as well on the government course as a tire graded 100. The relative performance of tires depends upon the actual conditions of their use, however, and may depart significantly from the norm due to variations in driving habits, service practices and differences in road characteristics and climate.

Traction

The traction grades, from highest to lowest, are AA, A, B, and C.

Those grades represent the tire's ability to stop on wet pavement as measured under controlled conditions on specified government test surfaces of asphalt and concrete. A tire marked C may have poor traction performance.



The traction grade assigned to this tire is based on straight-ahead braking traction tests, and does not include acceleration, cornering, hydroplaning, or peak traction characteristics. ◀

Temperature

The temperature grades are A, the highest, B and C, representing the tire's resistance to the generation of heat and its ability to dissipate heat when tested under controlled conditions on a specified indoor laboratory test wheel. Sustained high temperature can cause the material of the tire to degenerate and reduce tire life, and excessive temperature can lead to sudden tire failure. The grade C corresponds to a level of performance which all passenger car tires must meet under the Federal Motor Vehicle Safety Standard No. 109. Grades B and A represent higher levels of performance on the laboratory test wheel than the minimum required by law.

 The temperature grade for this tire is established for a tire that is properly inflated and not overloaded. Excessive speed, underinflation, or excessive loading, either separately or in combination, can cause heat buildup and possible tire failure. ◀

M+S

Winter and all-season tires. These have better winter properties than summer tires.

Tire condition

Inspect your tires frequently for tread wear, signs of damage and for foreign objects lodged in the tread. Check the tread pattern depth.

Tire tread

The tread depth should not drop below 0.12 in/3 mm, although, for example, European legislation only specifies a minimum tread depth of 0.063 in/1.6 mm.

At tread depths below 0.12 in/3 mm, there is an increased risk of high-speed hydroplaning, even when only small amounts of water are present on the road surface. As winter tires display a noticeable loss in their ability to cope with cold-weather driving conditions once the tread wears to below 0.16 in/4 mm, to ensure contin-

ued safety you should always have such tires replaced.

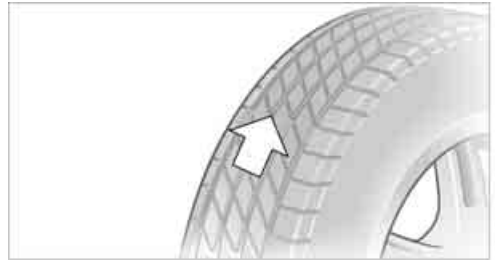

Wear indicators at the tread-groove base, refer to arrow, are distributed over the tire's circumference and are marked on the side of the tire with TWI – Tread Wear Indicator. At a tread depth of 0.063 in/1.6 mm these indicators, signal that the tires have reached the legally permissible wear limit.

Wheel/tire damage

 Due to low-profile tires, please note that wheels, tires and suspension parts are more susceptible to road hazard and consequential damages. ◀

Unusual vibrations encountered during normal vehicle operation can indicate tire failure or some other vehicle defect. This can, for example, be caused by driving over curbs. These kinds of problems may also be signaled by other changes in vehicle response, such as a strong tendency to pull to the left or right.

 In these cases reduce speed immediately. Drive carefully to the next BMW Sports Activity Vehicle Center or tire dealer, or have the vehicle towed to one of these locations if necessary.

Tire damage, extending to sudden and complete loss of pressure in extreme cases, can pose a potentially lethal safety hazard for the vehicle's occupants and other road users alike. ◀

New wheels and tires

 Have new wheels and tires installed only by your BMW Sports Activity Vehicle Center or tire shop that works according to BMW repair procedures with correspondingly trained personnel. If this work is not carried out properly, there is a danger of subsequent damage and related safety hazards. ◀

Retreaded tires

 BMW does not recommend the use of retreaded tires, as otherwise driving safety may be reduced. The causes for this include the possibly different tire casing structures and the often wide variations in their age, which can result in a limited service life. ◀

The right wheels and tires

 BMW recommends that you use only wheel and tire combinations that BMW has tested and approved for your particular vehicle. Variations in factors such as manufacturing tolerances mean that even wheels and tires with identical official size ratings could actually have different dimensions than the approved units – these differences could lead to body contact, and with it the risk of severe accidents. If non-approved wheels and tires are used, BMW cannot evaluate their suitability, and therefore cannot be held liable for driving safety. ◀

You can ask your BMW Sports Activity Vehicle Center for the correct wheel-and-tire combination.

The correct wheel-and-tire combination affects various systems whose function would otherwise be impaired, e.g. ABS, DSC or xDrive.

To maintain good handling and vehicle response, use only tires of a single tread configuration from a single manufacturer. After a flat tire, always remember to have the specified wheel-and-tire combination remounted on the vehicle as soon as possible.

Recommended tire sizes and brands

BMW tests certain tire brands for each tire size, classifies them as road-safe and approves them. These are available at a specialized dealer, preferably your BMW Sports Activity Vehicle Center. Observe any country-specific regulations, e.g. on making a corresponding entry in the vehicle documents.

The factory-mounted tires have been specially selected to provide optimized performance when installed on your vehicle; if properly cared for, they will provide a combination of safety and excellent ride comfort.

Special characteristics of winter tires

BMW recommends winter tires for use in cold winter driving conditions. Although all-season M+S tires provide better winter traction than summer tires, they generally fail to provide the same levels of cold-weather performance as winter tires.

Observing speed ratings

 Never exceed the maximum speed for which the winter tires are rated. Unprofessional attempts by laymen to service tires can lead to damage and accidents. Have this work performed by skilled professionals only. The technicians at your BMW Sports Activity Vehicle Center will be glad to assist you with the required professional knowledge and specialized equipment. ◀

Storage

Store wheels or tires in a cool, dry place, protecting them against light whenever possible. Protect the tires against contact with oil, grease and fuel. Do not exceed the maximum tire inflation pressure indicated on the side wall of the tire.

Snow chains*

Only certain snow chains have been tested by BMW and classified and approved as safe. You can obtain a list of these from your BMW Sports Activity Vehicle Center. BMW recommends the use of approved narrow-link snow chains only. These snow chains are approved exclusively for use on summer or winter tires in pairs on the rear wheels.

Observe the manufacturer's instructions when installing snow chains.

Do not exceed a vehicle speed of 30 mph/
50 km/h with snow chains mounted.

Snow chains may not be mounted on the following tires:

- ▷ 255/45 R 18
- ▷ 255/40 R 19



After mounting snow chains, do not initialize the Flat Tire Monitor.

When you are driving with snow chains, it can be beneficial to switch off DSC briefly, refer to page [48](#). ◀

Under the hood

⚠ Never attempt to perform any service or repair operations on your vehicle without the required professional technical training. If you are not familiar with the regulations to be observed, have work on your vehicle carried out only by a BMW Sports Activity Vehicle Center or a workshop that uses personnel trained in accordance with BMW requirements. If this work is not carried out properly, there is a danger of subsequent damage and related safety hazards. ◀

Hood

Unlocking



Pull the lever located under the left side of the instrument cluster.

Opening

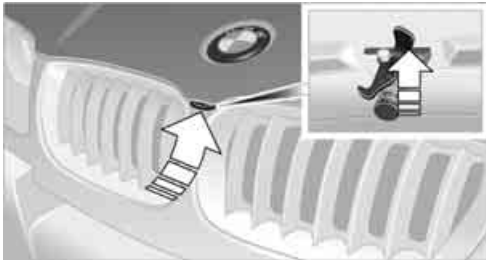

Press the release handle and open the hood.

Closing



Let the hood fall from approx. 1 ft/30 cm so that you hear it engage.

⚠ Observe the same precautions that apply to all closing operations by ensuring that the hood's travel range is clear and unobstructed before allowing the hood to fall into position.

If you see any signs that the hood is not completely closed while driving your vehicle, you should stop at once and close it securely. ◀

Engine compartment

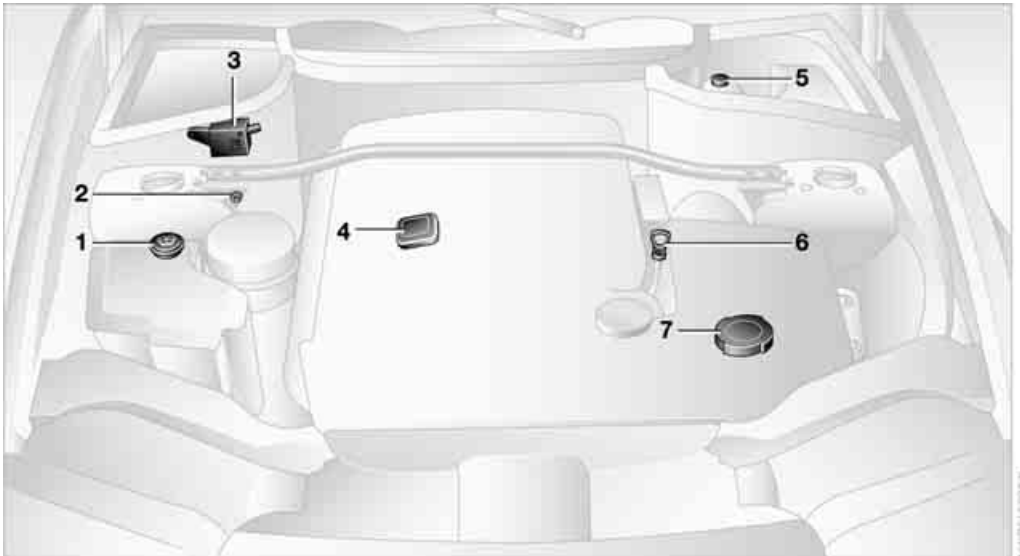

- 1 Reservoir for windshield and headlamp washer system [90](#)
- 2 Body ground: negative terminal [104](#)
- 3 Auxiliary terminal for jump starting [104](#)
- 4 Engine oil filler neck [91](#)
- 5 Brake fluid reservoir [92](#)
- 6 Dipstick for engine oil [90](#)
- 7 Coolant expansion tank [91](#)

Washer fluid

Headlamp* and windshield washer system

 The antifreeze for the washer systems is flammable. For this reason, keep it away from sources of flame and store it only in its original containers. Store it so that it is inaccessible to children. Always observe the instructions for use provided on the containers. ◀

 We recommend that you mix the washer fluid before adding it to the reservoir. ◀



Capacity of the windshield washer system: approx. 3.2 US quarts/3 liters.

Capacity for equipment with headlamp washer system: approx. 6.9 US quarts/6.5 liters.

Fill with water and, if required, with an antifreeze additive according to manufacturer's recommendations.

Engine oil

Engine oil consumption depends on driving style and operating conditions.

Warning lamp

Engine oil pressure

 The warning lamp lights up red: Stop the vehicle immediately and switch off the engine. Check the engine oil level; top off as required. If the oil level is correct: have the system checked immediately.

 Do not continue driving. The engine could be damaged because of inadequate lubrication. ◀

Engine oil level



The warning lamp lights up yellow while driving:

The oil level is at the absolute minimum. Add engine oil as soon as possible. Until then, do not drive more than approx. 30 miles/50 km.



The warning lamp lights up yellow after the engine is switched off:

Top off engine oil at the earliest opportunity, e.g. when refueling.

Engine oil sensor



The warning lamp lights up yellow within 20 seconds after starting the engine:

The oil level sensor is defective. Have checked as soon as possible.

Checking oil level

1. With the engine at operating temperature, i.e. after at least 6 miles/10 km of uninterrupted driving, park the vehicle in a horizontal position.
2. Switch off engine.
3. After approx. 5 minutes, pull the dipstick out and wipe it off with a clean lint-free cloth, paper towel, or similar material.
4. Carefully push the dipstick all the way into the guide tube and pull it out again. The oil should extend to between the two marks on the dipstick.



5. Push the oil dipstick into the dipstick tube as far as possible again.

The oil quantity between the two marks of the dipstick is approx. 1.1 US quarts/1 liter.

 Do not fill beyond the upper mark on the dipstick. Excess oil can damage the engine. ◀

Adding engine oil

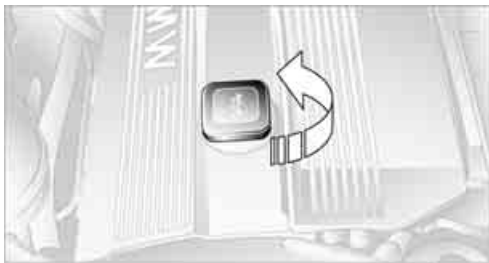

Do not add oil until the oil level has dropped to just above the lower marking on the dipstick, refer to page 90.

 Add oil within the next 30 miles/50 km, otherwise engine damage could result. ◀

 Store oil, grease etc., well out of the reach of children; always observe all warning labels on the containers. ◀

Oil change

Have oil changed only at your BMW Sports Activity Vehicle Center or at a workshop that works according to BMW repair procedures with correspondingly trained personnel.

Approved engine oils

The quality of the engine oil selected has critical significance for the operation and service life of an engine. Based on extensive testing, BMW has approved only certain engine oils.

Use only approved BMW High Performance Synthetic Oil.

If you are unable to obtain BMW High Performance Synthetic Oil, you can add small amounts of another synthetic oil between oil changes. Use only oils with the API SH specification or higher.

 Ask your BMW Sports Activity Vehicle Center for details concerning the specific BMW High Performance Synthetic Oil or synthetic oils which have been approved. ◀

You can also call BMW of North America at 1-800-831-1117 or visit this website: www.bmwusa.com to obtain this information.

 BMW engines are designed to operate without additives, and their use could even lead to damage in some cases. ◀

Viscosity ratings

Viscosity is the oil flow rating as defined in SAE classes.

The selection of the correct SAE class depends on the climate conditions in the area where you typically drive your BMW.

 Approved oils are in SAE classes 5W-40 and 5W-30. ◀

These oils may be used for driving in all ambient temperatures.

Coolant

Warning lamp



The warning lamp lights up: coolant level is too low; top off at the next opportunity.

 Do not open the cooling system when the engine is hot. Escaping coolant can cause burns. ◀

Coolant consists of water and coolant additive. Not all commercially available additives are suitable for your BMW. Ask your BMW Sport Activity Vehicle Center for suitable additives.

 Only use suitable additives, as otherwise engine damage may result. The additives present a health hazard. ◀

 Always observe all applicable environmental laws and regulations when disposing of used coolant additives. ◀

Checking coolant level

1. The engine must be at ambient temperature.
2. Turn the cap of the expansion tank counterclockwise to allow any accumulated pres-

sure to escape, then continue turning to open.

- The coolant level is correct if the upper end of the red float bar is at least at the same height as the top edge of the filler neck, refer to arrow. The bar end may only protrude by a maximum of $\frac{3}{4}$ in/2 cm, i.e. up to the second mark on the float bar, refer also to sketch beside the filler neck.

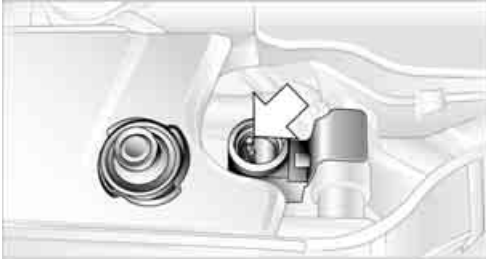

- If the coolant is low, slowly add coolant up to the specified level – do not overfill.
- Screw on the cap and tighten firmly.
- Have the reason for the coolant loss eliminated as soon as possible.

Brake system

Malfunction

Brake fluid

 The warning lamp lights up red despite the handbrake being released:
Stop immediately.

The brake fluid in the reservoir has fallen to below the minimum level. At the same time, a considerably longer brake pedal travel may be noticeable. Have the system checked immediately.

 During continued driving increased brake pedal pressure may be necessary, and considerably longer braking distances may result. Please adapt your driving style accordingly. ◀

 Display of the previously described malfunction on Canadian models.

Brake pads



The warning lamp lights up. The brake pads have reached their minimum pad thickness. Have brake pads replaced immediately.



For your own safety: use only brake pads that BMW has approved for your particular vehicle model. As BMW cannot assess the suitability of other brake pads for use in your vehicle, we are unable to assume continued responsibility for the vehicle's operating safety if non-approved pads are installed. ◀

Maintenance

The BMW maintenance system



The BMW maintenance system supports the preservation of the traffic and operating safety of your BMW.

Regular maintenance is not only required for the safety of the vehicle, it also improves the resale value.

Service Interval Display

The BMW maintenance system takes the driving conditions of the vehicle into account when determining service intervals:

From the point of view of maintenance, 62,000 miles/100,000 km accumulated in short-distance urban driving are not the equivalent of the same distance covered at moderate speeds in long-distance highway travel.

The BMW maintenance system is divided into engine oil service as well as Inspections I and II. Determining the maintenance intervals according to the actual loads on the vehicle covers every kind of operating situation. However, even those who drive only short distances, significantly less than 6,200 miles/10,000 km annually, should have the engine oil changed at least every 2 years since oil deteriorates over time, regardless of use.

 Brake fluid is hygroscopic: it absorbs moisture from the atmosphere over the course of time. To ensure that the brake system continues to provide safe and reliable performance, remember to have the brake fluid

changed at least every two years by a BMW Sports Activity Vehicle Center, also refer to the Service and Warranty Information Booklet for US models or the Warranty and Service Guide Booklet for Canadian models. ◀

Service and Warranty Information Booklet for US models/Warranty and Service Guide Booklet for Canadian models

For detailed information on required maintenance items and the work involved, please refer to the Service and Warranty Information Booklet for US models or to the Warranty and Service Guide Booklet for Canadian models.

Depending on operating conditions, it may be advisable to have the body checked for damage from rocks or gravel as a precaution against corrosion.

 BMW recommends that you have your BMW Sports Activity Vehicle Center perform the maintenance and repair. Check that the maintenance work is recorded in the Service and Warranty Information Booklet for US models or the Warranty and Service Guide Booklet for Canadian models. These entries will serve as proof that the vehicle has received regular maintenance. ◀

OBD connector



The interface socket for the Onboard Diagnostics is located on the left of the driver's side at

the bottom of the instrument cluster and under a cover. The cover has the letters OBD on it.

The most important components for the composition of the emissions can be checked by a device via this interface.



If the Service Engine Soon indicator lamp lights up either continuously or intermittently, this indicates a malfunction in the emissions-related electronic systems. Although the vehicle remains operational, you should have the systems checked by your BMW Sports Activity Vehicle Center at the earliest possible opportunity.

The illuminated indicator informs you of the need for service, not that you need to stop the vehicle. However, the systems should be checked by your BMW Sports Activity Vehicle Center at the next opportunity.

If the indicator blinks or flashes, this indicates a high level of engine misfire. Reduce speed and contact the nearest BMW Sports Activity Vehicle Center immediately. Severe engine misfiring over even a short period of time can seriously damage emission control system components, especially the catalytic converter.



Display of the previously described malfunction on Canadian models.



If the fuel filler cap is not on tight enough, the OBD system can detect leaking vapor and the indicator lamp will light up. If the fuel filler cap is then tightened, the indicator lamp will usually go out after a short period of time. ◀

Event Data Recorders

Your vehicle may be equipped with one or more sensing and diagnostic modules or a recording device capable of recording or transmitting certain vehicle data or information. In addition, if you have a Subscription Service Agreement for the BMW Assist system, certain vehicle information may be transmitted or recorded in order to provide such services.

Care

For all information on this subject, refer to the Caring for your vehicle brochure.

Replacing components

Onboard tool kit

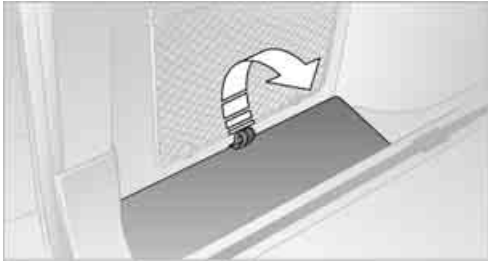

The onboard tool kit is located in a compartment on the left in the cargo area.

Replacing wiper blades

Front



1. Move the wiper into the fold-out position, refer to page 38.
2. Lift the wiper arm and press the securing spring, refer to arrow.
3. Pull the wiper blade off toward the wiper arm.
4. Insert the new blade and snap it into place.

 Fold the wipers back down onto the windshield before you turn the ignition key to position 1 or 2 again. If you do not, they could be damaged. ◀

Rear



1. Lift the wiper arm.
2. Pull off the wiper blade, refer to arrow.
3. Insert a new wiper blade.

Lamps and bulbs

The lamps and bulbs make essential contributions to the safety of your vehicle. Therefore, comply fully with the following instructions during bulb replacement. If you are not familiar with the specified procedures, BMW recommends having the replacements carried out at your BMW Sports Activity Vehicle Center.

 Never touch the glass of new bulbs with your bare fingers, as even minute amounts of contamination will burn into the bulb's surface and reduce its service life. To install, use a clean cloth, napkin etc. or hold the bulb by its metal socket. ◀

A replacement bulb set is available from your BMW Sports Activity Vehicle Center.

 To prevent short circuits, before working on any electrical system, equipment or accessory you should always switch it off and disconnect the cable from the battery's negative terminal before starting.

To avoid possible injury or equipment damage when replacing bulbs, observe any instructions provided by the bulb manufacturer. ◀

 When maintaining the headlamps, please comply with the instructions in the separate Caring for your vehicle brochure. ◀

Halogen low beams

H7 bulb, 55 watts

⚠ Always wear gloves and eye protection – the atmosphere within the bulb is pressurized. Failure to observe this precaution can lead to personal injury should the bulb be damaged. ◀

Driver's side

1. Position the screwdriver from the onboard tool kit and pull off the lamp cover.

⚠ Exercise caution when handling the screwdriver, as otherwise personal injury can occur or the vehicle can be damaged. ◀



2. Press the bulb holder downward and remove.



3. Remove the bulb, install a new bulb.
4. Place the bulb holder with the lower edge against the bracket and press it in until the lamp base locks in place.

Front passenger side



Before replacing the bulb, remove the reservoir for the windshield washing system from the bracket. To do so, loosen the bolt, refer to arrow, and place the reservoir to one side.

⚠ Bear in mind that the windshield washing system reservoir is heavy. If you do not, injuries or damage to the vehicle can occur. ◀

For bulb replacement procedure, refer to Driver's side.

Halogen high beams

H7 bulb, 55 watts

⚠ Always wear gloves and eye protection – the atmosphere within the bulb is pressurized. Failure to observe this precaution can lead to personal injury should the bulb be damaged. ◀

Driver's side

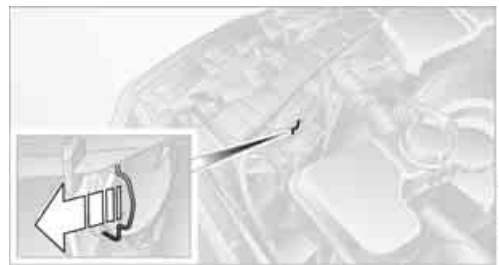

1. Open the clip and remove the lamp cover.
2. Press the bulb holder downward and remove, refer to Low beams.
3. Pull off the lamp base; plug in a new lamp base.

- Place the lamp base with the lower edge against the bracket and press it in until the lamp base locks in place.

 Make sure that the cover does not fall into the engine compartment, as otherwise the vehicle can be damaged or other road users can be endangered. ◀

Front passenger side

Before replacing the bulb, remove the reservoir of the windshield washer system from the bracket, refer to Halogen low beams on page 96.

For bulb replacement procedure, refer to Driver's side.

Xenon lamps*

The service life of these bulbs is very long and the probability of a failure is very low, provided that they are not switched on and off an unusual number of times. If one of these bulbs should nevertheless fail, it is possible to continue driving with great caution using the fog lamps, provided traffic laws in your area do not prohibit this.

 To avoid risk of potentially fatal injuries: owing to the extremely high voltages at which these units operate, service work should always be entrusted to qualified personnel. ◀

Parking and roadside parking lamps

5 Watt bulb

In case of a malfunction, please contact your BMW Sports Activity Vehicle Center.

Turn signal, front



21 watt bulb

Access to the turn signal is at the edge of the lamp unit, refer to arrow.

 Make sure that the lamp base does not fall into the engine compartment, as otherwise the vehicle can be damaged or other road users can be endangered. ◀

- Turn the lamp base and remove it.
- Replace the bulb.
- Insert the lamp base. If it does not snap in place immediately, turn the lamp base until it does.

Side-mounted turn signals

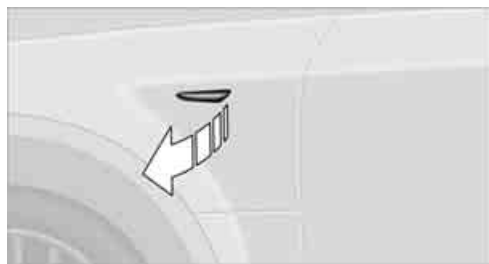

5 Watt bulb

- Use finger pressure against the rear end of the lamp, refer to arrow, to press it forward for removal.
- Apply gentle pressure to the bulb while turning it to the left and pull it out.
- Install in the reverse order.

Front fog lamps

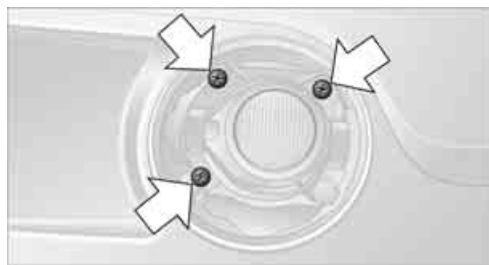

H11 bulb, 55 watts

 Always wear gloves and eye protection – the atmosphere within the bulb is pressurized. Failure to observe this precaution can

lead to personal injury should the bulb be damaged. ◀

1. Pull the cover in front of the fog lamp forward.
2. Loosen the screws, refer to arrow, and pull out the headlamp.
3. Turn the lamp base at the back of the headlamp to the left and remove it.
4. Replace the bulb.

Tail lamps

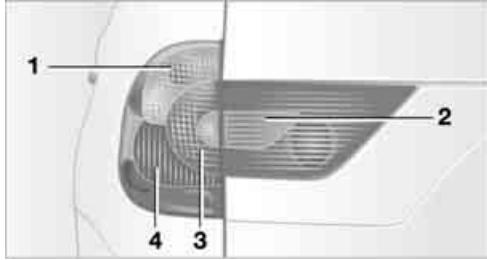

21 watt bulb

- 1 Turn signal
- 2 Backup lamp
- 3 Tail lamp/brake lamp
- 4 Tail lamp/brake lamp*

Replacing tail lamps



1. Open the flap in the side panel, refer to page 68.
2. To release the plug connection of the cable, press the spring, refer to arrow 1.
3. Lift the side panel somewhat.
4. To remove the back panel of the lamp, release the retainer, refer to arrow 2.

5. Apply gentle pressure to the bulb fitting while turning it to the left for removal and replacement.
6. Install in the reverse order.

Lamps in the tailgate

Please contact your BMW Sports Activity Vehicle Center.

License plate lamps



10 watt bulb

1. Press the lamp out to the side with a screwdriver.
2. Remove the lamp and replace the bulb.

Tailgate lamp

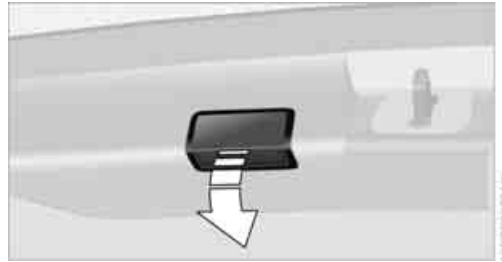

5 Watt bulb

1. Pull off the bulb holder.
2. Replace the bulb.

LEDs light-emitting diodes

Light-emitting diodes installed behind translucent lenses serve as the light source for many of the controls and displays in your vehicle. These light-emitting diodes are related to ordinary lasers.

 Do not remove the covers, and never stare into the unfiltered light for several hours, as irritation of the retina could result. ◀

Changing a wheel

 Safety precautions to observe in the event of a flat tire and during all tire changes:

Park the vehicle as far as possible from passing traffic. Park on a firm, flat, surface. Switch on the hazard warning flashers.

Lock the steering wheel in straight-ahead setting of the wheels. Engage the handbrake and engage first gear, reverse gear or selector-lever setting P.

All passengers should be outside the vehicle and well away from your immediate working area, behind a guardrail, for instance.

If a warning triangle or portable hazard warning lamp is required, set it up on the roadside at an appropriate distance from the rear of the vehicle. Comply with all safety guidelines and regulations.

Change the wheel only on a level, firm surface which is not slippery. The vehicle or the jack could slip to the side if you attempt to raise the vehicle on a soft or slippery surface such as snow, ice, tiles, etc.

Position the jack on a firm support surface.

Do not use a wooden block or similar object as a support base for the jack, as this would prevent it from extending to its full support height and reduce its load-carrying capacity.

To avoid serious or fatal injury: never lie under the vehicle, and never start the engine while it is supported by the jack. ◀

What you will need

Open tailgate and raise or remove floor cover, refer to page 69.

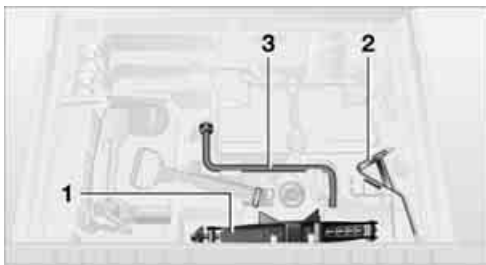

- 1 Vehicle jack
- 2 Chock
- 3 Lug wrench

In order to avoid rattling noises later, note the position of the tools when you remove them and return them to their original position when you are through using them.

Compact wheel

The compact wheel is located under the cargo area on the floor of the vehicle.

1. Unscrew bolt, refer to arrow 1.
2. Fold up lifting handle, refer to arrow 2.

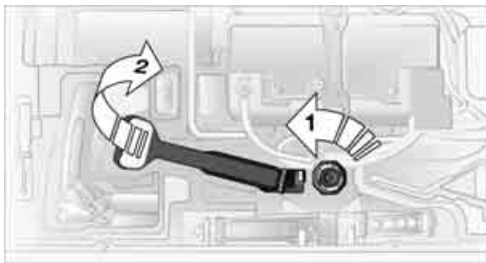

3. Turn the handle to the left as far as possible, refer to arrow 3 on next page.



Turning the handle releases the compact wheel. Weight approx. 18 lbs./ 8 kg. It must be held by the handle. ◀

- Slowly lower the handle as far as possible, refer to arrow 4.



- Take out the compact wheel towards the back.



- Refit the compact wheel holder in reverse order.

⚠ The defective wheel will not fit into the compact wheel holder in place of the compact wheel. ◀

Preparing wheel change

- Observe the safety precautions on page 99.
- Secure the vehicle to prevent it from rolling: Place the wheel chock against the rear surface of the front tire on the side opposite the side being raised. If the vehicle is parked on a downward slope, place the wheel chock securely in front of the tire. If the wheel must be changed on a surface with a more severe slope, take additional precautions to secure the vehicle from rolling.
- Loosen the lug bolts by a ½ turn.

Jacking up vehicle

- Position the vehicle jack at the jacking point closest to the wheel so that the entire surface of the jack base perpendicularly contacts the ground under the jacking point.

⚠ The vehicle jack is designed for changing wheels only. Do not attempt to raise another vehicle model with it or to raise any load of any kind. To do so could cause accidents and personal injury. ◀

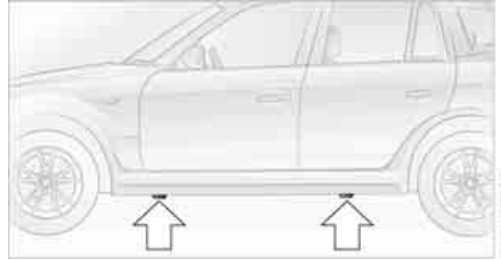

- Guide the jack head into the rectangular recess of the jacking point when cranking up, refer to section of illustration.



- Jack the vehicle up until the wheel you are changing is raised from the ground.

Mounting a wheel

- Unscrew the lug bolts and remove the wheel.
- Remove accumulations of mud or dirt from the mounting surfaces of the wheel and hub. Clean the lug bolts.
- Position the new wheel or compact wheel. Secure the wheel by turning at least two lug bolts into opposite bolt holes. When you mount wheels other than Genuine BMW

light-alloy wheels, different lug bolts may also be required.

4. Screw in the remaining lug bolts. Tighten all the bolts securely in a diagonal pattern.
5. Lower the jack and remove it from beneath the vehicle.

After mounting

1. Tighten the lug bolts in a diagonal pattern.



To ensure safety, always have the lug bolts checked with a calibrated torque wrench as soon as possible to ensure that they are tightened to the specified torque. The tightening torque is 101 lb ft/140 Nm. ◀

2. Stow the defective wheel in the cargo area.
3. Check and correct the tire inflation pressure at the earliest opportunity.



Protect valve stems and valve stem seal caps against dirt and contamination. Dirt in valve stems is a frequent source of gradual air loss. ◀

4. Reinitialize the Flat Tire Monitor, refer to page 49.



Do not initialize the system when driving with the compact wheel. ◀

5. Replace the damaged tire with a new one as soon as possible and have the new wheel balanced.

Driving with compact wheel



Drive reservedly and do not exceed a speed of 50 mph/80 km/h. Do not deactivate DSC, as otherwise unstable driving conditions may result. ◀

The driving characteristics change, for example reduced track stability on braking, extended braking distance, and altered self-steering characteristics in the limit range. In conjunction with winter tires, these characteristics are more pronounced.



Only one compact wheel may be mounted. You should re-equip with wheels and tires of the original size as quickly as possible. ◀

Vehicle battery

Maintenance

The battery is 100% maintenance-free, i.e., the electrolyte will last for the life of the battery when the vehicle is operated in a temperate climate. Your BMW Sports Activity Vehicle Center will be happy to consult you on all questions concerning the battery.

Warning lamp



The warning lamp lights up. The battery is no longer being charged. The alternator V-belt is defective or there is a malfunction in the charge current circuit of the alternator. Have the system checked immediately.



Do not continue driving if the V-belt is defective. The engine could be damaged due to overheating. Moreover, an increased amount of force is required for steering if there is a sharp drop in the onboard supply voltage. ◀

Charging battery

Charge the battery in the vehicle only when the engine is not running. Use the connections provided in the engine compartment. For connections, refer to Jump starting on page 104.

Disposal



Have old batteries disposed of following replacement at your BMW Sports Activity Vehicle Center or bring them to a collection point. Maintain the battery in an upright position for transport and storage. Always secure the battery to prevent it from tipping over during transport. ◀

Power failure

Following a temporary power failure, e.g. in the case of a dead battery, some equipment is subject to restricted use and must be reinitialized. Individual settings are also lost and must be updated again:

- ▷ Panorama glass sunroof
The sunroof can only be raised and must be initialized, refer to page 21.
- ▷ Power windows
The anti-trapping mechanism must be reinitialized, refer to page 20.
- ▷ Seat and mirror memory
The positions must be stored again, refer to page 26.
- ▷ Time
Must be set again, refer to page 43.

Fuses

⚠ Never attempt to repair a blown fuse, and do not replace a defective fuse with a substitute of another color or amperage rating, as this could lead to a circuit overload, ultimately resulting in a fire in the vehicle. ◀

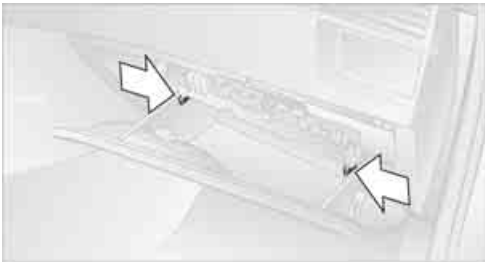

Open the glove compartment and turn the two quick-release fasteners to the left, refer to arrows.

Spare fuses, plastic tweezers, and information about fuse allocation are stored with the fuses.

Giving and receiving assistance

Receiving assistance

The Roadside Assistance of the BMW Group offers you assistance in the event of a breakdown around the clock, as well as on weekends and public holidays.

The phone numbers of the Roadside Assistance control center in your home country can be found in the BMW Dealer directory.

In the case of vehicles with the corresponding equipment, you can use buttons in the headliner to contact Roadside Assistance or initiate an emergency call.

When the emergency call is initiated, a telephone connection is established to the BMW Assist response center.

In vehicles with BMW Assist enabled, if the current location of your vehicle can be determined, it will be transmitted to the BMW Assist response center.

The conditions for initiating an emergency call or contacting Roadside Assistance:

- ▶ Ignition key from position 1
- ▶ The car phone is logged on to a mobile telephone network
- ▶ The emergency call system is operable

Access to buttons*

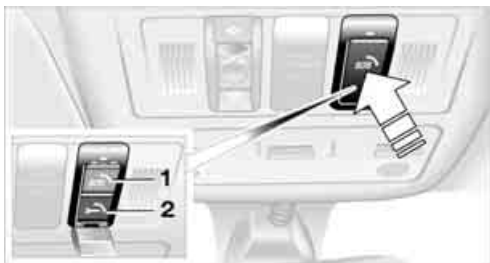

To open the cover:
Briefly press the cover, refer to arrow.

- 1 Emergency call
- 2 Roadside Assistance

Initiating an emergency call*

Press button **1** for at least 2 seconds.

The indicator lamp over the button lights up. As soon as the voice connection to the BMW Assist response center has been established, the indicator lamp flashes.

If the indicator lamp flashes, but you are unable to hear the response center, you can still be heard by the response center.

 For technical reasons, the emergency call cannot be guaranteed under the most unfavorable conditions. ◀

Under certain conditions, an emergency call is initiated automatically immediately after a severe accident. The automatic emergency call is not affected by the button being pressed.

Roadside Assistance*

Press button **2** for at least 2 seconds.

The indicator lamp over the button lights up. As soon as the voice connection to Roadside Assistance has been established, the indicator lamp flashes.

On a country-specific basis, with BMW Assist enabled, the current location of your vehicle is determined at the same time.

Warning triangle*

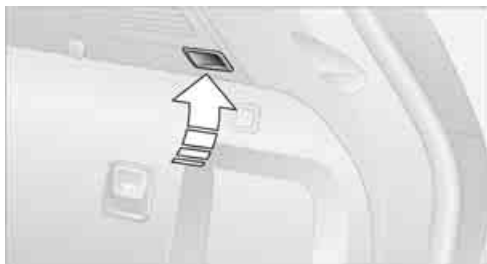

To open the side trim panel: press the button.

 Always observe all legal regulations requiring a warning triangle to be carried in the vehicle. ◀

First-aid kit*

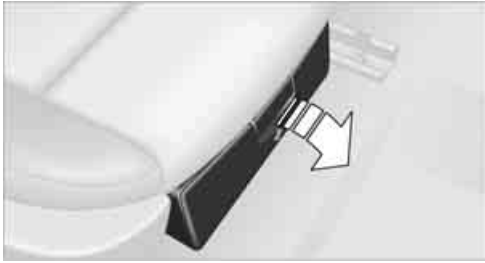

Beneath the front passenger's seat.

To open: pull the handle and fold the cover downward.

To close: fold the cover up.

! Some of the articles in the first-aid kit may be used within a limited time only. Therefore, check the expiration dates of the contents regularly and replace the contents in a timely fashion as needed. You can find replacements in any pharmacy. Always observe all legal regulations requiring a first-aid kit to be carried in the vehicle. ◀

Jump starting

When your battery is discharged, you can use two jumper cables to start your vehicle with power from the battery in a second vehicle. You can also use the same method to help start another vehicle. Use only jumper cables with fully-insulated clamp handles.

! To avoid the risk of potentially fatal injury, always avoid all contact with electrical components while the engine is running. Carefully observe the following instructions to avoid personal injury and/or damage to one or both vehicles. ◀

Preparing

1. Check whether the battery of the other vehicle has a voltage of 12 Volts and approximately the same capacitance in Ah. This information can be found on the battery.

2. Switch off the engine of the vehicle providing assistance.
3. Switch off any electrical systems and components in both vehicles.

! Ensure that no contact exists between the bodywork on the two vehicles, otherwise there is a danger of short circuits. ◀

Connecting jumper cables

! To avoid personal injury from sparks, always follow this sequence when connecting jumper cables. ◀



On your BMW, the auxiliary terminal for jump starting in the engine compartment serves as the battery positive terminal, refer also to engine compartment overview on page 89. The symbol + is embossed on the cover.

1. Open the cover of the BMW auxiliary terminal for jump starting, refer to arrow 1.
2. Connect one terminal clamp of the positive/+ jumper cable to the positive terminal of the battery or an auxiliary terminal of the vehicle providing starting assistance.
3. Connect the second terminal clamp of the positive/+ jumper cable to the positive terminal of the battery or to an auxiliary terminal of the vehicle to be started.

Your BMW has a special nut that serves as the body ground or negative terminal, refer to arrow 2.

4. Attach one end of the jumper cable minus/- to the negative terminal of the battery or to an engine or body ground of the vehicle providing assistance.

5. Connect the second terminal clamp of the negative/- jumper cable to the negative terminal of the battery or to the engine or body ground of the vehicle to be started.

Starting engine

1. Start the assisting vehicle's engine and let it run at an increased idling speed for a few minutes.
2. Start the engine on the other vehicle in the usual way.
If the first start attempt is not successful, wait a few minutes before another attempt in order to allow the discharged battery to recharge.
3. Let the engines run for a few minutes.
4. Disconnect the jumper cables by reversing the connection sequence.

If necessary, have the battery checked and recharged at a BMW Sports Activity Vehicle Center.

 Never use spray fluids to start the engine. ◀

Tow-starting and towing

Use tow fitting

The threaded tow fitting is stored in the onboard tool kit, refer to page 95, and must always remain in the vehicle. It can be screwed in at the front or rear of the BMW.

 To avoid damage to the tow fitting and the vehicle, observe the following: only use the tow fitting that comes with the vehicle and screw it in as far as it will go. Only use the tow fitting to tow on roads. Avoid lateral loading of the tow fitting, e.g. do not lift the vehicle by the tow fitting. ◀

Access to screw thread

Press out the cover in the front or rear bumper at the notch at the bottom with a screwdriver.



Being towed

 Make sure that the ignition key is in position 1, as otherwise the steering lock will engage, making it impossible to steer the vehicle. There is no power assist with the engine stopped. It is then necessary to exert increased effort for braking and steering. ◀

Switch on the hazard warning flashers depending on the local regulations. If the electrical system fails, mark the vehicle to be towed, e.g. with a sign or warning triangle in the rear window.

 Do not exceed a towing speed of 30 mph/ 50 km/h and a towing distance of 95 miles/150 km, as otherwise the drive train may be damaged. ◀

Vehicles with manual transmission

Gear lever in neutral.

Vehicles with automatic transmission

Selector lever in N.

Towing methods

In some countries, towing with tow bars or ropes on public roads is not permitted. Familiarize yourself with the regulations on towing in the respective country.

With tow bar

 The towing vehicle may not be lighter than the vehicle to be towed, as otherwise it will not be possible to control vehicle response. ◀

The tow fittings used should be on the same side on both vehicles. Should it prove impossible to avoid mounting the tow bar at an offset angle, please observe the following:

- ▷ Clearance and maneuvering capability will be strictly limited in corners.
- ▷ When mounted at an angle, the tow bar will exert lateral forces, tending to push the vehicle sideways.

⚠ Secure the tow bar to the tow fitting only. Otherwise damage could result on other vehicle parts. ◀

With tow-rope

When starting off in the towing vehicle, make sure that the tow-rope is taut.

⚠ To avoid jerking and the associated stresses on vehicle components when towing, always use nylon ropes or nylon straps. Secure the tow-rope on the tow fitting only. Otherwise damage could result on other vehicle parts. ◀

With tow truck

⚠ Do not tow the X3 with only the front or rear axle raised, as otherwise the wheels could lock and the transfer case could be damaged. ◀

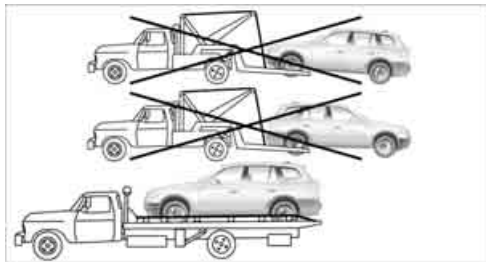

Only have the X3 transported on a load bed.

Tow-starting

▶ Do not tow-start vehicles with an automatic transmission.

Jump starting, refer to page 104. ◀

Vehicles with a catalytic converter should only be tow-started when the engine is cold. It is better to jump start the engine, refer to page 104.

1. Switch on the hazard warning flashers, comply with country-specific regulations.
2. Turn the ignition key to position 2.
3. Engage the 3rd gear.
4. Have the vehicle tow-started with the clutch pedal completely depressed and slowly release the clutch. After the engine starts, immediately depress the clutch pedal completely again.
5. Stop at a suitable location, remove the tow bar or rope and switch off the hazard warning flashers.
6. Have the vehicle checked.

▶ Do not activate the HDC Hill Descent Control during tow-starting, refer to page 48. ◀



Reference

This chapter contains the technical data and the index that will direct you as quickly as possible to the information sought.

Technical data

Engine specifications

		X3 2.5i	X3 3.0i
Displacement	cu in/cm ³	152,2/2,494	181,8/2,979
Number of cylinders		6	6
Maximum output	hp	184	225
at engine speed	rpm	6,000	5,900
Maximum torque	lb-ft/Nm	175/237	214/290
at engine speed	rpm	3,500	3,500

An engine performance test is authorized only on an appropriate chassis dynamometer.

Dimensions

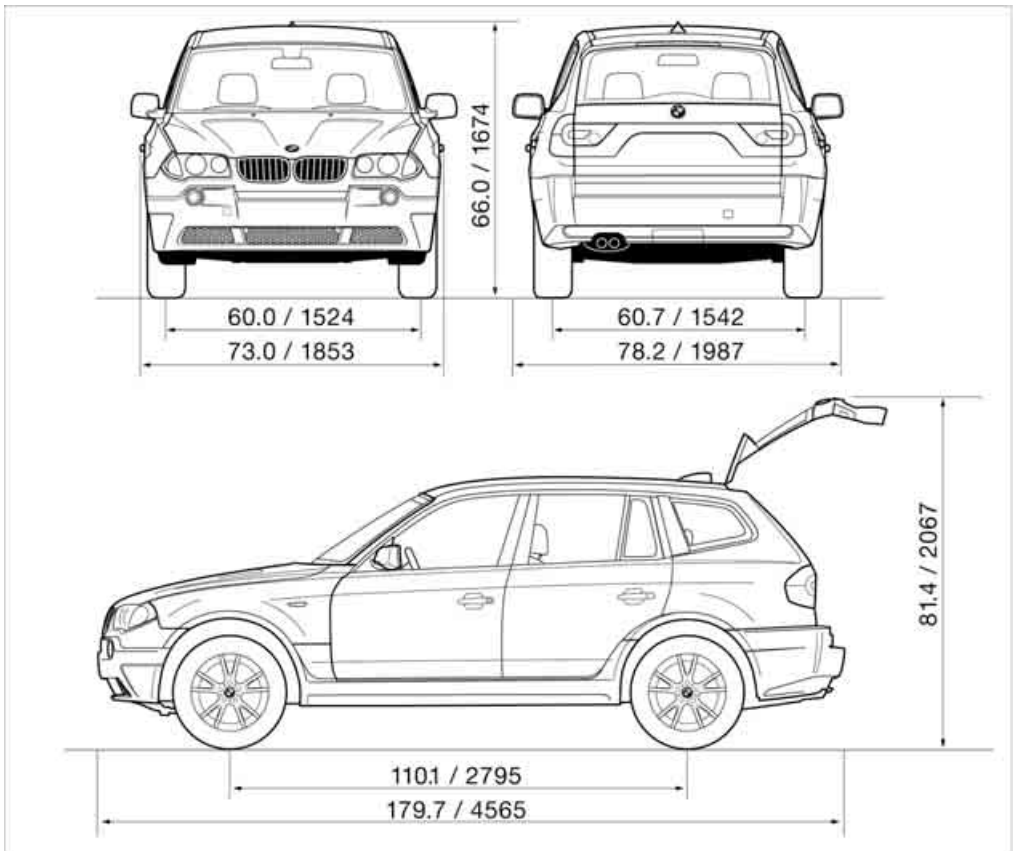

All dimensions in inches/millimeters. Smallest turning circle dia.: 38.4 ft/11.7 m.
Height with roof rack*: 66.0 in/1,674 mm.

Weights

		X3 2.5i	X3 3.0i
Curb weight			
with manual transmission	lbs./kg	4,001/1,815	4,023/1,825
with automatic transmission	lbs./kg	4,045/1,835	4,067/1,845
Approved gross vehicle weight			
with manual transmission	lbs./kg	4,993/2,265	5,049/2,290
with automatic transmission	lbs./kg	5,049/2,290	5,104/2,315
Payload			
with manual transmission	lbs./kg	992/450	1,025/465
with automatic transmission	lbs./kg	1,003/455	1,036/470
Approved front axle load	lbs./kg	2,425/1,100	2,425/1,100
Approved rear axle load	lbs./kg	2,756/1,250	2,778/1,260
Approved roof load capacity	lbs./kg	165/75	165/75
Cargo area capacity	cu ft/l	71/2,011	71/2,011

Never exceed either the approved axle loads or the gross vehicle weight.

Capacities

			Notes
Fuel tank	gal./liters	approx. 17.7/67	Fuel specification: page 81
Reserve	gal./liters	approx. 2/8	
Windshield washer/ headlamp washer system	quarts/liters	approx. 3.2/3.0 approx. 6.9/6.5	For details: page 90
Engine oil and filter change	quarts/liters	approx. 6.6/6.2	For details: page 90

Index

A

ABS Antilock Brake

System [47](#)

– indicator lamp [12](#)

Accessories, refer to For your own safety [6](#)

Accident, refer to Receiving assistance [103](#)

Activated-charcoal filter [61](#)

Adaptive Head Light [53](#)

Adding engine oil [91](#)

Adjusting seats [24](#)

– electric [26](#)

– mechanical [25](#)

– mechanical, sports seat [25](#)

Air, drying, refer to Air conditioner [57](#), [60](#)

Airbags [51](#)

– deactivating front passenger side [31](#), [52](#)

– indicator lamp for front passenger airbags [52](#)

– sitting safely [24](#)

– warning lamp [52](#)

Air circulation, refer to Recirculated-air mode [57](#), [60](#)

Air conditioner [56](#), [57](#)

Air distribution

– air conditioner [57](#)

– automatic climate control [60](#)

Airing, refer to

Ventilation [57](#), [61](#)

Air outlets, refer to

Ventilation [57](#), [61](#)

Air pressure, refer to Tire inflation pressure [82](#)

Air supply

– air conditioner [57](#)

– automatic climate control [60](#)

Air vents, refer to

Ventilation [57](#), [61](#)

AKI, refer to Fuel specifications [81](#)

Alarm system [22](#)

– avoiding unintentional alarms [23](#)

All-season tires, refer to Special characteristics of

winter tires [86](#)

Anchorage points [33](#)

Antifreeze

– coolant [91](#)

– washer fluid [90](#)

Antilock Brake System

ABS [47](#)

– indicator lamp [12](#)

Anti-theft alarm system [16](#)

– refer to Alarm system [22](#)

Anti-trapping mechanism

– panorama glass sunroof [21](#)

– power windows [20](#)

Approved axle load, refer to

Weights [112](#)

Approved engine oils [91](#)

Approved gross vehicle

weight, refer to Weights [112](#)

Armrest

– front [64](#)

– rear [64](#)

Artificial leather, refer to the

Caring for your vehicle

brochure

Ashtray [65](#)

AUC Automatic recirculated-

air control [60](#)

Automatic

– air distribution [60](#)

– air supply [60](#)

– climate control [59](#), [60](#)

– headlamp control [53](#)

– recirculated-air control

AUC [60](#)

Automatic car wash, refer to the Caring for your vehicle brochure

Automatic cruise control [40](#)

Automatic curb monitor [29](#)

Automatic transmission with

Steptronic [36](#)

– indicator lamp [38](#)

– interlock [34](#)

– selector lever interlock [37](#)

– shiftlock [37](#)

– towing [105](#)

– tow-starting [106](#)

AUTO program, refer to

Automatic air distribution

and supply [60](#)

Average fuel consumption [44](#)

– setting units [44](#)

Average speed [45](#)

– setting units [44](#)

Avoiding unintentional alarms [23](#)

Axle loads, refer to

Weights [112](#)

B

Backrest, refer to Seats [25](#)

Backup lamps [36](#)

– refer to Tail lamps [98](#)

– replacing bulbs [98](#)

Bandages, refer to First-aid kit [104](#)

Bar, towing [105](#)

Battery [101](#)

– indicator lamp [12](#)

– jump starting [104](#)

– power failure [102](#)

– remote control [16](#)

– warning lamp [101](#)

Belts, refer to Safety belts [27](#)

Beverage holder, refer to Cup holders [63](#)

Black ice, refer to Ice warning [44](#)

Blower

- air conditioner [57](#)
- automatic climate control [60](#)

BMW maintenance system [93](#)

Bottle holder, refer to Cup holders [63](#)

Brake fluid [92](#)

- level [92](#)
- warning lamp [92](#)

Brake Force Display [50](#)

Brake lamps

- Brake Force Display [50](#)
- indicator lamp, defective lamp [12](#), [53](#)
- replacing bulbs [98](#)

Brake pads

- breaking-in [72](#)

Brake pedal, refer to Safe braking [73](#)

Brake rotors

- brake system [72](#)
- breaking-in [72](#)

Brakes [73](#), [92](#)

- ABS [73](#)
- brake fluid [92](#)
- breaking in [72](#)
- handbrake [35](#)
- indicator/warning lamp [11](#)

Brake system [92](#)

- brake fluid [92](#)
- brake pads [92](#)
- breaking-in [72](#)
- disc brakes [74](#)
- warning lamp [92](#)

Brake wear warning

- brake pads [92](#)
- warning lamp [92](#)

Breakdown service, refer to Receiving assistance [103](#)

Breaking-in [72](#)

Bulb replacement, refer to Lamps and bulbs [95](#)

Buttons on steering wheel [12](#)

C

California law

- Event Data Recorders [94](#)
- Proposition 65 Warning [6](#)

Calling, refer to telephone Owner's Manual

Can holder, refer to Cup holders [63](#)

Capacities [112](#)

Capacity, cargo area [112](#)

Car care, refer to the Caring for your vehicle brochure

Car-care products, refer to the Caring for your vehicle brochure

Care, refer to the Caring for your vehicle brochure

Cargo, securing [75](#)

Cargo area [67](#)

- capacity [112](#)
- cover [67](#)
- emergency operation, refer to Manual unlocking [19](#)
- floor cover [69](#)
- folding rear seat backrest [67](#)
- lashing eyes [69](#)
- lid, refer to Tailgate [19](#)
- opening, remote control [17](#)
- power socket [69](#)

Cargo loading [74](#)

- determining load limit [74](#)
- securing cargo [75](#)
- stowing cargo [75](#)
- vehicle [74](#)

Caring for artificial leather, refer to the Caring for your vehicle brochure

Caring for leather, refer to the Caring for your vehicle brochure

Caring for plastic, refer to the Caring for your vehicle brochure

Caring for the carpet, refer to the Caring for your vehicle brochure

Caring for the vehicle finish, refer to the Caring for your vehicle brochure

Car keys, refer to Key set [16](#)

Car phone, refer to separate Owner's Manual

Car phone preparation [66](#)

Car radio, refer to Owner's Manual for Radio/Onboard Computer

Car wash [73](#)

- refer to the Caring for your vehicle brochure

Cassette operation, refer to Owner's Manual for Radio/Onboard Computer

Catalytic converter, refer to Hot exhaust system [73](#)

CD operation, refer to Owner's Manual for Radio/Onboard Computer

Central locking system [16](#)

- interior [18](#)

Changes, technical, refer to For your own safety [6](#)

Changing a wheel [99](#)

Changing gears

- automatic transmission with Steptronic [37](#)

Changing wheels [86](#)

Charge-current indicator lamp [12](#), [101](#)

Charging battery [101](#)

Check Gas Cap, warning lamp [12](#), [80](#)

Checking oil level [90](#)

Child's seats, refer to Child-restraint systems [31](#)

Child-restraint fixing system LATCH [33](#)

Child-restraint systems [31](#)

Child-safety locks [33](#)

Chock [99](#)

Chrome parts, care, refer to the Caring for your vehicle brochure

Cigarette lighter [65](#)

Circulation of air, refer to
Recirculated-air mode [57, 60](#)

Cleaning, vehicle, refer to the
Caring for your vehicle brochure

Cleaning rear window [39](#)

Cleaning windows, reservoir [90](#)

Cleaning windshield [39](#)

Clock [43, 44](#)

- 12/24 hour mode [44](#)
- setting, also refer to Owner's Manual for Radio/Onboard Computer
- setting time [43](#)

Closing

- from inside [18](#)
- from outside [16](#)

Clothes hooks [65](#)

Clutch [72](#)

- breaking-in [72](#)

Cockpit [10](#)

Cold start, refer to Starting the engine [34](#)

Combination of wheel/tire [86](#)

Compact wheel, wheel changes [99](#)

Compartments, refer to
Storage compartments [64](#)

Computer [44](#)

- also refer to Owner's Manual for Onboard Computer
- functions [44](#)

Condensation, refer to

- Air conditioner [57, 60](#)
- Parking vehicle [73](#)

Connecting a car vacuum cleaner, refer to Power socket [65](#)

Consumption, refer to
Average fuel consumption [44](#)

Consumption indicator, refer to Fuel gage [42](#)

Controls, refer to Cockpit [10](#)

Convenience operation

- from outside [18](#)
- panorama glass sunroof [18](#)
- windows [18](#)

Coolant [91](#)

- level [91](#)
- temperature gage [42](#)
- warning lamp [91](#)

Cooling, refer to
Temperature [57, 60](#)

Cooling system filling capacity, refer to Filling capacities [112](#)

Copyright [2](#)

Cruise control [40](#)

- buttons on steering wheel [12](#)
- indicator lamp [40](#)

Cruising range [45](#)

Cup holders [63](#)

Curb weight, refer to
Weights [112](#)

Cylinders, refer to Engine data [110](#)

D

Dashboard lighting, refer to
Instrument lighting [54](#)

Dashboard system, refer to
Cockpit [10](#)

Data, technical [110](#)

- dimensions [111](#)
- engine [110](#)
- filling capacities [112](#)
- weights [112](#)

Daytime driving lamps [53](#)

DBC Dynamic Brake Control [47](#)

- warning lamp [49](#)

Deactivating front passenger airbags [31, 52](#)

Decommissioning the vehicle, refer to the Caring for your vehicle brochure

Defective lamp [53](#)

Defects [7](#)

Defrosting windows [58, 60](#)

- air conditioner [58](#)
- automatic climate control [60](#)

Defrosting windows and removing condensation

- air conditioner [58](#)
- automatic climate control [60](#)

Defrosting windshield, refer to
Defrosting windows [58, 60](#)

Defrost position, refer to
Defrosting windows [58, 60](#)

Digital clock [43](#)

Dimensions [111](#)

Dipstick, engine oil [90](#)

Directional indicators, refer to
Turn signals [38](#)

Disc brakes [73](#)

Displacement, refer to Engine data [110](#)

Display illumination, refer to
Instrument lighting [54](#)

Display lighting, refer to
Instrument lighting [54](#)

Displays, refer to Instrument cluster [11](#)

Disposal

- engine oil [91](#)
- vehicle battery [101](#)

Distance warning, refer to
PDC Park Distance Control [46](#)

Door keys [16](#)

Door lock [18](#)

Doors, manual operation [18](#)

DOT Quality Grades [84](#)

Draft-free ventilation [58, 61](#)

Driving lamps, refer to Parking lamps/low beams [53](#)

Driving notes [72](#)

Driving on poor roads [76](#)

Driving stability control systems [47](#)

Driving through water [76](#)

Drying the air, refer to Air conditioner [57, 60](#)

DSC Dynamic Stability Control [47](#)

- indicator lamp [47](#)

- DVD changer, refer to Owner's Manual for Radio/Onboard Computer
- Dynamic Brake Control DBC 47
 - warning lamp 49
- Dynamic Stability Control DSC 47
 - indicator lamp 47

E

- EBV Electronic brake-force distribution 47
- Electrical malfunctions
 - automatic transmission malfunction 38
 - door lock 18
 - driver's door 18
 - fuel filler door 80
 - panorama glass sunroof 22
 - tailgate 19
- Electronic brake-force distribution EBV 47
- Electronic Stability Program ESP, refer to DSC Dynamic Stability Control 47
- Emergency call 103
- Emergency operation, refer to Manual operation
 - doors 18
 - driver's door 18
 - fuel filler door 80
 - panorama glass sunroof 22
 - tailgate 19
- Emergency Service, refer to Receiving assistance 103
- Engine
 - breaking-in 72
 - data 110
 - indicator lamps 34
 - speed 42
- Engine compartment 89
- Engine coolant 91
- Engine oil 90
 - approved engine oils 91
 - indicator/warning lamp 90

- Engine oil grades 91
- Engine oil level 90
 - indicator/warning lamp 90
- Engine oil pressure 90
 - indicator/warning lamp 90
- Engine oil sensor 90
 - indicator/warning lamp 90
- Engine output, refer to Engine data 110
- Equipment range, refer to Service and Warranty Information Booklet for US models, Warranty and Service Guide Booklet for Canadian models
- ESP Electronic Stability Program, refer to DSC Dynamic Stability Control 47
- Exhaust system 73
- Exterior mirrors 28
- Eye, tow-starting and towing 105

F

- Failure of a current consumer 102
- False alarms, refer to Avoiding unintentional alarms 23
- Fastening safety belts, refer to Safety belts 27
- Filter, refer to
 - Microfilter 58
 - Microfilter/activated charcoal filter 61
- Fine wood, refer to the Caring for your vehicle brochure
- First aid, refer to First-aid kit 104
- First-aid kit 104
- Flat tire 99
 - compact wheel 99
 - Flat Tire Monitor 49
 - refer to Tire inflation pressure 82
 - refer to Wheel changes 99

- Flat Tire Monitor 49
 - indicator lamp 50
- Flooding, refer to Driving on poor roads 76
- Floor cover 69
- Fog lamps, indicator lamp 54
- Folding rear seat back 67
- Front airbags 51
- Front fog lamps 54
 - replacing bulbs 97
- Fuel 81
 - average consumption 44
 - capacity 112
 - gage 42
 - quality 81
- Fuel consumption, refer to Average fuel consumption 44
- Fuel display, refer to Fuel gage 42
- Fuel filler door 80
 - releasing in the event of electrical malfunction 80
- Fuel gage 42
- Fuel tank contents, refer to Filling capacities 112
- Fuses 102

G

- Garage-door opener, refer to Integrated universal remote control 62
- Gasoline, refer to Fuel quality 81
- Gasoline display, refer to Fuel gage 42
- Gear change
 - manual transmission 36
- Gear indicator with automatic transmission with Steptronic 37
- Gearshift lever
 - automatic transmission with Steptronic 36
 - manual transmission 36
- General driving notes 72

Glove compartment [64](#)

Grills, refer to

Ventilation [57](#), [61](#)

Gross vehicle weight, refer to

Weights [112](#)

Ground clearance [76](#)

H

Halogen lamps [96](#)

Handbrake [35](#)

– indicator lamp [35](#)

Hands-free microphone, refer to Car phone preparation [66](#)

Hands-free system [66](#)

Hazard warning flashers [10](#)

HDC Hill Descent Control [48](#)

Head airbags [51](#)

Headlamp control, automatic [53](#)

Headlamp flasher [38](#)

– indicator lamp [12](#)

Headlamps [96](#)

– care, refer to the Caring for your vehicle brochure

– replacing bulbs [95](#)

Headlamp washer

reservoir [90](#)

– capacity, refer to Filling capacities [112](#)

Headlamp washer system [90](#)

– headlamp washing [39](#)

– washer fluid [90](#)

Head Light, refer to Adaptive Head Light [53](#)

Head restraints [25](#)

Heated mirrors [29](#)

Heated rear window

– air conditioner [57](#)

– automatic climate control [61](#)

Heated seats [27](#)

Heated steering wheel [28](#)

Heater

– rear window [57](#), [61](#)

– windshield washer jets [39](#)

Heating

– exterior mirror [29](#)

– seats [27](#)

– steering wheel [28](#)

Heating and ventilation [56](#), [59](#)

Heavy cargo, refer to Cargo loading [74](#)

Height, refer to

Dimensions [111](#)

Height adjustment

– seats [25](#), [26](#)

– steering wheel [28](#)

High beams [54](#)

– headlight flasher [54](#)

– indicator lamp [12](#)

– replacing bulbs [96](#)

High Performance Synthetic Oil [91](#)

Hill-climbing ability, refer to Driving on poor roads [76](#)

Hill descent assistance, refer to HDC Hill Descent Control [48](#)

Hill Descent Control HDC [48](#)

Hills [74](#)

Holder for cups [63](#)

Hood [88](#)

Horn [10](#)

Hotel function [16](#)

Hot exhaust system [73](#)

Hydraulic brake assistant, refer to DBC Dynamic Brake Control [47](#)

Hydroplaning [73](#)

I

Ice warning [44](#)

Ignition [34](#)

Ignition key [16](#)

Ignition lock [34](#)

Imprint [2](#)

Index [113](#)

Indicator/warning lamp

– airbags [52](#)

– alarm system [22](#)

– automatic transmission with Steptronic [38](#)

– brakes [92](#)

– coolant temperature [42](#)

– DSC [47](#)

– engine temperature [42](#)

– Flat Tire Monitor [50](#)

– fog lamps [54](#)

– front passenger airbags [52](#)

– reserve [42](#)

– safety belt warning [27](#)

Indicator/warning lamps, overview [11](#)

Individual settings, refer to Vehicle Memory, Key Memory [30](#)

Inflation pressure, refer to Tire inflation pressure [82](#)

Inflation pressure monitoring, refer to Flat Tire Monitor [49](#)

Inside rearview mirror, automatic dimming feature [73](#)

INSPECTION message [43](#)

Instrument cluster [11](#)

Instrument lighting [54](#)

Instrument panel, refer to Cockpit [10](#)

Integrated universal remote control [62](#)

Interior lamps [55](#)

– remote control [17](#)

Interior motion sensor [23](#)

– switching off [17](#), [23](#)

Interior rearview mirror [29](#)

Interlock [34](#)

Intermittent operation,

wipers [38](#)

Interval indicator, Service [43](#)

J

- Jacking points [100](#)
- Jumping, refer to Jump starting [104](#)
- Jump starting [104](#)

K

- Key Memory [30](#)
- Keys [16](#)
- Kick-down [37](#)

L

- Lamps and bulbs [95](#)
- Lashing eyes, refer to Securing cargo [75](#)
- LATCH child-restraint fixing system [33](#)
- LEDs light-emitting diodes [98](#)
- Length, refer to Dimensions [111](#)
- License plate lamp, replacing bulbs [98](#)
- Lifting handle, compact wheel [99](#)
- Light-alloy wheels, care, refer to the Caring for your vehicle brochure
- Light-emitting diodes LEDs [98](#)
- Lighter [65](#)
- Lighter socket [65](#)
- Lighting of instruments [54](#)
- Lights, refer to Parking lamps/low beams [53](#)
- Lights on warning [53](#)
- Light switch [53](#)
- Load, refer to Cargo loading [74](#)
- Lock buttons, doors, refer to Locking [19](#)
- Locking
 - from inside [18](#)
 - from outside [16](#)
- Locking, vehicle
 - from inside [18](#)
 - from outside [16](#)

- Locking and unlocking doors
 - from inside [18](#)
 - from outside [16](#)
- Low beams [53](#)
 - automatic [53](#)
 - indicator lamp, defective lamp [53](#)
 - replacing bulbs [96](#)
- Lower back support, refer to Lumbar support [26](#)
- Lug bolts [100](#)
 - torque [101](#)
- Luggage compartment [19](#)
 - capacity [112](#)
 - cover, refer to Cargo area cover [67](#)
 - floor cover [69](#)
 - increasing volume [67](#)
 - opening/closing, refer to Tailgate [19](#)
 - opening from outside [19](#)
 - opening with remote control [17](#)
 - refer to Cargo area [67](#)
 - remote control [17](#)
- Luggage compartment cover, refer to Cargo area cover [67](#)
- Luggage compartment lid, refer to Tailgate [19](#)
- Luggage compartment net, refer to Partition net [68](#)
- Luggage rack, refer to Roof-mounted luggage rack [76](#)
- Lug wrench [99](#)
- Lumbar support [26](#)

M

- Maintenance [93](#)
- Maintenance system [93](#)
- Malfunctions
 - automatic transmission [38](#)
 - door lock [18](#)
 - fuel filler door [80](#)
 - panorama glass sunroof [22](#)
 - tailgate [19](#)

- Manual operation
 - door lock [18](#)
 - driver's door [18](#)
 - fuel filler door [80](#)
 - panorama glass sunroof [22](#)
 - tailgate [19](#)
- Manual transmission [36](#)
- Master key [16](#)
 - with remote control [16](#)
- Maximum speed, with winter tires [86](#)
- Mechanical seats [25](#)
- Memory, refer to
 - Seat and mirror memory [26](#)
 - Vehicle Memory, Key Memory [30](#)
- Microfilter
 - air conditioner [58](#)
 - automatic climate control [61](#)
- Microphone, refer to Car phone preparation [66](#)
- Microphone for telephone [66](#)
- Mini-Disc operation, refer to Owner's Manual for Radio/Onboard Computer
- Mirrors [28](#)
 - automatic curb monitor [29](#)
 - mirror heating [29](#)
 - mirror memory, refer to Seat and mirror memory [26](#)
- Multi-function steering wheel, refer to Buttons on steering wheel [12](#)
- Multifunction switch
 - turn signals/headlamp flasher [38](#)
 - washer/wiper system [38](#)

N

- Navigation system, refer to Owner's Manual for Onboard Computer/Radio and Navigation System
- Neck support, refer to Head restraints [25](#)
- Nets [65](#)
- Non-smoker's equipment package [65](#)

Nozzles, refer to
Ventilation [57](#), [61](#)
Nylon rope, refer to Tow-
starting and towing [105](#)

O

OBD connector [93](#)
Octane rating, refer to Fuel
quality [81](#)
Odometer [42](#)
Oil
– approved engine oils [91](#)
– capacity [112](#)
– dipstick [90](#)
Oil change interval
– refer to Service and
Warranty Information
Booklet for US models,
Warranty and Service Guide
Booklet for Canadian
models
– refer to Service Interval
Display [43](#)
Oil consumption [90](#)
Oil grades [91](#)
Oil level [90](#)
– warning lamp [90](#)
Oil pressure [90](#)
– warning lamp [90](#)
Oil sensor [90](#)
– warning lamp [90](#)
OIL SERVICE [43](#)
Old batteries, refer to
Disposal [101](#)
Onboard computer, refer to
separate Owner's Manual
Onboard Diagnostics OBD
interface socket [93](#)
Onboard tool kit [95](#)
Opening and closing
– from inside [18](#)
– from outside [16](#)
– using the door lock [18](#)
– using the remote control [16](#)
Output, refer to Engine
data [110](#)

Outside air
– air conditioner [57](#)
– automatic climate control [60](#)
Outside temperature display
– changing unit of measure [44](#)
– in computer [44](#)

P

Panorama glass sunroof [21](#)
– automatic opening and
closing [21](#)
– closing with electrical
malfunction [22](#)
– comfort operation [18](#)
– comfort position [21](#)
– initializing [21](#)
– power failure [21](#)
– remote control [17](#)
Parcel shelf, refer to Cargo
area cover [67](#)
Park Distance Control PDC [46](#)
Parking aid, refer to PDC Park
Distance Control [46](#)
Parking brake, refer to
Handbrake [35](#)
Parking lamps [53](#)
– replacing bulbs [97](#)
Parking lamps/low beams [53](#)
Parking vehicle [35](#)
Partition net [68](#)
Parts and accessories, refer to
For your own safety [6](#)
Passenger-side mirror tilt
function [29](#)
Pathway lighting [53](#)
PDC Park Distance Control [46](#)
Plastic, refer to the Caring for
your vehicle brochure
Pollen, refer to
– Microfilter [58](#)
– Microfilter/activated
charcoal filter [61](#)
Portable phone, refer also to
separate Owner's Manual
Power failure
– battery [102](#)
– panorama glass sunroof [21](#)
– windows [20](#)

Power seat adjustment [26](#)
Power socket [65](#), [69](#)
Power windows [20](#)
– initializing [20](#)
– safety switch [20](#)
Pressure, tires [82](#)
Pressure monitoring, tires [49](#)
– Flat Tire Monitor [49](#)
Programming settings, refer
to Vehicle Memory, Key
Memory [30](#)
Protective function, panorama
glass sunroof [21](#)
Puncture, Flat Tire Monitor [49](#)

R

Radiator, refer to Coolant [91](#)
Radio, refer to Owner's
Manual for Radio/Onboard
Computer
Radio-control key, refer to
Master key with remote
control [16](#)
Radio navigation, refer to
separate Owner's Manual
Rain sensor [39](#)
Range, setting units [44](#)
Reading lamps
– front [55](#)
– rear [55](#)
Rear backrests, folding [67](#)
Rear seat back, folding [67](#)
Rearview mirrors, exterior [28](#)
Rear window defroster
– air conditioner [57](#)
– automatic climate control [61](#)
Rear window safety switch [20](#)
Rear window wiper [39](#)
– wiper blade replacement [95](#)
Recirculated-air mode
– air conditioner [57](#)
– automatic climate control [60](#)
Reflector, refer to Tail
lamps [98](#)
Refueling [80](#)
– fuel filler door [80](#)
Remaining distance, refer to
Cruising range [45](#)

Remaining distance for Service 43

Remote control 16

- garage-door opener 62
- malfunction 17
- tailgate 17

Removing condensation, windows

- air conditioner 58
- automatic climate control 60

Replacement fuses 102

Replacement keys 16

Replacing bulbs, refer to Lamps and bulbs 95

Replacing tires

- new wheels and tires 86
- wheel changes 99

Replacing windshield wiper 95

Reporting safety defects 7

Reserve indicator lamp, refer to Fuel gage 42

Restraint systems

- for children 31
- refer to Safety belts 27

Reverse gear

- automatic transmission with Steptronic 37
- manual transmission 36

Roadside Assistance, refer to Receiving assistance 103

Roadside parking lamps 54

- replacing bulbs 97

Roll-up cover, refer to Cargo area cover 67

Roof load, refer to Weights 112

Roof-mounted luggage rack 76

Rope, refer to Tow-starting and towing 105

Rotating coin holder, refer to Storage compartments 64

Run-flat indicator, refer to Flat Tire Monitor 49

S

Safety belts 27

- sitting safely 24
- warning lamp 27

Safety belt tensioners, refer to Safety belts 27

Safety defects, reporting 7

Safety feature, power windows 20

Safety systems, refer to

- ABS Antilock Brake System 47
- Airbags 51
- DSC Dynamic Stability Control 47
- xDrive 48

Screwdriver, refer to Onboard tool kit 95

Seat heating 27

Seat memory, refer to Seat and mirror memory 26

Seats

- adjusting electrically 26
- adjusting sports seat 25
- heating 27
- memory, refer to Seat and mirror memory 26
- sitting safely 24
- storing the setting 26

Securing cargo, refer to Cargo loading 74

Selector lever, automatic transmission 37

Selector lever interlock, refer to Shiftlock 37

Selector-lever positions, automatic transmission 36

Service, refer to Receiving assistance 103

Service and warranty 7

Service Engine Soon 34, 94

Service Interval Display 43, 93

Setting interior temperature 57, 60

Shifting gears, with automatic transmission with Steptronic 37

Shiftlock 37

Side airbags 51

Side tilt, permissible 76

Side turn signals, replacing the bulbs 97

Sitting safely 24

- with airbags 24
- with safety belts 24

Ski bag 66

Smokers' package, refer to Ashtray 65

Snow chains 87

SOS, refer to Initiating an emergency call 103

Spare fuses 102

Spare key 16

Spare tire, refer to Wheel changes 99

Spare wheel, refer to Compact wheel 99

Specified oils 91

Speed

- with compact wheel 101
- with winter tires 86

Speedometer 11

- refer to Instrument cluster 11

Sport program, automatic transmission with Steptronic 37

Sports seat 25

Stability control, refer to DSC Dynamic Stability Control 47

Starting, refer to Engine 34

Starting difficulties

- jump starting 104

Starting engine 34, 35

Starting problems at very low temperatures 35

Status of this Owner's Manual at time of printing 5

Steering lock 34

Steering wheel 10, 12

- adjustment 28
- buttons 12
- lock 34

Steering wheel heater 28

Steering wheel with buttons **12**
Steptronic **36**
Storage compartments **64, 65**
Storage package **65**
Storage package nets **65**
Storage space, refer to Cargo area **67**
Storing desired speed, refer to Cruise control **40**
Storing seat position, refer to Seat and mirror memory **26**
Storing tires **86**
Straps, refer to Cargo loading **74**
Supply reservoirs, washer systems **90**
Switches, refer to Cockpit **10**
Switching off engine **35**
Symbols **4**

T

Table of contents **3**
Tachometer **42**
Tailgate **19**
– closing **19**
– emergency operation **19**
– emergency operation, refer to Manual unlocking **19**
– opening, remote control **17**
– opening from outside **19**
– remote control **17**
– unlocking manually **19**
Tailgate lamp, replacing bulbs **98**
Tail lamps **98**
– indicator lamp, defective lamp **53**
– replacing bulbs **98**
Tank capacity **112**
Technical data **110**
Technical modifications **6**
Telephone, refer to separate Owner's Manual
Temperature
– air conditioner **57**
– automatic climate control **60**
Temperature, tires **85**
Temperature display
– ice warning **44**
– outside temperature **44**
– setting units **44**
Temperature gage **42**
Tempomat, refer to Cruise control **40**
The right wheels and tires **86**
Thigh support adjustment **25, 26**
Three-point safety belt **27**
Tightening torque of the lug bolts, refer to After mounting **101**
Tilt alarm sensor
– remote control **17**
– switching off **17**
Tilt function, passenger-side mirror **29**
Tire inflation pressures **82**
Tires
– age **84**
– breaking-in **72**
– changing **86**
– changing, refer to Wheel changes **99**
– condition **85**
– damage **85**
– DOT Quality Grades **84**
– flat **99**
– inflation pressure **82**
– inflation pressure table **83**
– size, refer to The right wheels and tires **86**
– storage **86**
– temperature **85**
– traction **84**
– tread **85**
– tread wear **84**
– tread wear indicator, refer to Tire tread **85**
– Uniform Tire Quality Grading **84**
– winter tires **86**
Tools, refer to Onboard tool kit **95**
Torque
– engine **110**
– lug bolts **101**
Tow bar **105**
Tow fitting **105**
Towing **105**
– with automatic transmission **105**
Towing eye **105**
Towing the vehicle **105**
Tow rope **106**
Tow sockets for tow fitting **105**
Tow-starting **105**
Track width, refer to Dimensions **111**
Traction **84**
Traction aid, refer to DSC **47**
Traction control, refer to DSC Dynamic Stability Control **47**
Transmission
– automatic transmission with Steptronic **36**
– manual transmission **36**
Transmission locking mechanism, refer to P Parking **37**
Transmission malfunction, refer to Malfunction **38**
Transporting children safely **31**
Transport securing device, refer to Securing cargo **75**
Tread depth, refer to Tire tread **85**
Tread wear **84**
Tread wear indicator in tire, refer to Tire tread **85**
Trip-distance counter, refer to Trip odometer **42**
Trip odometer **42**
Trunk **19**
– capacity **112**
– opening from outside **19**
– refer to Cargo area **67**
Trunk lid, refer to Tailgate **19**
Turning circle, refer to Dimensions **111**

- Turn signals [38](#)
- indicator lamp [12](#)
- replacing bulbs [97](#)
- Turn signals, side, replacing bulbs [97](#)

U

- Undercarriage protection, refer to the Caring for your vehicle brochure
- Units [44](#)
- outside temperature [44](#)
- Universal garage-door opener, refer to Integrated universal remote control [62](#)
- Universal portable phone preparation, refer to separate Owner's Manual
- Universal remote control [62](#)
- Unlocking
- from inside [18](#)
- from outside [16](#)
- hood [88](#)
- Upholstery care, refer to the Caring for your vehicle brochure

V

- Valve
- insert [101](#)
- screw cap [101](#)
- Vehicle
- battery [101](#)
- breaking-in [72](#)
- care, refer to the Caring for your vehicle brochure
- cargo loading [74](#)
- decommissioning, refer to the Caring for your vehicle brochure
- dimensions [111](#)
- parking [35](#)
- washing, refer to the Caring for your vehicle brochure
- weights [112](#)
- Vehicle battery [101](#)

- Vehicle jack [99](#)
- jacking points [100](#)
- Vehicle jacking points [100](#)
- Vehicle Memory [30](#)
- Ventilation [57](#), [61](#)
- draft-free [58](#), [61](#)
- Viscosity [91](#)
- Voice control, refer to separate Owner's Manual

W

- Warning and indicator lamps [11](#)
- Warning triangle [103](#)
- Warranty, refer to Service and Warranty Information Booklet for US models, Warranty and Service Guide Booklet for Canadian models [93](#)
- Warranty and service [7](#)
- Washer fluid [90](#)
- Washer fluid reservoir
- capacity, refer to Filling capacities [112](#)
- refer to Windshield/headlamp washer system [90](#)
- Weights [112](#)
- Wheel/tire combination [86](#)
- Wheelbase, refer to Dimensions [111](#)
- Wheel bolt, wrench [99](#)
- Wheel changes, compact wheel [99](#)
- Wheels and tires [86](#)
- Width, refer to Dimensions [111](#)
- Windows [20](#)
- convenience operation [18](#)
- safety switch [20](#)
- Windshield washer reservoir [90](#)
- capacity, refer to Filling capacities [112](#)
- Windshield washer system
- washer/wiper system [38](#)
- washer fluid [90](#)

- Windshield wiper blade replacement [95](#)
- Windshield wipers, refer to Washer/wiper system [38](#)
- Winter tires [86](#)
- changing [99](#)
- condition [85](#)
- storage [86](#)
- Wiper blade replacement [95](#)
- Wiper system [38](#), [90](#)
- Wood decor, refer to Fine wood parts
- Working in the engine compartment [88](#)
- Wrenches, refer to Onboard tool kit [95](#)

X

- xDrive [48](#)
- Xenon lamps [97](#)
- replacing bulbs [97](#)

Refueling

To ensure that you always have all the essential data at hand when refueling, we recommend that you fill in the following tables with the specifications and information that apply to your vehicle. Consult the index for individual specifications.

Fuel

Designation

Please enter your preferred fuel here.

Engine oil

Quality

The oil quantity between the two marks on the dipstick is approx. 1.1 US quarts/1 liter.

Tire inflation pressures

	Summer tires Front	Rear	Winter tires Front	Rear
Up to 4 persons				
5 persons or 4 plus luggage				

More about BMW

bmwusa.com



The Ultimate
Driving Machine

01 41 0 158 448 ue



