

Owner's Manual
for Vehicle



The Ultimate
Driving Machine



Z4 2.5i Z4 3.0i

Congratulations, and thank you for choosing a BMW.

Thorough familiarity with your vehicle will provide you with enhanced control and security when you drive it. Therefore, we have one request:

Please take the time to read this Owner's Manual and familiarize yourself with the information that we have compiled for you before starting off in your new BMW. The manual contains important data and instructions intended to assist you in obtaining maximum satisfaction from your BMW's unique array of advanced technical features. It also contains information on vehicle maintenance designed to enhance operating safety while simultaneously helping you to maintain your BMW's value throughout an extended service life. For additional information refer to the supplemental manuals.

This Owner's Manual should be considered a permanent part of this vehicle. It should stay with the vehicle when sold to provide the next owner with important operating, safety and maintenance information.

We wish you an enjoyable driving experience.

BMW AG

© 2004 Bayerische Motoren Werke
Aktiengesellschaft
Munich, Germany
Reprinting, including excerpts, only with the
written consent of BMW AG, Munich.
Order No. 01 41 0 158 704
US English IX/04
Printed in Germany
Printed on environmentally friendly paper,
bleached without chlorine, suitable for recycling.

Contents

The fastest way to find information on special topics is by using the index starting on page [106](#).

Using this Owner's Manual

[4](#) Notes

At a glance

[10](#) Cockpit

Controls

[16](#) Opening and closing

[27](#) Adjustments

[33](#) Transporting children safely

[36](#) Driving

[46](#) Everything under control

[50](#) Technology for safety and driving convenience

[56](#) Lamps

[58](#) Controlling the climate for pleasant driving

[64](#) Interior conveniences

Driving tips

[68](#) Special operating instructions

Mobility

[76](#) Refueling

[78](#) Wheels and tires

[84](#) In the engine compartment

[89](#) Maintenance

[91](#) Replacement procedures

[96](#) Giving and receiving assistance

Reference

[102](#) Technical data

[106](#) Everything from A to Z

Notes

About this Owner's Manual

We have made every effort to ensure that you are able to find what you need in this Owner's Manual as quickly as possible. The fastest way to find certain topics is by using the detailed index at the end. If you wish to gain an initial overview of your vehicle, you will find what you are looking for in the first chapter.

Should you sell your BMW at some time in the future, please remember to pass the Owner's Manual on to the new owner. The manual represents an important component of the vehicle.

Additional sources of information

If you have additional questions, your BMW center will be glad to advise you.

You can find more information about BMW, for example on its technology, on the Internet under www.bmw.com.

Symbols used



Indicates precautions that must be followed precisely in order to avoid the possibility of personal injury and serious damage to the vehicle.



Indicates information that will assist you in gaining the optimum benefit from your vehicle and enable you to care more effectively for your vehicle.



Refers to measures that can be taken to help protect the environment.

◀ Marks the end of a specific item of information.

* Indicates special equipment, country-specific equipment and optional extras, as well as equipment and functions not yet available at the time of printing.



Vehicle Memory, Key Memory, refer to page 31. Identifies functions that can be specifically adapted for a particular key or vehicle. These adjustments can be performed by your BMW center.

Symbol on vehicle parts



Indicates that you should consult the relevant section of this Owner's Manual for information on a particular part or assembly.

Your individual vehicle

On buying your BMW, you have decided in favor of a model with individualized equipment and features. This Owner's Manual describes all models and equipment that BMW offers within the same group.

We hope you will understand that equipment and features are included which you might not have chosen for your vehicle. Any differences can easily be identified since all optional accessories and special equipment are marked with an asterisk *.

If your BMW features equipment not described in this Owner's Manual, please observe the enclosed supplementary Owner's Manuals.

Status at time of printing

BMW pursues a policy of continuous, ongoing development that is conceived to ensure that our vehicles continue to embody the highest quality and safety standards combined with advanced, state-of-the-art technology. In exceptional cases, the features described in this Owner's Manual could therefore differ from those on your vehicle.

For your own safety

Maintenance and repair

 Advanced technology, e.g. the use of modern materials and high-performance electronics, requires specially adapted maintenance and repair methods. Therefore, only have corresponding work on your BMW carried out by a BMW center or a workshop that works according to BMW repair procedures with correspondingly trained personnel. If work is carried out improperly there is a danger of consequential damage and the related safety risks. ◀

California Proposition 65 warning

California laws require us to state the following warning:

 Engine exhaust and a wide variety of automobile components and parts, including components found in the interior furnishings in a vehicle, contain or emit chemicals known to the State of California to cause cancer and birth defects and reproductive harm. In addition, certain fluids contained in vehicles and certain products of component wear contain or emit chemicals known to the State of CA to cause cancer and birth defects or other reproductive harm.

Battery posts, terminals and related accessories contain lead and lead compounds. Batteries also contain other chemicals known to the State of California to cause cancer. Wash your hands after handling.

Used engine oil contains chemicals that have caused cancer in laboratory animals. Always protect your skin by washing thoroughly with soap and water. ◀

Parts and accessories

 For your own safety, use parts and accessories approved by BMW.

When you purchase accessories tested and approved by BMW and Original BMW Parts, you simultaneously acquire the assurance that they have been thoroughly tested by BMW to ensure optimum performance when installed on your vehicle.

BMW warrants these parts to be free from defects in material and workmanship. BMW will not accept any liability for damage resulting from installation of parts and accessories not approved by BMW.

BMW cannot test every product made by other manufacturers to verify if it can be used on a BMW safely and without risk to either the vehicle, its operation, or its occupants.

Original BMW Parts, BMW Accessories and other products approved by BMW, together with professional advice on using these items, are available from all BMW retailers.

Installation and operation of non-BMW approved accessories such as alarms, radios, amplifiers, radar detectors, wheels, suspension components, brake dust shields, telephones, including operation of any portable cellular phone from within the vehicle without using an externally mounted antenna, or transceiver equipment, e.g. C.B., walkie-talkie, ham radio or similar, may cause extensive damage to the vehicle, compromise its safety, interfere with the vehicle's electrical system or affect the validity of the BMW Limited Warranty. See your BMW center for additional information.

Do not use key or remote control to lock doors or trunk with anyone inside the vehicle. Refer to the Owner's Manual for more details. ◀

 Maintenance, replacement or repair of the emission control devices and systems may be performed by any automotive repair establishment or individual using any certified automotive part. ◀

Service and warranty

This manual is supplemented by a Service and Warranty Information Booklet for US models, Warranty and Service Guide Booklet for Canadian models.

We recommend that you read this publication thoroughly.

Your BMW is covered by the following warranties:

- ▷ New Vehicle Limited Warranty
- ▷ Rust Perforation Limited Warranty
- ▷ Federal Emissions System Defect Warranty
- ▷ Federal Emissions Performance Warranty
- ▷ California Emission Control System Limited Warranty.

Detailed information about these warranties is listed in the Service and Warranty Information Booklet for US models, Warranty and Service Guide Booklet for Canadian models.

Reporting safety defects

The following only applies to vehicles owned and operated in the US.

If you believe that your vehicle has a defect which could cause a crash or could cause injury or death, you should immediately inform the National Highway Traffic Safety Administration NHTSA in addition to notifying BMW of North America, LLC, P.O. Box 1227, Westwood, New Jersey 07675-1227, telephone toll-free 1-800-831-1117.

If NHTSA receives similar complaints, it may open an investigation, and if it finds that a safety defect exists in a group of vehicles, it may order a recall and remedy campaign. However, NHTSA cannot become involved in individual problems between you, your retailer, or BMW of North America, LLC.

To contact NHTSA, you may either call the Auto Safety Hotline toll-free at 1-800-424-9393 or 366-0123 in Washington, D.C. area, or write to: NHTSA, U.S. Department of Transportation, Washington, D.C. 20590. You can also obtain other information about motor vehicle safety from the Hotline.





At a glance

The overviews of buttons, switches and displays presented in this chapter will help you find your way around your vehicle. You will also be familiarized with the concepts behind the operation of the features available to you.

Cockpit

Control elements

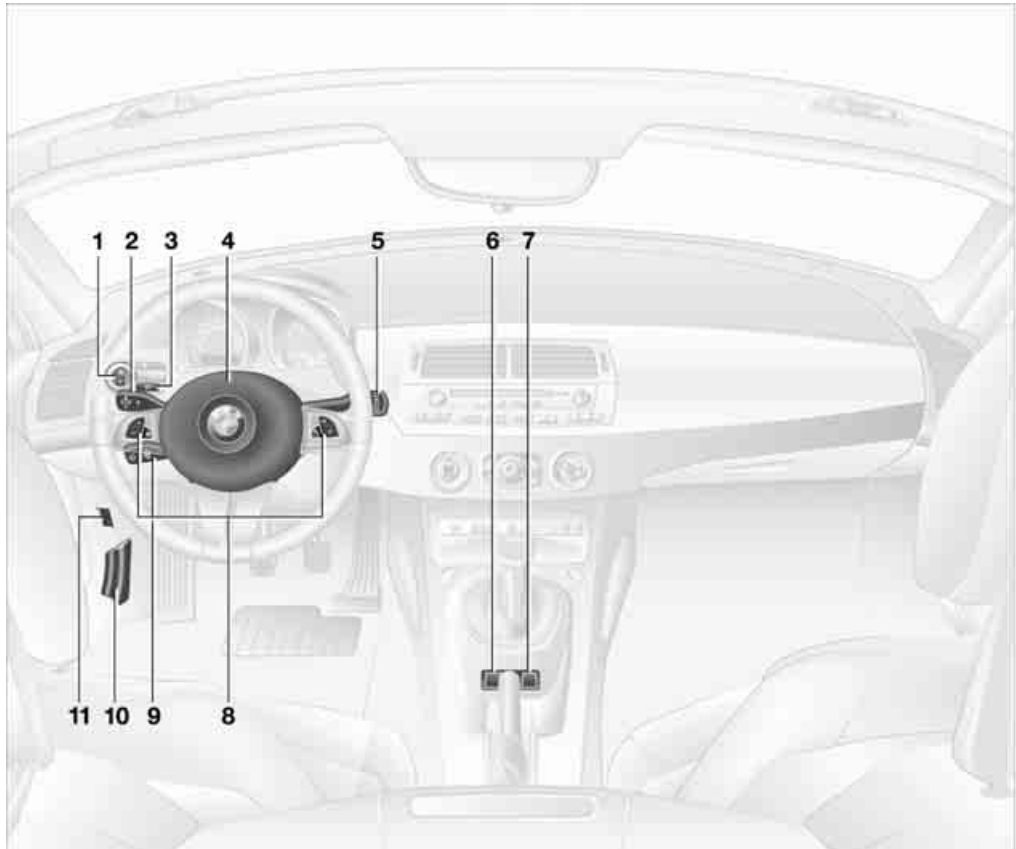

1 Parking lamps/Low beams [56](#)

2 ▷ Turn signal indicators [42](#)

▷ Standing lamps [57](#)

▷ High beams [57](#)

▷ Headlamp flasher [42](#)

▷ Computer* [48](#)

3 Fog lamps* [57](#)

4 Horn

5 Washer/wiper system/Rain sensor* [43](#)

6 Hazard warning flashers

7 Central locking system [16](#)

8 Buttons in steering wheel*



Volume



Press briefly:

Accept incoming call, start dialing, terminate call

Extended pressure:

Activate and deactivate voice entry

R/T

Display/hide telephone book. Display the entries one after another with the forward/backward buttons



Fast forward/rewind

- ▷ Radio
 - Press briefly: next station stored
 - Extended pressure: station search
 - ▷ CD
 - Press briefly: jump to next track
 - Extended pressure: fast forward/rewind
 - ▷ Telephone
 - Scan register of names
- 9** Cruise control* 44
- 10** Hood release 84
- 11** Luggage compartment lid release 18

Instrument cluster

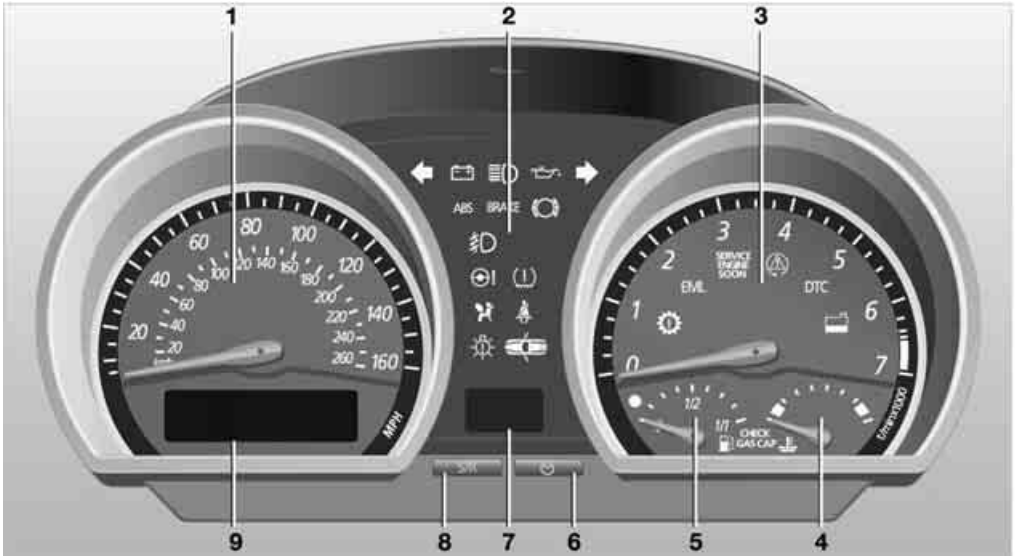

- 1 Speedometer
- 2 Indicator and warning lamps 12
- 3 Tachometer 46
with indicator and warning lamps 12
- 4 Engine coolant temperature gauge 46
- 5 Fuel gauge 46
- 6 Button for
 - ▷ Time 47
 - ▷ Service interval display 47
- 7 Display field for selector lever and program indicator
 - ▷ Automatic transmission* 38
 - ▷ Sequential manual gearbox SMG* 40
- 8 Button for
 - ▷ Trip odometer, reset to zero 46
 - ▷ Setting time 47
- 9 Display for
 - ▷ Trip odometer/Odometer 46
 - ▷ Clock 47
 - ▷ Service interval 47
 - ▷ Computer* 48

Indicator and warning lamps

Technology that monitors itself

Indicator and warning lamps that are identified by ● are tested for proper functioning whenever the ignition key is turned. They each light up once for different periods of time.

If a malfunction occurs in one of the monitored systems, the corresponding light does not go out after the engine has started, or it lights up again while the vehicle is in motion. You can find more information about each system on the specified pages.



Safety belt reminder ● 30



Airbags ● 53



Battery charge current ● 94



Engine oil pressure/Engine oil level/
Engine oil sensor ● 86



Brake system ●
Parking brake released 88
Parking brake applied 37
With other warning lamps 51



Brake warning lamp for Canadian
models



Antilock Brake System ABS/Driving
stability control systems ● 50



Antilock Brake System ABS/Driving
stability control systems for Canadian
models



Dynamic Stability Control
DSC ● 50



Dynamic Traction Control
DTC ● 50



Flat Tire Monitor ● 52



Automatic transmission/Sequential
manual gearbox SMG ● 39, 41



Brake pads ● 88



Add coolant 87



Check gas cap ● 76



Service engine soon ● 90



Service engine soon indicator lamp for
Canadian models



Defective bulb 56



Turn signal indicators 42



Fog lamps 57



Headlamp flasher/High beams 42, 57



Electric Power Steering ● 42



Doors or luggage compartment lid
open



Engine electronics ●
Malfunction in the engine electronics.
You can continue to drive with
reduced engine output or engine
speed. Please have the system
inspected by your BMW center.

Colors

The indicator and warning lamps can light up in various colors and combinations.

- ▷ Red:
Stop the vehicle immediately
or
an important reminder
- ▷ Red and yellow:
Continue driving cautiously
- ▷ Yellow:
Have the system checked soon
or
for your information
- ▷ Green or blue:
For your information.





Controls

This chapter provides you with the information you need for complete control over your vehicle. It describes all features used for driving and for ensuring your safety and comfort.

Opening and closing

The key set

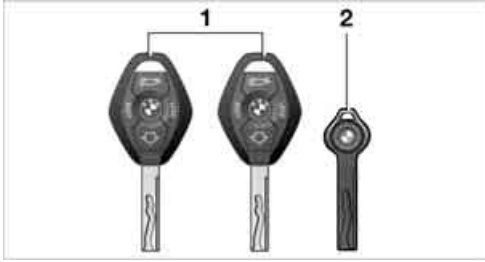

1 Master keys with remote control

Each key is powered by an extended-life battery that is charged automatically in the ignition lock as you drive. For this reason, use every master key at least twice a year to keep its battery charged. Depending on which master key is recognized when the vehicle is unlocked, different settings are called up and carried out in the vehicle, refer to Key Memory on page 31.

2 Spare key

For storage in a safe place, e.g. in your wallet.
This key is not intended for constant use.

New keys

You can obtain new keys, whether as additional keys or replacement keys, at your BMW center.

Central locking system

The concept

The central locking system is ready for operation whenever the driver's door is closed. The system simultaneously engages and releases the locks on the

- ▷ doors
- ▷ luggage compartment lid
- ▷ fuel filler door

- ▷ storage compartment between the backrests

- ▷ opened manual convertible top.

The central locking system can be operated

- ▷ from outside using the remote control or via the driver's door lock
- ▷ from inside via the central locking system button.

If it is operated from inside, the fuel filler door will not be locked. Refer to page 18.

The anti-theft system is automatically activated whenever you activate the central locking system from outside the vehicle. It prevents the doors from being unlocked with the lock buttons or release handles. The alarm system is also armed.

In the event of a sufficiently severe accident, the central locking system unlocks automatically. In addition, the hazard warning flashers and interior lamps come on.

Opening and closing: from outside

With the remote control

Whenever you unlock or lock the vehicle, you simultaneously deactivate/activate the anti-theft system, disarm/arm the alarm system and switch the interior lamps on/off.

You will find more information about the alarm system on page 25.



Since persons or animals in the vehicle could lock the doors from the inside, always take the vehicle keys with you so that the vehicle can be opened again from the outside at any time. ◀

To unlock

Press the  button.

Press the button once to unlock the driver's door and the fuel filler door; press a second time to disengage all vehicle locks.

Convenience opening mode

Keep the  button pressed:

The windows and the fully automatic convertible top are opened.

To lock and secure

Press the  LOCK button.

The hazard warning flashers light up once.



If you wish, you can have this special feature activated/deactivated. ◀

To switch on the interior lamps

With the vehicle locked:

Press the  LOCK button.

With this function, you can also search for your vehicle when parked in an underground garage, for instance.

To open the luggage compartment

Press button  briefly.

The luggage compartment lid will open slightly, regardless of whether it was locked or unlocked.



Before and after a trip, be sure that the luggage compartment lid has not been opened unintentionally. ◀

Panic mode*

By pressing and holding button  for more than approx. two seconds, you can trigger the alarm systems* in response to any impending danger.

To switch off the alarm: press any of the buttons.

Malfunction

Local radio waves can impede the functioning of the remote control.

Should this occur, open and close the vehicle using the master key in either a door or the luggage compartment lock.

If it is no longer possible to lock the vehicle with the remote control, the battery is discharged. Use this remote control key while driving for an extended period in order to recharge the battery, refer to page 16.

For US owners only

The transmitter and receiver units comply with part 15 of the FCC, Federal Communications Commission, regulations. Operation is governed by the following:

FCC ID: LX8EWS

LX8FZVS

LX8FZVE

Compliance statement:

This device complies with part 15 of the FCC Rules. Operation is subject to the following two conditions:

- ▷ This device may not cause harmful interference, and
- ▷ this device must accept any interference received, including interference that may cause undesired operation.



Any unauthorized modifications to these devices could void the user's authority to operate the equipment. ◀

At the door lock

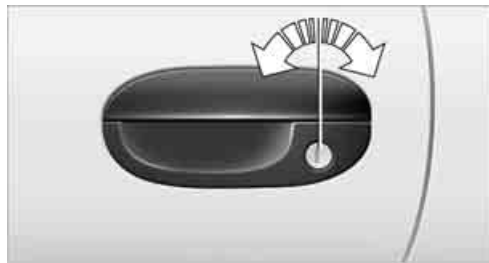

One turn of the key in the driver's door lock unlocks the driver's door and the fuel filler door.

Turn the key a second time to disengage all other vehicle locks.

When the vehicle is locked, the hazard warning flashers light up once.



If you wish, you can have this special feature activated/deactivated. ◀

Convenience operation

You can also operate the windows and the fully automatic convertible top via the door lock.

- ▷ To open:
With the door closed, hold the key in the Unlock position
- ▷ To close:
With the door closed, hold the key in the Lock position.

⚠ Watch the closing process to ensure that no one is trapped. Releasing the key stops the operation. ◀

Manual operation

If there is an electrical malfunction, you can unlock or lock the driver's door by turning the key in the lock all the way to the left or right.

Opening and closing: from inside



You can use this button to control the central locking system whenever the doors are closed. The doors and luggage compartment lid are unlocked or locked only. The anti-theft system is not activated.

If only the driver's door was unlocked from the outside and you press the button, then, with the driver's door still open, the luggage compartment lid and the fuel filler door will unlock, too. If the driver's door is closed, it will be locked.

👤 If you desire, the central locking system can be activated automatically as soon as you begin to drive. This can be adjusted to be key-specific. ◀

To unlock and open

- ▷ Either unlock the doors together with the button for the central locking system and then pull each of the release handles above the armrests
or
- ▷ pull the release handle for each door twice: the initial pull unlocks the door, and the second one opens it.

To lock

- ▷ Either use the central locking button to lock both doors at once or
- ▷ press the individual door lock buttons down.

▷ To prevent the driver from being inadvertently locked out of the vehicle, the driver's door lock button will not engage as long as the door is open. ◀

⚠ Since persons or animals in the vehicle could lock the doors from the inside, always take the vehicle keys with you so that the vehicle can be opened again from the outside at any time. ◀

Luggage compartment lid

To open from the outside

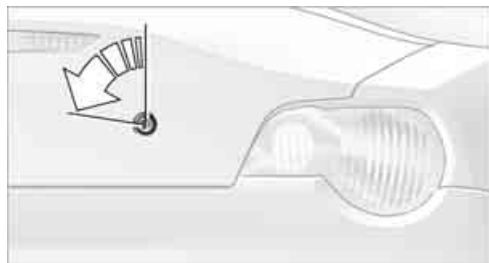

Turn the master key to the left as far as it will go. The luggage compartment lid will open slightly.

If the alarm system is armed, opening the luggage compartment with the key will trigger an alarm; refer also to page 25.

To open from inside the vehicle



If the luggage compartment lid has not been locked separately, you can open it with this button in the footwell on the driver's side when the vehicle is stationary.

To close



The handle recess in the interior trim panel of the luggage compartment lid makes it easier to pull the lid down.

⚠ To avoid injuries, be sure that the travel path of the luggage compartment lid is clear when it is closed, following the same precautions as with all closing procedures. ◀

Luggage compartment

Emergency release



This lever releases the luggage compartment lid from inside the luggage compartment.

To enlarge the luggage compartment

The luggage compartment can be enlarged when the convertible top is closed.

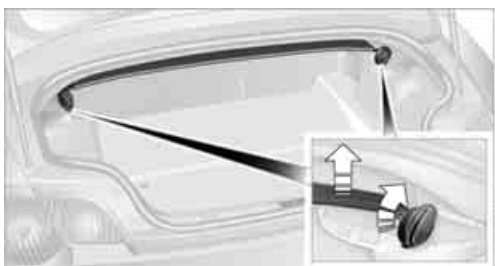

Simultaneously turn the handles on both sides of the luggage compartment outward past the resistance point.

The convertible top compartment panel is raised.

Before opening the convertible top:

Turn both handles inward.

The convertible top compartment panel is lowered.

⚠ Before opening the convertible top, make sure that the convertible top compartment panel has been folded down in the luggage compartment to avoid any possible damage. ◀

Windows

To open and close a window

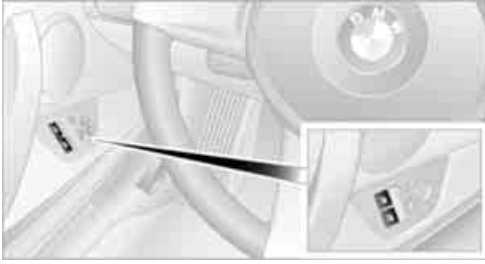

Ignition key in position 1 or higher:

- ▷ Press the switch downward until you feel resistance: the window continues to move downward as long as you continue to press the switch
- ▷ Tap the switch past the pressure point: the window moves downward automatically. Tapping the switch again stops the opening cycle.

You can close the window in the same manner by pulling the switch upward.



If you wish, you can have this special feature activated/deactivated. ◀

After the ignition has been switched off

You can still open or close the windows for up to 15 minutes, as long as no one opens any of the doors.

 When leaving the vehicle, always remove the ignition key from the lock and remember to close the doors, since children could otherwise operate the windows and injure themselves, etc. ◀

For convenience operation via the remote control or the door lock, refer to page 17 or 18, respectively.

Pressure-sensitive finger guard system

If the closing force exceeds a certain value while a window is being raised, the system will respond by stopping the window and then retracting it a small distance.



Despite the finger guard system, make sure that the windows can close without obstruction, since in some cases, e.g. with thin objects, it is not guaranteed that the closing operation will be interrupted.

The finger guard system function is restricted when the switch is pulled and held beyond the pressure point. ◀

After a power supply interruption

After a power supply interruption, for instance after disconnecting the battery, the pressure-sensitive finger guard system must be reinitialized:

Ensure that the doors and convertible top are closed before initializing. Perform the following procedure twice for each window:

- ▷ Open and close the window completely
- ▷ With the window closed, keep pulling the switch upward for approx. 1 second.

Manual convertible top

The fabric top offers perfect protection against the weather and it can be opened easily and quickly by one person alone.

Here are a few tips so that you get the most out of your BMW:

- ▷ It is advisable to close the convertible top when the vehicle is parked. The closed convertible top not only protects the passenger compartment from unforeseeable damage from the weather, but also provides a certain degree of theft protection
- ▷ In addition, only keep valuables in the locked luggage compartment, even with the convertible top closed
- ▷ When the convertible top is open, the central locking system also locks the release button for the convertible top. The convertible top cannot be operated. This provides better theft protection for valuables stored in the luggage compartment
- ▷ Never mount a roof-mounted luggage rack system on the convertible top.

 Never store the convertible top for longer than one day while it is wet to avoid permanent damage from moisture. ◀

To open

 Operate the convertible top only when the vehicle is stationary. Before opening the convertible top, make sure that the convertible top compartment panel has been folded down in the luggage compartment to avoid any possible damage, refer to page 19. ◀

1. Flip the handle out and turn it to the end stop



2. Fold the handle back in

 Do not guide the convertible top towards the rear with the handle folded out, as the convertible top's headliner could otherwise be damaged. ◀

3. Open the convertible top and push it toward the rear of the vehicle



4. Gently swing the convertible top downward and press until it engages audibly.



To close

1. Press button 1.
The convertible top is released and moves up slightly

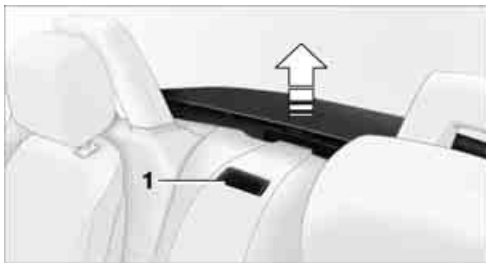

2. Holding on to the handle, pull the convertible top forward onto the windshield frame
3. Turn the handle until it audibly engages.
The convertible top is locked.

 At higher speeds, a vacuum effect in the passenger compartment can cause the convertible top to begin fluttering. Increase the air supply so that a low pressure draft does not occur in the vehicle. ◀

Fully automatic convertible top*

The fully automatic convertible top combines assured protection against the elements with simple and easy handling.

Here are a few tips so that you get the most out of your BMW:

- ▷ It is advisable to close the convertible top when the vehicle is parked. When closed,

the top not only guards the passenger compartment from unforeseeable damage from the weather, but also affords a degree of protection against theft. In addition, only keep valuables in the locked luggage compartment, even with the convertible top closed

- ▷ Never mount a roof-mounted luggage rack system on the convertible top
- ▷ To avoid damage, do not operate the convertible top at temperatures below 14 °F / -10 °C.

⚠ To avoid permanent damage from moisture, never store the convertible top while it is wet.

Driving when the opening or closing process has not been completed can cause vehicle damage or personal injury.

Do not lay objects on the convertible top, since they could fall off when the convertible top is operated and cause damage or injuries.

Do not reach into the convertible top mechanism during opening and closing. Keep children away from the moving parts of the convertible top during operation. ◀

▶ If possible, only operate the convertible top with the vehicle stopped, as otherwise the process may be interrupted.

If you set the convertible top in motion while the vehicle is stationary and then have to start suddenly, for instance at a traffic light, you can still complete the procedure by driving as slowly as possible and again holding the corresponding button pressed.

At higher speeds, a vacuum effect in the passenger compartment can cause the convertible top to begin fluttering. Increase the air supply so that a low pressure draft does not occur in the vehicle. ◀

Opening and closing

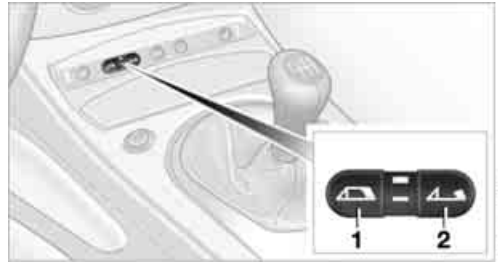

- 1 To close
- 2 To open

▶ If at all possible, only operate the convertible top if the engine is running. This saves unnecessary battery wear.

Before closing the convertible top, remove any objects from the windshield frame that could keep the convertible top from closing properly. ◀

Ignition key in position 1 or higher.

With the vehicle standing.

1. Read and comply with the preceding safety precautions
2. Make sure that the convertible top compartment panel in the luggage compartment is lowered; refer to page 19. Otherwise the convertible top cannot be opened
3. Ensure that the luggage compartment lid is closed
4. Press and hold the corresponding button for convertible top operation.

If the convertible top should halt right before the closing phase is completed, press against the front part of the convertible top frame from the outside to help the closing process along. Keep pressing the button while doing so until the top starts up again on its own.

Indicator lamps

- ▷ The red indicator lamp in the button will light up while the convertible top is in motion. It goes out as soon as the opening or closing operation has been completed
- ▷ If the red indicator lamp in the button flashes after the button has been released,

then the opening or closing operation has not yet been completed.

The sequence can be continued in the desired direction by pressing this button

- ▶ If the yellow indicator lamp in the button lights up continuously with the button pressed, then the convertible top compartment panel is raised and the convertible top cannot be moved.

The side windows will lower slightly when you press the button for operating the convertible top.

After the opening or closing operation, the side windows will go back up if you keep the button pressed for more than 2 seconds after the indicator lamp has gone out.

Interruption

The automatic sequence will be interrupted immediately if you release the button that operates the top. The sequence can be continued in the desired direction by pressing this button.

 If the convertible top operation has been interrupted, do not close the side windows using the power window buttons. Otherwise the side windows may not close properly against the rubber seal of the convertible top. ◀

 After the convertible top has been stored for an extended period of time in the convertible top compartment, e.g. in the winter months because the hardtop was being used, you may have to support the convertible top by hand when closing it for the first time. ◀

Convenience operation

Remote control

Refer to page 17.

Driver's door

Refer to page 18.

To close manually in the event of an electrical malfunction

1. Pull out the handle in the luggage compartment as far as it will go



2. Turn the handle 90° until it engages
3. Pull on the cord in the luggage compartment panel.

The storage compartment between the seat backrests is unlocked, refer also to page 64

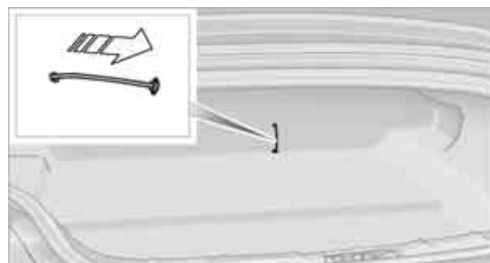

4. Press button 1.
The convertible top is released and moves up slightly

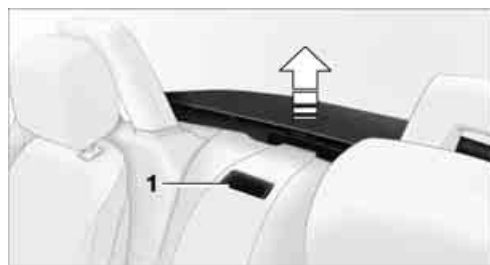

- Grab the convertible top at its frame and pull it up to the windshield frame



- Pull out the cover panel that is in the center of the front convertible top frame



- Insert the Allen wrench into the hex slot. The Allen wrench is located in the vehicle tool pouch, refer to page 91

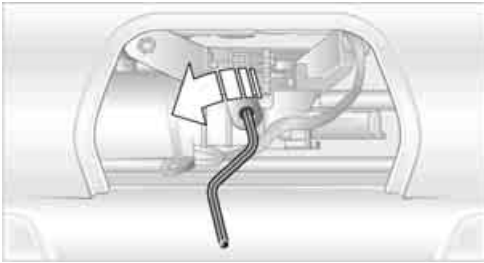

- Pull the convertible top frame down as far as possible
- Continue turning the Allen wrench to the left until the convertible top frame has locked onto the windshield frame.

Wind deflector*

With the convertible top open, the wind deflector keeps air movement in the passenger com-

partment to a minimum, thus providing you with a pleasant drive, even at higher speeds.

Installation



Insert the wind deflector in its proper orientation into the guides **1** provided on the rollover bars.

Refer to the labeling on the wind deflector to determine its proper orientation.

 The wind deflector must engage firmly, as it could otherwise become detached at higher vehicle speeds. ◀

The wind deflector panels **2** in the rollover bars cannot be removed.

Removal



Slide both locks inward and remove the wind deflector.

Clothes hooks



Clothes hooks **1** are located on the wind deflector panels in the rollover bars.

 Do not hang heavy objects on the hooks. If you do, they could endanger the passengers, for example during braking or evasive maneuvers. ◀

Storage

For storage, e.g. to achieve a better view to the rear when the convertible top is closed, there are two brackets on the inside of the luggage compartment lid.

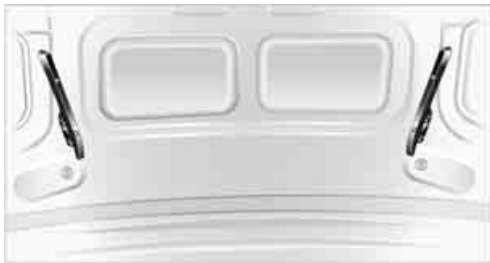

Insert the wind deflector into the brackets.

 Make sure that the wind deflector cannot be damaged by objects in the luggage compartment. ◀

Alarm system*

The concept

The vehicle alarm system responds:

- ▷ When a door, the hood or the luggage compartment lid is opened
- ▷ When attempts are made to start the vehicle
- ▷ When there are movements in the vehicle interior: interior motion sensor, refer to page 26
- ▷ To alterations in the vehicle tilt, e.g. as would occur during attempts to steal the wheels or tow the vehicle
- ▷ To interruption of battery voltage.

The alarm produced by the system in the event of unauthorized vehicle entry and attempted theft depends on the country version:

- ▷ Sounding of an acoustical alarm for 30 seconds
- ▷ Activation of the hazard warning flashers for approx. five minutes.

Arming and disarming the alarm system

When the vehicle is locked or unlocked either with the remote control or at the driver's door lock, the alarm system is simultaneously armed or disarmed.

The hazard warning flashers blink once when the alarm system has been properly armed.

 You can have different acknowledgment signals set to confirm arming and disarming. ◀

You can still open the luggage compartment even when the system is armed by pressing the  button on the remote control, refer to page 17. When it is closed, the lid is once again secured.

 Manual operation of the luggage compartment lid triggers the alarm. Refer to page 18. ◀

Stopping the alarm

- ▷ Unlock the vehicle with the remote control, refer to page 16
- ▷ or turn the ignition key to position 1, refer to page 36.

Indicator lamp displays



- ▷ The indicator lamp beneath the interior mirror flashes continuously:
The system is armed
- ▷ The indicator lamp flashes immediately after the vehicle is locked:
Doors or luggage compartment lid are not completely closed. Even if you do not close the area causing the alert, the remaining areas are secured and the indicator lamp flashes continuously after 10 seconds. However, the interior motion sensor is not activated
- ▷ If the indicator lamp goes out immediately after the vehicle is unlocked:
No manipulation or attempted intrusions have been detected in the period since the system was armed
- ▷ If the indicator lamp flashes for 10 seconds immediately after the vehicle is unlocked:
An attempted entry has been detected in the period since the system was armed.

After an alarm has been triggered, the indicator lamp will flash continuously.

Tilt alarm sensor and interior motion sensor

Tilt alarm sensor

The inclination of the vehicle is monitored. The alarm system reacts, e.g. to attempts to steal the wheels or tow the vehicle.

Interior motion sensor*

The system monitors the footwells and the seating areas of the driver and passenger. Even when the convertible top is open, the alarm system including the interior motion sensor is armed. Objects falling into the vehicle, e.g. leaves, can trigger unintentional alarms, refer to Avoiding unintentional alarms.

Avoiding unintentional alarms

The tilt alarm sensor and interior motion sensor can be deactivated at the same time. In this way you can avoid unintentional alarms, e.g. in the following situations:

- ▷ In duplex garages
- ▷ When the vehicle is being transported on a car-carrying train
- ▷ If animals are to be left in the vehicle.

To deactivate the tilt alarm and interior motion sensors

Press the  LOCK button on the remote control a second time immediately after locking.

The indicator lamp lights up briefly and then flashes continuously. The tilt alarm sensor and the interior motion sensor are deactivated until the vehicle is again unlocked and locked.

Adjustments

Safe seating position

For relaxed driving with as little fatigue as possible, you should select a seating position that reflects your personal requirements. In combination with the safety belts and airbags, the correct seating position also plays an important role in enhancing occupant safety in the event of an accident. To ensure that the vehicle's safety systems provide you with optimal protection, we request that you direct your careful attention to the following section.

For supplementary information on transporting children refer to page 33.

Airbags

 Always maintain an adequate distance between yourself and the airbags. Always hold the steering wheel by its rim with hands at the 9 and 3 o'clock positions to minimize the risk of injuries to your hands or arms in the event of airbag deployment.

Never allow any objects, individuals or animals to obstruct the areas between passengers and airbags.

Never use the front airbag's cover as a storage tray or support for objects of any kind. Ensure that the passenger is correctly seated, i.e. does not prop feet or legs against the dashboard.

Otherwise, leg injury could result if the knee airbag and front airbag suddenly deployed.

Never let an occupant's head rest near or on a side airbag because the inflating airbag could cause a serious or fatal injury. ◀

Even when all these guidelines are observed, the risk of injury as a result of contact with the airbags cannot entirely be ruled out in some situations. In sensitive individuals, the ignition and inflation noise may induce a mild hearing loss that is temporary in most cases.

For airbag locations and additional information on airbags, refer to page 53.

Safety belts

Always fasten your safety belt before starting off. As supplemental restraint devices, the airbags are designed to enhance the effectiveness of the safety belts, and not to replace them.

Your vehicle offers two sitting positions, each of which is equipped with a safety belt.

 At all times, occupants should sit upright and be properly restrained: infants and small children in appropriate child-restraint systems; larger children and adults using the safety belts.

Expectant mothers should always wear their safety belts, taking care to position the belt in the pelvic area against the lower hips, where it will not exert pressure against the abdomen. Never allow more than one person to wear a single safety belt. Never allow infants or small children to ride in a passenger's lap.

Do not route the belt across your neck, or run it across sharp edges. Be sure that the belt does not become caught or jammed. Avoid twisting the belt while routing it firmly across the hips and shoulder; wear it as snugly against your body as possible. Do not allow the belt to rest against hard or fragile objects. Otherwise, the belt in the pelvic area could slide over the hips in the event of a frontal impact, leading to abdominal injury. Avoid wearing bulky clothing and pull the belt in the upper-body area upward periodically to retension it. Otherwise, the restraining effect of the safety belt could be diminished. ◀

For information on using the safety belts, refer to page 30.

Seats

Before adjusting your seat, always observe the following precautions

⚠ Never try to adjust your seat while operating the vehicle. The seat could respond with an unexpected movement, and the ensuing loss of vehicle control could result in an accident.

Never ride with the backrest inclined to an extreme angle – this also applies to the passenger seat. If you do, there is a risk that you will slide under the safety belt in the event of an accident, thus reducing the protection provided by the safety belt. ◀

In addition, observe the instructions regarding damaged safety belts on page 30.

Seat adjustment

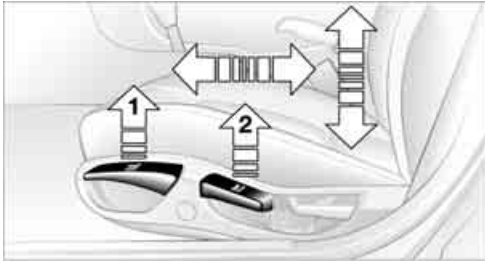

1 Backward/forward

Pull lever **1** and slide the seat into the desired position.

After releasing the lever, move the seat backwards or forwards slightly to ensure that the latch engages securely

2 Height

Pull lever **2** and apply weight to or remove weight from the seat as required

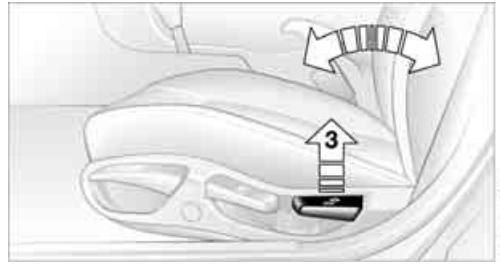

3 Backrest

Pull lever **3** and apply weight to or remove weight from the backrest as required.

Head restraints

⚠ Head restraints reduce the risk of neck injuries in the event of an accident. Adjust the head restraint in such a way that its center is at approximately ear level. ◀

Adjusting the height

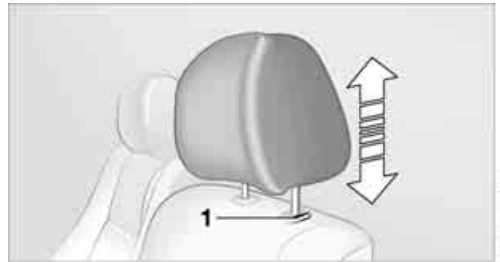

- ▷ To move up: pull.
- ▷ To move down: press button **1** and push the head restraint downward.

Removal

1. Pull up the head restraint as far as it will go.
2. Press button **1** and pull out the head restraint completely.

Installation

Insert the head restraint into the guides.

Seat adjustment: M Sports seat*

You can also adjust the tilt and the thigh support.



1 Tilt upward

Pull the lever repeatedly until the desired tilt has been reached.

2 Tilt downward

Push the lever repeatedly until the desired tilt has been reached.

3 Thigh support

Pull the lever and adjust the position of the cushion for thigh support as desired.

Power seat adjustment*



- 1 Tilt angle
- 2 Backward/forward adjustment
- 3 Height
- 4 Backrest angle

The head restraints are adjusted manually. Refer to page 28.

With the M Sports seat, you can also adjust the thigh support manually, refer to the preceding section.

 Read and comply with the adjustment instructions on page 28. Failure to do so can result in diminished personal safety. ◀

Seat memory*

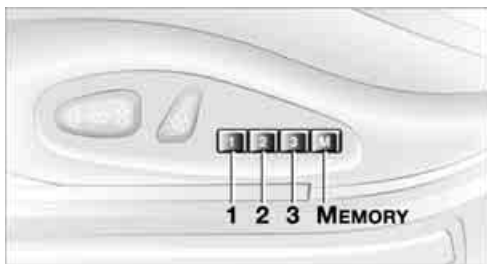

You can store and recall three different driver's seat positions.

To store

Ignition key in position 1 or higher

1. Adjust seat to desired position
2. Press the **MEMORY** button: the indicator lamp in the button lights up
3. Press memory button **1, 2 or 3**: the indicator lamp goes out.

To select a stored setting

 Do not select a memory position while the vehicle is moving. If you do, there is a risk of accident from an unexpected movement of the seat. ◀

Convenience function

1. Unlock and open the driver's door or turn the ignition key to position 1
2. Press memory button **1, 2 or 3** briefly. Movement stops immediately when one of the seat adjustment or memory buttons is operated during the adjustment process.



You can have this feature programmed so that when you use the remote control from your personalized key to unlock your door, your seat will move into your own preferred position. ◀

Safety function

1. Close the driver's door and turn the ignition key to position 0 or 2
2. Press and hold the desired memory button **1**, **2** or **3** until the adjustment process is completed.

If you press the **MEMORY** button accidentally: Press the button again; the indicator lamp goes out.

 Before activating the programmed adjustment feature, ensure that the space behind the driver's seat is empty and unobstructed. If you fail to do so, objects behind the seat could be damaged, should the seat move backward. ◀

Seat heating*

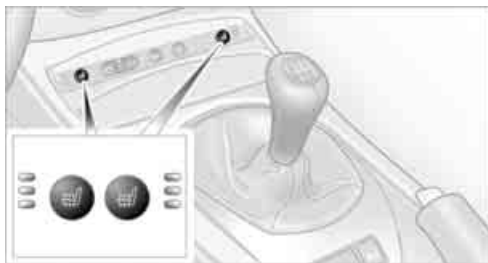

The seat cushion and backrest can be heated with the ignition key in position 2.

You can call up different heating modes by repeatedly pressing the buttons.

The seat heating can also be switched off from the higher heating modes: Press the button and hold it slightly longer.

Safety belts

 Comply with the instructions on page 27, or the occupants' personal safety will be diminished. ◀

Make sure every occupant fastens his or her safety belt. As supplemental restraint devices, the airbags are designed to enhance the effectiveness of the safety belts, and not to replace them.

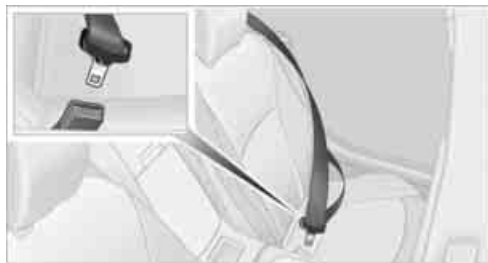

To fasten

Make sure you hear the lock engage in the belt buckle.

To unlock

1. Press the red button in the belt buckle
2. Hold the belt
3. Guide the belt back into its reel.

The upper belt attachment point is suitable for all body sizes, provided that the person is sitting correctly, refer to page 28.

Safety belt reminder



The indicator lamp flashes or lights up. A signal also sounds. Check if the safety belts have been properly fastened.

The safety belt reminder is operational above a speed of approx. 5 mph / 8 km/h. The reminder can also occur if objects are on the passenger seat.

Damaged safety belts

 If the safety belts are damaged or stretched in an accident: have the entire belt system, including the tensioning mechanisms, replaced at your BMW center. Have the belt anchorage points inspected for damage at the same time. Failure to observe this precaution may prevent the safety belts from effectively providing optimal protection when needed. ◀

Steering wheel

Adjustments

 Never attempt to adjust the steering wheel while driving the vehicle. It could respond with unexpected movement, posing a potential accident hazard. ◀

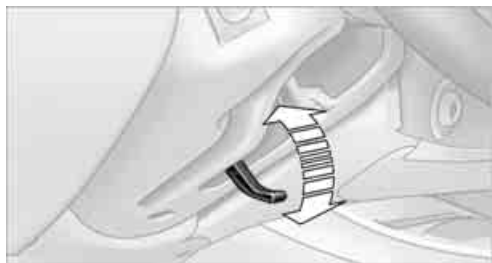

1. Swing the lever downward
2. Adjust the steering column's reach and height to suit your seating position
3. Swing the lever back up.

Mirrors

Exterior mirrors

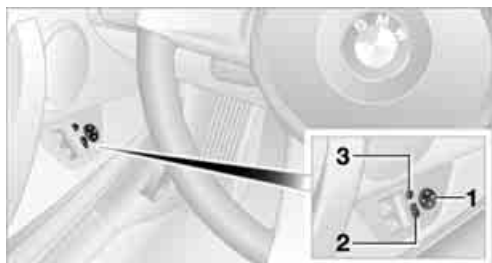

- 1 Adjustments
- 2 To switch from one mirror to the other
- 3 To fold the mirrors in or out*

To adjust manually

The mirrors can also be adjusted manually, if necessary: press on the edges of the lens.

To fold the mirrors in and out

The mirrors can be folded in or out up to a road speed of approx. 6 mph / 10 km/h by pressing button **3**. This can be useful on narrow roads, for example, or to reset the mirrors to their correct positions after they have been folded in.

Automatic heating*

Both exterior mirrors are automatically heated when the engine is running or the ignition is switched on.

Interior rearview mirror



To reduce the glare from vehicles behind you when driving at night, turn the rotary knob. For vehicles without an alarm system: Tilt the small lever forward.

Vehicle Memory, Key Memory

How the system functions

You have probably frequently wished that you could configure individual functions of your vehicle to reflect your own personal requirements. In engineering your vehicle, BMW has incorporated a number of options for personal adjustment that can be programmed into your vehicle at your BMW center.

Vehicle Memory refers to vehicle-oriented settings and Key Memory refers to person-oriented settings. You can have up to four different basic settings adjusted for four different persons. The only requirement is that each person uses his or her own remote control key.

When your vehicle is unlocked with the remote control, the vehicle recognizes the individual

user by means of a data exchange with the key, and makes adjustments accordingly.

Colored decals were provided with the keys to help you distinguish between the different personal remote control keys.

What the system can do

You can learn about the entire array of features that Vehicle Memory and Key Memory offer you at your BMW center. A few examples follow below:

Examples for Vehicle Memory:

- ▷ Various signals as acknowledgement when locking or unlocking your vehicle: refer to page 17
- ▷ Windows are opened automatically, refer to page 20
- ▷ Reminder that the key is still in the ignition switch after the driver's door has been opened, refer to page 37
- ▷ Activation/deactivation of the Follow-me-home function: refer to page 56
- ▷ Activation/deactivation of daytime driving lamps: refer to page 56
- ▷ Sets the units of measure for displaying time, outside temperature, distance traveled and fuel consumption in the instrument cluster, refer to page 48.

Examples for Key Memory:

- ▷ Locking of the vehicle when you start off: refer to page 18
- ▷ Automatically adjusts the driver's seat to the personal programmed settings when the vehicle is unlocked, refer to page 29.



You will see this symbol throughout the Owner's Manual. It is to remind you at appropriate places of the settings that are available to you. ◀



Depending on how the memory functions are configured, the vehicle may be operated differently from what is described in the Owner's Manual. Should you decide to sell your BMW one day, please remember to have the memory functions returned to their original factory settings. ◀

Transporting children safely

Children on the passenger's seat

Deactivating/reactivating passenger airbags

 The passenger airbags must be deactivated before using a rear-facing child-restraint system on the passenger seat, refer also to page 34 for explanation.

BMW also recommends that the passenger airbags be deactivated if a child is transported in a front-facing child-restraint system, regardless of the age of the child. If you transport a child in the passenger seat, not an infant in a rear-facing seat, who is properly seated and seat-belted at all times, the potential benefits of airbags deploying in an accident generally outweigh the risks of the child being injured by the force of a deploying airbag.

Therefore, you should deactivate the passenger airbags only if you find it difficult to ensure that the child will remain properly seated and seat-belted at all times.

Always position the passenger seat as far back as possible and at the lowest level.

The above warning and recommendations are compatible with regulations established by the National Highway Traffic Safety Administration, NHTSA, permitting the deactivation of passenger airbags by means of an on-off switch for members of certain at-risk groups.

Specifically, the at-risk groups are:

- ▷ Infants in rear-facing infant seats
- ▷ Persons with certain medical conditions
- ▷ Children aged 12 and under in the passenger seat.

NHTSA provides this information via their website, www.nhtsa.dot.gov, or via their Auto Safety Hotline toll-free at 1-800-424-9393 or 366-0123 in Washington, D.C. area. ◀

The concept

Passenger airbags can be deactivated/reactivated with the vehicle ignition key. The key switch is located on the outer passenger's side of the instrument panel.

The passenger airbags can only be deactivated or reactivated with the vehicle standing still, ignition off and the passenger door open.

Deactivation



Deactivation of the passenger airbags system deactivates the passenger front, knee and side airbag. The airbags on the driver side remain active.

Using the vehicle ignition key, turn the key switch to the OFF position. Note, the passenger airbags will remain deactivated with the switch in this position.

 As soon as the reason for the deactivation of the passenger airbags no longer exists, you must reactivate these airbags so that they can deploy in an accident within their normal deployment range. ◀

Reactivating

Using the vehicle ignition key, turn the key switch to the ON position.

All airbags in the vehicle are activated and will be triggered under appropriate conditions.

Passenger airbags lamp



The center console contains one of the indicator lamps shown in the illustration.

The system checks that the airbag system is functioning properly when the ignition key is turned, and the indicator lamp in the central console lights up for several seconds.

- ▷ The indicator lamp lights up continuously when the passenger airbags are deactivated
- ▷ If the passenger airbags are activated, it goes out after several seconds

▷ The passenger airbags are deactivated when the key switch is in the ON position and the passenger seat is unoccupied. The indicator lamp is not lit. ◀

⚠ At all times, occupants should sit comfortably upright and be properly restrained: infants and small children in appropriate child-restraint systems; larger children and adults using the safety belts. Please note that the word Airbag imprinted on the door trim panel indicates the airbag's location. ◀

Seating position for children



This is the correct way a larger child no longer using a child-restraint system should sit wear-

ing the safety belt, when the airbag system is activated.

Installing child-restraint systems

Before installing any child-restraint system or child seat, read the following:

⚠ Never install a rear-facing child-restraint system in the passenger seat of this vehicle, unless the passenger airbags have been turned off and the indicator lamp in the center console indicates that the passenger airbags are deactivated. For a child, not an infant, certain precautions should be taken. Position the passenger seat as far back as possible and at the lowest level. This important precaution is intended to maximize the distance between the airbags and the child. Younger children should be secured in an appropriate forward-facing child-restraint system that has first been properly secured. Older children should be tightly secured with a safety belt, sitting with their back against the vehicle seat back. Always ensure that all occupants, of all ages, remain properly and securely restrained at all times. ◀

⚠ Always follow the manufacturer's instructions concerning installation and use; otherwise the system's protective function could be impaired. After an accident, have all parts of the affected safety belt system inspected and/or replaced by your BMW center. ◀

Commercially-available child-restraint systems are designed to be secured with a lap belt or with the lap belt portion of a combination lap/shoulder belt. Improperly or inadequately installed restraint systems can increase the risk of injury to children. Always read and follow the instructions that come with the system.

Child seat security



The passenger's safety belt can be locked for mounting and securing a child-restraint system.

A label with the appropriate instructions for this is located in the immediate vicinity of the buckle latch of the safety belt.

LATCH child-restraint mounting system*

 To mount the LATCH child-restraint system, please follow the manufacturer's operating and safety precautions. ◀

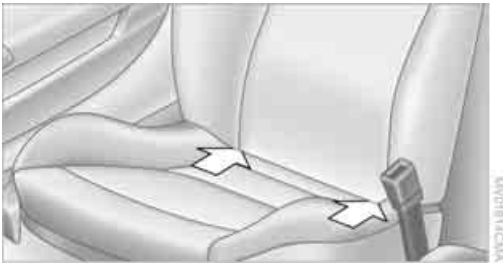

LATCH: Lower Anchors and Tethers for Children

The anchorage points for the LATCH child-restraint system are located at the positions indicated by the arrows.

Carefully slide the brackets through the gaps in the upholstery at the indicated locations, see arrows.

Driving

Ignition lock

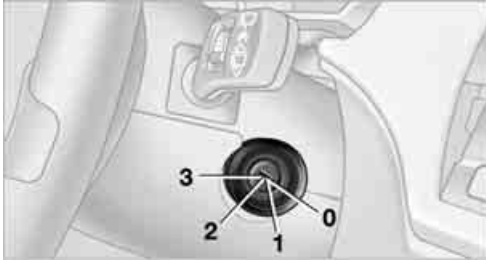

0 Steering locked

This is the only position in which the ignition key can be inserted or removed.

After removing the key, turn the steering wheel slightly to the left or right until the lock engages.

If the key is not removed, an acoustic signal sounds when the driver's door is opened.

Interlock

Vehicles with automatic transmission:

In order to turn the key back to position **0** or to remove it, move the selector level into position **P** first.

1 Steering unlocked

You will find that it is often easier to turn the ignition key from position **0** to **1** if you move the steering wheel slightly to help disengage the detent.

Individual electrical equipment and accessories are available for use.

2 Ignition switched on

All systems are operational.

3 Starting engine

Engine

Engine idle speed is controlled by the engine computer system. Increased speeds at start-up

are normal and should decrease as the engine warms up. If engine speed does not decrease, service is required.

To prevent the battery from discharging, always deactivate electrical devices that are not in use. Switch the ignition off when the vehicle is not being driven.

 Do not leave the engine running in enclosed spaces. Otherwise, inhaling the hazardous exhaust gases could lead to unconsciousness and death. The exhaust gases contain carbon monoxide, an odorless and colorless, but highly toxic gas.

Do not leave the vehicle unattended with the engine running. An unattended vehicle with a running engine poses a safety hazard.

Before you leave the vehicle with the engine running, place the engine in idle first or engage the **P** position and apply the parking brake. If you fail to do this, the vehicle could move. ◀

Starting the engine

Do not press the accelerator pedal while starting the engine.

Do not let the engine warm up in idling position. Instead, begin to drive at moderate engine speeds.

 Vehicles with manual transmission: Step on the clutch when starting the vehicle. A lockout prevents the engine from starting if the clutch is not depressed. ◀

Do not end the starting procedure too early, but do not continue it for more than 20 seconds. Release the ignition key immediately when the engine starts.

If the engine fails to start on the first attempt, e.g. if it is very hot or cold:

Press the accelerator pedal halfway down.

Cold starts at very low temperatures, below approx. +5 °F / -15 °C, and at high altitudes, above 3,300 ft/1,000 m:

- ▷ On the first attempt, engage the starter for approx. 10 seconds
- ▷ Press the accelerator pedal halfway down.

 Avoid frequent starting attempts in short succession or repeated starting attempts during which the engine does not start. Otherwise, uncombusted or incompletely combusted fuel will pose a risk of the catalytic converter overheating and being damaged. ◀

Manual transmission

1. Engage the parking brake
2. Gearshift lever in idling position
3. Depress the clutch pedal.
If the clutch pedal is not depressed, the engine cannot be started
4. Start the engine.

Automatic transmission

1. Depress footbrake
2. Place selector lever in position P or N
3. Start the engine.

Sequential manual gearbox SMG

1. Depress footbrake
2. Move selector lever to neutral position N
3. Start the engine.

 If the engine does not start, re-engage the position last selected, refer to the display in the instrument cluster, and then engage position N again. ◀

Switching off the engine

 Do not remove the ignition key while the vehicle is still moving. If you did so, the steering lock would engage when the steering wheel is turned.

When you leave the vehicle, always remove the ignition key and engage the steering lock. Apply the parking brake when parking on steep gradients, as the vehicle could otherwise start to roll. ◀

 You can have an acoustic signal set as a reminder that the ignition key is still in the

ignition switch after the driver's door has been opened. ◀

Manual transmission

1. Turn the ignition key to position 1 or 0
2. Engage first gear or reverse gear.

Automatic transmission

1. Place the selector lever in position P
2. Turn the ignition key to position 1 or 0.

Sequential manual gearbox SMG

1. Engage a drive position
2. Turn the ignition key to position 1 or 0. An acoustic signal sounds if the engine is switched off while position N is engaged.

Parking brake

The parking brake is designed primarily to prevent the vehicle from rolling when parked. It operates against the rear wheels.

 The indicator lamp lights up. As the vehicle drives off, an acoustic signal also sounds. The parking brake has been applied.

 Indicator lamp for Canadian models.

To engage

The detent engages automatically and the indicator lamp in the instrument cluster comes on when the ignition key is in position 2.

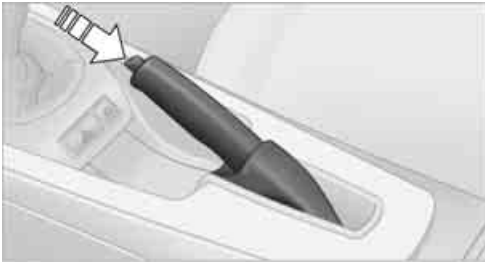

To release

Pull up slightly on the lever, press the button and lower the lever.

⚠ If, in exceptional circumstances, it should be necessary to engage the parking brake while the vehicle is in motion, do not pull it with excessive pressure. Keep the release button on the parking brake lever pressed down while pulling up the lever.

Excessive pressure can lead to overbraking and loss of traction, fishtailing, at the rear axle. The brake lamps do not come on when the parking brake is engaged. ◀

▶ To avoid corrosion and one-sided braking, apply the parking brake lightly from time to time when coasting to a standstill at a traffic signal, for example, provided that it is safe to do so. ◀

Manual transmission

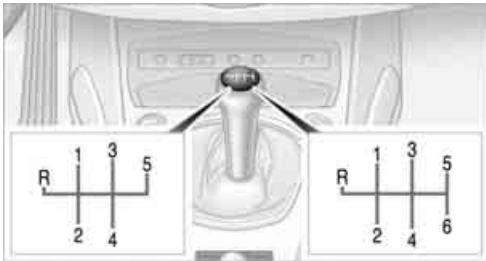

6-gear transmission*

⚠ When shifting into 5th or 6th gear, press the gearshift lever to the right. Otherwise, the engine could be damaged by accidentally engaging 3rd or 4th gear. ◀

Reverse

Select only when the vehicle is stationary. Press the gearshift lever to the left to overcome the resistance.

As you do this, the backup lamps will come on automatically when the ignition key is in position 2.

Automatic transmission with Steptronic*

In addition to operating the Steptronic as a fully automatic transmission, you can also shift gears manually with it, refer to page 39.

Selector lever positions

P R N D M/S + —

Available indicators



P R N D SD M1 to M5

The selector lever position is displayed; in the manual mode, the gear currently engaged is shown.

Range selection

- ▷ The selector lever can be moved out of position P when the ignition is switched on or the engine is running: interlock
- ▷ While the vehicle is stationary and before shifting out of P or N, depress the footbrake in order to disengage the selector lever's lock mechanism: shiftlock.

Hold the footbrake down until starting off. The vehicle will otherwise start to move when a drive position is engaged.



A detent prevents inadvertent shifting into selector lever positions R and P. To disengage the detent, press the button on the front of the selector lever knob, see arrow.

P Park

Select only when the vehicle is stationary. The transmission locks to prevent the rear wheels from turning.

R Reverse

Select only when the vehicle is stationary.

N Neutral

Select this, for example, in car washes. The vehicle can roll.

D Drive, automatic shift program

This position is designed for driving under all normal operating conditions. All forward gears are available.

Kickdown

With kickdown, you achieve maximum acceleration performance. Depress the accelerator pedal past the increased resistance point at the full-throttle position.

M/S Manual mode and Sport program



Move the selector lever from position D to the left into the M/S range:

The Sport program is activated. This is indicated by the display SD in the instrument cluster. This position is recommended for performance-oriented driving. The Sport program is enabled automatically when the Driving Dynamic Control system is activated, refer to page 41.

Steptronic enters the manual selection mode and executes the desired shift whenever you tap the selector lever in the direction indicated by + or -. M1 to M5 appear in the instrument cluster.

The transmission will only execute upshifts and downshifts that will result in an appropriate combination of vehicle speed and engine rpm. For instance, downshifts that would result in excessive engine speed will not be executed. The desired gear will appear briefly in the instrument cluster, followed by the actual gear.

To use the automatic transmission mode again, move the selector lever to the right to position D.

Malfunction



The warning lamp lights up. The transmission system is malfunctioning. Avoid heavy loads.

All of the selector lever positions can continue to be engaged; in the forward drive positions, however, the vehicle will be operating in a restricted gear range only. Have the system checked immediately.

Towing and jump starting beginning with page 97.

Sequential manual gearbox SMG*

The concept

The sequential manual gearbox SMG is an automated manual gearbox with which clutching and shifting is assumed by an electro-hydraulic system.

The SMG is operated via two shift paddles on the steering wheel and the selector lever in the center console.

It offers the following functions:

- ▷ Optionally manual or automatic operation: sequential mode or drive mode
- ▷ Ability to choose between two different driving programs: standard or Sport, refer to page 41
- ▷ Protection against misshifting, and automatic downshifting at minimum engine rpm even in sequential mode
- ▷ Kickdown function in the drive mode
- ▷ Acceleration assistant, refer to page 42.

The SMG is ready for operation when the ignition key is in position 2.

Selector lever positions



You can see the current selector lever position in the center console.

- ▷ R: Reverse
- ▷ N: Neutral
- ▷ One-touch functions for the sequential mode
 - +: manual upshifting
 - : manual downshifting

- ▷ D: Drive mode.

▷ N is automatically selected if the driver's door is opened while the engine is running and the driver does not actuate the pedals, the shift paddles or the selector lever. This is accompanied by an acoustic signal and a flashing N in the instrument cluster. ◀

Gear indicator



R N 1 to 6

The gear currently engaged is displayed; in the Drive mode, a D appears in front of the gear

Shiftlock

While the vehicle is stationary and before shifting out of N, depress the footbrake, as otherwise the desired gear shift is not executed.

R Reverse

Select only when the vehicle is stationary.

Sequential mode

Each time the engine is started, the sequential mode is activated as soon as you move the selector lever towards the right while depressing the brake pedal.

The gear is changed via the shift paddles or the selector lever.

It is also possible to drive off in second gear, e.g. on slippery roads.

D Drive mode

In the drive mode all forward gears are shifted automatically.

To switch from sequential to drive mode: tap the selector lever to the right toward D.

Kickdown:

For rapid acceleration, e.g. during passing, depress the accelerator pedal completely. You achieve maximum acceleration.

To switch back to sequential mode: tap the selector lever again to the right toward D, or change the current gear via the shift paddles or the selector lever.

 When driving off on inclines, drive smoothly without pausing. Do not keep the vehicle in place by depressing the accelerator pedal; instead, apply the parking brake. Otherwise, the gearbox could overheat. ◀

Shifting gears

With selector lever

- ▷ To upshift, tap the selector lever toward +
- ▷ To downshift, tap the lever toward –.

With shift paddles on steering wheel

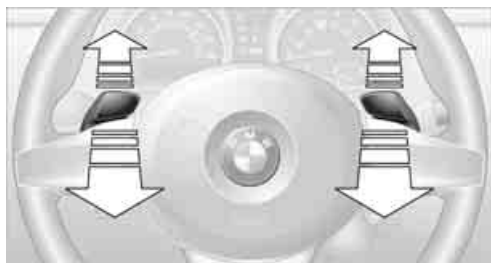

- ▷ To upshift, pull one of the shift paddles
- ▷ To downshift, push the paddle.

In the following situations, the SMG in the sequential mode assists you:

- ▷ The transmission will only execute upshifts and downshifts that will result in an appropriate combination of vehicle speed and engine rpm. For instance, downshifts that would result in excessive engine speed cannot be executed
- ▷ During a stop the gearbox is automatically downshifted into first gear
- ▷ Shortly before a gear-dependent minimum speed is reached, the gearbox automatically shifts down without you taking any action.

Malfunction



The warning lamp lights up. The transmission system is malfunctioning.

Avoid heavy loads.

All of the selector lever positions can continue to be engaged; in the forward drive positions, however, the vehicle will be operating in a restricted gear range only. Have the system checked as soon as possible.

Towing and tow-starting, refer to page 98; Jump starting, refer to page 97.

Overheating

An acoustic warning signal sounds. The gearbox is overheating. If possible, stop the vehicle or drive off swiftly so that the system can cool off again.

Driving Dynamic Control

Driving Dynamic Control allows your BMW to react in a sportier driving style at the touch of a button:

- ▷ The engine responds more spontaneously to any motion of the accelerator pedal
- ▷ The vehicle is steered more directly and traction is enhanced
- ▷ Cruise control: When the speed last stored is called up, this speed is attained more quickly.

Additional features with SMG:

- ▷ Gears are shifted more quickly
- ▷ The engine speed range is optimally utilized in the drive mode.

With automatic transmission:

- ▷ The Sport program is activated.

To activate the system



Ignition key in position 2
Press the SPORT button.
The LED in the button lights up.

To deactivate the system

Press the SPORT button again.
The LED in the button goes out.

Acceleration assistant with SMG

The acceleration assistant permits optimum racing-style acceleration on skid-resistant roads.

 Do not use the acceleration assistant too often, as this could cause the vehicle's parts to wear prematurely. ◀

1. Activate Driving Dynamic Control
2. Press the DTC button, refer to page 51, for more than three seconds
3. Depress the accelerator all the way down rapidly: kickdown. The optimum rpm for driving off will be adjusted.

 To maintain vehicle stability, drive with the DSC switched on whenever possible. ◀

Electric Power Steering EPS

The concept

The electric power steering is a direct, sporting steering system that is speed-sensitive. Power support is reduced with an increase in driving speed.

Malfunction



The indicator lamp stays lit:
The system has malfunctioned or is faulty.

Steering remains operational.
Have the system checked as soon as possible.

Turn signal indicators/ Headlamp flasher

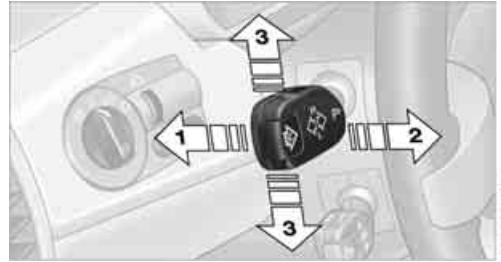

- 1 High beams
- 2 Headlamp flasher
- 3 Turn signal indicators

 If the flashing of the indicator lamp and the clicking from the relay are both faster than normal, one of the turn signal indicators has failed. ◀

To signal briefly

Press the lever up to the detent but not beyond. It then returns to the center position when released.

Washer/wiper system



- 0 Wipers retracted
- 1 Intermittent operation or rain sensor*
- 2 Normal wiper speed
- 3 Fast wiper speed
- 4 Brief wipe
- 5 To set interval time or sensitivity of the rain sensor

Intermittent operation or rain sensor*

In vehicles equipped without a rain sensor, the wipe interval is predefined.

The interval time can be set over four stages. In addition, the wipe interval is varied automatically depending on road speed.

On vehicles with a rain sensor, the wipe interval is automatically controlled according to rain intensity. You can adjust the sensitivity of the rain sensor. It is positioned on the windshield, directly in front of the interior rearview mirror.

To activate intermittent operation or rain sensor

Ignition key in position 1 or higher:
Lever to position 1.

In any case, the wipers will move once across the windshield.

In vehicles equipped with a rain sensor, you can leave the lever continuously in position 1. Then, as long as the ignition key is in position 1 or higher, you only need to activate the rain sensor.

Turn rotary dial 5 briefly.

To set interval time or sensitivity of the rain sensor

Turn rotary dial 5.

To deactivate intermittent operation or rain sensor

Return lever to position 0.

 Turn the rain sensor off in automatic car washes. Failure to do so could result in damage caused by undesired wiper activation. ◀

Normal wiper speed

When the vehicle is stopped the wipers switch to intermittent wipe, except in vehicles without rain sensor.

Fast wiper speed

When the vehicle is stopped the wipers switch to normal wiping speed, except in vehicles without rain sensor.

Cleaning windshield and headlamps*



- 0 Wipers retracted
- 1 Cleaning windshield and headlamps*

The system sprays washer fluid against the windshield and activates the wipers for a brief period.

If the vehicle's lights are on, the headlamps are cleaned at reasonable intervals.

 Do not use the washers if there is any danger that the fluid will freeze on the windshield, otherwise vision could be obscured. Therefore, use antifreeze, refer to page 86.

Do not use the washers if the fluid reservoir is

empty, as the washer pump will otherwise be damaged. ◀

Windshield washer nozzles

The windshield washer nozzles are automatically heated* when the engine is running or the ignition is switched on.

Cruise control*

 Do not use cruise control when unfavorable conditions make it inadvisable to drive at a constant speed. Otherwise, the vehicle could go out of control and an accident could be caused. Unfavorable conditions include, for example, twisting roads, high traffic density, or adverse road conditions such as snow, rain, ice, or loose surfaces. ◀

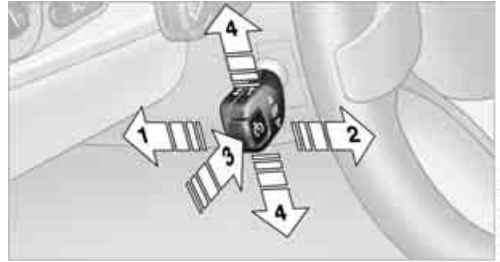

- 1 To maintain, store and increase speed
- 2 To maintain, store and decrease speed
- 3 To recall the stored speed
- 4 To deactivate the system

To maintain, store and increase speed

Above approx. 20 mph / 30 km/h you can maintain and store any desired speed.

Press the lever briefly in direction **1**:

The system maintains and stores the current vehicle speed. Every time you tap the lever, the speed increases by approx. 0.6 mph / 1 km/h.

Hold the lever in position **1**:

The vehicle accelerates without pressure on the accelerator pedal. As soon as you release the lever, the system stores and maintains the current speed.

 If, on a downhill grade, the engine braking effect is not sufficient, the controlled speed can be exceeded. Speed can drop on uphill grades if the engine output is insufficient. ◀

To maintain, store and decrease speed

Press the lever briefly in direction **2**:

When the cruise control is active, vehicle speed

is reduced by approx. 0.6 mph / 1 km/h every time you tap the button.

Hold the lever in position **2**:

With the cruise control active, the system automatically reduces the throttle opening to slow the vehicle. As soon as you release the lever, the system stores and maintains the current speed.

To recall the stored speed

Press the lever briefly in direction **3**:

The vehicle accelerates to and maintains the last speed stored.

To deactivate the system

Press the lever briefly in direction **4**:

The cruise control is deactivated immediately.

In addition, the system is automatically deactivated in response to the following conditions:

- ▷ When you apply the brakes
- ▷ When you depress the clutch or move the automatic selector lever from D to N
- ▷ If you exceed or fall below the preset speed for an extended period, for example by depressing the accelerator
- ▷ If DSC is in action.

You can recall the speed last stored.

Cruise control is also deactivated when the ignition key is turned to position 0.

The stored speed is cleared in this case.

Everything under control

Odometer



- 1 Odometer
- 2 Trip odometer

Odometer

With the ignition key in position 0, you can activate the displays shown in the illustration by pressing the button – see arrow – in the instrument cluster.

Trip odometer

To set to zero

Ignition key position 1

Keep the button pressed until the trip odometer counter is set to zero.

Tachometer



Never allow the engine to operate with the needle in the red overspeed sector of the gauge.

To protect the engine, the fuel supply is interrupted when you approach this sector.

Fuel gauge

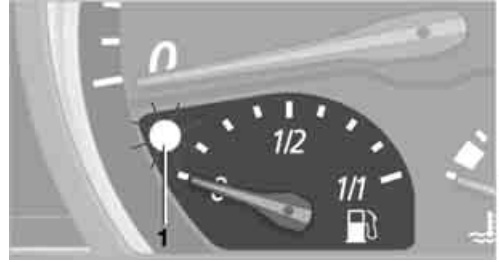

When indicator lamp 1 begins to stay on continuously, there are still approx. 2.1 gallons/8 liters of fuel in the fuel tank.

Tank capacity: approx. 14.5 gallons/55 liters.

If the tilt of the vehicle varies, for example when you are driving in mountainous areas, the needle may fluctuate slightly.

⚠ Fill the fuel tank well before it is empty. Driving to the last drop of fuel can prevent the engine from operating properly and result in damage. ◀

When you switch on the ignition, the indicator lamp comes on briefly to indicate an operational check.

Engine coolant temperature gauge



Blue

The engine is still cold. Drive at moderate engine and vehicle speeds.

Between the blue and red zones

Normal operating range. The needle may rise as far as the edge of the red sector during normal operation.

Red

When you switch on the ignition, warning lamp **1** comes on briefly to indicate an operational check.

Comes on while driving:

The engine has overheated. Stop and switch the engine off immediately and allow it to cool down.

For checking the coolant level, refer to page [87](#).

Service interval display



Remaining distance to next service

The displays shown in the illustration appear for a few seconds when the ignition key is in position 1 or after the engine is started.

The next service due appears with the message OIL SERVICE or INSPECTION, together with the distance remaining in miles – in kilometers in Canada – before the next scheduled service. The computer bases its calculations of the remaining distance on the preceding driving style.

A flashing message and a minus sign in front of the number mean that the service interval has already been exceeded by the distance shown on the display. Please contact your BMW center for an appointment.

Outside temperature



If the vehicle is not equipped with a computer, the display in the instrument cluster always shows the outside temperature.

Clock

If you wish to have a permanent time display, you can have it appear in the car radio display, refer to the Owner's Manual for Radio.

You can set the clock and the time display in the car radio as follows.

To set



Ignition key in position 1 or higher:

Hours

1. Keep button **2** pressed for several seconds until the hours are displayed and the colon flashes
2. Press button **1** repeatedly until the required hour is set

Minutes

3. Press button **2** to switch to the minutes display

4. Press button **1** repeatedly until the required minutes are set
5. Press button **2** to confirm the settings.

The set time of day is transferred to the car radio display or appears in the instrument cluster display.

Display mode

In ignition key position 0:
Press button **1**.

The time of day is displayed for several seconds.

Computer*

Mode selection

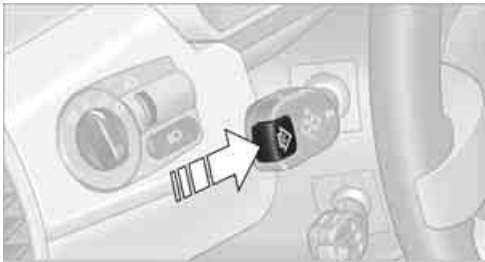

With the ignition key in position 1 or higher, you can use the onboard computer button BC in the turn signal lever to retrieve information from the computer for display in the instrument cluster.

Every time you tap the onboard computer button BC, another function is displayed.

The order of the displays:

- ▷ Time
- ▷ Outside temperature
- ▷ Average fuel consumption
- ▷ Cruising range
- ▷ Average speed.

With the ignition key in position 1 or higher, the last active setting is displayed.



If you wish, you can have all the displays of the following functions shown in another unit of measure. ◀

Outside temperature



To change the unit of measure, °F/°C

While the temperature display is active, keep the onboard computer button BC in the turn signal lever pressed until the display changes.

Ice warning

If the outside temperature drops to approx. 37.5 °F/3 °C, the computer automatically switches to the outside temperature display. A signal also sounds and the display flashes for a short time.

Clock



Setting the 12-hour or 24-hour mode*

If the vehicle is equipped with a computer, you can have the time displayed in either a 12-hour or 24-hour mode.

While the time display is active, press the onboard computer button BC in the turn signal lever until the display changes.

Average fuel consumption



If you press the onboard computer button BC in the turn signal lever for longer while the average fuel consumption is being displayed, a new consumption value is calculated from that point in time.

Any time spent when the vehicle is stationary and the engine shut off is ignored in the calculation.

Cruising range

The computer bases its calculations of the cruising range on the preceding driving style and on the remaining fuel in the tank.

 It is important that you refuel when the cruising range falls below approx. 30 miles/50 km. Otherwise, the engine cannot be guaranteed to operate properly and damage may result. ◀

Average speed

If you press the onboard computer button BC in the turn signal lever for longer while the average speed is being displayed, a new average speed value is calculated from that point in time.

Technology for safety and driving convenience

Driving stability control systems

Your BMW is equipped with a series of systems that help maintain driving stability even in adverse driving situations.

Antilock Brake System ABS

ABS keeps the wheels from locking during braking. Steering stability is maintained even during full brake applications. In this way, active safety is enhanced.

ABS is operational each time the engine is started. Braking safely, refer to page 69.

Electronic brake-force distribution

The system controls brake-force application at the rear wheels in order to obtain increased stability in the vehicle's braking response.

Dynamic Brake Control DBC

When the brake pedal is depressed quickly, this system automatically supplies maximum brake-servo boost, thereby helping to keep the vehicle's braking distance as short as possible during full brake applications. At the same time, the benefits of the ABS are also exploited.

As long as you are braking, do not reduce pressure on the brake pedal. When the brake pedal is released, the DBC is switched off.

Dynamic Stability Control DSC

DSC prevents slip at the drive wheels while starting off and accelerating the vehicle. DSC also recognizes unstable vehicle conditions, such as fishtailing or nose-diving. In these cases, and subject to physical limits, DSC helps to keep the vehicle on a steady course by reducing engine speed and by applying brakes at individual wheels.

 The laws of physics cannot be repealed even with DSC. It will always be the driver's responsibility to drive in a manner that matches road conditions. Therefore, do not limit the additional safety margin by practicing risky driving. ◀

Dynamic Traction Control DTC

DTC is a variant of the DSC in which forward momentum is optimized for special road conditions, e.g. snow-covered roads that have not yet been cleared. The system ensures maximum forward momentum, but driving stability is limited. Therefore, drive carefully in accordance with conditions.

In the following exceptional circumstances, it may be effective to activate the DTC for a short period:

- ▷ When driving on snow-covered grades, in slush or on uncleared, snow-covered roads
- ▷ When rocking the vehicle or starting off in deep snow or on loose surfaces
- ▷ When driving with snow chains.

Activating DTC



Press the button briefly; the DTC indicator lamp lights up in the instrument cluster.

Reactivating DTC

Press the button again; the DTC indicator lamp goes out in the instrument cluster.

Deactivating DTC and DSC at the same time



Press and hold the button for at least 3 seconds; the DSC indicator lamp lights up in the instrument cluster. No more interventions to increase stability and forward momentum are carried out.

To enhance vehicle stability, reactivate DSC as soon as possible.

Reactivating DSC

Press the button briefly; the indicator lamp goes out in the instrument cluster.

Checking



The indicator lamp flashes: DSC or DTC is regulating drive torque and braking forces.

The indicator lamp lights up: DTC and DSC have been deactivated together by pressing the DTC button.



The indicator lamp lights up: DTC has been activated by pressing the DTC button.



The DSC indicator lamp flashes and the DTC indicator lamp is lit: DTC is actively regulating drive torque and braking forces.



Malfunction in the driving stability control systems



The warning lamp for the brake system lights up in red, together with the yellow indicator lamps for ABS and DSC:



The driving stability control systems have failed.



Continue driving cautiously and defensively. Avoid hard brake applications. Have the system checked immediately.



Indication of the above-described malfunction in Canadian models.



The DSC warning lamp lights up together with the yellow warning lamp for the brake system:



DSC, including DTC and DBC, are malfunctioning.

The stabilizing interventions are no longer available. The vehicle remains operational. Have the system checked as soon as possible.



Indication of the above-described malfunction in Canadian models.



Brake force display

The Brake force display lights up in two stages depending on how strongly you are braking.

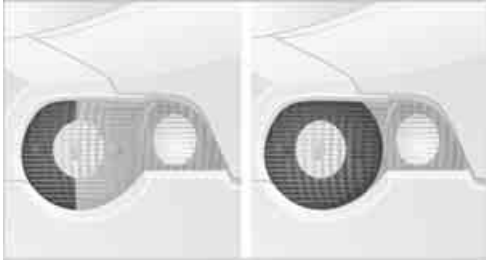

- ▷ Normal braking:
The brake lamps and the center brake lamp light up
- ▷ Hard braking or braking with ABS:
In addition, the illuminated surface of the brake lamps is extended, refer to the picture.

Flat Tire Monitor

The concept

As you drive, the Flat Tire Monitor keeps track of pressure levels in all four tires. The system alerts you whenever the inflation pressure of a tire falls significantly below the pressure of another tire.

In the event of tire pressure loss, the rolling radius of the tire changes, thereby affecting the rotational speed of the wheels. This change is detected, and a flat tire warning is issued to the driver.

System requirements

To ensure a reliable flat tire warning, the system must be initialized with the correct tire inflation pressures.

- ▷ Each time you correct the pressure in a tire, or change a wheel or tire, the system must be re-initialized. ◀

System limitations

⚠ The Flat Tire Monitor cannot provide you with advance warning of sudden and severe tire damage caused by external factors and does not detect the balanced and very gradual pressure loss that takes place in all four tires over an extended period of time. ◀

The system could issue a false warning or function in a delayed manner in the following situations:

- ▷ System was not initialized
- ▷ You are driving on a snow-covered or slippery road surface
- ▷ Performance-oriented driving: slip at the drive wheels, high levels of lateral acceleration
- ▷ You are driving with snow chains.

Initializing the system

▷ The initialization is completed while you are driving, and can be interrupted at any time. Initialization is automatically continued when you continue driving.

When driving with snow chains, do not initialize the system. ◀

1. Start the engine, but do not drive off



2. Press the button as long as you need to until the yellow indicator lamp in the instrument cluster lights up for a few seconds
3. Drive off.
Initialization is completed during the drive, without any feedback issued.

Flat tire warning



The warning lamp in the instrument cluster lights up in red. This visual alert is accompanied by an acoustic warning signal. There is a flat tire or a significant loss of tire pressure.

1. Carefully reduce your speed to under 50 mph / 80 km/h. Avoid strong braking and steering maneuvers. Do not exceed a maximum speed of 50 mph / 80 km/h.



Do not continue driving if the vehicle is not equipped with Run Flat tires, refer to page 82. If you continue to drive with a flat tire, a serious accident could result. ◀

2. Check the inflation pressure in all four tires as soon as possible.



If the inflation pressure is correct in all four tires, it is possible that the Flat Tire Monitor was not initialized. In this case, initialize the system. ◀

3. If there is a total loss of tire inflation pressure, 0 psi/0 kilopascal, or obvious tire damage, you can gauge the mileage for continued driving on the basis of the following indications:

- ▷ With a light load:
1 person without luggage:
approx. 155 miles/250 km
- ▷ With a medium load:
1 person, luggage compartment full,
or
2 persons with luggage:
approx. 90 miles/150 km
- ▷ With a full load:
2 persons, luggage compartment full:
approx. 30 miles/50 km.



Drive cautiously. Do not exceed a speed of 50 mph / 80 km/h. Driving characteristics change if there is a loss of tire pressure. This includes diminished track stability during braking, longer braking distances and modified steering. If unusual vibrations occur while driving, this can indicate a complete failure of the damaged tire. Reduce your speed and pull over

as soon as possible. Do not continue driving and contact a BMW center. ◀

Malfunction



The indicator lamp in the instrument cluster lights up yellow. The Flat Tire Monitor is malfunctioning or out of order. Have the system checked as soon as possible.

Airbags

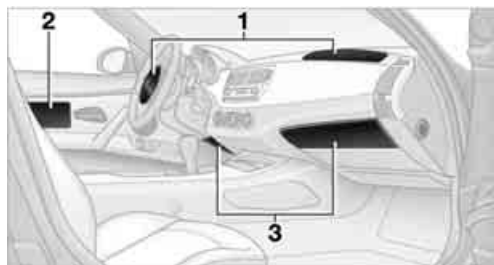

The following airbags are located under the marked covers:

- 1 Front airbags for driver and passenger
- 2 Side airbags for driver and passenger
- 3 Knee airbags for driver and passenger

Protective effect



Comply with the instructions on page 27, or the occupants' personal safety will be diminished. ◀

The front airbags help protect the driver and passenger in the event of a head-on collision where the protection provided by the safety belt alone would not be adequate. The side airbags help provide protection in the event of a collision from the side. Each of the side airbags is designed to help support the seat occupant's upper body. The knee airbags help provide additional protection in the event of a head-on collision.

The airbags are deliberately not triggered in every impact situation, e.g. not in less severe accidents, certain roll-over conditions, or rear-end collisions.

For information on the correct seating position, refer to page 27.

⚠ Do not apply adhesive materials to the cover panels of the airbags, cover them or modify them in any other way. Do not attempt to remove the airbag retention system from the vehicle. Never modify or tamper with either the wiring or the individual components in the airbag system. This category includes the upholstery in the center of the steering wheel, on the instrument panel, and the side trim panels on the doors. Do not attempt to remove or dismantle the steering wheel.

Do not touch the individual components directly after the system has been triggered, because there is a danger of burns.

If you note any indication of system malfunction, if you desire to have an airbag deactivated, or if the airbag retention system is triggered in response to an accident, you should always entrust all inspection, repair and dismantling operations to your BMW center.

Unprofessional attempts to service the system could lead to failure in an emergency or to undesired airbag activation, either of which could result in personal injury.

To ensure compliance with official safety regulations, please also entrust disposal of airbag generators to a BMW center. ◀

Airbag warning information is also provided on the sun visors.

Automatic deactivation of the passenger airbags

▶ Before transporting a child on the passenger seat be sure to observe the information/instructions under Transporting children safely, refer to page 33. ◀

Your BMW has a seat occupation detection system. By evaluating the weight on the passenger's seat, the system detects whether or not the seat is occupied by a child in the child-restraint system or an adult.

▶ When a child is seated in the child-restraint system or in an empty seat, the front, side and knee airbags are automatically deactivated on the passenger's side

▶ When an adult is traveling in the passenger's seat, the front, side and knee airbags remain active on the passenger's side.

⚠ Although not desired, it can occur in the case of heavier children that the passenger airbags remain active or, in the case of very light adults or young persons, that the passenger airbags are deactivated. The condition of the passenger airbag system will be shown by the indicator lamp in the central console, refer to Passenger airbag status lamp below. If the indicator lamp indicates that the passenger airbags are active and you want them to be deactivated, the airbags have to be deactivated with the vehicle ignition key and the key switch on the outer passenger's side of the instrument panel. Apart from passengers, do not place any additional objects on the passenger seat. Do not fit seat covers, seat cushion padding, ball mats or other items to the passenger seat unless they are specifically recommended by BMW. Do not place any items under the seat. Otherwise, the function of the seat occupation detection could be impaired. ◀

Operational readiness of the airbag system



The airbag indicator lamp in the instrument cluster indicates the operational readiness of the entire airbag system and the safety belt tensioners as of ignition key position 1.

The indicator lamp goes out after a few seconds.

Airbag system malfunction

▶ The indicator lamp does not light up as of ignition key position 1

▶ The warning lamp lights up continuously.

⚠ In the event of a malfunction, have the airbag system checked immediately. Otherwise, there is a risk that the system may not respond in the expected manner to an impact occurring within its normal response range. ◀

Passenger airbag status lamp



The center console contains one of the indicator lamps shown in the illustration.

The indicator lamp indicates whether or not the passenger airbag system is activated or deactivated as of ignition key position 1.

▶ The indicator lamp is used only for the passenger airbag system. The indicator lamp illuminates to show that the passenger airbag system is OFF/not active. ◀

- ▶ The lamp illuminates briefly during startup, but then goes out if the seat is empty, or if an adult or child of sufficient size is recognized
- ▶ The lamp remains illuminated when a child in a rear facing child-restraint system is detected, indicating that the passenger airbag system is off.

Find more information about the passenger airbag system and seat occupation detection in the section entitled Automatic deactivation of the passenger airbags.

Lamps

Parking lamps/Low beams



Parking lamps

 The front, rear and side vehicle lighting is switched on. You can use the parking lamps to signal the position of the vehicle when it is parked. For information on lighting on one side of the vehicle for parking, which is available as an additional feature, refer to page 57.

Low beams

 When you switch off the ignition with the low beam headlamps on, only the parking lamps will remain on.

Defective bulb

 The indicator lamp lights up: At least one bulb of the vehicle's exterior lighting has failed.

For replacing bulbs refer to page 91.

Follow me home lamps

When you activate the headlamp flasher after parking the vehicle and switching off the lights, the low beams will come on for a brief period.

 You can also have this function activated/deactivated if you wish. ◀

LIGHTS ON warning

Whenever you open the driver's door after having turned the ignition key to position 0, you will hear an acoustic signal for a few seconds to

remind you that the lamps have not been switched off.

Daytime driving lamps*

If you desire, the light switch can be left in the second position:

When the ignition is switched off, the external lighting is also switched off.



You can have the activation settings for the daytime driving lamps programmed on your vehicle. ◀

Automatic headlamp control*

 When the switch is set to this position, the system automatically activates and cancels the low beams in response to changes in ambient light, for example in tunnels, at dusk, and when it is raining or snowing.

 The low-beam headlamps remain on regardless of the ambient light when you switch on the fog lamps. ◀

 Automatic headlamp control cannot serve as a substitute for the driver's judgement in determining when the vehicle lights should be switched on. For example, the sensors are not able to detect fog. To avoid safety risks, you should respond to these kinds of low-visibility situations by switching the headlamps on manually. ◀



You can have the sensitivity of your vehicle's automatic headlamp control adjusted. ◀

High beams/Standing lamps

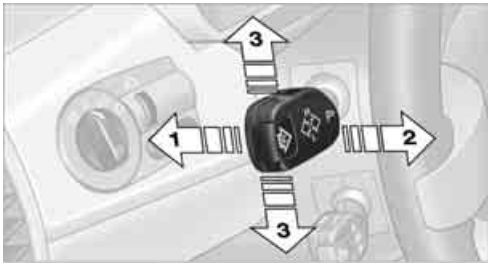

- 1 High beams
- 2 Headlamp flasher
- 3 Standing lamps

Left or right standing lamps*

As an additional feature, you can illuminate your vehicle on either side for parking:

1. Turn the ignition key to position 0 or remove it
2. Turn off the low beams
3. Push the lever in the appropriate turn-signal direction, until it engages.

 The standing lamps discharge the battery. Avoid using the standing lamps for longer periods of time; otherwise, you may no longer be able to start the engine. ◀

Fog lamps*



Tap the button to switch them on or off.

 The parking lamps or low-beam headlamps must be switched on. A green indicator lamp comes on in the instrument cluster to indicate that the front fog lamps are on.

 If the automatic headlamp control is on, the low beams will automatically come on whenever you activate the front fog lamps. ◀

Instrument lighting

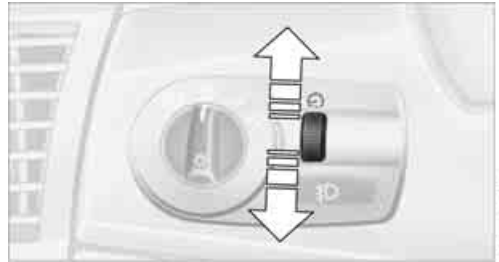

Turn the rotary dial to adjust the illumination intensity.

Interior lamps



The interior lamps operate automatically.

To switch the interior lamps on and off manually

Press button **1** briefly.

If you would like the interior lamps to remain off all the time, press and hold the button for approx. 3 seconds.

Press the button briefly to revert to normal operation.

Reading lamps*

Switch on and off with button **2** adjacent to each lamp.

Controlling the climate for pleasant driving

Air conditioning

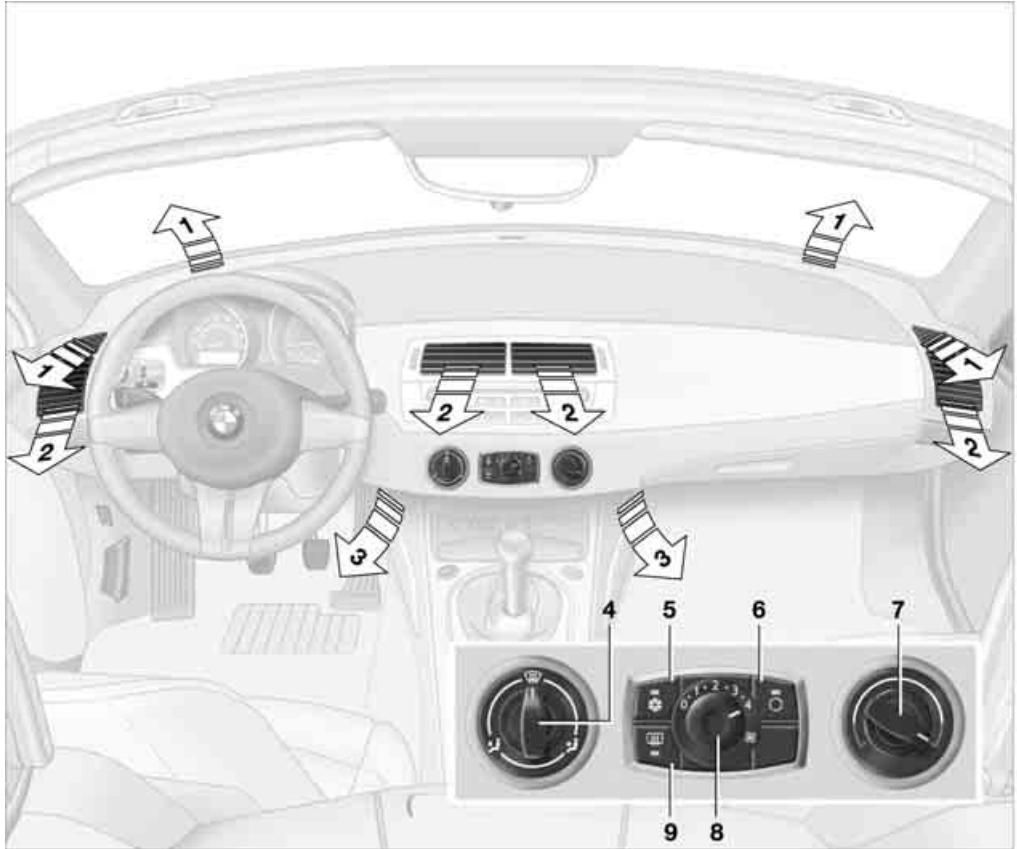



- 1 Air onto the windshield and the side windows
- 2 Air for the upper body area 59
- 3 Air for the footwell
- 4 Air distribution 59

- 5 Air conditioning 59
- 6 Outside air/recirculated air mode 59
- 7 Temperature adjustment 59
- 8 Air supply/blower 59
- 9 Rear window defroster 59

Air distribution



You can direct airflow onto the windows , toward the upper body  and into the footwell . All intermediate settings are possible.

Air supply/blower



Turn the rotary control to adjust the air supply. Both heating and ventilation become more effective as the air supply rate is increased.

Turn the rotary control toward zero: The blower and the heating are turned off, and the air supply is stopped.

Temperature



In order to increase the temperature of the passenger compartment, turn to the right toward the red zone.

Air conditioning



The air is cooled and dehumidified and, depending on the temperature setting, rewarmed.

Depending on the weather, the windshield may fog over briefly when the engine is started.

 Condensation forms during operation of the air conditioning system, which then exits under the vehicle. Traces of condensed water on the ground underneath the vehicle are thus normal. ◀

Outside air/recirculated air mode



If there are unpleasant odors in the outside air, you can temporarily block the supply of incoming air. The system then recirculates the air currently within the vehicle.

 If the windows fog over in the recirculated air mode, switch this mode off and increase the air supply as required. Do not use the recirculated-air mode continuously over a long period of time as this would otherwise reduce the air quality in the interior of the vehicle. ◀

Rear window defroster



The indicator lamp lights up when the rear window defroster is active. The rear window defroster switches off automatically.

Ventilation

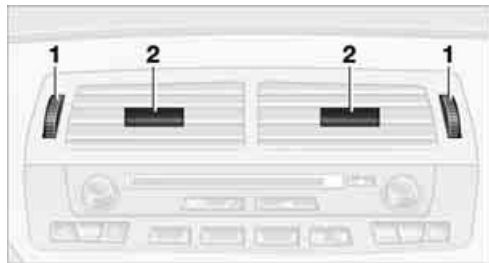

You can adjust the blower controls for the upper body area to obtain the optimum airflow rates and directions for your personal requirements:

- 1 Rotary dials for opening and closing the vents at any setting desired
- 2 Slide for adjusting airflow direction

Microfilter

The built-in microfilter removes dust and pollen from the incoming air and in the recirculated air mode. Your BMW center will replace this filter during the regularly scheduled maintenance. A substantial reduction in airflow indicates that the filter needs to be replaced earlier.

To defrost windows and remove condensation



- 1 Turn the rotary control to 
- 2 Turn the rotary blower control for the air supply completely to the right
- 3 Turn the rotary temperature control completely to the right
- 4 To defrost the rear window, switch on the rear window defroster

Automatic climate control*

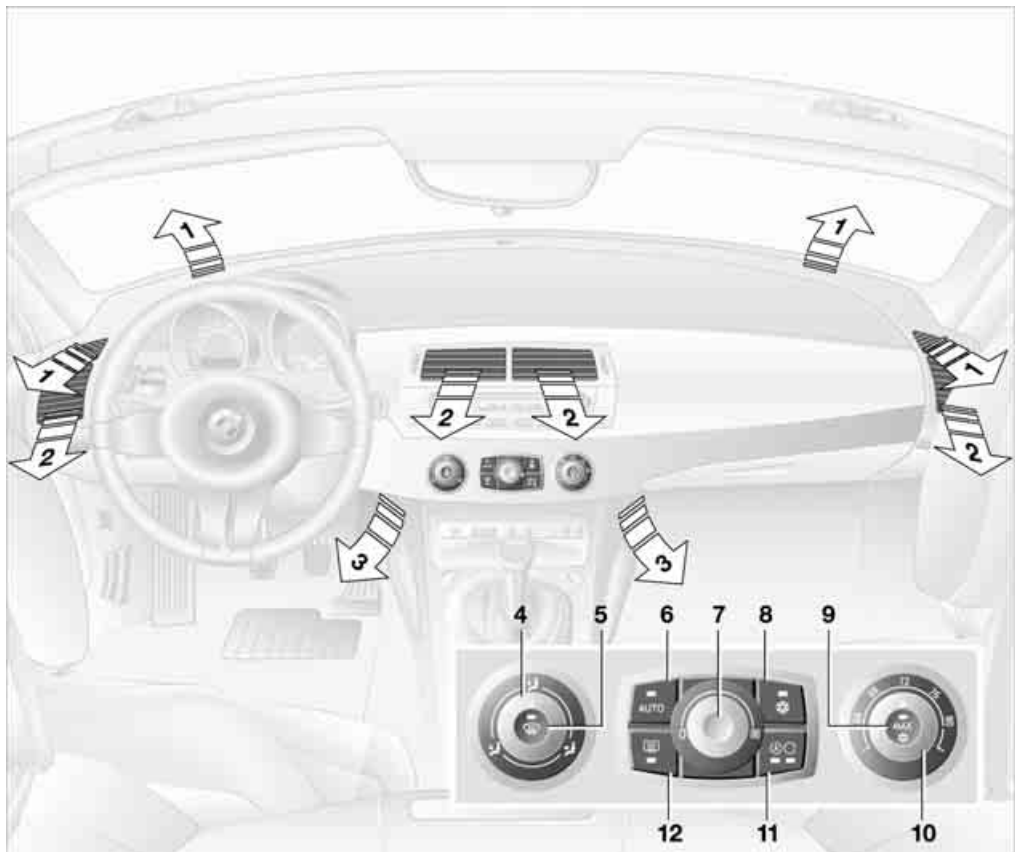

- 1 Air onto the windshield and the side windows
- 2 Air for the upper body area [63](#)
- 3 Air for the footwell
- 4 Individual air distribution [62](#)
- 5 To defrost windows and remove condensation [62](#)
- 6 Automatic air distribution and air supply [62](#)
- 7 Air supply/blower [62](#)
- 8 Air conditioning [62](#)
- 9 Maximum cooling [62](#)
- 10 Temperature [62](#)
- 11 Outside air/Automatic recirculated air control AUC/recirculated air mode [62](#)
- 12 Rear window defroster [63](#)

Tips for pleasant driving

Use the automatic system – switch on with AUTO button **6**. Select the desired interior temperature.

Detailed setting options are described for you below.

Automatic air distribution and supply





The AUTO program assumes the adjustment of the air distribution and air supply for you and in addition adapts the temperature to external influences, summer or winter, to meet preferences you can specify.

In the AUTO program, the air conditioning mode is also turned on at the same time.

 The AUTO program functions only to a limited extent when the convertible top is open. ◀

Individual air distribution



You yourself can direct airflow onto the windows , toward the upper body  and into the footwell . The arrow lights up. The automatic air supply remains unchanged. All intermediate settings are possible. By pressing the AUTO button, you can reactivate the air distribution.

Temperature



The interior temperature that appears on the display panel is a general figure intended for reference purposes. When you start the vehicle, the system ensures that the selected temperature is reached as quickly as possible, regardless of the season. It then maintains this temperature.

Air supply/blower



Turn the rotary control to adjust the air supply. This shuts off the automatic air supply. The arrow lights up. The automatic air distribution remains unchanged. You can reactivate the automatic air supply by pressing the AUTO button.

When you turn the rotary control toward zero: the blower, heating and air conditioner are switched off, and the air supply is stopped. You can reactivate the system by turning the control toward the right again.

To defrost windows and remove condensation



This program quickly removes ice and condensation from the windshield and the side windows.

Maximum cooling



Above an outside temperature of 32 °F / 0 °C and with the engine running, you achieve a maximum cooling effect as quickly as possible. At the same time, the air conditioning is turned on.

The temperature is set to the lowest possible value. The system switches to the recirculated air mode, and air flows at maximum blower speed from the ventilation grills in the upper body area only. Therefore, the air outlets must always be open when you select this program.

Air conditioning



The air is cooled and dehumidified and, depending on the temperature setting, rewarmed.

Depending on the weather, the windshield may fog over briefly when the engine is started.

The air conditioning system is automatically switched on when you use the AUTO program.

 Condensation forms during operation of the air conditioning system, which then exits under the vehicle. Traces of condensed water on the ground underneath the vehicle are thus normal. ◀

Outside air/Automatic recirculated air control AUC/recirculated air mode



You can respond to unpleasant external odors or pollutants by temporarily stopping the flow of outside air. The system then recirculates the air currently within the vehicle.

By repeatedly pressing the button, you can select one of three different operating modes.

- ▷ Indicator lamps off: outside air flows into the vehicle
- ▷ Left-hand indicator lamp on, AUC mode: the system detects pollutants in the outside air and responds by deactivating the outside airflow as required. The system then recirculates the air currently within the vehicle. Depending on air quality requirements, the system automatically switches between outside air supply and recirculation of the air already within the vehicle
- ▷ Right-hand indicator lamp on: the flow of outside air is permanently blocked. The system recirculates the air already within the vehicle.

 If the windows fog over in the recirculated air mode, switch this mode off and increase the air supply as required. Do not use the recirculated-air mode continuously over a long period of time as this would otherwise reduce the air quality in the interior of the vehicle. ◀

Rear window defroster



The indicator lamp lights up when the rear window defroster is active. The rear window defroster switches off automatically.

Ventilation

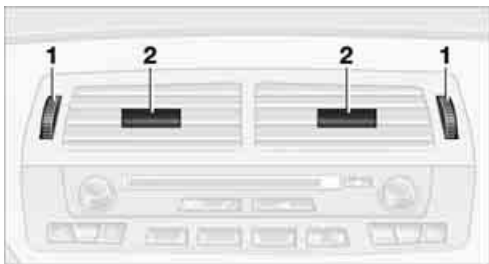

You can adjust the blower controls for the upper body area to obtain the optimum airflow rates and directions for your personal requirements:

- 1 Rotary dials for opening and closing the vents at any setting desired
- 2 Slide for adjusting airflow direction

Microfilter/activated-charcoal filter

The built-in microfilter removes dust and pollen from the incoming air. The activated-charcoal filter provides additional protection by filtering gaseous pollutants from the outside air. Your BMW center replaces this combined filter as a standard part of your scheduled maintenance. A substantial reduction in airflow indicates that the filter needs to be replaced earlier.

Interior conveniences

Glove compartment

To open

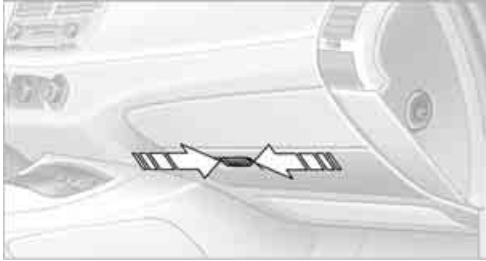

Press the two push buttons together.

To close

Swing the door up.

 To prevent injury in the event of an accident, close the glove compartment immediately after use. ◀

Storage compartments

Storage compartment between backrests

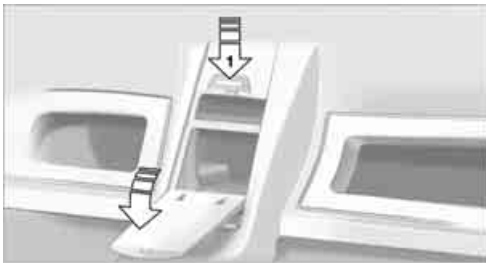

To open

1. Press button; see arrow 1
2. Swing the cover downward.

To close

Swing the door up.

Locking/unlocking

The storage compartment between the backrests is automatically locked and unlocked with the central locking system.

Releasing manually

In the event of an electrical malfunction of the central locking system, you can manually unlock the storage compartment between the seats.

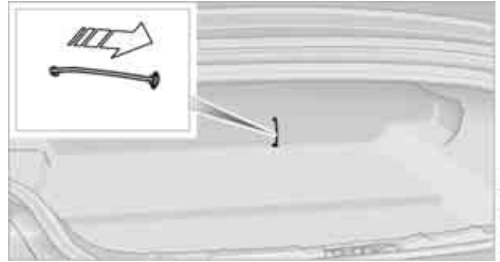

1. Pull on the cord in the rear luggage compartment panel.
The storage compartment between the seats unlocks
2. Press button; see arrow 1.

Other compartments and nets*

You will find additional storage compartments in the front doors and in the center console.

Depending on the particular version, the vehicle may also be equipped with two storage compartments behind the seats.

A net* is located on the passenger side along the center console.

Beverage holder

A beverage holder is located on either side beneath the air outlets.

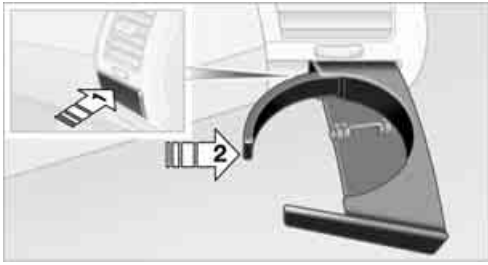

1. Press the trim piece beneath the air outlets; see arrow 1
2. Place the beverage into the holder
3. Adjust the holder to fit the size of the beverage container; see arrow 2.

⚠ Do not place glass containers into the beverage holders, as this increases the risk of injury in the event of an accident. ◀

Preparations for the cellular phone*

Hands-free system



In vehicles with a telephone preparation, the cover for the hands-free microphone is located on the trim of the steering column.

For further information on the cellular phone, refer to the Owner's Manual for the telephone.

Ashtray*

To empty



1. Open cover
2. Pull out ashtray 1.

Cigarette lighter

Press in lighter 2. As soon as the lighter springs back out, it can be removed.

⚠ Hold or touch the hot cigarette lighter by the knob only. Holding or touching it in other areas could result in burns.

The cigarette lighter remains operational even when the ignition key has been removed. For this reason, children should never be left in the vehicle unattended. ◀

Power socket

The cigarette lighter socket can be used as a power socket for a flashlight, car vacuum cleaner, etc. up to a rating of approx. 200 watts at 12 volts.

Do not damage the socket by inserting plugs of a different shape or size.



Driving tips

Driving tips provides you with information you will need in certain driving situations and when using special operating modes.

Special operating instructions

Break-in procedures

Moving parts need to be given some time until they can interact smoothly with one another. To ensure that your vehicle provides maximum economy throughout a long service life, we request that you observe the following:

Engine and differential

Up to 1,200 miles/2,000 km:

Drive at varying engine and road speeds, but do not exceed the following engine or road speed:

4,500 rpm / 4,500/min or 100 mph / 160 km/h.

Obey your local and state maximum speed limits.

Refrain from using full throttle and avoid pressing the accelerator beyond the kickdown point.

After you have driven 1,200 miles/2,000 km, you can gradually increase the engine or road speeds.

Sequential manual gearbox SMG

Up to 1,200 miles/2,000 km:

Do not use the acceleration assistant during the break-in period.

Tires

Due to technical factors associated with their manufacture, tires do not achieve their full traction potential until an initial break-in period has elapsed. You should therefore drive with extra caution during the first 200 miles/300 km.

Obey your local and state maximum speed limits.

 When the vehicle is operated on wet or slushy roads, a wedge of water may form between the tire and the road surface. This phenomenon is referred to as hydroplaning and can lead to partial or complete loss of traction, vehicle control and braking effectiveness. Reduce your speed on wet roads. ◀

Brake system

Approx. 300 miles/500 km must elapse before the brake pads and rotors achieve their optimal surface and wear pattern.

To break in the separate parking brake drums, apply the parking brake lightly when coasting to a standstill – at a traffic signal, for instance; use caution to avoid posing a danger to other road users.

To avoid corrosion, repeat this procedure from time to time.

The brake lamps do not come on when the parking brake is set.

 Vacuum for the brake system servo unit on your BMW is available only when the engine is running. When you move the car with the engine off, e.g. by towing, substantially higher levels of pedal force will be required to brake the vehicle. ◀

Clutch

The clutch will achieve its optimal functionality after approx. 300 miles/500 km. Shift gears carefully during the break-in period.

After replacing components

Follow the same break-in procedure again if any of the components mentioned above have to be replaced in the future.

Driving notes

Close the luggage compartment lid

 Operate the vehicle only when the luggage compartment lid is completely closed, otherwise exhaust fumes could penetrate into the interior of the vehicle. ◀

Should it be absolutely necessary to operate the vehicle with the luggage compartment lid open and with the convertible top closed:

1. Close all windows
2. Increase the air supply from the air conditioner or automatic climate control to a high level. Refer to page 58 or 61.

Hot exhaust system

 High temperatures occur with every vehicle equipped with a catalytic converter. Heat shields are installed adjacent to some sections of the exhaust system. Never remove these shields; do not apply undercoating to their surfaces. When driving, standing at idle and parking the vehicle, take care to avoid contact between the hot exhaust system and flammable materials, e.g. hay, leaves, grass, etc. Such contact could lead to a fire, resulting in serious personal injury and property damage. ◀

Hydroplaning

 When driving on wet or slushy roads, reduce vehicle speed. If you do not, a wedge of water may form between the tires and the road surface. This phenomenon can lead to partial or complete loss of traction, vehicle control and braking effectiveness. ◀

Driving through water

 Do not drive through water on the road if it is deeper than 1 ft/30 cm, and then only at walking speed. Otherwise, the vehicle's engine, the electrical systems and the transmission may be damaged. ◀

Use the parking brake on inclines

 On inclines, keep the vehicle from rolling by using the parking brake rather than by slipping the clutch, which would lead to a high degree of clutch wear. ◀

Braking safely

Your BMW is equipped with ABS as a standard feature. If you are in a situation which requires full braking, it is best to brake using maximum brake pressure: panic stop. Since the vehicle maintains steering responsiveness, you can still avoid possible obstacles with a minimum of steering effort.

Pulsation at the brake pedal combines with sounds from the hydraulic circuits to indicate to the driver that ABS is in its active mode.

Wet roads

If the roads are wet or if there is heavy rain, it is advisable to gently press the brakes for a brief moment every few miles/kilometers. Watch traffic conditions to ensure that this maneuver does not endanger other road users. The resulting heat dries the brake rotors and brake pads. Immediate braking force is then available if necessary.

Inclines

 To prevent overheating and, as a result, diminished braking effectiveness, drive down long or steep downhill grades in a gear which requires the least braking. Otherwise, even light but consistent pedal pressure can lead to high temperatures, brake wear and possibly even brake failure. ◀

The braking power of the engine can be further enhanced by downshifting the automatic transmission in manual mode, if necessary, into first gear; refer to pages 39 and 41. This prevents an excessive load on the brakes.

 Do not coast with the clutch depressed or with the transmission or selector lever in Neutral. Do not coast with the engine switched off. Otherwise, the engine provides no braking effect while the transmission is in idling position, and there is no power-assist for braking or steering when the engine is off. Floor mats, floor carpets or other objects must not be in the area near the brake or accelerator pedal, as this could impair the movement of the pedals. ◀

Corrosion on the brake rotors

Limited vehicle use, extended periods with the vehicle parked or in storage, and operating conditions in which braking is restricted to gentle, low-pressure applications will all increase the tendency for corrosion to form on the rotors and contamination to accumulate on the brake pads. This occurs because the minimal pres-

sure which must be exerted by the pads to clean the rotors by brake applications is not reached.

If the brake rotors are corroded, they will tend to respond to braking with a pulsating effect which even extended application will fail to cure.

Interior and exterior mirrors with automatic dimming feature*

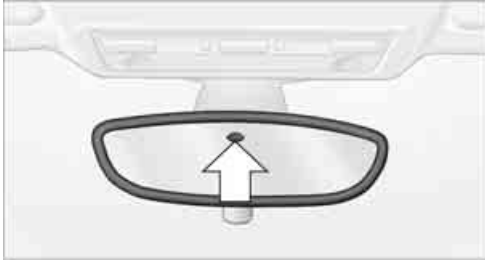

Two photocells in the interior rearview mirror serve to control the interior and exterior mirrors with automatic dimming feature. One photocell is positioned in the mirror's lens, see arrow, while the other is on the opposite side of the mirror.

To ensure perfect functioning, keep the photocells clean and the area between the interior rearview mirror and the windshield free of any obstruction like stickers, etc.

When the vehicle is parked

Condensation formed in the air conditioning system during operation exits under the vehicle. Traces of condensed water on the ground underneath the vehicle are thus normal.

Mobile equipment in the vehicle

 BMW advises against using mobile equipment, e.g. cellular phones, inside the vehicle without connecting them directly to an outside antenna. Otherwise, it cannot be ruled out that vehicle electronics and the mobile equipment interfere with one another. In addition, it is not ensured that the radio waves emitted during transmission are directed outside of the vehicle interior. ◀

Cargo loading

 Avoid overloading the vehicle so that the permissible carrying capacity of the tires is not exceeded. Otherwise, overheating and inner damage to the tires may result. The ultimate result can assume the form of a sudden air loss. ◀

Determining the maximum load



1. Locate the following statement on your vehicle's placard*:

 The combined weight of occupants and cargo should never exceed XXX kg or YYY lbs; otherwise damage to the vehicle and unstable driving conditions could result. ◀

2. Determine the combined weight of the driver and passenger that will be riding in your vehicle
3. Subtract the combined weight of the driver and passenger from XXX kilograms or YYY pounds
4. The resulting figure equals the available amount of cargo and luggage load capacity. For example, if the YYY amount equals 551 lbs. and there will be two 150 lbs. passengers in your vehicle, the amount of available cargo and luggage load capacity is 251 lbs.
551 lbs. minus 300 lbs. = 251 lbs.
5. Determine the combined weight of luggage and cargo being loaded on the vehicle. That weight may not safely exceed the available cargo and luggage load capacity calculated in Step 4.

Load

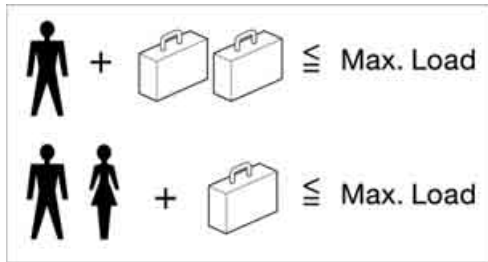

The permissible load is the sum of the occupants' weights and the weight of the cargo. The greater the weight of the occupants, the less cargo can be transported.

Stowing cargo



- ▶ Load heavy cargo as far forward as possible, directly behind the luggage compartment partition, and as low as possible
- ▶ Cover sharp edges and corners.

! To avoid damaging the rear of the backrest or the rear interior trim panel, do not stow heavy cargo or cargo with sharp edges and corners behind the seats.

In addition, large and bulky cargo stowed behind the seats may prevent the backrest from engaging properly. Therefore, ensure that the backrest is securely locked and if necessary, move the seat forward, refer to page 28.

Always position and secure the load as described above; otherwise, it can endanger the passengers, for example during braking or evasive maneuvers.

Do not exceed the approved gross vehicle weight or the specified maximum axle loads. Refer to page 103. Otherwise the vehicle's operating safety is no longer assured and you

are in violation of the law.

Do not stow heavy or hard objects in the passenger compartment without first securing them. Otherwise they would be thrown around during braking and evasive maneuvers and would endanger the occupants. ◀

Convertible top compartment

 With the convertible top closed, you can enlarge the luggage compartment, refer to page 19.

It is advisable to always fold down the convertible top compartment panel as soon as you have removed your cargo from the luggage compartment. This way, you can be sure that you can always operate the convertible top at any time. Conversely, when the convertible top is closed, raise the convertible top compartment panel before stowing your cargo in the luggage compartment to avoid any damage to the convertible top compartment or your load.

Do not stow any items on the convertible top compartment panel since the convertible top could be damaged while it is opening. ◀

If you stow cargo behind the seats of your BMW:

- ▶ Only stow light objects such as clothing, etc.
- ▶ Do not pile objects higher than the top edge of the backrests.

Hardtop preparation*

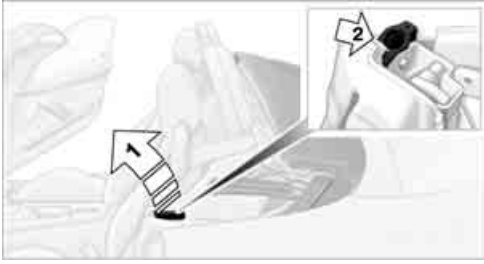

Pull covers off, see arrow **1**.

The brackets for attaching the hardtop are located underneath the covers; see arrow **2**.

 For instructions on how to install the hardtop, please read the accompanying assembly information.

The hardtop is available from your BMW center as a special option. ◀





Mobility

To ensure that you stay mobile, the following chapter provides you with important information on fuels and fluids, tires and wheels, maintenance procedures and steps to take in the event of a breakdown.

Refueling

Fuel filler door



1. Open fuel filler door
2. Turn the gas cap in a counter-clockwise direction
3. Place the cap in the bracket on the filler door.

Releasing manually

If an electrical malfunction occurs, you can unlock the fuel filler door manually:

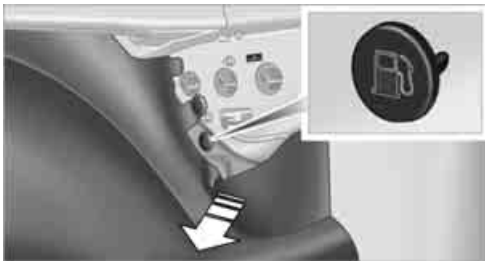

1. Remove the covers of the tail lamps by turning the lock to the right; refer also to page 93
2. Pull the luggage compartment trim panel slightly toward the interior.
The green button with the fuel pump symbol becomes visible
3. Undo the adhesive strip and pull off
4. Pull the button
The fuel filler door is released.

 Pull on the button slowly and carefully as it could otherwise be torn off. ◀

Note when refueling

 When handling fuels, comply with all of the applicable safety precautions posted at the service station. ◀

When refueling, insert the filler nozzle completely into the filler pipe. Lifting the nozzle during refueling

- ▷ results in premature shutoff
- ▷ and will reduce the effect of the vapor recovery system on the pump.

The fuel tank is full when the filler nozzle shuts off the first time.

Closing the fuel filler cap

Place the cap in position and turn it clockwise until a clearly audible click is heard.

 Close the filler cap carefully after refueling until a click is heard. While closing, be sure not to squeeze the strap which is fastened to the cap. A loose or missing cap will activate the Check gas cap lamp*. ◀

 Warning lamp* lights up.
The gas cap is not properly closed or is missing. Check if the gas cap is properly closed.

Contents of the fuel tank

Approx. 14.5 gallons/55 liters, of which approx. 2.1 gallons/8 liters are reserve capacity.

 Fill the fuel tank before it is completely empty. Driving to the last drop of fuel can prevent the engine from operating properly and result in damage. ◀

Fuel specifications

The engine uses lead-free gasoline only.

Required fuel

Premium Unleaded Gasoline, Minimum Octane Rating: 91.

Minimum Octane Rating corresponds to the Anti Knock Index AKI and is determined by the so-called (R+M)/2 method.

 Do not use leaded gasoline, as otherwise the lambda probe and catalytic converter will be permanently damaged. ◀

Use high-quality brands

Field experience has indicated significant differences in fuel quality: volatility, composition, additives, etc., among gasolines offered for sale in the United States and Canada. Fuels containing up to and including 10% ethanol or other oxygenates with up to 2.8% oxygen by weight, that is, 15% MTBE or 3% methanol plus an equivalent amount of co-solvent, will not void the applicable warranties with respect to defects in materials or workmanship.

 The use of poor-quality fuels may result in drivability, starting and stalling problems especially under certain environmental conditions such as high ambient temperature and high altitude.

Should you encounter drivability problems which you suspect could be related to the fuel you are using, we recommend that you respond by switching to a recognized high-quality brand.

Failure to comply with these recommendations may also result in unscheduled maintenance. ◀

Wheels and tires

Tire inflation pressure

Information for your safety

It is not merely the tire's service life, but also driving safety and driving comfort that largely depend on the condition of the tires and the maintenance of the specified tire pressure.

Checking tire pressures

Check the tire inflation pressures only when the tires are cold. This means after a maximum driving distance of 1.25 miles/2 km or if the vehicle has been parked for at least 2 hours. Warm tires have higher inflation pressures.

 Check tire inflation pressures regularly and correct them if necessary: at least every two weeks and before every extended journey. Otherwise, incorrect tire pressures can cause driving instability or tire damage, ultimately resulting in accidents. ◀

 Reinitialize the Flat Tire Monitor after correcting the tire inflation pressure. Refer to page 52. ◀

 To determine the correct tire inflation pressure for your tires, observe the pressures listed for the relevant tire sizes. ◀

Tire size

The inflation pressures in the table apply to BMW-approved tire sizes and recommended tire brands. Your BMW center will be glad to supply this information.

Inflation pressures for original tires



The specified inflation pressures for tires at ambient temperature are provided on the placard on the B-pillar and are visible when the driver's door is open.

Inflation pressures for other tire sizes

The following tire inflation pressure tables show the inflation pressures for the specified tire sizes at ambient temperature.

Z4 2.5i

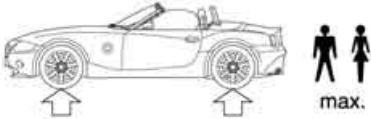
Tire size	Pressure specifications in psi/kPa	
All pressure specifications in the table are indicated in psi/kilopascal with cold tires, cold = ambient temperature		
		
225/50 R 16 92 V	30/210	33/230
225/45 R 17 91 W		
225/40 R 18 88 W	30/210	–
255/35 R 18 90 W	–	33/230
205/55 R 16 91 Q/T/H M+S		
225/50 R 16 92 Q/T/H M+S	30/210	33/230
225/45 R 17 91 Q/T/H M+S		

You will find more information about permissible loads and weights on page [103](#).

Z4 3.0i

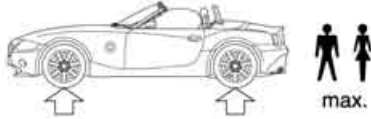
Tire size	Pressure specifications in psi/kPa	
All pressure specifications in the table are indicated in psi/kilopascal with cold tires, cold = ambient temperature		
		
225/45 R 17 91 W	33/230	36/250
225/40 R 18 88 W	33/230	–
255/35 R 18 90 W	–	36/250
225/50 R 16 92 Q/T/H M+S	33/230	36/250
225/45 R 17 91 Q/T/H M+S		

You will find more information about permissible loads and weights on page [103](#).

Tire coding

Understanding the lettering on the tire sidewall makes it easier to identify and choose the correct tires.

Tire size

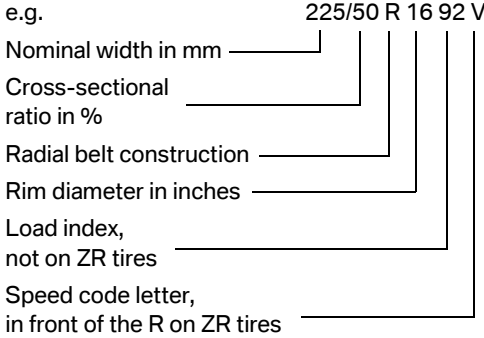

Speed code letter

- Q= up to 105 mph / 160 km/h
- T= up to 118 mph / 190 km/h
- H= up to 131 mph / 210 km/h
- V= up to 150 mph / 240 km/h
- W= up to 167 mph / 270 km/h
- Y= up to 186 mph / 300 km/h

Tire Identification Number

Tires with DOT codes meet the guidelines of the U.S. Department of Transportation.

DOT code:

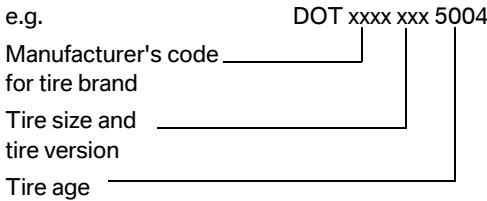

Tire age

The date on which the tire was manufactured is indicated by the code on the sidewall: DOT ... 5004 indicates that the tire was manufactured in week 50 of the year 2004.

BMW recommends the replacement of all tires every 6 years at the latest, even if a tire usage of 10 years is possible.

Uniform Tire Quality Grading

Quality grades can be found where applicable on the tire sidewall between tread shoulder and maximum section width. For example:

Treadwear 200 Traction AA
Temperature A

DOT quality grades

Tread wear
Traction AA A B C
Temperature A B C



All passenger car tires must conform to Federal Safety Requirements in addition to these grades. ◀

Tread wear

The tread wear grade is a comparative rating based on the wear rate of the tire when tested under controlled conditions on a specified government test course.

For example, a tire graded 150 would wear one and one-half, 1 ½, times as well on the government course as a tire graded 100. The relative performance of tires depends upon the actual conditions of their use, however, and may depart significantly from the norm due to variations in driving habits, service practices and differences in road characteristics and climate.

Traction

The traction grades, from highest to lowest, are AA, A, B and C.

Those grades represent the tire's ability to stop on wet pavement as measured under controlled conditions on specified government test surfaces of asphalt and concrete. A tire marked C may have poor traction performance.



The traction grade assigned to this tire is based on straight-ahead braking traction tests, and does not include acceleration, cornering, hydroplaning, or peak traction characteristics. ◀

Temperature

The temperature grades are A, the highest, B and C, representing the tire's resistance to the generation of heat and its ability to dissipate heat when tested under controlled conditions on a specified indoor laboratory test wheel. Sustained high temperature can cause the material of the tire to degenerate and reduce tire life, and excessive temperature can lead to sudden tire failure. The grade C corresponds to a level of performance which all passenger car tires must meet under the Federal Motor Vehicle Safety Standard No. 109. Grades B and A represent higher levels of performance on the laboratory test wheel than the minimum required by law.

 The temperature grade for this tire is established for a tire that is properly inflated and not overloaded. Excessive speed, under-inflation, or excessive loading, either separately or in combination, can cause heat buildup and possible tire failure. ◀

RSC: Run Flat tires

Run Flat tires are labeled on the sidewall with a circular symbol containing the letters RSC. Refer to page 82.

M+S

Winter and all-season tires. These have better winter performance properties than summer tires.

Tire condition

Inspect your tires frequently for tread wear, signs of damage and for foreign objects lodged in the tread. Check the tread depth.

Tire tread

Tread depth should not be allowed to go below 1/8 in / 3 mm even though in Europe, for example, the legally specified minimum tread depth is only 1/16 in / 1.6 mm. Below 1/8 in / 3 mm tread depth, there is a very high risk of hydroplaning, even with only small amounts of water on the road and at relatively moderate speeds.

At tread depths below approx. 1/6 in / 4 mm, winter tires display a perceptible decrease in their ability to cope with winter driving conditions, and should be replaced in the interest of safety.

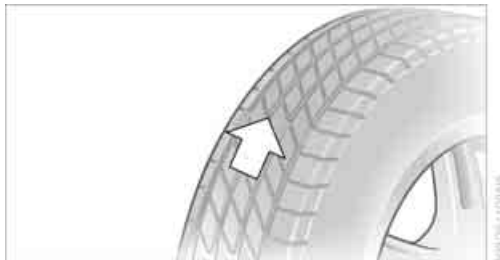

Tread wear indicators in the tread-groove base, see arrow, are distributed around the wheel circumference and are labeled on the tire sidewall as TWI, Tread Wear Indicator. At a tread depth of 1/16 in / 1.6 mm, the indicators signal that the legally permissible wear limit has been reached.

Wheel/tire damage

 Due to low-profile tires, please note that wheels, tires and suspension parts are more susceptible to road hazards and consequential damages. ◀

Unusual vibrations encountered during normal vehicle operation can indicate tire failure or some other vehicle malfunction. This type of problem can be caused by contact with curbs, etc. This is also true for irregularities in the vehicle's handling characteristics, such as a pronounced tendency to pull to the left or right.

 Should this occur, respond by immediately reducing your speed. Proceed carefully to the nearest BMW center or professional tire center, or have the vehicle towed there. Tire damage up to and including sudden and complete air loss can pose an extreme hazard for both vehicle occupants and other road users. ◀

Run Flat tires fitted



Run Flat tires are labeled on the sidewall with a circular symbol containing the letters RSC.

Run Flat tires consist of self-supporting tires and special rims. The tire reinforcement ensures that driving remains possible to a restricted degree in the event of pressure drop or even if the tire is deflated.

Wheel and tire replacement

 Have new wheels and tires mounted only by a BMW center or specialized tire shop that works according to BMW requirements with the appropriately trained personnel. Work that is improperly carried out could result in consequential damage and pose safety hazards. Make sure that the new wheels are balanced. ◀

 BMW advises against using retreaded tires, since driving safety may be impaired. This is due to possible variations in casing structures and, in some cases, to their extreme age, factors which can lead to a decrease in their durability. ◀

The correct wheels and tires

 BMW recommends using only wheels and tires that have been approved by BMW for your particular vehicle model, as otherwise body contact and serious accidents can result despite the use of the same nominal size, e.g. due to manufacturing tolerances. If non-approved wheels and tires are used, BMW cannot evaluate their suitability, and therefore cannot be held liable for driving safety. ◀

Your BMW center can provide you with information about the correct wheel and tire combinations for your vehicle.

The correct wheel and tire combination also affects other systems which would otherwise be impaired, for example ABS or DSC.

To maintain good handling and vehicle response, use only tires of a single brand and tread configuration. In the event of a flat tire, remount the previous wheel and tire combination as soon as possible.

Recommended tire brands

BMW tests certain tire brands for each tire size, classifies them as road-safe and approves them. You can best find out about these at a specialized shop, particularly your BMW center. Observe any country-specific regulations, e.g. on making a corresponding entry in the vehicle documents.

The factory-approved radial-ply tires are matched to your vehicle and have been selected to provide optimum safety and driving comfort when used properly.

Run Flat tires

When mounting new tires or replacing summer tires with winter tires, or vice versa, use Run Flat tires since no spare wheel is available in the event of a flat. Your BMW center will be glad to provide you with more information.

 For safety reasons, BMW recommends to have Run Flat tires replaced, not repaired, if they are damaged. ◀

Special characteristics of winter tires

BMW recommends the use of winter tires for operation under winter road conditions. While all-season tires with M+S designation provide better winter traction than summer tires, they generally do not achieve the full performance of winter tires.

Observing speed ratings

 Never exceed the maximum speed for which the winter tires are rated. Unprofessional attempts by laymen to service tires

can lead to damage and accidents. Have this work performed by skilled professionals only. The technicians at your BMW center will be glad to assist you with the required professional knowledge and specialized equipment. ◀

Storage

Store tires in a cool, dry place, protecting them against light whenever possible. Protect the tires from contact with oil, grease and fuel. Do not exceed the maximum tire inflation pressures specified on the tire sidewall.

Snow chains*

Only certain types of snow chains have been tested by BMW, classified as road-safe and approved. Consult your BMW center for more information. BMW recommends using only approved fine-link snow chains. Use them in pairs on either summer or winter tires, but only on both rear wheels.

Comply with all manufacturer's safety precautions when mounting the chains.

Do not exceed a speed of 30 mph / 50 km/h when using snow chains.



Do not initialize the Flat Tire Monitor after snow chains have been mounted.

When driving with snow chains, it may be useful to deactivate the DSC briefly. Refer to page 51. ◀

In the engine compartment

⚠ Do not attempt to service your vehicle if you do not have the required technical background. If you are not familiar with the regulations to be observed, have your vehicle serviced only by a BMW center or a workshop that works according to BMW requirements with the appropriately trained personnel. Work that is improperly carried out could result in consequential damage and pose safety hazards. ◀

Hood

To release



Pull the lever located under the left-hand side of the instrument panel.

To open

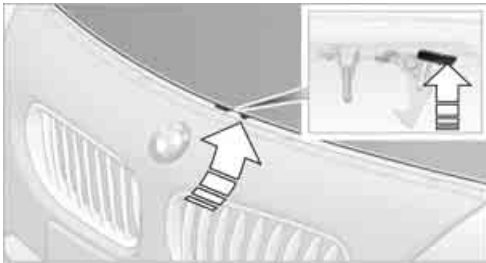

1. Reach under the engine hood
2. Push the release handle up
3. Open the hood.

To close

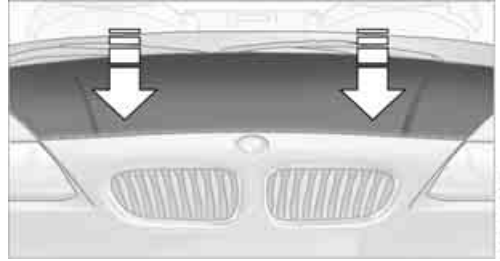

Allow the hood to fall from a low height and push on both sides so that it audibly engages.

⚠ As in all closing procedures, avoid injuries by making sure that the travel path of the hood is clear when it is closed. If you notice while driving that the hood is not completely closed, stop immediately and close it securely. ◀

Engine compartment

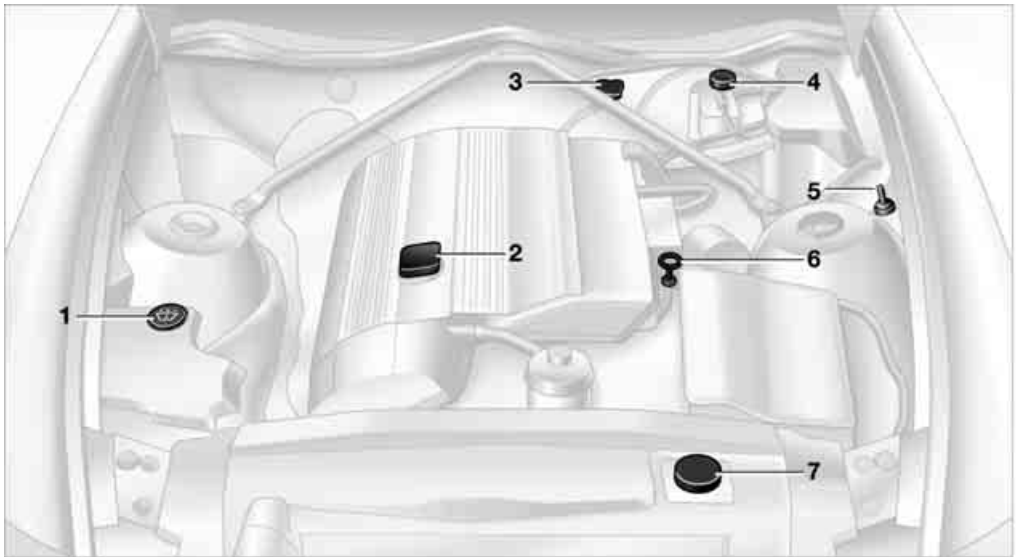

- | | |
|--|--|
| 1 Reservoir for the headlamp and windshield washer system 86 | 4 Reservoir for brake fluid 88 |
| 2 Engine oil filler neck 87 | 5 Chassis ground, negative terminal |
| 3 Auxiliary terminal for jump-starting 97 | 6 Engine oil dipstick 86 |
| | 7 Coolant expansion tank 87 |

Washer fluids for washer systems

Headlamp* and windshield washer system



Capacity of windshield washer system: approx. 3.2 quarts/3 liters.

Capacity when equipped with headlamp washer system: approx. 5.3 quarts/5 liters.

Fill with water and, if required, with an antifreeze agent according to the manufacturer's recommendations.

 We recommend that you mix the washer fluid before adding it to the reservoir. ◀

 Antifreeze agents for the washing systems are highly flammable. For this reason, keep them away from sources of flame and store them only in their original containers. Store them so that they are inaccessible to children. Comply with the instructions on the containers. ◀

Engine oil

Oil consumption is directly influenced by your driving style and vehicle operating conditions.

Warning lamp

Engine oil pressure

 The warning lamp lights up in red:
The engine oil pressure is too low.
Stop the vehicle immediately and switch off the engine. Check the engine oil level and top up if necessary. If the oil level is correct, please contact the nearest BMW center.

 Do not continue driving, as the engine could sustain serious damage from inadequate lubrication. ◀

Engine oil level

 The warning lamp lights up in yellow while driving:
The oil level is at the absolute minimum; refill as soon as possible. Do not drive more than 30 miles/50 km before refilling.

 The warning lamp lights up in yellow after the engine has been switched off:
Add engine oil at the earliest opportunity, e.g. when you stop to refuel.

Engine oil sensor

 The warning lamp lights up in yellow within 20 seconds after the engine is started:

The oil level sensor is defective. Please have it checked by a BMW center.

Checking the oil level



1. With the vehicle's engine at normal operating temperature, i.e. after uninterrupted driving for at least 6 miles/10 km, park the vehicle on a level surface
2. Switch off the engine
3. After approx. 5 minutes, pull the dipstick out and wipe it off with a clean lint-free cloth, paper towel, or similar material
4. Carefully push the dipstick all the way into the guide tube and pull it out again
5. The oil level should be between the two marks on the dipstick

- Return the dipstick to the guide tube, inserting it as far as it will go.

As with fuel economy, oil consumption is directly influenced by your driving style and vehicle operating conditions.

The oil volume between the two marks on the dipstick corresponds to approx. 1.1 quarts/ 1 liter.

 Do not fill beyond the upper mark on the dipstick. Excess oil will damage the engine. ◀

Adding engine oil



Do not add oil until the oil level has dropped almost to the lower mark on the dipstick, refer to page 86.

 Add oil within the next 30 miles/50 km, otherwise the engine could be damaged. ◀

 Continuous exposure to used oil has caused cancer in laboratory tests. For this reason, thoroughly wash any areas of skin that come into contact with oil using soap and water. Always store oils, grease and similar materials so that they are inaccessible to children. Comply with warning labels and the information on the containers. ◀

 Comply with the applicable environmental laws regulating the disposal of used oil. ◀

Oil change

Have your oil changed only by a BMW center or a workshop that works according to BMW requirements with the appropriately trained personnel.

Approved engine oils

The quality of the engine oil is extremely important for the function and life of an engine. Based on extensive testing, BMW has approved certain grades of engine oil.

Use approved High Performance Synthetic Oil.

If you are unable to obtain an approved High Performance Synthetic Oil, you may use small volumes of other synthetic oils for topping up between oil changes. Use only oils with the specification API SH or higher.

 Ask your BMW center for details concerning the specific High Performance Synthetic Oil or synthetic oils that have been approved. ◀

You can also call BMW of North America toll-free at 1-800-831-1117 or visit this website: www.bmwusa.com to obtain this information.

 BMW engines are designed to operate without oil additives; the use of additives could even lead to damage in some cases. ◀

Coolant

Warning lamp



The warning lamp lights up: The coolant level is too low. Top up the coolant as soon as possible.

 Do not open the cooling system when the engine is hot. If you do, escaping coolant can cause burns. ◀

Coolant consists of water and coolant additives. Not all commercially available additives are suitable for your BMW. Your BMW center knows which additives are appropriate.

 Use only approved additives, as the engine could otherwise be damaged. The additives are hazardous to health. ◀

 Comply with the applicable environmental laws regulating the disposal of coolant additives. ◀

Checking the coolant level

1. The engine must be at ambient temperature
2. Open the cap of the expansion tank by turning it slightly counterclockwise to allow accumulated pressure to escape, then open completely
3. The coolant level is correct when the upper end of the red float is at least even with the upper edge of the filler neck but no more than 3/4 in/2 cm above it, that is up to the second mark on the float. Refer also to the schematic diagram next to the filler neck



4. Slowly add coolant, if necessary, until the correct level is reached; do not overfill
5. Turn the cap clockwise until it is tightly closed
6. Have the cause for the coolant loss removed as soon as possible.



Indication of the above-described malfunction in Canadian models.

Brake pads



The warning lamp lights up. The brake pads have worn down to the minimum safe limit. Have the brake pads replaced as soon as possible.



For your own safety: use only brake pads which BMW has approved for your specific vehicle model. BMW cannot evaluate non-approved brake pads to determine if they are suitable for use, and therefore cannot guarantee the operating safety of the vehicle in the event of their use. ◀

Brake system

Malfunction

Brake fluid

BRAKE The warning lamp lights up although the parking brake is not engaged: Stop the vehicle immediately.

The brake fluid level in the reservoir is too low. At the same time, you may notice that brake pedal travel is longer. Have the system checked as soon as possible.

! If you continue driving, extended pedal travel may be necessary and braking distances may be significantly longer. Be sure to adapt your driving style accordingly. ◀

Maintenance

The BMW Maintenance System

The BMW Maintenance System helps maintain the road safety and operating reliability of your BMW.

Please keep in mind that regular maintenance is not only necessary for the safety of your vehicle, but also plays a significant role in maintaining the resale value of your vehicle.

Service interval display



While conventional systems rely on distance traveled alone to determine when a service is due, the BMW Maintenance System has taken the actual conditions under which the vehicle is operated into consideration for years, because miles can be traveled in many different ways: From a maintenance point of view, 60,000 miles/100,000 km accumulated in short-distance urban driving are not the same as 60,000 miles/100,000 km accumulated at moderate cruising speeds in long-distance highway travel.

The BMW Maintenance System includes the Engine Oil Service and Inspections I and II.

Determining the maintenance intervals based on the actual loads on the vehicle covers every kind of operating situation. Minimal use drivers, who drive fewer than about 6,200 miles/10,000 km per year, should nevertheless have the oil changed at least every 2 years since engine oil deteriorates over time, regardless of use.

Service and Warranty Information Booklet for US models, Warranty and Service Guide Booklet for Canadian models

For additional information on required maintenance intervals and procedures, please refer to the Service and Warranty Information Booklet for US models, or the Warranty and Service Guide Booklet for Canadian models.

Depending on operating conditions, it may be advisable to have the body checked for damage from rocks or gravel as a precaution against corrosion.

 BMW recommends that you have your BMW center perform the maintenance and repair.

Be sure that all maintenance work is recorded in the Service and Warranty Information Booklet for US models, Warranty and Service Guide Booklet for Canadian models. These entries will serve as proof that the vehicle has received regular maintenance. ◀

OBD interface socket



The Onboard Diagnostic OBD interface socket is located on the left of the driver's side under the instrument panel and under a cover. The cover has the letters OBD on it.

The purpose of the OBD system is to ensure proper operation of the emission control system for the vehicle's lifetime.

The system monitors emission-related components and systems for deterioration and malfunction.

SERVICE ENGINE SOON If the Service engine soon indicator lamp comes on either continuously or intermittently, this indicates a fault in the emission-related electronic systems. Although the vehicle remains operational, you should have the systems checked by your BMW center at the earliest possible opportunity.

The illuminated indicator informs you of the need for service, not that you need to stop the vehicle. However, the systems should be checked by your BMW center at the next opportunity.

If the indicator blinks or flashes, this indicates a high level of engine misfire. Reduce speed and contact the nearest BMW center immediately. Severe engine misfiring over even a short period of time can seriously damage emission control system components, especially the catalytic converter.



Indication of the above-described malfunction in Canadian models.



If the gas cap is not on tight enough, the OBD system can detect leaking vapor and the indicator will light up. If the gas cap is then tightened, the indicator will usually go out after a short period of time. ◀

Event Data Recorders

Your vehicle may be equipped with one or more sensing and diagnostic modules or a recording device capable of recording or transmitting certain vehicle data or information. In addition, if you have a Subscription Service Agreement for the BMW Assist system, certain vehicle information may be transmitted or recorded in order to provide such services.

Care

Interesting facts about the care of your vehicle are found in the Caring for your vehicle brochure.

Replacement procedures

Onboard tool kit

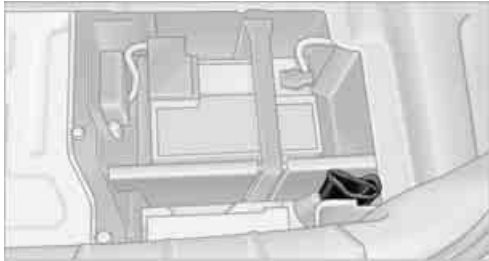

The onboard tool kit is stored in a tool pouch. It is located in the luggage compartment beneath the floor panel.

Windshield wiper blades

1. Switch off the ignition
2. Fold the wiper arm completely out from the windshield
3. Place the wiper blade in a position at right angles to the wiper arm
4. Press the locking spring



5. Fold the wiper blade down and unhook it toward the windshield
6. Pull the wiper blade past the wiper arm toward the top
7. Insert a new wiper blade and apply pressure until you hear it engage.

Lamps and bulbs

The lamps and bulbs make essential contributions to the safety of your vehicle. Therefore, comply fully with the following instructions during bulb replacement. If you are not familiar with the procedures, BMW recommends that you have your BMW center carry out the work.

 Do not touch the glass portion of a new bulb with your bare hands since even small amounts of impurities burn in to the surface and reduce the service life of the bulb. Use a clean cloth, paper napkin or a similar material, or hold the bulb by its metallic base. ◀

A replacement bulb set is available from your BMW center.

 Before working on the electrical system, switch off the electrical accessory you are working on or disconnect the cable from the negative terminal of the battery. Failure to observe this precaution could result in short circuits.

To prevent injuries and damage, always comply with any instructions provided by the bulb manufacturer. ◀

Accessing the headlamps

Protective cover in the wheel well



To gain access to the headlamp covers, turn the front wheels in the required direction.

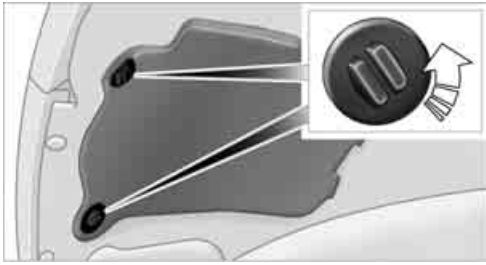

1. Open the caps with a suitable object, e.g. a coin or screwdriver
2. Fold up the protective cover in the wheel well.

Headlamp cover

1. Pull the wire clamp out straight



2. Pull the wire clamp past the catches, see arrows, and fold it down

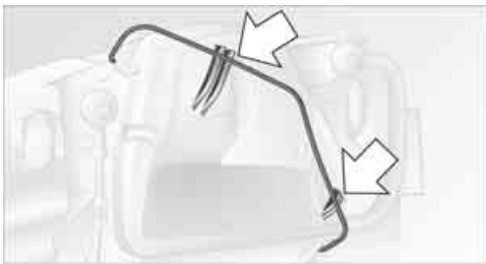

3. Flip the headlamp cover open and remove.

⚠ Reinstall the headlamp cover carefully. If it is not on tight, the headlamp installation could be damaged. ◀

Reinstall the headlamp cover in reverse order.

Low beams and high beams

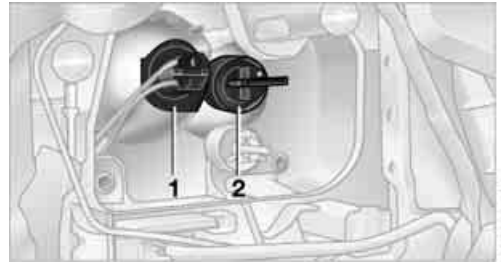

Left side of engine compartment:

- 1 Low beams
 - 2 High beams
- H7 bulb, 55 watts

⚠ The H7 bulb is pressurized. Therefore, wear safety glasses and protective gloves. Failure to comply with these precautions could result in physical injury if the bulb is damaged. ◀

1. Turn the bulb holder to the left and pull out
2. Remove and replace the bulb
3. Install in the reverse order.

▶ When cleaning the headlamps, please observe the instructions in the Caring for your vehicle brochure. ◀

Xenon lamps*

The service life of these bulbs is very long and the probability of a failure is very low, provided that they are not switched on and off an unusual number of times. If one of these bulbs should nevertheless fail, it is possible to continue driving with great caution using the fog lamps, provided traffic laws in your area do not prohibit this.

⚠ Because of the extremely high voltages involved, any work on the xenon lighting system, including bulb-changing, should be carried out by technically qualified personnel only. Otherwise, there is a risk of fatal injury. ◀

Front turn signal indicators

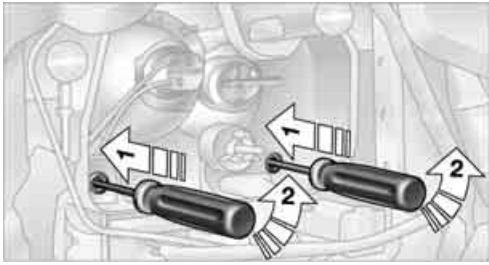

21 watt bulb

1. Insert a Phillips-head screwdriver from the onboard toolkit into the appropriate opening, arrows 1
2. Turn the screwdriver to the left, arrows 2
3. Use the Phillips-head screwdriver to pull out the entire bulb holder

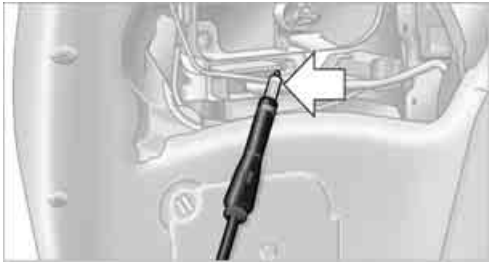

4. Replace the bulb
5. Install in the reverse order.

Side turn signal indicators

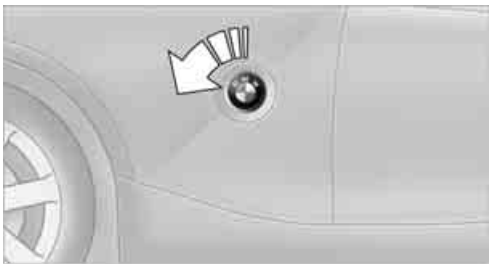

5 watt bulb

1. Turn the lamp to the left and remove
2. Apply gentle pressure to the bulb while turning it to the left to remove
3. Install in the reverse order.

Rear lamps

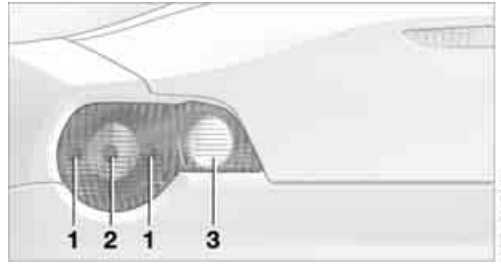

Tail lamps 1: 21/4 watt bulbs

Remaining bulbs: 21 watt

- 1 Tail lamp/brake lamp, red
- 2 Turn signal indicator, yellow
- 3 Backup lamp, white

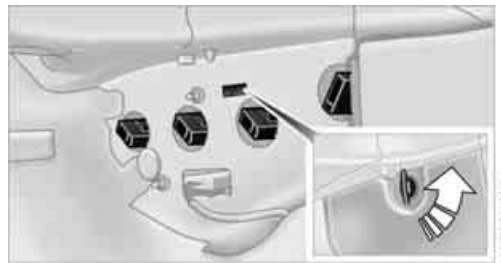

On the right-hand side of the luggage compartment:

1. Remove the cover by turning the lock to the right; refer to the detail in the illustration
2. Applying light pressure, turn the bulb to the left. Remove and exchange the bulb
3. Reinstall the cover.

Center high-mount brake lamp



The LED strip is in the luggage compartment lid.

Please contact a BMW center in case of a malfunction.

License plate lamps

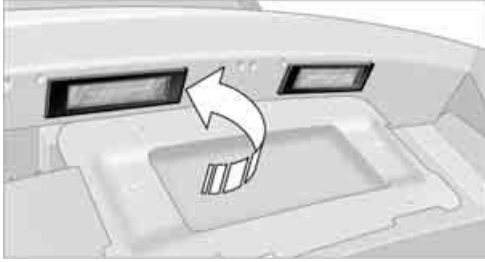

5 watt bulb

1. Push out the lamp with a suitable object and remove it
2. Replace the bulb.
Snap the lamp back into place.

Light-emitting diodes LEDs

Control elements, display units and other interior equipment in your vehicle use a light-emitting diode behind a cover as a light source. These light-emitting diodes are similar to conventional lasers.

 Do not remove the covers, and do not look directly at the unfiltered light for several hours. Otherwise, it can lead to retinal irritation of the eye. ◀

Changing a wheel

Run Flat tires

Your BMW is equipped with Run Flat tires. Therefore, the wheel no longer has to be changed immediately in the event of a loss in inflation pressure. Run Flat tires are labeled on the sidewall with a circular symbol containing the letters RSC. Refer to page 82.

BMW recommends that you consult your BMW center if you wish to replace the tires of your BMW, or change from summer to winter tires or vice versa.

Your BMW center knows how to work with Run

Flat tires and is equipped with the necessary special tools.

 When mounting or replacing summer tires with winter tires, or vice versa, use only Run Flat tires since no spare wheel is available in the event of a flat. ◀

Jacking points

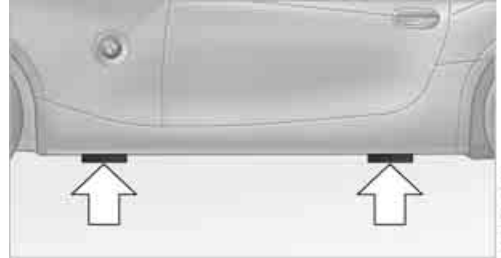

The jacking points are located at the positions indicated in the illustration.

 Your BMW center can provide you with a suitable jack as an accessory. ◀

Vehicle battery

Maintenance

The battery is completely maintenance-free. This means that the original electrolyte will normally last for the service life of the battery under moderate climatic conditions. Your BMW center will be happy to advise you if you have any questions concerning the battery.

Indicator lamp



The indicator lamp lights up:
The battery is no longer being charged.
The alternator drive belt is defective or there is a malfunction in the charging circuit of the alternator. Please contact the nearest BMW center.

 If the drive belt is defective, pull over and switch off the engine immediately to prevent overheating and serious engine damage. If the onboard supply voltage drops to a very low level, increased steering effort may also be necessary. ◀

Charging the battery

Charge the battery in the vehicle only when the engine has been switched off. Terminals, refer to Jump starting, page 97.

Battery disposal



After changing a battery, have the used battery disposed of by your BMW center or bring it to a recycling point. Maintain the battery in an upright position for transport and storage. Secure the battery against tilting when transporting. ◀

Power loss

After a temporary power loss, e.g. due to a discharged battery, some equipment will be limited in its use and must be reinitialized. Individual settings are also lost and must be reset:

- ▷ Seat memory
The positions must be stored again, refer to page 29
- ▷ Time
must be reset, refer to page 47.

Fuses

You will find the fuses and information on their respective allocation behind the glove compartment.

1. Open the glove compartment

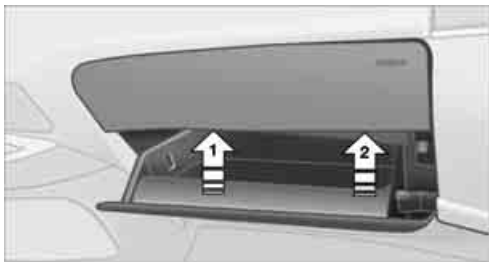

2. Press the lock on the left; see arrow 1
3. Press the lock on the right; see arrow 2
4. Swing the glove compartment down.

Spare fuses and plastic tweezers for grasping the fuses are found in the onboard tool kit; refer to page 91.



Do not attempt to repair a burned fuse or replace it with a fuse having a different color or amperage rating. To do this could cause a fire in the vehicle as a result of circuit overload. ◀

Giving and receiving assistance

Receiving assistance

The BMW Group's Mobile Service offers you 24-hour assistance in the event of a breakdown, even on weekends and holidays.

The telephone number of the Mobile Service control center in your country is listed in the Contact brochure.

If your vehicle has the necessary equipment, you can contact the Mobile Service or issue an emergency call using buttons in the center console, behind the parking brake under a cover.

When the emergency call is initiated, a telephone connection is established with the BMW Assist response center.

If your vehicle is equipped with an activated BMW Assist and the current location of the vehicle can be determined, this location is transmitted to the BMW Assist response center.

Requirements for initiating an emergency call or contacting Mobile Service:

- ▷ Ignition key in position 1 or higher
- ▷ The car phone must be registered with a mobile network
- ▷ The emergency call system must be operational.

Access to the buttons



Fold up the cover.

- 1 Emergency call
- 2 Roadside Assistance

Initiating an emergency call*

Press button **1** for at least 2 seconds.

The indicator lamp in the button lights up. As soon as a telephone connection to the BMW Assist response center has been set up, the indicator lamp flashes.

If the indicator lamp is flashing but you cannot hear the emergency call center, you may still be heard by the emergency call center.

 For technical reasons, the emergency call function cannot be guaranteed in certain unfavorable conditions. ◀

If certain requirements are met, an emergency call is automatically initiated after a serious accident. The automatic emergency call will not be hindered by pressing the button.

Roadside Assistance*

Press button **2** for at least 2 seconds.

The indicator lamp in the button lights up. As soon as a telephone connection to the Roadside Assistance has been set up, the indicator lamp flashes.

Depending on the country you are in, your vehicle's current location will also be transmitted if your vehicle is equipped with an activated BMW Assist function.

Warning triangle*



The warning triangle is stored in the rear luggage compartment panel.

Pull the ends of the rubber bands upward and out of the fasteners.

 Always observe all legal regulations requiring a warning triangle to be carried in the vehicle. ◀

First-aid kit*



The first-aid kit is located beneath the passenger seat.

To open

Pull the handle and fold the cover downward.

To close

Fold the cover up and engage the catch.

 Some of the articles in the first-aid kit have a limited period of use before expiration. For this reason, check the expiration dates of each of the items regularly, and replace any with passed dates. These items can be purchased in any drugstore or pharmacy. Always observe all legal regulations requiring a first-aid kit to be carried in the vehicle. ◀

Jump-starting

When your battery is discharged you can use two jumper cables to start your vehicle with power from the battery in a second vehicle. You can also use the same method to help start another vehicle. Always use jumper cables with fully insulated handles on the terminal clamps.

 Do not touch components carrying current on a running engine. Contact with these components can cause fatal injury. Care-

fully observe the following instructions to avoid personal injury and/or damage to one or both vehicles. ◀

Preparations

1. Check whether the battery of the support vehicle has 12 volts and approximately the same capacity – measured in Ah. This information is provided on the battery
2. Stop the engine of the support vehicle
3. Switch off all electrical accessories in both vehicles.

 Make absolutely certain that there is no contact between the bodywork of the two vehicles: short circuit hazard. ◀

Connecting jumper cables

 Always adhere to this sequence when connecting jumper cables; failure to observe this procedure can lead to sparks at the battery terminals and pose an injury hazard. ◀

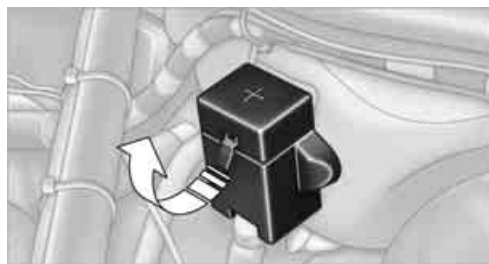

The auxiliary jump-starting terminal located in your BMW's engine compartment acts as the positive battery terminal. Refer to the engine compartment overview on page 85. The cover is marked with a +.

1. Open the cover of the BMW auxiliary jump-starting terminal. Do so by pulling the tab
2. With the + jumper cable, connect the positive terminal of the drained battery and the positive terminal of the support battery. To do this:
Connect one terminal clamp to the positive terminal of the battery or to an auxiliary jump-starting terminal of the support vehicle.
Connect the second terminal clamp to the

positive terminal of the battery or to an auxiliary jump-starting terminal of the vehicle to be jump-started.



Your BMW is equipped with a special nut, refer also to the engine compartment overview on page 85

3. With the – jumper cable, connect the negative terminals of both vehicles.
To do this:
Attach one cable clamp to the negative battery terminal or to a suitable ground on the engine or body work of the support vehicle. Attach the second cable clamp to the negative battery terminal or to a suitable ground on the engine or body work of the vehicle to be jump-started.

Starting the engine

1. Start the engine of the support vehicle and let it run for several minutes at a slightly elevated engine idle speed
2. Start the engine of the other vehicle as usual.
If the first start attempt is not successful, wait a few minutes before another attempt in order to allow the discharged battery to recharge
3. Allow the engines to run for several minutes
4. Then disconnect the jumper cables in reverse sequence
5. Depending on the cause of the fault, have the battery checked and recharged.

 Never use spray starter fluids to start the engine. ◀

Towing and tow-starting the vehicle

Using the towing eyelet

The screw-in towing eyelet is stored in the onboard tool kit; be sure that it remains in the vehicle at all times. It can be attached at the front or rear of your BMW.

 Observe the following instructions in order to avoid damaging the towing eyelet or the vehicle: use only the towing eyelet supplied with the vehicle, and screw it in firmly until it stops. Use the towing eyelet for towing on paved roads only. Avoid subjecting the towing eyelet to lateral loads, e.g. do not lift the vehicle using the towing eyelet. ◀

Access to the threaded socket

Press out the cover with a screwdriver inserted in the recess at the top.

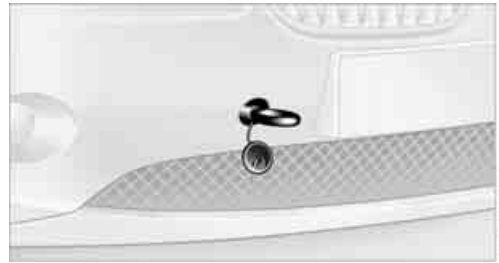

Being towed

 Make sure that the ignition key is in position 1, because the steering lock could otherwise engage and the vehicle could no longer be steered. There is no power assist while the engine is off. Therefore, you will need to exert more force to brake and steer the vehicle. ◀

Turn on the hazard warning flashers, if required by national regulations. If the electrical system has failed, clearly identify the vehicle being towed, e.g. by placing a sign or a warning triangle in the rear window.

Vehicles with manual transmission

Gearshift lever in idling position.

Vehicles with automatic transmission

Selector lever in position N.

⚠ Do not exceed a towing speed of 45 mph / 70 km/h or a towing distance of 90 miles / 150 km. Otherwise, the automatic transmission could be damaged. ◀

Vehicles with sequential manual gearbox SMG

To push or tow the vehicle, turn on the ignition and move the selector lever to position N, then turn the ignition off again.

Towing methods

In some countries, it is not permitted to tow the vehicle with a tow bar or tow rope on public roads.

Familiarize yourself with the applicable towing regulations for the country in which you are driving.

With a tow bar

⚠ The towing vehicle must not be lighter than the vehicle being towed; otherwise, vehicle handling can no longer be controlled. ◀

The towing eyelets of both vehicles should be on the same side. If the tow bar can only be used in a diagonal position, please note the following:

- ▷ Clearance is restricted while you are driving around corners
- ▷ The inclination of the tow bar produces lateral force.

⚠ Only attach the tow bar to the towing eyelets. Other parts of the vehicle could otherwise be damaged. ◀

With a tow rope

When the towing vehicle is driving off, make sure that the tow rope is taut.

⚠ Use nylon ropes or straps for towing because they prevent sudden jerking movements. Attach tow ropes only to the towing eyelet. Other parts of the vehicle could otherwise be damaged. ◀

With a tow truck

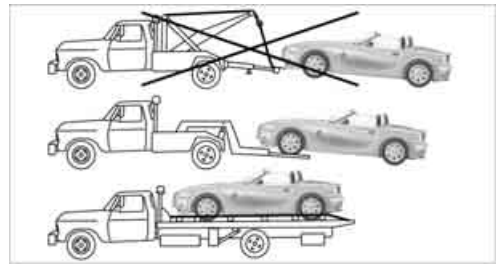

Have the BMW transported by a tow truck with a lift sling, or on a flatbed.

⚠ Do not lift the vehicle by the towing eyelet, or by parts of the body or chassis. Otherwise damage could result. ◀

Tow-starting

▶ Do not tow-start vehicles with automatic transmission.

Jump-starting, refer to page 97. ◀

Only tow-start vehicles with catalytic converters if the engine is cold. It is better to have the vehicle jump-started, refer to page 97.

1. Turn on the hazard warning flashers; comply with national regulations
2. Turn the ignition key to position 2
3. Engage the 3rd gear. For vehicles with SMG, refer to following column
4. Have the vehicle towed with the clutch pedal completely depressed and then slowly release the clutch pedal. After the engine has started, immediately depress the clutch pedal again completely
5. Pull over at a suitable location, remove the tow bar or tow rope, and turn on the hazard warning flashers
6. Have the vehicle checked.

Vehicles with sequential manual gearbox SMG

- ▷ Have the vehicle towed with the selector lever in position N
- ▷ Select sequential mode. The correct gear will automatically be selected and engaged.



Reference

This chapter will help you find the desired information as quickly as possible. It contains the Technical data section as well as the manual's index.

Technical data

Engine data

		Z4 2.5i	Z4 3.0i
Displacement	cu in/cm ³	152.1/2,494	181.7/2,979
Number of cylinders		6	6
Maximum power output	hp/kW	184/141	225/170
at engine speed	rpm	6,000	5,900
Maximum torque	lb ft/Nm	181/245	221/300
at engine speed	rpm	3,500	3,500

Weights

		Z4 2.5i	Z4 3.0i
Curb weight			
with manual transmission	lbs/kg	2,932/1,330	2,998/1,360
with SMG	lbs/kg	2,976/1,350	3,020/1,370
with automatic transmission	lbs/kg	2,998/1,360	3,042/1,380
Approved gross vehicle weight			
with manual transmission	lbs/kg	3,483/1,580	3,549/1,610
with SMG	lbs/kg	3,527/1,600	3,571/1,620
with automatic transmission	lbs/kg	3,549/1,610	3,593/1,630
Load			
Approved front axle load	lbs/kg	1,720/780	1,742/790
Approved rear axle load	lbs/kg	1,841/835	1,863/845
Luggage compartment capacity	cu ft/l	8.5/240	8.5/240
with convertible top compartment panel raised	cu ft/l	9.2/260	9.2/260
Never exceed either the approved axle loads or the approved gross vehicle weight.			

Dimensions

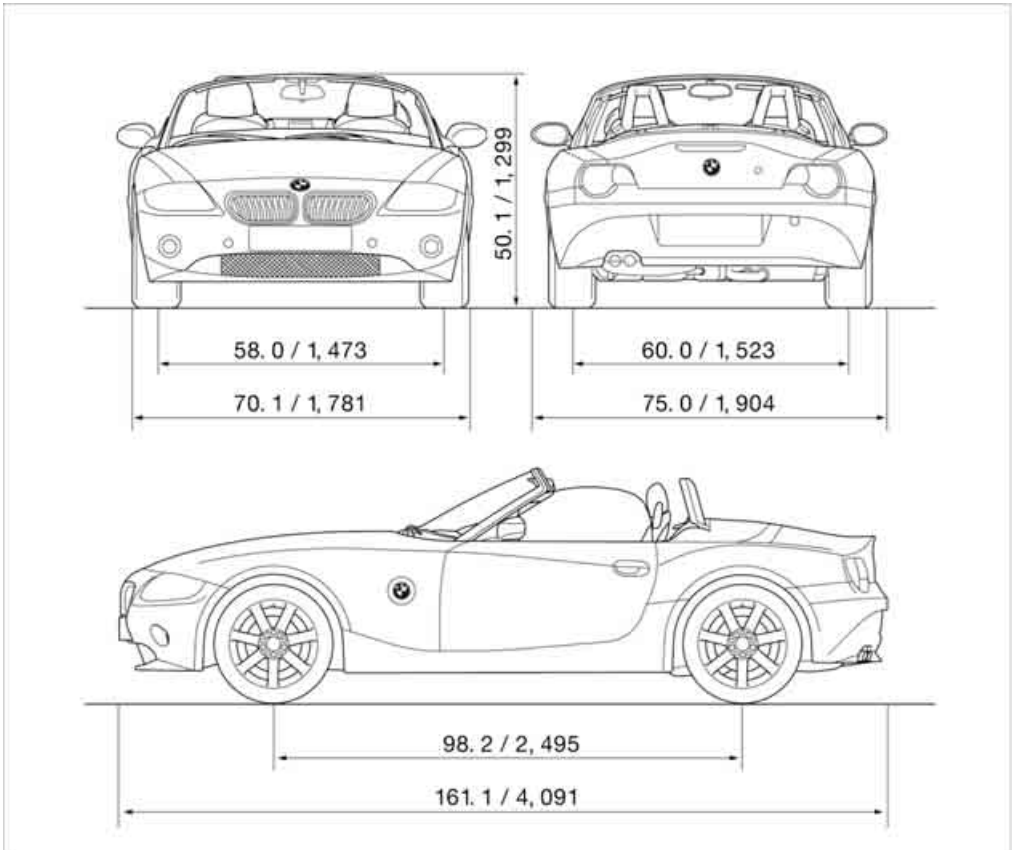

All measurements in inches/millimeters. Smallest turning circle dia. 32 ft 2 in/9.8 m.

Capacities

Notes

Fuel tank	gal./liters	approx. 14.5/55	Fuel specifications: page 76
reserve	gal./liters	approx. 2.1/8	
Windshield washer system/	quarts/liters	approx. 3.2/3	For details: page 86
Headlamp washer system	quarts/liters	approx. 5.3/5	
Cooling system including heating circuit			For details: page 87
with manual transm. or SMG	quarts/liters	8.8/8.3	
with automatic transmission	quarts/liters	9.3/8.8	
Engine with oil filter renewal	quarts/liters	6.9/6.5	For details: page 87

At a glance

Controls

Driving tips

Mobility

Reference

Everything from A to Z

Index

A

ABS Antilock Brake

System 50

– indicator lamp 13

Acceleration assistant 42

Accessories, refer to

– For your own safety 6

– Your individual vehicle 5

Accident, refer to Emergency call 96

Acknowledgment signal for vehicle locking/unlocking 16

Activated-charcoal filter 63

Adjusting the thigh support 29

Air, drying,

refer to Air conditioning

mode 59, 62

Airbags 53

– deactivation 33

– indicator lamp 12

– passenger airbags indicator lamp 34

– reactivation 33

– safe seating position 27

Airbag switch 33

Air conditioning 58

Air conditioning mode

– air conditioning 59

– automatic climate control 62

Air conditioning mode

switching on/off

manually 59, 62

Air distribution

– air conditioning 59

– automatic climate control 62

Airing out, refer to

Ventilation 59, 63

Air outlets,

refer to Ventilation 59, 63

Air pressure, refer to Tire

inflation pressure 78

Air recirculation, refer to

Recirculated air

mode 59, 62

Air supply/blower

– air conditioning 59

– automatic climate control 62

AKI, refer to Fuel

specifications 76

Alarm system 25

– avoiding unintentional alarms 26

All-season tires, refer to

Winter tires 81

Antenna, refer to the

Caring for your vehicle brochure

Antifreeze 86, 87

– coolant 87

– washing fluids 86

Antilock Brake System

ABS 50

– indicator lamp 13

Anti-theft alarm system, refer

to Alarm system 25

Anti-theft protection 16, 25

Approved axle load, refer to

Weights 103

Approved engine oils 87

Approved gross vehicle

weight, refer to Weights 103

Artificial leather, refer to the

Caring for your vehicle brochure

Ashtray 65

Assistant systems,

refer to Dynamic Stability Control DSC 50

AUC Automatic recirculated

air control 62

Automatic

– air distribution 62

– air supply/blower 62

– cruise control 44

– headlamp control 56

– luggage compartment lid operation 19

Automatically dimming

interior rearview mirror 31

Automatic car wash, refer to the Caring for your vehicle brochure

Automatic climate control 61

Automatic recirculated air

control AUC 62

Automatic transmission with

Steptronic 38

– ignition 36

– indicator lamp 13

– interlock 36

– selector lever lock 38

– shiftlock 38

– towing the vehicle 99

– tow-starting 99

AUTO program,

refer to Automatic air

distribution 62

Average fuel consumption 49

– setting unit of measure 48

Average speed 49

– setting unit of measure 48

Avoiding unintentional

alarms 26

Axle loads, refer to

Weights 103

B

Backrest, refer to Seat

adjustment 28

Backup lamps 38

– bulb replacement 93

Bandages, refer to First-aid kit [97](#)
Bar, towing [99](#)
Battery [94](#)
– charging [95](#)
– disposal [95](#)
– indicator lamp [12, 94](#)
– jump-starting [97](#)
– power supply interruption [95](#)
– remote control [16](#)
Belts, refer to Safety belts [30](#)
Belt tensioner, refer to Safety belts [30](#)
Beverage holders [64](#)
Blower
– air conditioning [59](#)
– automatic climate control [62](#)
Blower, refer to Air supply [59, 62](#)
BMW [5](#)
BMW Maintenance System [89](#)
Bottle holders, refer to Beverage holders [64](#)
Brake fluid [88](#)
– filling [88](#)
– indicator/warning lamp [13, 88](#)
– level [88](#)
Brake force display [52](#)
Brake hydraulic system [88](#)
– indicator/warning lamp [13, 88](#)
Brake lamps
– brake force display [52](#)
– bulb replacement [93](#)
– indicator lamp, defective lamp [13](#)
Brake pads [88](#)
– break-in procedures [68](#)
– warning lamp [88](#)
Brake pad wear indicator
– brake pads [88](#)
– warning lamp [13](#)
Brake rotors
– brake system [69](#)
– break-in procedures [68](#)

Brakes
– ABS [50](#)
– brake fluid [88](#)
– brake pads [88](#)
– break-in procedures [68](#)
– indicator/warning lamps [13, 51](#)
– parking brake [37](#)
Brake system
– brake fluid [88](#)
– brake pads [88](#)
– break-in procedures [68](#)
– disc brakes [69](#)
– indicator lamp [13](#)
Breakdown
– Flat Tire Monitor [52](#)
Breakdown service, refer to Mobile Service [96](#)
Breaking in the differential, refer to Engine and differential [68](#)
Break-in procedures [68](#)
Bridging, refer to Jump-starting [97](#)
Bulb replacement, refer to Lamps and bulbs [91](#)
Buttons in the multifunction steering wheel [10](#)

C

California laws
– Event Data Recorders [90](#)
– Proposition 65 warning [6](#)
Can holders, refer to Beverage holders [64](#)
Capacities [105](#)
Capacity
– luggage compartment, refer to Weights [103](#)
Car battery [94](#)
Car care, refer to the Caring for your vehicle brochure
Car-care products, refer to the Caring for your vehicle brochure
Care, refer to the Caring for your vehicle brochure
Car keys, refer to Keys [16](#)

Carpet care, refer to the Caring for your vehicle brochure
Car radio, refer to the separate Owner's Manual
Car telephone, refer to the separate Owner's Manual
Car wash, refer to the Caring for your vehicle brochure
Catalytic converter, refer to Hot exhaust system [69](#)
CD changer, refer to Owner's Manual for Radio/Onboard Computer
CD operation, refer to Owner's Manual for Radio/Onboard Computer
Center high-mount brake lamp, bulb replacement [93](#)
Central locking system [16](#)
– interior [18](#)
Changes, technical, refer to For your own safety [6](#)
Changing a wheel [94](#)
– Run Flat tires [94](#)
Charge indicator lamp [12, 94](#)
Check gas cap, indicator lamp [13](#)
Child-restraint mounting system, LATCH [35](#)
Child-restraint systems [33](#)
Child seat, refer to Installing child-restraint systems [34](#)
Chrome parts, refer to the Caring for your vehicle brochure
Cigarette lighter [65](#)
Cigarette lighter socket [65](#)
Cleaning the rear window, refer to the Caring for your vehicle brochure
Cleaning the vehicle, refer to the Caring for your vehicle brochure

- Clock [47, 48](#)
 - 12- or 24-hour mode [48](#)
 - refer to Owner's Manual for Radio/Onboard Computer
 - setting [47](#)
 - Clothes hooks [25](#)
 - Clutch, break-in procedures [68](#)
 - Cockpit [10](#)
 - Cold start, refer to Starting the engine [36](#)
 - Compact disc operation, refer to Owner's Manual for Radio/Onboard Computer
 - Compartments [64](#)
 - Computer [48](#)
 - clock, 12- or 24-hour mode [48](#)
 - refer to Owner's Manual for Onboard Computer
 - Computer, refer to Onboard Computer [48](#)
 - Condensation, refer to Air conditioning mode [59, 62](#)
 - Condensation, removing from windows
 - air conditioning [60](#)
 - automatic climate control [62](#)
 - Configuring settings, refer to Vehicle Memory, Key Memory [31](#)
 - Connecting a vacuum cleaner, refer to Power socket [65](#)
 - Consumption, refer to Average consumption [49](#)
 - Consumption display, refer to Fuel gauge [46](#)
 - Contents [3](#)
 - Control elements, refer to Cockpit [10](#)
 - Controls, lighting, refer to Instrument lighting [57](#)
 - Convenience operation
 - convertible top [18](#)
 - from outside [18](#)
 - windows [18](#)
 - Convertible top [20, 21](#)
 - care, refer to the Caring for your vehicle brochure
 - convenience operation [18](#)
 - electrical fault [23](#)
 - emergency closing [23](#)
 - fully automatic [21](#)
 - malfunction [23](#)
 - manual [20](#)
 - mechanical [20](#)
 - Convertible top compartment panel [19](#)
 - Coolant [87](#)
 - indicator lamp [13](#)
 - level [88](#)
 - thermometer [46](#)
 - Coolant water, refer to Coolant [87](#)
 - Cooling
 - maximum [62](#)
 - refer to Air conditioning mode [59, 62](#)
 - Cooling system, refer to Capacities [105](#)
 - Copyright [2](#)
 - Correct tires [82](#)
 - Cruise control [44](#)
 - Cruising range [49](#)
 - Cup holders, refer to Beverage holders [64](#)
 - Curb weight, refer to Weights [103](#)
 - Cylinders, refer to Engine data [102](#)
- D**
- Dashboard, refer to Cockpit [10](#)
 - Data, technical [102](#)
 - capacities [105](#)
 - dimensions [104](#)
 - engine data [102](#)
 - weights [103](#)
 - Daytime driving lamps [56](#)
 - DBC Dynamic Brake Control [50](#)
 - warning lamp [13, 51](#)
 - Defective bulb [56](#)
 - Defrosting rear window
 - air conditioning [59](#)
 - automatic climate control [63](#)
 - Defrosting windows [60, 62](#)
 - Defrosting windows and removing condensation
 - air conditioning [60](#)
 - automatic climate control [62](#)
 - Defrosting windshield, refer to Defrosting windows [60, 62](#)
 - Defrost position, refer to Defrosting windows [60, 62](#)
 - Digital clock [47](#)
 - Dimensions [104](#)
 - Dimming mirrors [70](#)
 - Dipstick, engine oil [86](#)
 - Directional indicators, refer to Turn signal indicators [42](#)
 - Disc brakes [69](#)
 - Displacement, refer to Engine data [102](#)
 - Display elements [12](#)
 - Display lighting, refer to Instrument lighting [57](#)
 - Displays, refer to Instrument cluster [12](#)
 - Disposal
 - of engine oil [87](#)
 - vehicle battery [95](#)
 - Distance remaining, refer to Range [49](#)
 - Door key [16](#)
 - Door lock [17](#)
 - Doors, unlocking and locking
 - from inside [18](#)
 - from outside [16, 17](#)
 - DOT quality grades [80](#)
 - Draft-free ventilation [59, 63](#)
 - Driving Dynamic Control [41](#)
 - Driving light, refer to Parking lamps/Low beams [56](#)
 - Driving notes [68](#)
 - break-in procedures [68](#)
 - driving tips [68](#)
 - Driving stability control [50](#)
 - Driving stability control systems [50](#)

Dry air, refer to Air conditioning mode [59](#), [62](#)
 DSC Dynamic Stability Control [50](#)
 – indicator lamp [13](#), [51](#)
 DTC Dynamic Traction Control [50](#)
 – indicator lamp [13](#), [51](#)
 Dynamic Brake Control DBC [50](#)
 – indicator lamp [13](#)
 – warning lamp [51](#)
 Dynamic Stability Control DSC [50](#)
 – indicator lamp [13](#), [51](#)
 Dynamic Traction Control DTC [50](#)
 – indicator lamp [13](#), [51](#)

E

Electrical fault
 – automatic transmission with Steptronic [39](#)
 – convertible top [23](#)
 – door lock [18](#)
 – driver's door [18](#)
 – fuel filler door [76](#)
 – luggage compartment lid [18](#)
 – SMG [41](#)
 – storage compartments [64](#)
 Electric Power Steering EPS [42](#)
 – indicator lamp [13](#), [42](#)
 Electric power windows [20](#)
 – power loss [20](#)
 Electronic Stability Program ESP, refer to
 Dynamic Stability Control DSC [50](#)
 Electronic transmission control module [39](#)
 Emergency call [96](#)

Emergency operation, refer to
 Manual operation
 – convertible top [23](#)
 – doors [18](#)
 – driver's door [18](#)
 – fuel filler door [76](#)
 – luggage compartment lid [18](#)
 – storage compartments [64](#)
 Emergency service, refer to
 Mobile Service [96](#)
 Engine [36](#)
 – break-in procedures [68](#)
 – data [102](#)
 – electronics [13](#)
 – indicator lamp [13](#)
 – speed [46](#)
 – starting [36](#)
 – switching off [37](#)
 Engine compartment [85](#)
 Engine coolant [87](#)
 Engine coolant temperature gauge [46](#)
 Engine data [102](#)
 Engine oil [86](#)
 – alternative oils [87](#)
 – approved engine oils [87](#)
 – capacity [105](#)
 – indicator/warning lamp [13](#)
 Engine oil level [86](#)
 – indicator/warning lamp [13](#)
 Engine oil pressure [86](#)
 – indicator/warning lamp [13](#)
 Engine oil sensor [86](#)
 – indicator/warning lamp [13](#)
 Engine output, refer to Engine data [102](#)
 Engine speed, refer to Engine data [102](#)
 EPS Electric Power Steering [42](#)
 ESP Electronic Stability Program, refer to Dynamic Stability Control DSC [50](#)
 Exhaust system, refer to Hot exhaust system [69](#)
 Exterior mirrors [31](#)
 – automatic dimming feature [70](#)
 – folding in and out [31](#)

Eyelets, towing and tow-starting [98](#)

F

False alarm, refer to
 – Avoiding unintentional alarms [26](#)
 – Stopping the alarm [26](#)
 Fasten safety belts
 – refer to Safety belts [30](#)
 – warning lamp [12](#), [30](#)
 Fault
 – automatic transmission [39](#)
 – luggage compartment lid [18](#)
 – SMG [41](#)
 Filter, refer to
 – Microfilter [59](#)
 – Microfilter/activated-charcoal filter [63](#)
 Fine wood, refer to the
 Caring for your vehicle brochure
 Finger guard system, power windows [20](#)
 First aid, refer to First-aid kit [97](#)
 First-aid kit [97](#)
 Flat
 – Run Flat tires [82](#)
 Flat tire
 – Flat Tire Monitor [52](#)
 – indicator/warning lamp [13](#)
 – Run Flat tires [82](#)
 Flat tire, refer to
 – Changing a wheel [94](#)
 – Tire condition [81](#)
 Flat Tire Monitor [52](#)
 – indicator/warning lamp [13](#), [53](#)
 – initializing [52](#)
 – warning lamp [53](#)
 Flat tire service, refer to
 Mobile Service [96](#)
 Floods, refer to Driving through water [69](#)
 Floor covers, carpets, refer to the
 Caring for your vehicle brochure

Floor mats, refer to the Caring for your vehicle brochure
 Fluid reservoir, washer systems **86**
 Fog lamps **57**
 – indicator lamp **13**
 Follow me home lamps **56**
 Footbrake, refer to Driving notes **69**
 Front airbags **53**
 Fuel
 – average consumption **49**
 – display **46**
 – quality **76**
 – volume, refer to Capacities **105**
 Fuel display, refer to Fuel gauge **46**
 Fuel filler door **76**
 – unlocking in case of electrical fault **76**
 Fuel reserve indicator, refer to Fuel gauge **46**
 Fuel tank capacity, refer to Capacities **105**
 Fuses **95**

G

Gasoline, refer to Fuel quality **76**
 Gasoline gauge, refer to Fuel gauge **46**
 Gear indicator
 – for automatic transmission with Steptronic **38**
 – for sequential manual gearbox SMG **40**
 Gear lever
 – automatic transmission with Steptronic **38**
 – manual transmission **38**
 – sequential manual gearbox SMG **40**

Gear shifts
 – via automatic transmission with Steptronic **38**
 – via sequential manual gearbox SMG **41**
 Glove compartment **64**
 Gross weight, refer to Weights **103**

H

Handbrake, refer to Parking brake **37**
 Hands-free microphone, refer to Preparations for the cellular phone **65**
 Hands-free system **65**
 Hardtop, refer to the separate Owner's Manual
 Hardtop preparation **72**
 Hazard warning flashers **10**
 Headlamp cover, care, refer to the Caring for your vehicle brochure
 Headlamp flasher **42**
 – indicator lamp **13**
 Headlamps
 – bulb replacement **91**
 – care, refer to the Caring for your vehicle brochure
 – cleaning **43**
 Headlamps, automatic control **56**
 Headlamp washer reservoir **86**
 – volume, refer to Capacities **105**
 Headlamp washer system
 – cleaning the headlamps **43**
 – washing fluids **86**
 Head restraints **28**
 Heated mirrors **31**
 Heated seats **30**
 Heating **58**
 – exterior mirrors **31**
 – rear window **59, 63**
 – seats **30**

Heavy loads, refer to Stowing cargo **71**
 Height, refer to Dimensions **104**
 Height adjustment
 – seats **28**
 – steering wheel **31**
 High beams **57**
 – bulb replacement **92**
 – headlamp flasher **42**
 – indicator lamp **13**
 High Performance Synthetic Oil **87**
 – alternative oils **87**
 – approved oils **87**
 Holders for beverages **64**
 Hood **84**
 Horn **10**
 Hot exhaust system **69**
 Hydraulic Brake Assistant, refer to Dynamic Brake Control DBC **50**
 Hydraulics, brake **88**
 Hydroplaning **69**

I

Ice warning **48**
 Identification mark
 – Run Flat tires **82**
 – tire coding **80**
 Ignition **36**
 Ignition key **16**
 Ignition lock **36**
 Imprint **2**
 Inclines **69**
 Index **106**

Indicator/warning lamp
– airbags 54
– alarm system 26
– automatic transmission with Steptronic 39
– brakes 13
– coolant temperature 47
– DSC 51
– engine temperature 46
– Flat Tire Monitor 53
– fog lamps 57
– passenger airbags 34
– please fasten safety belts 30
– reserve 46
– sequential manual gearbox SMG 41
Indicator and warning lamps, overview 12
Individual air distribution 59, 62
Individual settings, refer to Vehicle Memory, Key Memory 31
Inflation pressure, tires 78
Inflation pressure monitoring, refer to
– Flat Tire Monitor 52
Inspection 47
Instrument cluster 12
Instrument lighting 57
Instrument panel, refer to Cockpit 10
Interior lamps 57
– remote control 17
Interior motion sensor 26
– deactivating 26
Interior rearview mirror 31
– automatic dimming feature 70
Interior temperature adjusting 59, 62
Interlock, refer to Steering lock 36
Intermittent
– operation, wipers 43
Interval
– display, service 47

J

Jack 94
Jacking points 94
Jets, refer to Ventilation 59, 63
Jump-starting 97

K

Key Memory 31
Keys 16
Key switch for passenger airbags 33
Kickdown 39
Knock control 76

L

Lamps and bulbs 91
LATCH, child-restraint mounting system 35
Leather care, refer to the Caring for your vehicle brochure
LEDs Light-emitting diodes 94
Length, refer to Dimensions 104
License plate lamps, bulb replacement 94
Light-alloy wheels, care, refer to the Caring for your vehicle brochure
Light-emitting diodes LEDs 94
Lighter 65
Lighting of the instruments 57
Lights, refer to Parking lamps/ Low beams 56
LIGHTS ON warning 56
Light switch 56
Load, vehicle 70
Loads, refer to Cargo loading 70
Loads, securing 71
Lock buttons on doors, refer to Locking 18

Locking the doors
– from inside 18
– from outside 17
Locking the vehicle
– from inside 18
– from outside 16
Low beams 56
– automatic 56
– bulb replacement 92
– indicator lamp, defective lamp 13
Lug bolts, wrench 91
Luggage compartment 19
– capacity 103
– floor panel 91
– increasing capacity 19
– opening/closing, refer to Luggage compartment lid 18
– opening from inside the vehicle 19
– opening from the outside 18
– opening with remote control 17
Luggage compartment lid 18
– emergency operation 19
– opening from inside the vehicle 19
– opening from the outside 18
– remote control 17

M

M+S tires, refer to Winter tires 82
Maintenance, refer to Service interval display 47, 89
Maintenance System 89
Making telephone calls, refer to Owner's Manual for Telephone
Malfunction
– convertible top 23
– door lock 18
– fuel filler door 76
– storage compartments 64
Malfunction of electrical accessory 95
Manual convertible top 20

Manual mode, refer to Automatic transmission with Steptronic [39](#)

Manual operation

- automatic transmission interlock [38](#)
- door lock [18](#)
- driver's door [18](#)
- fuel filler door [76](#)
- luggage compartment lid [18](#)
- power convertible top [23](#)
- storage compartments [64](#)

Manual transmission [38](#)

Manufacturer [5](#)

Master key [16](#)

- with remote control [16](#)

Maximum cooling [62](#)

Maximum speed, winter tires [82](#)

MD operation, refer to Owner's Manual for Radio/ Onboard Computer

Measurements, refer to Dimensions [104](#)

Mechanical seat [28](#)

Memory, refer to

- Seat Memory [29](#)
- Vehicle Memory, Key Memory [31](#)

Microfilter

- air conditioning [59](#)
- automatic climate control [63](#)

Microphone, refer to Preparations for the cellular phone [65](#)

Minidisc operation, refer to Owner's Manual for Radio/ Onboard Computer

Mirrors [31](#)

- heated [31](#)

Mobile phone, refer to separate Owner's Manual [5](#)

Mobile Service [96](#)

Modifications, technical, refer to For your own safety [6](#)

Monitoring system for tire pressures, refer to

- Tire inflation pressure [78](#)

M Sports seat [29](#)

Multifunction steering wheel, refer to Buttons in the steering wheel [10](#)

Multifunction switch

- turn signal indicators/ headlamp flasher [42](#)
- washer/wiper system [43](#)

N

Neck supports, refer to Head restraints [28](#)

Nets [64](#)

Nylon rope, refer to Towing and tow-starting [99](#)

O

OBD interface socket [90](#)

Octane numbers, refer to Fuel specifications [76](#)

Odometer [46](#)

Oil, refer to Engine oil

- additives, refer to Approved oils [87](#)
- alternative oils [87](#)
- approved oils [87](#)
- capacity [105](#)
- dipstick [86](#)
- indicator/warning lamp [13](#)

Oil change intervals, refer to the Service and Warranty Information Booklet for US models, Warranty and Service Guide Booklet for Canadian models

Oil consumption [86](#)

Oil filter change [105](#)

Oil level [86](#)

- checking [86](#)
- indicator lamp [13](#)
- oil pressure [86](#)
- indicator/warning lamp [13](#)

Oil sensor [86](#)

- indicator lamp [13](#)

Oil service [47](#)

Oil types [87](#)

Onboard computer

- button BC [48](#)

Onboard computer, refer to Computer or to the Owner's Manual for Onboard Computer

Onboard monitor, refer to Computer or to the Owner's Manual for Onboard Computer

Onboard tool kit [91](#)

Opening and closing the vehicle

- at the door lock [17](#)
- from inside [18](#)
- from outside [16, 17](#)
- with the remote control [16, 17](#)

Operating elements [10](#)

Outlets, refer to Ventilation [59, 63](#)

Outside air mode [59](#)

- air conditioning [59](#)

Outside air mode, automatic climate control [62](#)

Outside temperature display [47](#)

- changing units of measure [48](#)
- in the onboard computer [48](#)

P

Paintwork, refer to the Caring for your vehicle brochure

Parking brake [37](#)

- indicator lamp [13](#)

Parking lamps/Low beams [56](#)

Parking lock, refer to Parking [39](#)

Parts and accessories, refer to Your individual vehicle [5](#)

Passenger airbags

- deactivation [33](#)
- reactivation [33](#)

Placing the vehicle in storage, refer to the Caring for your vehicle brochure

Plastic, refer to the Caring for your vehicle brochure
Pollen, refer to
– Microfilter 59
– Microfilter/activated-charcoal filter 63
Power convertible top 21
Power loss
– electric power windows 20
Power output, refer to Engine data 102
Power seat 29
Power socket 65
Power steering, electric 42
Power supply interruption
– battery 95
Power windows
– initializing 20
Power windows protective function, refer to Trap protection 20
Preparations for the cellular phone 65
Pressure, tires 78
Pressure monitoring, tires, refer to Flat Tire Monitor 52

R

Radio, refer to the Owner's Manual for Radio
Radio navigation, refer to the separate Owner's Manual
Radio remote control key, refer to Master keys with remote control 16
Rain sensor 43
Reading lamps 57
Rear lamps
– bulb replacement 93
– indicator lamp, defective lamp 13
Rearview mirror 31
Rear window defroster
– air conditioning 59
– automatic climate control 63
Recirculated air mode
– air conditioning 59
– automatic climate control 62

Recirculating the air, refer to Recirculated air mode 59, 62
Reclining seat, refer to Seats 28
Refueling 76
– fuel filler door 76
Releasing
– hood 84
Remaining distance, refer to Range 49
Remaining distance to next service 47
Remote control 16
– luggage compartment lid 17
– malfunction 17
Replacement key 16
Replacement key, refer to New keys 16
Replacement of tires 82
– changing a wheel 94
– new wheels and tires 82
Replacing lamps, refer to Lamps and bulbs 91
Restraint systems
– for children 35
– refer to Safety belts 30
Reverse
– automatic transmission with Steptronic 39
– manual transmission 38
Reverse gear
– sequential manual gearbox SMG 40
Rod antenna, refer to the Caring for your vehicle brochure
Rope, refer to Towing and tow-starting 98
RSC Runflat System
Component, refer to Run Flat tires 82
Rubber parts, refer to the Caring for your vehicle brochure
Runflat System Component
RSC, refer to Run Flat tires 82

Run Flat tires 82
– changing a tire 81, 82
– changing a wheel 94
– flat tire 53
– tire inflation pressure 78
– winter tires 82

S

Safe seating position 27
– with airbags 27
– with safety belts 27
Safety belts 30
– care, refer to the Caring for your vehicle brochure
– safe seating position 27
– warning lamp 12, 30
Safety systems, refer to
– Airbags 53
– Antilock Brake System ABS 50
– Dynamic Stability Control DSC 50
Safety tires, refer to Run Flat tires 82
Screwdriver, refer to Onboard tool kit 91
Seat adjustment 28
– mechanical 28
– M Sports seat 29
– power 29
Seat heating 30
Seat memory 29
Seat position, storing 29
Seats 28
– adjusting the sports seat 29
– heating 30
– memory, refer to Seat memory 29
– power adjustment 29
– safe seating position 27
– storing positions 29
Securing, locking the vehicle
– from inside 18
– from outside 17
Securing loads, refer to Cargo loading 71

- Selector lever
 - automatic transmission with Steptronic [38](#)
 - sequential manual gearbox SMG [40](#)
- Selector lever lock, refer to Range selection [38](#)
- Selector lever positions
 - automatic transmission with Steptronic [38](#)
 - sequential manual gearbox SMG [40](#)
- Sequential manual gearbox SMG [40](#)
- Service, refer to Mobile Service [96](#)
- Service, refer to Service and Warranty Information Booklet for US models, Warranty and Service Guide Booklet for Canadian models [89](#)
- Service and warranty [7](#)
- Service interval display [47](#), [89](#)
- Shifting gears
 - automatic transmission with Steptronic [38](#)
 - manual transmission [38](#)
 - sequential manual gearbox SMG [41](#)
- Shiftlock, refer to Range selection [38](#)
- Shift paddles [41](#)
- Side airbags [53](#)
- Side turn signal indicators, bulb replacement [93](#)
- Signal horn, refer to Horn [10](#)
- Slipstream deflector, refer to Wind deflector [24](#)
- SMG Sequential manual gearbox [40](#)
- Smokers' package, refer to Ashtray [65](#)
- Snow chains [83](#)
- Socket for Onboard Diagnostics [90](#)
- SOS, refer to Emergency call [96](#)
- Spare fuses [95](#)
- Spare key [16](#)
- Spare wheel, refer to Run Flat tires [82](#)
- Special oils, refer to Specified engine oils [87](#)
- Special wash program, refer to the Caring for your vehicle brochure
- Specified engine oils [87](#)
- Speed
 - winter tires [82](#)
- Speedometer [12](#)
- Sport program
 - automatic transmission with Steptronic [39](#)
 - Driving Dynamic Control [41](#), [42](#)
- Sports seat [29](#)
- Stability control, refer to Dynamic Stability Control DSC [50](#)
- Standing lamps [57](#)
- Starting, engine [36](#)
- Starting, refer to Starting the engine [36](#)
- Starting assistance, refer to Dynamic Stability Control DSC [50](#)
- Starting difficulties
 - jump-starting [97](#)
 - temperature [36](#)
- Starting with a flat battery, refer to Jump-starting [97](#)
- Status at time of printing [5](#)
- Steering lock [36](#)
- Steering wheel [10](#)
 - adjusting [31](#)
- Steptronic, refer to Manual mode [39](#)
- Storage compartments [64](#)
 - electrical fault [64](#)
 - opening manually [64](#)
- Storage nets [64](#)
- Storage space, refer to
 - Luggage compartment [19](#)
 - Storage compartments [64](#)
- Storing desired speeds, refer to Cruise control [44](#)
- Storing seat position, refer to Seat memory [29](#)
- Summer tires, refer to Wheels and tires [78](#)
- Surface ice, refer to Ice warning [48](#)
- Switches, refer to Cockpit [10](#)
- Switch for passenger airbags [33](#)
- Symbols [4](#)

T

- Tachometer [46](#)
- Tail lamps, refer to Rear lamps [93](#)
 - bulb replacement [93](#)
- Tank capacity, refer to Fuel tank capacity [105](#)
- Tank indicator, refer to Fuel gauge [46](#)
- Technical data [102](#)
- Technical modifications, refer to For your own safety [6](#)
- Telephone, refer to the separate Owner's Manual
- Telephone preparation [65](#)
- Temperature
 - air conditioning [59](#)
 - automatic climate control [62](#)
 - engine [46](#)
- Temperature display
 - ice warning [48](#)
 - outside temperature [47](#), [48](#)
 - setting unit of measure [48](#)
- Tempomat, refer to Cruise control [44](#)
- Third brake lamp, refer to Center high-mount brake lamp [93](#)
 - bulb replacement [93](#)
- Three-point seat belt, refer to Safety belts [30](#)
- Tilt alarm sensor
 - deactivating [26](#)
 - remote control [26](#)
- Tire coding [80](#)

Tire inflation pressure
– checking [78](#)
– restoring [78](#)
Tire pressure monitoring,
refer to Flat Tire Monitor [52](#)
Tires
– age [80](#)
– break-in procedures [68](#)
– changing [82](#)
– condition [81](#)
– damage [81](#)
– DOT quality grades [80](#)
– flat [53](#)
– inflation pressure [78](#)
– replacement [82](#)
– Run Flat tires [82](#)
– size [78](#)
– storage [83](#)
– temperature [81](#)
– traction [80](#)
– tread [81](#)
– tread wear [80](#)
– tread wear indicators, refer
to Tire tread, Wheel/tire
damage [81](#)
– Uniform Tire Quality
Grading [80](#)
– winter tires [82](#)
Tire storage [83](#)
Tool kit, refer to Onboard tool
kit [91](#)
Torque, refer to Engine
data [102](#)
Tow bar [99](#)
Towing [98](#)
– with sequential manual
gearbox SMG [99](#)
Towing eyelets [98](#)
Towing the vehicle [98](#)
– with automatic
transmission [99](#)
– with the front axle raised [99](#)
Tow rope [99](#)
Tow sockets for towing
eyelet [98](#)
Tow-starting [98](#), [99](#)
Track width, refer to
Dimensions [104](#)

Traction control, refer to
Dynamic Stability Control
DSC [50](#)
Transmission
– automatic transmission with
Steptronic [38](#)
– manual transmission [38](#)
– sequential manual gearbox
SMG [40](#)
Transmission detent, refer to
Range selection [38](#)
Transmission malfunction,
refer to Malfunction [39](#)
Transporting children
safely [33](#)
Transport securing device,
refer to Cargo loading [71](#)
Tread depth, refer to Tire
tread [81](#)
Tread wear indicators
in the tires, refer to
Tire tread, Wheel/tire
damage [81](#)
Trip distance recorder, refer to
Trip odometer [46](#)
Trip meter, refer to Trip
odometer [46](#)
Trip odometer [46](#)
Trunk
– refer to Luggage
compartment [19](#)
Trunk lid
– opening via remote
control [17](#)
– refer to Luggage
compartment lid [18](#)
Trunk lid, refer to Luggage
compartment lid [18](#)
Trunk volume, refer to
Luggage compartment
capacity [103](#)
Turning circle, refer to
Dimensions [104](#)
Turn signal indicators [42](#)
– indicator lamp [13](#)

Turn signal indicators, bulb
replacement
– front [93](#)
– rear [93](#)
– side [93](#)
TV function, refer to Owner's
Manual for Onboard
Computer

U

Undercoating, refer to the
Caring for your vehicle
brochure
Units
– average
consumption [48](#)
– average
speed [48](#)
– temperature [48](#)
Unlocking
– from inside [18](#)
– from outside [16](#)
Used batteries, refer to
Battery disposal [95](#)

V

Vehicle
– battery [94](#)
– breaking in [68](#)
– care, refer to the Caring for
your vehicle brochure
– cargo loading [70](#)
– cleaning the rear window,
refer to the Caring for your
vehicle brochure
– engine [37](#)
– leaving the vehicle [37](#)
– measurements, refer to
Dimensions [104](#)
– parked [70](#)
– storage, refer to the Caring
for your vehicle brochure
– washing, refer to the Caring
for your vehicle brochure
– weight [103](#)
Vehicle battery [94](#)
Vehicle Memory [31](#)

- Ventilation [59](#), [63](#)
 - air conditioning [59](#)
 - automatic climate control [63](#)
- Vents, refer to
 - Ventilation [59](#), [63](#)
- Volume
 - fuel tank, refer to
 - Capacities [105](#)

W

- Warning and indicator lamps [12](#)
- Warning triangle [96](#)
- Warranty, refer to Service and Warranty Information
 - Booklet for US models, Warranty and Service Guide
 - Booklet for Canadian models [89](#)
- Warranty and service [7](#)
- Washer/wiper system [43](#)
- Washer fluid reservoir, refer to
 - Capacities [105](#)
 - Headlamp washer system and Windshield washer system [86](#)
- Washer jets, refer to
 - Windshield washer nozzles [44](#)
- Washing fluids [86](#)
- Washing systems [86](#)
- Waste tray, refer to Ashtray [65](#)
- Water on roads, flooding [69](#)
- Weights [103](#)
- Wheel/tire combinations [82](#)
- Wheelbase, refer to
 - Dimensions [104](#)
- Wheels and tires [78](#)
- Width, refer to
 - Dimensions [104](#)
- Wind deflector [24](#)
- Window defrosting, refer to
 - Defrosting windows
 - air conditioning [60](#)
 - automatic climate control [62](#)
- Windows
 - convenience operation [18](#)
- Windshield washer nozzles [44](#)
- Windshield washer reservoir [86](#)
 - volume, refer to Capacities [105](#)
- Windshield washer system
 - washer/wiper system [43](#)
 - washing fluids [86](#)
- Windshield wiper blades
 - care, refer to the Caring for your vehicle brochure
 - changing [91](#)
- Windshield wipers
 - changing [91](#)
 - refer to Washer/wiper system [43](#)
- Winter tires [82](#)
 - changing [94](#)
 - condition [81](#)
 - storage [83](#)
- Wood decoration, refer to the Caring for your vehicle brochure
- Work in the engine compartment [84](#)
- Wrench, refer to Onboard tool kit [91](#)

X

- Xenon lamps, bulb replacement [92](#)

Refueling

So that you have important specifications available to you when you stop to refuel, we recommend that you fill out this table with the data that apply to your vehicle. Consult the index for individual specifications.

Fuel

Designation

Please enter your preferred fuel here.

Engine oil

Quality

The oil volume between the two marks on the oil dipstick corresponds to approx. 1.1 US quarts/1 liter.

Tire inflation pressures

	Summer tires Front	Rear	Winter tires Front	Rear
Up to 2 persons				
2 persons plus luggage				

More about BMW

bmwusa.com



The Ultimate
Driving Machine

01 41 0 158 704 ue

