

**BMW 2006 3 Series
Convertible**



325Ci
330Ci

**The Ultimate
Driving Machine®**





The fun-seeking, freedom-loving 2006 BMW 3 Series Convertible. Your wish has come **true.**

Graded on a curve, the 3 Series Convertible gets **Straight A's.** (On straightaways, too.)



Enjoy the GPS navigation system.





The fun
starts here.

Equipment | Exterior



■ **Halogen free-form foglights** are cleanly integrated into the front bumper, illuminating the road ahead in bad weather.



■ **Side protection strips** shield against parking lot “dings,” while providing a subtle character line. (Styling 119 wheels shown are available with optional 325Ci Sport Package.)



■ **Adaptive Brake Lights** increase the 3 Series Convertible's visibility by signaling the intensity of your braking action.

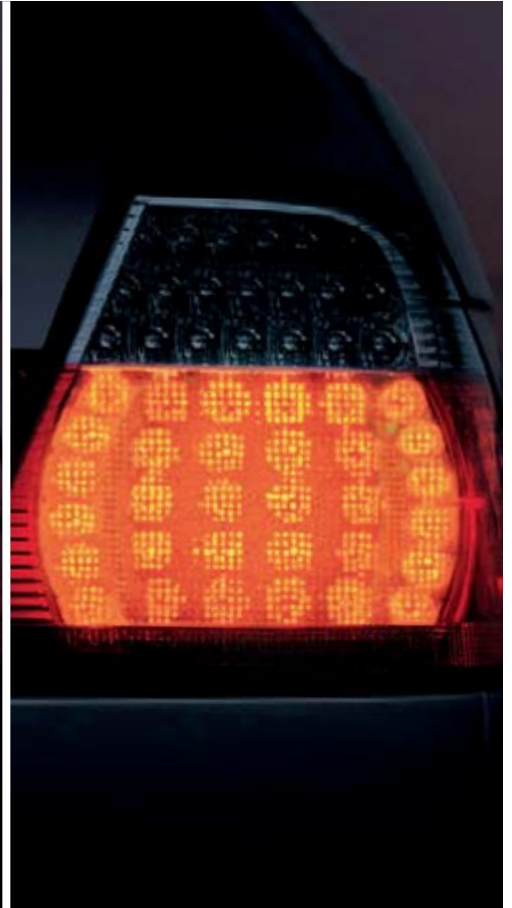

■ **Chrome rocker panel strips** help protect paint from scuffs and chips.



■ The 325Ci with **16 x 7.0 Star Spoke (Styling 169)** alloy wheels, and 205/55R-16 all-season tires.



■ The 330Ci with **17 x 7.0 Double Spoke (Styling 98)** alloy wheels, and 205/50R-17 all-season tires.

■ Standard

Interior | Equipment



■ **Rain sensor** uses infrared light to measure the amount of rain. When the wipers are in the “intermittent” mode, the rain sensor automatically adjusts the windshield wiping interval as needed. **Automatic headlight control** (included with rain sensor but not shown), activates the headlights by means of a sensor that responds to darkness.



■ Ingenious **seatback easy-entry feature** offers power fore/aft controls that may be used to move the seat forward all the way for easy access, then back again to the seat’s original position. Each front seat has two sets of fore/aft controls – the controls on top move the seat double-speed, for quickest access.



■ **Seat-integrated front safety belts** help keep occupants firmly and comfortably in place. The seat-integrated design also helps ease entry and exit for rear-seat passengers.



■ **Three-point safety belts** at both rear seating positions hold occupants comfortably and safely in place.



■ **Rear headrests** help protect the heads and necks of rear-seat occupants in an impact or sudden stop. BMW’s Rollover Protection System bars are discreetly integrated for additional safety, in case of rollover.



■ **Power front seats** include a **driver’s seat and mirror memory system**, which lets up to three drivers set their preferred seat and exterior mirror positions. (Plus, the passenger’s-side mirror tilts down when vehicle is shifted into reverse gear.) (Lumbar support shown standard in 330Ci; included in 325Ci Premium Package.)



■ A **three-spoke leather-wrapped multi-function sport steering wheel** lets you keep both hands on the wheel while adjusting audio settings, cruise control and using the accessory phone. (Optional navigation system shown.)



■ The 325Ci **five-speed manual transmission** includes a direct-drive fifth gear and provides crisp shifting. (Optional navigation system shown.)



■ The close shift pattern of the **six-speed manual transmission**, standard in the 330Ci, delivers a precise, athletic feel for a more dynamic driving experience. (330Ci only) (5-speed manual available in the 325Ci.)

Equipment | Packages

The 330Ci Performance Package is a product of BMW Individual – the division responsible for creating unique, limited-edition BMWs. It includes a more muscular engine that boasts 235 hp at 5900 rpm, and 222 lb-ft of torque at just 3500 rpm. To make the most of this extra power, the redline has been increased from 6500 to 6800 rpm. Additional, distinctive exterior and interior features further differentiate the Performance Package from all other 3 Series models.



Front air dam that is unique to the Performance Package displays a face that's all business.



The **rear apron**, with its integrated diffuser, upgrades the car's aerodynamics.



Thanks to modifications by driving enthusiast engineers at BMW, the **330Ci Performance Package** brings track-inspired excitement to your daily drive. The suspension is even lower, stiffer and firmer than in the standard 330Ci Convertible. For greater adhesion, wheel camber is set at -0.5° , which results in a larger tire contact patch when cornering quickly. The bold look of the 18" M Double Spoke (Styling 135M) alloy wheels and performance tires – 225/40 front, 255/35 rear – emphasize the feeling that these wheels can deliver higher cornering speeds with confidence.

Packages | Equipment



M three-spoke leather-wrapped multi-function sport steering wheel has fingertip cruise, audio and telephone¹ controls.

¹If so equipped.



Sport seats upholstered in Alcantara/cloth, a no-cost option, provide optimum lateral support while adding a dynamic, custom touch. Montana leather is also available for those who prefer the look and feel of all-leather upholstery.



























































































































Aluminum Black Cube interior trim: The black aluminum cube interior trim makes for a more sporty, high-tech interior. Silver Cube interior trim, a no-cost option, is also available.



Clean lines, throaty sound. The exhaust has been specially tuned to emit a distinctly more assertive sound than the standard 3 Series Convertible. This lusty growl is conducted through two handsome 35mm exhaust tips, which are set into a sleek, rear apron.

Combinations

Materials	Leatherette ¹		Montana Leather ²				Alcantara/Cloth ³
	Sand	Black	Sand	Natural Brown ⁴	Gray	Black	
Interior/Upholstery Colors							
Exterior Colors							
300 Alpine White ⁵							
438 Electric Red ^{5,6}							NA
405 Imola Red ⁷	NA	NA					
668 Jet Black ⁵							
354 Titanium Silver Metallic ⁸							
A08 Silver Gray Metallic ⁸							
A22 Sparkling Graphite Metallic ⁸							
A18 Quartz Blue Metallic ^{6,8}							NA
A07 Mystic Blue Metallic ⁸							
A35 Monaco Blue Metallic ⁸							
A23 Sonora Metallic ^{6,8}							NA
A43 Deep Green Metallic ^{6,8}							NA
475 Black Sapphire Metallic ⁸							
Interior Trims							
Myrtle Wood ⁹							
Aluminum Brushed Columns ¹⁰							
Black Cube ¹¹							
Silver Cube ¹²							

¹ Leatherette upholstery: Standard in 325Ci. Not available in 330Ci.

² Montana Leather upholstery: Standard in 330Ci and 330Ci with Performance Package. Optional in 325Ci.

³ Cloth/Alcantara upholstery: No-cost option with 330Ci Performance Package. (Exclusive to 330Ci Performance Package)

⁴ Natural Brown Montana Leather upholstery: Includes Black Leather details.

⁵ Non-metallic exterior paint: Standard on 325Ci and 330Ci.

⁶ Electric Red non-metallic, Quartz Blue Metallic, Sonora Metallic and Deep Green Metallic exterior paint: Not available with 330Ci Performance Package.

⁷ Imola Red non-metallic exterior paint: Exclusive to 330Ci Performance Package.

⁸ Metallic exterior paint: Optional on 325Ci and 330Ci.



⁹ Myrtle Wood interior trim: Standard in 325Ci and 330Ci. Not available with 330Ci Performance Package.

¹⁰ Aluminum Brushed Columns interior trim: No-cost option. Not available with 330Ci Performance Package.

¹¹ Black Cube interior trim: Exclusive to and standard with 330Ci Performance Package.

¹² Silver Cube interior trim: Exclusive to and a no-cost option with 330Ci Performance Package.

Available softtop colors

-  388 Black
-  391 Dark Blue

The pages in this section of the brochure show available colors and materials for the BMW 3 Series Convertible. Use these samples to compare paint, upholstery and trim colors and combinations. Please note that these samples are representations; they are not exact reproductions. To see the actual colors, visit your local BMW center. They will be happy to show you original samples and assist you with special requests.

Standard Equipment | Optional Equipment

All vehicle specifications contained in this document are based on the latest product information available at the time of printing. BMW reserves the right to make changes, without notice, in colors, materials, equipment, specifications and models. Further information can be obtained from your authorized BMW center or bmwusa.com.

Performance and efficiency	325Ci	330Ci	Exterior	325Ci	330Ci
2.5-liter dual overhead cam (DOHC), 24-valve inline 184-horsepower 6-cylinder engine	●		Retractable, high-intensity headlight washers	★	★
3.0-liter dual overhead cam (DOHC), 24-valve inline 225 ¹ -horsepower 6-cylinder engine		●	Heated dual power mirrors and heated windshield washer jets	●	●
Electronic throttle control	●	●	Fully lined fabric power softtop with glass rear window and electric rear-window defroster	●	●
Double-VANOS "steplessly" variable valve timing	●	●	Body-color hardtop with integrated rear-window defroster, retractable coat hooks, and reading lights front and rear	○	○
Dual resonance intake system	●	●	Black-finish trim on headlight panels and front bumper air inlet	●	●
5-speed manual transmission	●		Metallic paint	○	○
6-speed manual transmission		●	Matte, stainless steel, 35mm dual exhaust pipes		■
5-speed STEPTRONIC automatic transmission with Adaptive Transmission Control	○	○			
Handling, ride and braking			Interior		
Dynamic Stability Control (DSC) with All Season Traction	●	●	10-way power front seats (includes 2-way headrests)	●	●
Strut-type front suspension with forged-aluminum lower arms	●	●	10-way power (includes 2-way headrests) front sport seats with 2-way manual thigh support	□	□/■
Multi-link rear suspension with cast-aluminum upper transverse arms	●	●	3-driver memory for exterior mirror and seat positions; automatic tilt-down of passenger's side-view mirror when vehicle is shifted into reverse gear	●	●
Front and rear anti-roll (stabilizer) bars	●	●	4-way power lumbar support for front seats	◇	●
Twin-tube gas-pressure shock absorbers	●	●	Seatback easy-entry feature with memory and 2x-speed power fore-aft control	●	●
Engine-speed-sensitive, variable-assist power steering	●	●	3-stage heated front seats	○/★	○/★
4-wheel ventilated anti-lock disc brakes with Dynamic Brake Control	●	●	3-spoke leather-wrapped multi-function sport steering wheel with fingertip cruise, audio and telephone ⁷ controls	●	●
Sport suspension calibration	□	□/■ ²	M 3-spoke leather-wrapped multi-function sport steering wheel with fingertip cruise, audio and telephone ⁷ controls		■
Exterior			Audio system		
16x7.0 Star Spoke (Styling 169) alloy wheels, 205/55R-16 all-season tires	●		Anti-theft AM/FM stereo/CD/MP3 audio system with 10 speakers, Radio Data System (RDS), and Auto-Store; pre-wired for 6-disc CD changer ⁸ and compatible with auxiliary audio input adaptor ⁸ for audio connection of portable music players	●	
17x7.0 Double Spoke (Styling 98) alloy wheels, 205/50R-17 all-season tires		●	Harman Kardon AM/FM stereo/CD/MP3 audio system with 11 upgraded speakers (including subwoofer), upgraded amplification, and vehicle-speed-sensitive equalization; pre-wired for 6-disc CD changer ⁸ and compatible with auxiliary audio input adaptor ⁸ for audio connection of portable music players	○	●
17x7.0 Double Spoke (Styling 98) alloy wheels, 205/50R-17 run-flat all-season tires ^{3,4}		○			
17x8.0 Five Spoke (Styling 119) alloy wheels, 225/45R-17 performance tires ⁵	□		Instrumentation and controls		
M Double Spoke (Styling 68M) alloy wheels, 17x7.5 front, 17x8.5 rear; 225/45R-17 front, 245/40R-17 rear performance tires ⁵		□	Service Interval Indicator with miles-to-service readout	●	●
Double Spoke Composite (Styling 71) alloy wheels, 18x8.0 front, 18x8.5 rear; 225/40R-18 front, 255/35R-18 rear performance tires ⁵		○ ⁶	Check Control vehicle monitor system with pictogram display	●	●
M Double Spoke (Styling 135M) alloy wheels, 18x8.0 front, 18x8.5 rear; 225/40R-18 front, 255/35R-18 rear performance tires ⁵		■	4-function on-board computer	●	●
Flat Tire Warning Indicator	●	●	On-board navigation system with 16:9 screen and high-function on-board computer	○	○
Space-saver spare wheel and tire	●	●	Titanium-finish instrument rings		●
Aerodynamic package		■	Tachometer with 300 rpm-higher redline and red needles		■
Chrome ³ and body-color detail trim	●	●	Short, sport gearshift lever		■
White turn-signal indicators	●	●			
Xenon Adaptive Headlights with auto-leveling	○	○			
Halogen free-form foglights	●	●			

- Standard equipment
- Optional equipment
- ◇ Premium Package
- Sport Package
- Included in opt. 330Ci Performance Package
- ★ Cold Weather Package
- △ BMW center-installed accessory

- 1 330Ci with Performance Package: 235 horsepower.
- 2 Sport suspension is tuned more aggressively on 330Ci with Performance Package.
- 3 Not available with 330Ci Performance Package.
- 4 Not available with Sport Package.
- 5 Due to low-profile tires, please note: wheels, tires and suspension parts are more susceptible to road hazard and consequential damages. Performance tires not recommended for driving in ice and snow.
- 6 Sport Package required. Not available with 330Ci Performance Package.
- 7 If so equipped.
- 8 Available as an accessory.

Optional Equipment | Standard Equipment

Comfort and convenience	325Ci	330Ci	BMW Maintenance Program	325Ci	330Ci
Vehicle & Key Memory	●	●	BMW Maintenance ¹⁰	●	●
Remote entry, including 2-step unlocking and remote trunk release	●	●	Premium Package		
Automatic climate control with micro-filter and air recirculation	●	●	Automatic-dimming inside rear-view mirror	◇	●
Tilt/telescopic steering wheel column	●	●	BMW Universal Transceiver (integrated garage-door opener)	◇	●
Park Distance Control (PDC), rear	○	○	BMW Assist (Telematics) with Bluetooth wireless technology for hands-free calling with Bluetooth cellular phones ⁹	◇	○
Automatic-dimming inside rear-view mirror	◇	●	4-way power lumbar support for front seats	◇	●
Power front and rear windows with “one-touch” down operation, driver window “one-touch” up	●	●	Sport Package^{3, 11}		
One-button lowering and raising of all windows	●	●	Sport suspension calibration	□	□
Cruise control	●	●	10-way power (includes 2-way headrests) front sport seats with 2-way manual thigh support	□	□
Front map-reading and footwell lights	●	●	17 x 8.0 Five Spoke (Styling 119) alloy wheels, 225/45R-17 performance tires ⁵	□ ⁶	
Locking glovebox with rechargeable take-out flashlight	●	●	M Double Spoke (Styling 68M) alloy wheels, 17 x 7.5 front, 17 x 8.5 rear; 225/45R-17 front, 245/40R-17 rear performance tires ⁵		□ ⁶
Fully automatic softtop	●	●	Double Spoke Composite (Styling 71) alloy wheels, 18 x 8.0 front, 18 x 8.5 rear; 225/40R-18 front, 255/35R-18 rear performance tires ⁵		○ ⁶
BMW Universal Transceiver (remote garage-door opener)	◇	●	Cold Weather Package		
Electric interior trunk release	●	●	Ski bag	★	★
Expandable cargo space with top raised	●	●	3-stage heated front seats	★	★
Fully finished trunk with drop-down tool kit	●	●	Retractable, high-intensity headlight washers	★	★
Rain-sensing windshield wipers and automatic headlight control	●	●	Performance Package		
BMW Ambient Lighting	●	●	235-horsepower engine		■
Pre-wiring for cellular phone, alarm, garage-door opener, 6-disc CD changer and auxiliary input	●	●	More aggressively tuned sport suspension		■
Safety and security			10-way power (includes 2-way headrests) front sport seats with 2-way manual thigh support		■
Anti-lock braking system (ABS)	●	●	Montana leather upholstery		■
Adaptive Brake Lights	●	●	Alcantara/cloth upholstery ¹²		○ ¹³
Driver's and passenger's front airbag supplemental restraint system (SRS) with “smart” dual-threshold, dual-stage deployment and sensor to help prevent unnecessary passenger's airbag deployment	●	●	M 3-spoke leather-wrapped multi-function sport steering wheel with fingertip cruise, audio and phone ⁷ controls		■
Front door-mounted side-impact airbags	●	●	M Double Spoke (Styling 135M) alloy wheels, 18x8.0 front, 18 x 8.5 rear; 225/40R-18 front, 255/35R-18 rear performance tires ⁵		■
Rear side-impact airbags	○	○	Aerodynamic package		■
Rollover Protection System	●	●	Tachometer with 300 rpm-higher redline and red needles		■
Interlocking door anchoring system to help protect against door intrusion in side impacts	●	●	Short, sport gearshift lever		■
BMW Assist (Telematics) with Bluetooth® wireless technology for hands-free calling with Bluetooth cellular phones ⁹	○/◇	○	Matte stainless steel, 35mm dual exhaust pipes		■
Battery Safety Terminal with automatic fuel cut-off triggered by airbag deployment, crash sensor that automatically turns on hazard lights and interior lights, and unlocks doors	●	●	Aluminum “Black Cube” interior trim		■
Central locking system (including glovebox door) with center console switch (leaves gas filler door unlocked), double-lock feature and 2-step unlocking	●	●	Aluminum “Silver Cube” interior trim ¹²		○ ¹³
Coded Driveaway Protection	●	●	Accessories¹⁴		
Seat-integrated front safety belts with automatic tensioners and force limiters	●	●	iPod Seamless Integration System	△	△
Automatic-locking retractors (ALR) on all passenger safety belts for installation of child restraint seats	●	●	SIRIUS satellite radio	△	△
Daytime running lights (via Vehicle Memory system – programmed at BMW center)	●	●			
LATCH attachments on child-restraint safety installation	●	●			

9 See your authorized BMW center for rules and regulations on subscription required with BMW Assist.

10 BMW Maintenance Program covers all factory-recommended maintenance on all new MY 2004 and later BMW vehicles, as determined by the Service Interval Indicator, for 4 years or 50,000 miles, whichever comes first. Exclusions from coverage: gasoline, gasoline additives, windshield washer fluids and additives, lights, tires, wheels, wheel alignment, tire balancing and rotation. All work must be performed by an authorized BMW center. See the Service and Warranty Information booklet for more specific terms, conditions and limitations. Further information can be obtained from your local authorized BMW center.

11 325Ci Sport Package requires leather upholstery.

12 No-cost option with 330Ci Performance Package.

13 Requires 330Ci Performance Package.

14 For additional information, please visit your authorized BMW center.

Technical | Data

Weight		325Ci	330Ci
Unladen weight	lbs	3560 (3627)	3616 (3704)
Weight distribution, front/rear			
Manual transmission	%	48.9/51.1	48.7/51.3
Automatic transmission	%	49.2/50.8	49.4/50.6

Engine		325Ci	330Ci
Liters/type		2.5/inline 6	3.0/inline 6
Bore/stroke	inch	3.31/2.95	3.31/3.53
Nominal output/rpm	hp	184/6000	225/5900
Max. torque/rpm	lb-ft	175/3500	214/3500
Compression ratio	:1	10.5	10.2
Fuel grade		Unleaded prem.	Unleaded prem.

Transmission		325Ci	330Ci
Gear ratios – 5-speed manual transmission			
I/II	:1	4.23/2.52	
III/IV	:1	1.66/1.22	
V/R	:1	1.00/4.04	
Final drive ratio	:1	3.46	
Gear ratios – 6-speed manual transmission			
I/II	:1		4.35/2.50
III/IV	:1		1.66/1.23
V/VI/R	:1		1.0/0.85/3.93
Final drive ratio	:1		3.07
Gear ratios – 5-speed Automatic transmission			
I/II	:1	3.45/2.21	3.45/2.21
III/IV	:1	1.59/1.00	1.59/1.00
V/R	:1	0.76/3.17	0.76/3.17
Final drive ratio	:1	3.46	3.38

Performance		325Ci	330Ci
Drag coefficient	C _d	0.35	0.35
Top speed ¹	mph	128	128 [155]
Acceleration – 0-60 ²	sec	7.7 (8.9)	6.9 (7.5)

Fuel Consumption ³		325Ci	330Ci
Manual transmission			
City/Highway	mpg	19/27 ⁴	19/28 ⁵
Automatic transmission			
City/Highway	mpg	18/26	18/25

Tires, wheels and brakes		325Ci	330Ci
Tire dimensions – standard ⁶		205/55R-16	205/50R-17
		All-season	All-season
Wheel dimensions – standard		16x7.0	17x7.0
Material		Cast alloy	Cast alloy
Brake dimensions		diameter	
Front – vented	inch	11.8	12.8
Rear – vented	inch	11.6	12.6

Figures in () apply to vehicles with automatic transmission. Figure in [] applies to vehicles with 330Ci Performance Package.

1 Top speed limited electronically.

2 BMW AG test results: Actual acceleration results may vary depending on specification of vehicle, road and environmental conditions, testing procedures and driving style. These results should be used for comparison only and verification should not be attempted on public roads. **BMW urges you to obey all posted speed laws and always wear safety belts.**

3 EPA est. mpg, city/highway. Your actual mileage will vary, depending upon speed, driving habits, trip length and driving conditions; actual mileage will most likely be lower.

4 5-speed manual transmission.

5 6-speed manual transmission.

6 Sport Packages and 330Ci Performance Package: Due to low-profile tires, please note: wheels, tires and suspension parts are more susceptible to road hazard and consequential damages. Performance tires not recommended for driving in ice and snow.

Technical | Data

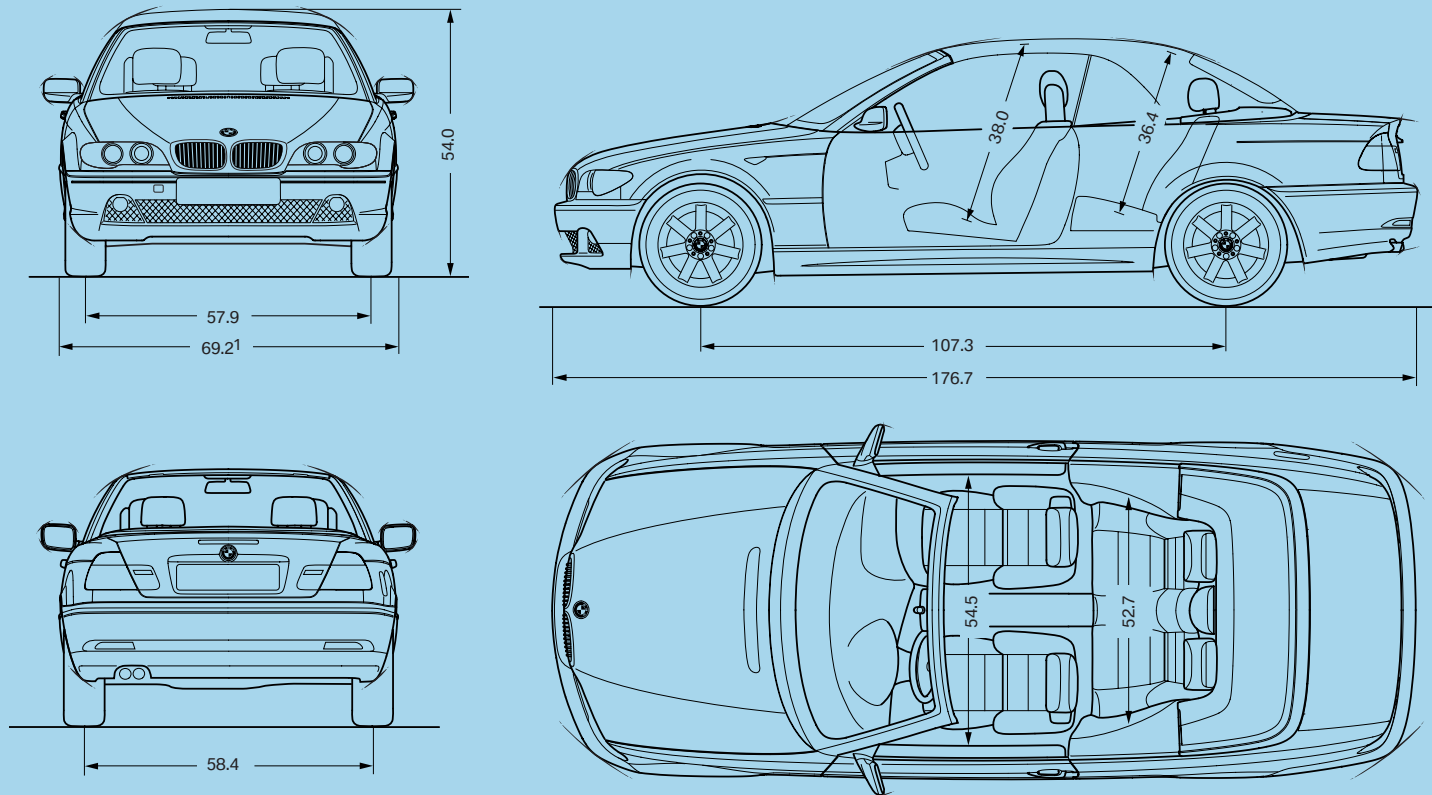

¹ Excluding side-view mirrors; total width including side-view mirrors is 76.7 inches.

Illustrations above:
All dimensions in inches. Dimensions shown in illustration not representative of 330Ci with Performance Package.

All illustrations and specifications contained in this brochure are based on the latest product information available at the time of printing. BMW reserves the right to make changes at any time, without notice, in colors, materials, equipment, specifications and models. BMW may, subject to legal requirements, determine the Model Year designation of its vehicles. The Model Year designation on any particular model may be longer or shorter than 12 months. Some vehicles pictured may contain non-U.S. equipment. Some models may be shown with optional equipment. While BMW NA makes all reasonable efforts to provide accurate information in this brochure, there is no guarantee or warranty of accuracy. Furthermore, we do not assume any liability for the accuracy or completeness of information presented. This brochure shall not be used or relied upon as a substitute for information that is available from your BMW center. Further information can be obtained from your authorized BMW center or bmwusa.com.

U.S. Importer: BMW of North America, LLC, Woodcliff Lake, NJ 07677. All illustrations and specifications contained in this brochure are based on the latest product information available at the time of printing. BMW reserves the right to make changes at any time, without notice, in colors, materials,

equipment, specifications and models. BMW may, subject to legal requirements, determine the Model Year designation of its vehicles. The Model Year designation on any particular model may be longer or shorter than 12 months. Some vehicles pictured may contain non-U.S. equipment. Some models may be shown with optional equipment. While BMW NA makes diligent efforts to provide accurate information in this brochure, there is no guarantee or warranty of accuracy. Furthermore, we do not assume any liability for the accuracy or completeness of information presented. This brochure shall not be used or relied upon as a substitute for information that is available from your BMW center. Further information can be obtained from your authorized BMW center or bmwusa.com.

©2006 BMW of North America, LLC. Not to be reproduced wholly or in part without written permission of BMW NA. The BMW name and logo are registered trademarks.

The Bluetooth word mark and logos are owned by the Bluetooth SIG, Inc. and any use of such marks by BMW is under license. Other trademarks and trade names are those of their respective owners.

BMW recommends 