

Owner's Manual
for Vehicle



The Ultimate
Driving Machine



325Ci
330Ci

Congratulations, and thank you for choosing a BMW.

Thorough familiarity with your vehicle will provide you with enhanced control and security when you drive it. Therefore, we have one request:

Please take the time to read this Owner's Manual and familiarize yourself with the information that we have compiled for you before starting off in your new BMW. The manual contains important data and instructions intended to assist you in obtaining maximum satisfaction from your BMW's unique array of advanced technical features. It also contains information on vehicle maintenance designed to enhance operating safety while simultaneously helping you to maintain your BMW's value throughout an extended service life. For additional information refer to the supplemental manuals.

This Owner's Manual should be considered a permanent part of this vehicle. It should stay with the vehicle when sold to provide the next owner with important operating, safety and maintenance information.

We wish you an enjoyable driving experience.

BMW AG

4 Notes

About this Owner's Manual

We have made every effort to ensure that you are able to find what you need in this Owner's Manual as quickly as possible. The fastest way to find certain topics is by using the detailed index at the end. If you wish to gain an initial overview of your vehicle, you will find this in the first chapter.

Should you wish to sell your BMW at some time in the future, please remember to hand over this Owner's Manual to the new owner; it is an important part of the vehicle.

© 2004 Bayerische Motoren Werke
Aktiengesellschaft
Munich, Germany

Reprinting, including excerpts, only with the
written consent of BMW AG, Munich.

Order No. 01 41 0 158 112

US English II/04

Printed in Germany

Printed on environmentally friendly paper,
bleached without chlorine, suitable for recycling.

Additional sources of information

If you have any additional questions, your BMW center will be glad to advise you.

You can find more information about BMW, for example on its technology, on the Internet at www.bmw.com.

Symbols used



Indicates precautions that must be followed precisely in order to avoid the possibility of personal injury and serious damage to the vehicle.



Indicates information that will assist you in gaining the optimum benefit from your vehicle and enable you to care more effectively for your vehicle.



Refers to measures that can be taken to help protect the environment.

◀ Marks the end of a specific item of information.

* Indicates special equipment, country-specific equipment and optional extras when available.



Vehicle Memory, Key Memory, refer to page 58. Identifies functions that can be specifically adapted for a particular key or vehicle. These adjustments can be performed by your BMW center.



Indicates that you should consult the relevant section of this Owner's Manual for information on a particular part or assembly.

Notes

Your individual vehicle

On purchasing your BMW, you have decided in favor of a model with individualized equipment and features. This Owner's Manual describes all models and equipment that BMW offers within the same group.

We hope you will understand that equipment and features are included that you might not have chosen for your vehicle. You can easily identify any differences with the aid of the asterisk * used to identify all optional equipment and accessories.

If your BMW features equipment such as a car radio or telephone, which is not described in this Owner's Manual, Supplementary Owner's Manuals are enclosed. We ask you to read these manuals as well.

Status at time of printing

BMW pursues a policy of continuous, ongoing development that is conceived to ensure that our vehicles continue to embody the highest quality and safety standards combined with advanced, state-of-the-art technology. For this reason, the features described in this Owner's Manual could differ from those in your vehicle. Nor can errors and omissions be entirely ruled out. You are therefore asked to appreciate that no claims can be recognized on the basis of the data, illustrations or descriptions in this Owner's Manual.

For your own safety

Maintenance and repair



Advanced technology, e.g. the use of modern materials and high-performance electronics, requires specially adapted maintenance and repair methods. Therefore, only have corresponding work on your BMW carried out by a BMW center or a workshop that works according to BMW repair procedures with correspondingly trained personnel. If work is carried out improperly there is a danger of consequential damage and the related safety risks. ◀

Parts and accessories



Important safety information!

For your own safety, use genuine parts and accessories approved by BMW.

When you purchase accessories tested and approved by BMW and Original BMW Parts, you simultaneously acquire the assurance that they have been thoroughly tested by BMW to ensure optimum performance when installed on your vehicle.

BMW warrants these parts to be free from defects in material and workmanship.

BMW will not accept any liability for damage resulting from installation of parts and accessories not approved by BMW.

BMW cannot test every product made by other manufacturers to ascertain whether it can be used on a BMW safely and without risk to either the vehicle, its operation, or its occupants.

Original BMW Parts, BMW Accessories and other products approved by BMW, together with professional advice on using these items, are available from all BMW centers.

Installation and operation of non-BMW approved accessories such as alarms, radios, amplifiers, radar detectors,

wheels, suspension components, brake dust shields, telephones – including operation of any portable cellular phone from within the vehicle without using an externally mounted antenna – or transceiver equipment such as a CB, walkie-talkie, ham radio or similar, may cause extensive damage to the vehicle, compromise its safety, interfere with the vehicle's electrical system or affect the validity of the BMW Limited Warranty. Contact your BMW center for additional information.

Do not use key or remote control to lock doors or luggage compartment with anyone inside the vehicle. Refer to the Owner's Manual for more details. ◀



Maintenance, replacement, or repair of the emission control devices and systems may be performed by any automotive repair establishment or individual using any certified automotive part. ◀

Service and warranty

This manual is supplemented by a Service and Warranty Information Booklet for US models or a Warranty and Service Guide Booklet for Canadian models.

We recommend that you read this publication thoroughly.

Your BMW is covered by the following warranties:

- ▷ New Vehicle Limited Warranty
- ▷ Rust Perforation Limited Warranty
- ▷ Federal Emissions System Defect Warranty
- ▷ Federal Emissions Performance Warranty
- ▷ California Emission Control System Limited Warranty.

Detailed information about these warranties is listed in the Service and Warranty Information Booklet for US models or in the Warranty and Service Guide Booklet for Canadian models.

Notes

Reporting safety defects

The following only applies to vehicles owned and operated in the US.

If you believe that your vehicle has a defect which could cause a crash or could cause injury or death, you should immediately inform the National Highway Traffic Safety Administration NHTSA in addition to notifying BMW of North America, LLC, P.O. Box 1227, Westwood, New Jersey 07675-1227, telephone toll-free 1-800-831-1117.

If NHTSA receives similar complaints, it may open an investigation, and if it finds that a safety defect exists in a group of vehicles, it may order a recall and remedy campaign. However, NHTSA cannot become involved in individual problems between you, your dealer, or BMW of North America, LLC.

To contact NHTSA, you may either call the Auto Safety Hotline toll-free at 1-800-424-9393 or 366-0123 in the Washington, D.C. area, or write to: NHTSA, U.S. Department of Transportation, Washington, D.C. 20590. You can also obtain other information about motor vehicle safety from the Hotline.

Contents

Notes	About this Owner's Manual	4
	Additional sources of information	4
	Symbols used	4
	Your individual vehicle	5
	Status at time of printing	5
	For your own safety	5
	Service and warranty	6
Reporting safety defects	7	

Overview	Cockpit	14
	Instrument cluster	16
	Indicator and warning lamps	18
	Buttons in steering wheel*	21
	Hazard warning triangle*	22
	First-aid kit*	22
	Refueling	23
Fuel specifications	24	

Controls and features	Opening and closing:	
	Keys	28
	Central locking system	28
	Opening and closing – via the remote control	29
	Opening and closing – via the door lock	31
	Opening and closing – from the inside	32
	Luggage compartment lid	33
	Luggage compartment	35
	Alarm system*	36
	Electric power windows	38
	Glass sunroof, electric*	39
	Adjustments:	
	Safe seating position	41
	Seats	42
Manual seat adjustment	42	
Power seat adjustment*	44	
Lumbar support*	44	
Head restraints	45	
Entering the rear	45	
Safety belts	46	
Seat and mirror memory*	47	
Seat heating*	48	
Mirrors	49	
Steering wheel	50	

Contents

Controls and features	Passenger safety systems:	Technology for safety and driving convenience:	Loading and transporting:
	Airbags 51	Park Distance Control (PDC)* 80	Through-loading system 104
	Transporting children safely 54	Dynamic Stability Control (DSC) 81	Ski bag* 105
	Vehicle Memory, Key Memory 58	Flat Tire Monitor* 82	Cargo loading 106
	Driving:	Brake force display 84	Roof-mounted luggage rack* 109
	Ignition lock 59	Lamps:	
	Starting the engine 59	Parking lamps/Low beams 85	
	Switching off the engine 61	Adaptive headlights* 86	
	Parking brake 61	Instrument lighting 86	
	Manual transmission 62	High beams/Standing lamps 87	
	Sequential manual gearbox SMG* 63	Front fog lamps 87	
	Automatic transmission with Steptronic* 67	Interior lamps 88	
	Turn signal indicator/Headlamp flasher 70	Controlling the climate for pleasant driving:	
	Washer/wiper system/Rain sensor* 71	Air conditioning 90	
	Cruise control* 72	Automatic climate control* 94	
Everything under control:	Roller sun blind* 98		
Odometer 74	Interior conveniences:		
Tachometer 74	Premium sound system* 99		
Energy control 74	Glove compartment 99		
Fuel gauge 75	Storage compartments 100		
Engine coolant temperature gauge 75	Microphone* 101		
Service interval display 76	Ashtray, front* 102		
Check Control 76	Ashtray, rear* 102		
Clock 77	Clothes hooks 103		
Computer 78			

Contents

Operation, maintenance

Special operating instructions:

- Break-in procedures 112
- General driving notes 113
- Antilock Brake System (ABS) 115

Wheels and tires:

- Tire inflation pressure 116
- Tire code 118
- Tire condition 119
- Run Flat tires* 120
- New wheels and tires 121
- Snow chains* 122

In the engine compartment:

- Hood 123
- Engine compartment essentials 124
- Washer fluids 126
- Engine oil 126
- Coolant 128
- Brake fluid 128

Maintenance:

- BMW Maintenance System 130

Laws and regulations:

- California laws 132
- OBD interface socket 132

Owner service procedures

Replacement procedures:

- Onboard tool kit 136
- Windshield wiper blades 136
- Lamps and bulbs 137
- Changing a wheel 141
- Battery 145
- Fuses 145

Giving and receiving assistance:

- Receiving assistance 146
- Jump-starting 147
- Towing and tow-starting the vehicle 149

Technical data

- Engine data 154
- Dimensions 155
- Weights 156
- Capacities 157

Contents

Index	Everything from A to Z	160
--------------	------------------------	-----



Overview

Controls and features

Operation, maintenance

Owner service procedures

Technical data

Index



14 Cockpit

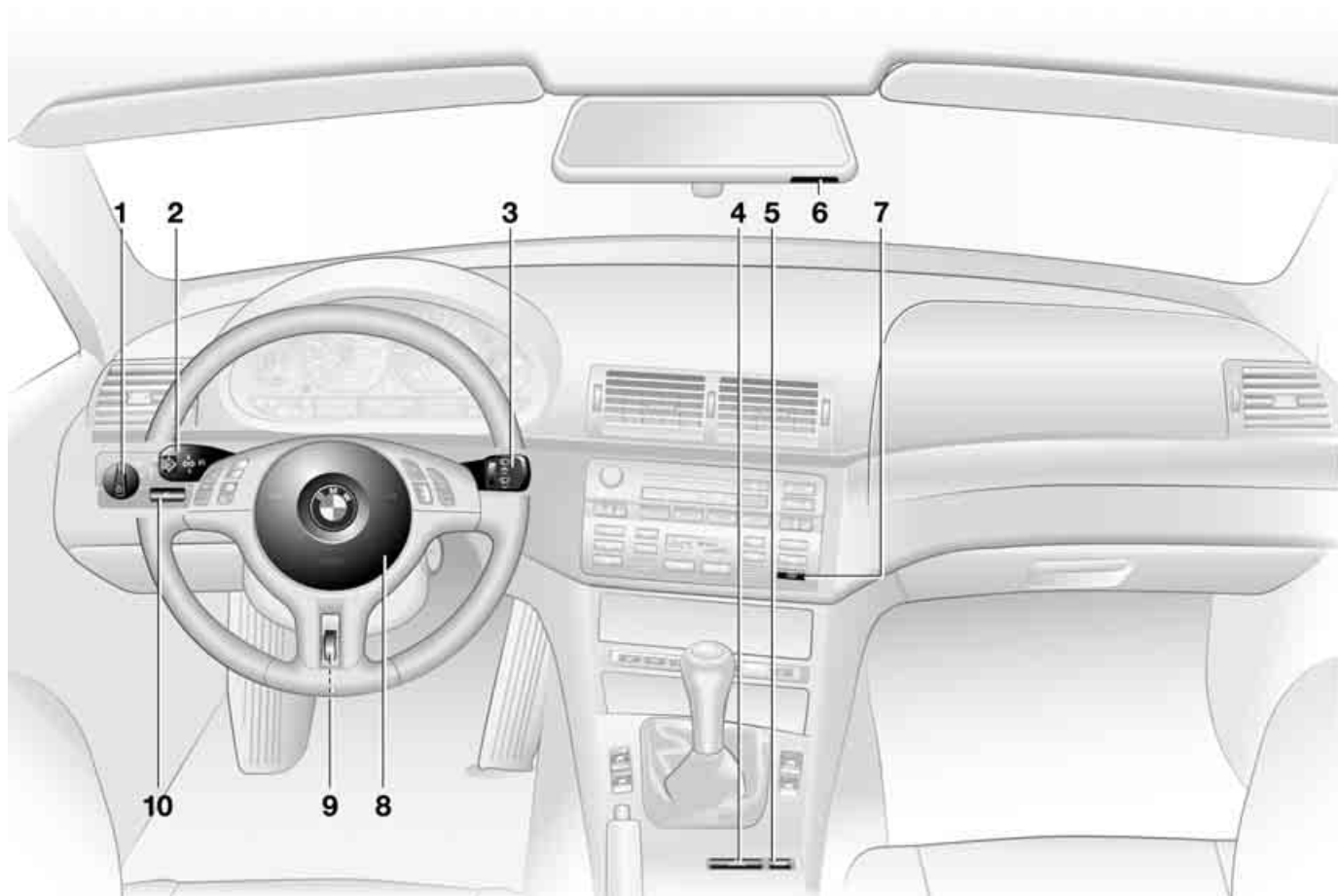

Cockpit

- 1 Parking lamps/Low beams 85
- 2 ▷ Turn signal indicators 70
 - ▷ Standing lamps 87
 - ▷ High beams 87
 - ▷ Headlamp flasher 70
 - ▷ Computer 78
- 3 Washer/wiper system/Rain sensor 71
- 4 Hazard warning flashers
- 5 Central locking system 28
- 6 ▷ Initiating an emergency call 146
 - ▷ Mobile Service 147
- 7 Rear window defroster 92, 97
- 8 Horn: the entire surface
- 9 Adjusting the steering wheel 50
- 10 Fog lamps 87

16 Instrument cluster

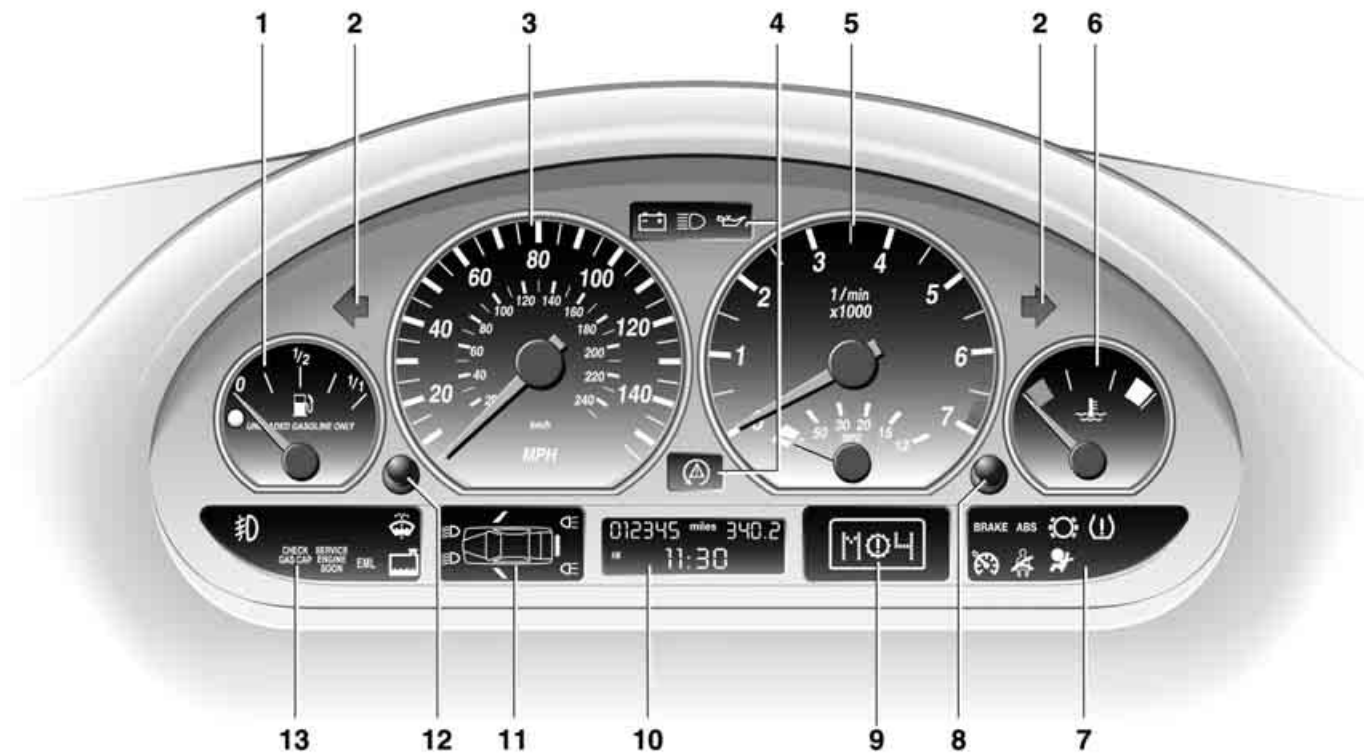

Instrument cluster

- 1 Fuel gauge 75
- 2 Indicator lamp for turn signals 20
- 3 Speedometer
- 4 Indicator and warning lamps 18 to 20
- 5 Tachometer and Energy Control 74
- 6 Engine coolant temperature gauge 75
- 7 Indicator and warning lamps 18 to 20
- 8 Control button for the clock 77
- 9 Selector lever and program display for automatic transmission/sequential manual gearbox SMG, transmission indicator lamp 19, 65, 69
- 10 Display for
 - ▷ Trip odometer/Odometer 74
 - ▷ Clock 77
 - ▷ Service interval 76
 - ▷ Computer 78
- 11 Check Control 76
- 12 Trip odometer, reset to zero 74
- 13 Indicator and warning lamps 18 to 20

18 Indicator and warning lamps

Technology that monitors itself

Indicator and warning lamps that are identified by ● are tested for proper functioning whenever the ignition key is turned. They each light up once for different periods of time.

If a fault should occur in one of these systems, the corresponding lamp does not go out after the engine is started, or it lights up while the vehicle is moving. You will see how to react to this below.

Red: stop immediately

 Battery charge current ●
The battery is no longer being charged. Indicates a defective alternator drive belt or a problem with the alternator's charge circuit. please contact the nearest BMW center.

 If the drive belt is defective, stop and switch off the engine immediately to prevent overheating and serious engine damage. If the drive belt is defective, increased steering effort is also required. ◀

 Engine oil pressure ●
The engine oil pressure is too low. Stop the vehicle immediately and switch off the engine. It is not possible to continue driving. Please contact the nearest BMW center.



 Do not continue driving, as the engine could sustain serious damage from inadequate lubrication. ◀

 Brake warning lamp ●
If the lamp comes on when the parking brake is not engaged: check the brake fluid level. It is very important that you follow the instructions on page 128 before driving on. Have the system checked immediately.

 Brake warning lamp for Canadian models.

 Flat Tire Monitor ●
In addition, an acoustic signal is sounded: there is a flat tire.
Reduce speed and carefully come to a stop. Avoid sudden braking and steering maneuvers.
For additional information, refer to page 83.

Red and yellow: continue driving cautiously

 The brake warning lamp comes on together with the yellow indicator lamps for ABS ● and DSC:
 The entire ABS, CBC and DSC control system has failed. Continue driving cautiously and defensively. Avoid hard brake applications. Please have the system checked by your BMW center as soon as possible.
Additional information beginning on 81.

 CBC, ABS and DSC and DBC indicator and warning lamps for Canadian models.



Red: an important reminder

 Brake warning lamp
Comes on when the parking brake is applied – an additional acoustic signal sounds when starting off.
For additional information, refer to page 61.

Indicator and warning lamps



Brake warning lamp for Canadian models.



Please fasten safety belts ●
Comes on together with an acoustic signal until the safety belts are fastened.

For additional information on safety belts, refer to page 46.



Airbags ●
Have the system checked as soon as possible.

For additional information, refer to page 53.

Orange: consult the nearest BMW center



Automatic transmission/sequential manual gearbox
The respective transmission has

responded to a malfunction by reverting to operation in its emergency default program. Have the system checked immediately.

For additional information, refer to pages 65, 69.

Yellow: check as soon as possible



Engine oil level

If the lamp comes on during normal vehicle operation: the engine oil level has fallen to the absolute minimum; refill as soon as possible. Do not drive more than approx. 30 miles/50 km before refilling. For additional information, refer to page 126.



Engine oil level

Comes on after the engine has been shut off: add engine oil at the earliest opportunity, such as the next time you stop to refuel. For additional information, refer to page 126.



Brake pads ●

Have the brake pads checked immediately.

For additional information, refer to page 114.



Flat Tire Monitor ●

The Flat Tire Monitor is malfunctioning or out of order. If there is a malfunction, have the system

checked. For additional information, refer to page 84.



Dynamic Stability Control (DSC) ●

Indicator lamp flashes:

The system is actively regulating drive torque and braking force.

The indicator lamp stays lit:

DSC has been switched off with the button; DTC is operational. If there is a malfunction, have the system checked.

Additional information beginning on 81.



Dynamic Stability Control (DSC) and brake warning lamp

The indicator lamps remain on: DSC/DTC have been switched off with the button or are faulty.

If there is a malfunction, have the system checked as soon as possible.

Additional information beginning on 81.



DSC indicator and brake warning lamps for Canadian models.



20 Indicator and warning lamps



Dynamic Brake Control (DBC) ●
Malfunction in the DBC system. Conventional braking efficiency is available and unrestricted. Have the system checked as soon as possible. For additional information, refer to page [115](#).



Dynamic Brake Control (DBC) warning lamp for Canadian models.



Add washer fluid
The washer fluid level is too low, top it up at the earliest opportunity. For additional information, refer to page [126](#).



CHECK GAS CAP* ●
This indicator lamp comes on when the gas cap is loose or missing. Close the gas cap tightly: refer to page [24](#).



SERVICE ENGINE SOON ●
If the indicator lamp comes on either continuously or intermittently, this indicates a fault in the emissions-related electronic systems.

Although the vehicle remains operational, you should have the systems checked by your BMW center at the earliest possible opportunity. For additional information, refer to page [132](#).



Service Engine Soon indicator lamp for Canadian models.



Engine electronics ●
There is a fault in the electronic engine-management system. You can continue to drive with reduced engine output or engine speed. Please have the system inspected at your BMW center.



Add coolant
The coolant level is too low. Add coolant at the earliest opportunity. For additional information, refer to page [128](#).

Green: for your information



Turn signal indicator
Flashes when the turn signal is operated. Rapid flashing indicates a system malfunction. For additional information, refer to page [70](#).



Cruise control
Lights up when the cruise control is activated. Ready for operation via the buttons in the steering wheel. For additional information, refer to page [72](#).



Front fog lamps
Lights up whenever you switch on the front fog lamps. For additional information, refer to page [87](#).

Blue: for your information



High beams
Comes on when the high beams are on or the headlamp flasher is actuated. For additional information, refer to pages [70](#), [87](#).

Buttons in steering wheel*

These buttons let you operate the following functions quickly and without being distracted from traffic conditions:

- ▷ Selected radio functions
- ▷ The cruise control
- ▷ Selected telephone functions
- ▷ The voice recognition system.

 The controls are active only when the corresponding systems and accessories are switched on. ◀



Press briefly:

Receive a phone call, initiate dialing, terminate a call.

Extended pressure:

Switch voice recognition on and off.

R/T

Display/hide telephone book. Display the entries one after another with the forward/backward buttons.



Forward:

- ▷ Radio
 - Press briefly: next station in station memory
 - Extended pressure: station search
- ▷ CD
 - Press briefly: jump to next track
 - Extended pressure: search function in track
- ▷ Cassette
 - Press briefly: jump to next track or stop fast forward
 - Extended pressure: fast forward
- ▷ Phone
 - Scan personal phone book.



Rewind: same functions as forward.



Volume.



Cruise control: select a stored setting.



Cruise control: store and accelerate + or decelerate and store -.



Cruise control: activate/interrupt/deactivate.

22 Hazard warning triangle*

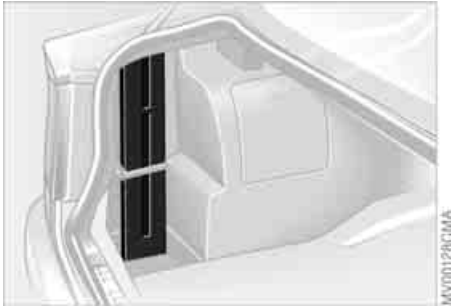

The hazard warning triangle is stored in a storage case on the left side of the luggage compartment.

 Always observe all legal regulations requiring a warning triangle to be carried in the vehicle. ◀

First-aid kit*



The first-aid kit is located under the passenger seat.

To release: pull the handle and fold the cover down.

To close: fold the cover up and press it until the tab engages.

 Several of the items contained in the first-aid pouch have a limited service life. For this reason, check the expiration dates of each of the items regularly, and replace any with passed dates. These items can be purchased in any drugstore or pharmacy. Always observe all legal regulations requiring a first-aid kit to be carried in the vehicle. ◀

Refueling

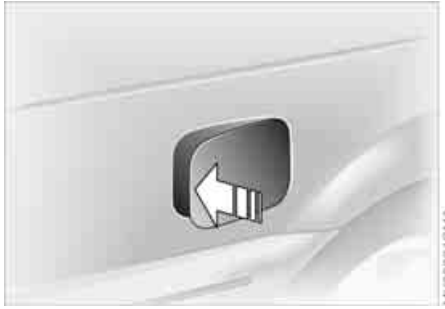

Fuel filler door

⚠ Always switch off the engine before refueling, as it is not possible to add fuel with the engine running, and attempts may also trigger the SERVICE ENGINE SOON lamp. ◀

Press on the rear edge of the fuel filler door to open and close it.

If an electrical malfunction occurs, you can unlock the fuel filler door manually: Pull the knob with the fuel pump symbol, located on the right side wall of the luggage compartment.

⚠ Always observe all safety precautions posted at the service station when handling fuel. Never carry spare fuel containers in your vehicle. Whether empty or full, these containers can leak, cause an explosion, or lead to fire in the event of a collision. ◀

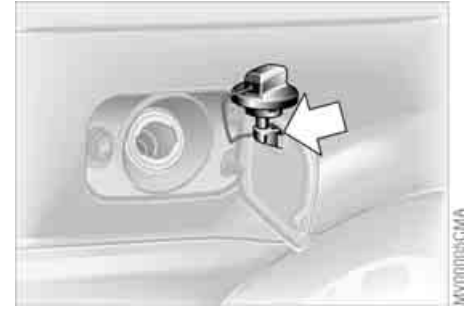

Please observe while refuelling

⚠ Open the gas cap carefully to prevent fuel from spraying out. Fuel spray may cause injury. ◀

Place the gas cap in the bracket attached to the fuel filler door.

When refueling, insert the filler nozzle in the filler pipe. Lifting the nozzle during refueling

- ▷ results in premature pump shutoff
- ▷ and will reduce the effect of the vapor recovery system on the pump.

The fuel tank is full when the filler nozzle shuts off the first time.

Closing the gas cap

Place the cap in position and turn it until a clearly audible click is heard.

 Close the gas cap carefully after refueling until a click is heard. While closing, be sure not to squeeze the strap which is fastened to the cap. A loose or missing cap will activate the CHECK GAS CAP* lamp. ◀

 Warning lamp* lights up. The gas cap is not properly closed or is missing. Check if the gas cap is properly closed.

Fuel tank capacity

▷ Approx. 16.6 gal./63 liters, of which
▷ approx. 2.1 gal./8 liters are reserve capacity.

 Do not drive to the last drop of fuel. This can prevent the engine from operating properly and result in damage. ◀

Fuel specifications

The engine uses lead-free gasoline only.

Required fuel

Premium Unleaded Gasoline,
Minimum Octane Rating: AKI 91.

Minimum Octane Rating corresponds to the Anti Knock Index AKI and is determined according to the so-called (R+M)/2 method.

 Do not use leaded gasoline, as otherwise the lambda probe and catalytic converter will be permanently damaged. ◀

Use high-quality brands

Field experience has indicated significant differences in fuel quality: volatility, composition, additives, etc., among gasolines offered for sale in the United States and Canada. Fuels containing up to and including 10 % ethanol or other oxygenates with up to 2.8 % oxygen by weight, that is, 15 % MTBE or 3 % methanol plus an equivalent amount of co-solvent, will not void the applicable warranties with respect to defects in materials or workmanship.

 The use of poor-quality fuels may result in drivability, starting and stalling problems especially under certain environmental conditions such as high ambient temperature and high altitude.

Should you encounter drivability problems which you suspect could be related to the fuel you are using, we recommend that you respond by switching to a recognized high-quality brand.

Failure to comply with these recommendations may also result in unscheduled maintenance. ◀

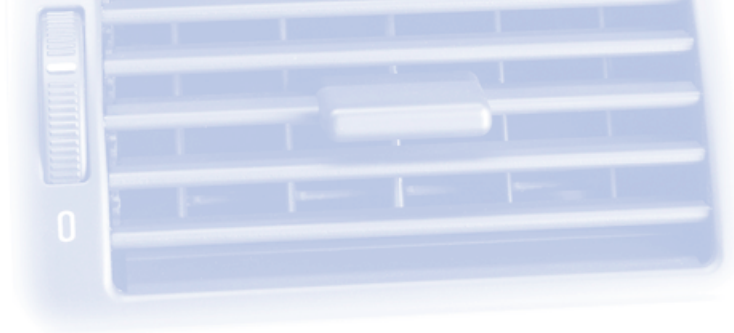

Overview

Controls and features

Operation, maintenance

Owner service procedures

Technical data

Index

Overview

Controls

Maintenance

Repairs

Data

Index



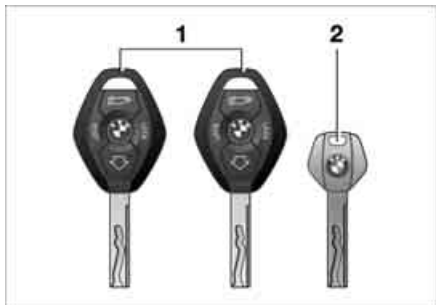

The key set

- 1 Master keys with remote control. They govern the functions of the Key Memory. Certain functions in your vehicle may operate differently depending on the key, refer to page 58. To distinguish between keys, you can mark each key with remote control by applying one of the colored decals that you received when accepting delivery of your vehicle

▷ In every master key with the remote control feature there is an extended-life battery that is charged automatically in the ignition lock as you drive. Therefore, use otherwise unused master keys for a longer journey every six months so that the battery can be charged. ◀

- 2 Spare key – for storage in a safe place, such as in your wallet. This key is not intended for constant use. The luggage compartment lid and the glove compartment cannot be locked and unlocked with this key. This is useful for valet parking, for example

Central locking system

The concept

The central locking system is ready for operation whenever the driver's door is closed. The system simultaneously engages and releases the locks on the

- ▷ doors
- ▷ luggage compartment lid
- ▷ fuel filler door.

The central locking system can be operated

- ▷ from outside via the remote control as well as via the driver's door lock
- ▷ from inside by pressing a button.

The fuel filler door is not locked when the central locking system is activated from the inside, refer to page 32. When the system is actuated from the outside, the anti-theft system is also activated. This prevents the doors from being unlocked via the lock buttons or the release handle. The alarm system is also activated or deactivated.

If locked from the inside, the central locking system unlocks automatically in the event of an accident, except on doors that have been locked individually using the lock buttons, refer to page 32. In addition, the hazard warning flashers and interior lamps come on.

Opening and closing – via the remote control

The concept

The remote control also provides two additional functions beyond the central locking feature:

- ▷ To switch on interior lamps, refer to page 30.
With this function you can also search for your vehicle when parked in an underground garage, for instance
- ▷ To open the luggage compartment lid, refer to page 30.
The luggage compartment lid will open slightly, regardless of whether it was previously locked or unlocked.

Whenever you unlock or lock the vehicle, you simultaneously deactivate/activate the anti-theft system, disarm/arm the alarm system and switch the interior lamps on/off.



You can have a signal set to confirm that the vehicle's locks have engaged securely. ◀

Master keys with remote control



Persons or animals inside the vehicle may be able to lock the doors from the inside. For this reason, always take the vehicle keys with you so that the vehicle can be opened again from the outside at any time. ◀



If it is no longer possible to lock the vehicle via the remote control, the battery is discharged. Use this key while driving for an extended period in order to recharge the battery. To prevent unauthorized use of the remote control, surrender only the spare key when leaving the vehicle for valet parking, for example. In the event of a system malfunction, please contact your BMW center. You can also obtain replacement keys there. ◀



- 1 Unlock, convenience opening mode, and disarm alarm system
- 2 Lock and secure, arm alarm system, activate interior lamps, disarm tilt alarm sensor and interior motion sensor
- 3 Open the luggage compartment lid, Panic mode – trigger alarm

To release



Press the button once to unlock the driver's door.

Press the button a second time to disengage all vehicle locks.

30 Opening and closing – via the remote control

Convenience opening mode



Press the button briefly and then keep it pressed. The electric power windows and the glass sunroof open.

To lock and secure



Press button.

To switch on the interior lamps



With the vehicle locked, press button. With this function, you can also search for your vehicle when parked in an underground garage, for instance.

To open the luggage compartment lid



Press button briefly.

The luggage compartment lid will open slightly, regardless of whether it was previously locked or unlocked.



If the vehicle was previously locked, the luggage compartment is also locked again after it is closed. Before and after a trip, be sure that the luggage compartment lid has not been opened unintentionally. ◀

Panic mode* – trigger alarm



By pressing the button for more than 2 seconds, the alarm system* can be triggered in the event of danger, if the system is armed.

To switch off the alarm:



Press button.

External systems

Malfunctions:

Local radio waves can impede the functioning of the remote control.

If this occurs, open and close the vehicle using a master key in the door lock.

For US owners only

The transmitter and receiver units comply with part 15 of the FCC Federal Communications Commission regulations. Operation is governed by the following:

FCC ID:

- ▷ LX8EWS
- ▷ LX8FZVS
- ▷ LX8FZVE.

Compliance statement:

This device complies with part 15 of the FCC Rules. Operation is subject to the following two conditions:

- ▷ This device may not cause harmful interference, and
- ▷ this device must accept any interference received, including interference that may cause undesired operation.



Any unauthorized modifications to these devices could void the user's authority to operate the equipment. ◀

Opening and closing – via the door lock

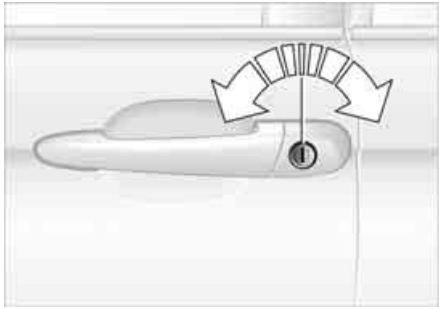

Whenever closing the windows or sliding/tilt sunroof you should always monitor their path and progress to ensure that no one is injured. Release the key to stop the windows or sliding/tilt sunroof. ◀

Manual operation

If there is an electrical malfunction, you can unlock or lock the driver's door by turning the key in the lock all the way to the left or right.

One turn of the key in the driver's door lock unlocks the driver's door only. Turning the key a second time unlocks the passenger-side door, the luggage compartment lid and the fuel filler door.



You can have a signal set to confirm that the vehicle's locks have engaged securely. ◀

Convenience operation

You can also operate the power windows and the glass sunroof via the door lock.

- ▷ To open: with the door closed, hold the key in the Unlock position
- ▷ To close: with the door closed, hold the key in the Lock position.



You can use this button to control the central locking system whenever the doors are closed. The doors and luggage compartment lid are unlocked or locked only. The anti-theft system is not activated.

 If only the driver's door was unlocked from the outside and you press the button, then, with the driver's door still open, the passenger-side door, the luggage compartment lid and the fuel filler door will unlock, too. If the driver's door is closed, it will be locked. ◀

 If you desire, the central locking system can be activated automatically as soon as you begin to drive. This can be adjusted to be key-specific. ◀

To unlock and open the doors

1. Press the button for the central locking system
2. Pull the release handle above the armrest on the door you wish to open

or

pull the release handle for any door twice: to unlock and open the door.

To lock

- ▷ Either use the central locking button to lock both doors at once or
- ▷ press the individual door lock buttons down. In this case, the fuel filler door will stay unlocked. To prevent the driver from being inadvertently locked out of the vehicle, the driver's door lock button will not engage as long as the door is open.

 Persons or animals inside the vehicle may be able to lock the doors from the inside. For this reason, always take the vehicle keys with you so that the vehicle can be opened again from the outside at any time. ◀

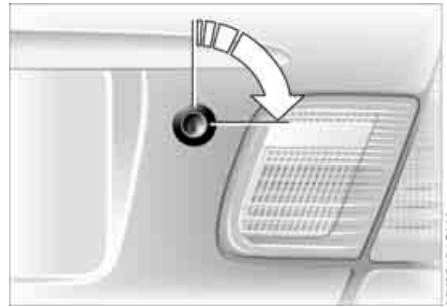
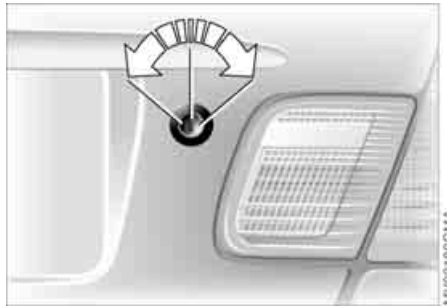

The lock

Only the master keys fit in the lock for the luggage compartment lid, refer to page 28.

To secure separately

Turn the master key to the right past the resistance point and then pull it out in the horizontal position.

This locks the luggage compartment lid and disconnects it from the central locking system. This feature can be used to prevent unauthorized access to the luggage compartment when you surrender the spare key only, refer to page 28. This can be advantageous for valet parking, for example.

To open from the outside

Press the button in the handle recess: the luggage compartment lid opens slightly.

The luggage compartment is lit when it is opened.

Manual operation

In the event of electrical malfunction
Turn the master key all the way to the left – the luggage compartment lid will open slightly.

The luggage compartment lid is locked again as soon as you close it.

To open from the inside, refer to the following section.

34 Luggage compartment lid

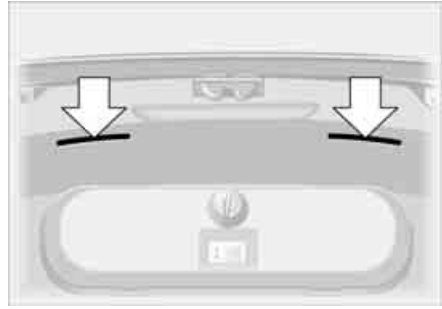



To open from the inside*

If the luggage compartment lid has not been locked separately, you can open it with this button in the footwell on the driver's side when the vehicle is stationary.

To close

The handle recesses in the interior trim panel of the luggage compartment lid make it easier to pull the lid down.

 To avoid injuries, be sure that the travel path of the luggage compartment lid is clear when it is closed, following the same precautions as with all closing procedures. ◀

 Operate the vehicle only when the luggage compartment lid is completely closed. Otherwise, exhaust fumes could penetrate the interior of the vehicle. ◀

If at any time it does become necessary to operate the vehicle with the luggage compartment lid open:

1. Close all windows and the glass sunroof
2. Greatly increase the quantity of air coming from the air conditioning or automatic climate control system, refer to page 90 or 94.

Luggage compartment lid



Emergency release

This lever releases the luggage compartment lid from the luggage compartment's interior.

Luggage compartment 35

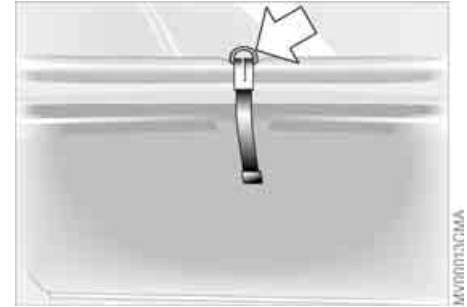

Floor panel

Lift the floor panel with the ring, then use the tab to suspend it from the weather-stripping on the drip rail.

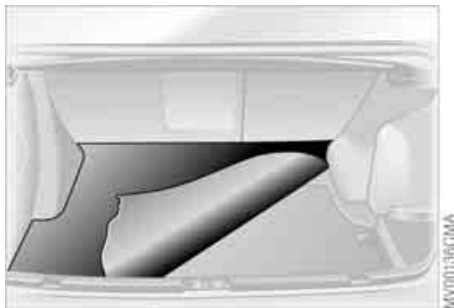

Floor mat

You can turn the floor mat over to transport soiled objects, etc. The rubber-coated side is suitable for washing and is also designed to inhibit sliding.

The fittings at the corners of the luggage compartment provide you with a convenient means of attaching luggage compartment nets* and flexible straps for securing luggage.

Refer also to Cargo loading on page 106.

Alarm system*

The concept

The vehicle alarm system responds:

- ▷ When a door, the hood or the luggage compartment lid is opened
- ▷ To movement inside the vehicle – interior motion sensor
- ▷ To variations in the vehicle's tilt angle such as those occurring during attempts to steal the wheels or tow the vehicle – tilt alarm sensor.
- ▷ To interruption of battery voltage.

The system responds to unauthorized vehicle entry and attempted theft by simultaneously activating the following:

- ▷ The acoustic alarm sounds for 30 seconds
- ▷ The hazard warning flashers are activated for approx. five minutes
- ▷ The high beams flash on and off in rhythm with the hazard warning flashers.

To arm and disarm the alarm system

When the vehicle is locked or unlocked via the remote control or the driver's door lock, the alarm system is also simultaneously armed or disarmed.



You can have different acknowledgment signals set to confirm arming and disarming. ◀



You can also open the luggage compartment lid when the system is armed by pressing the remote control button, refer to page 30. The lid is once again secured when it is closed.

Extended pressure on the button sets off the alarm – Panic mode, refer to page 30.

Alarm system*



Indicator lamp displays

- ▷ The indicator lamp below the interior rearview mirror flashes continuously: the system is armed
- ▷ The indicator lamp flashes immediately after the vehicle is locked: doors or luggage compartment lid are not completely closed. Even if you do not close the alerted area(s), the remaining areas are secured, and the indicator lamp will flash continuously after 10 seconds. However, the interior motion sensor is not activated
- ▷ The indicator lamp goes out immediately after the vehicle is unlocked: no manipulation or attempted intrusions have been detected in the period since the system was armed
- ▷ The indicator lamp flashes for 10 seconds immediately after the

system is armed: an attempted entry has been detected in the period since the system was armed.

Following triggering of an alarm, the indicator lamp will flash continuously.

Tilt alarm sensor and interior motion sensor

Tilt alarm sensor:

The tilt of the vehicle is monitored. The alarm system reacts, for example, to attempts to steal the wheels or tow the vehicle

Interior motion sensor:

In order for the interior motion sensor to function properly, the windows and the glass sunroof must be completely closed.

Avoiding unintentional alarms

The tilt alarm sensor and interior motion sensor may be switched off at the same time. You can do this to prevent a false alarm, e.g. in the following situations:

- ▷ In garages with elevator ramps
- ▷ When the vehicle is being transported by train
- ▷ When animals are to remain in the vehicle.

To deactivate the tilt alarm and interior motion sensors



- ▷ Press the button on the remote control twice.

The indicator lamp lights up briefly and then flashes continuously. The tilt alarm sensor and the interior motion sensor are deactivated until the vehicle is unlocked and locked again.



- You can have the tilt alarm sensor and the interior motion sensor permanently deactivated. ◀



- The system inadvertently deactivates the tilt alarm sensor and the interior motion sensor if the convenience closing of windows and glass sunroof is interrupted within the first 10 seconds and then restarted. The vehicle must then be unlocked and relocked before the sensors will resume operation. ◀



To open and close windows

With the ignition key in position 1 or higher:

- ▷ Press the switch to the resistance point: the window retracts, or respectively the tilt-out window moves outward; it remains in motion for as long as you maintain pressure on the switch
- ▷ Press the switch briefly past the pressure point: the window moves automatically. Pressing the switch again stops the opening cycle.

You can close the window in the same manner by pulling the switch. The tilt-out window does not close automatically.

After the ignition has been switched off: You can still operate the electric power windows for up to 15 minutes, as long as no one opens either of the doors.

 When leaving the vehicle, always remove the ignition key from the lock and remember to close the doors to prevent children from operating the power windows and injuring themselves, etc. ◀

For convenience operation via the remote control or the door lock, refer to page 30 or 31.

Trap protection

The front windows are each equipped with a contact strip located on the upper inside of the window frame. If pressure is exerted against this contact strip while the window is being raised, the system will respond by stopping the window and then retracting it a small distance.

 Despite trap protection, always be careful to ensure that the closing path of the window is not obstructed. Some types of objects, for instance very thin objects, might fail to trigger the contact strip in some situations. If the switch is pulled and held beyond the resistance point, this trap protection is overridden. ◀

Glass sunroof, electric*

 To prevent injuries, exercise care when closing the glass sunroof and keep it in your field of vision until it is shut.

When leaving the vehicle, always remove the ignition key from the lock and remember to close the doors to prevent children from operating the glass sunroof and injuring themselves, etc. ◀

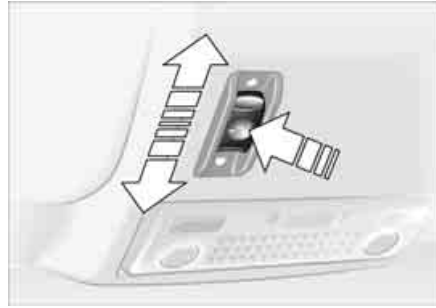

Opening and closing

With the ignition key in position 1 or higher.

- ▷ Slide the switch until you feel resistance: the glass sunroof opens and closes as long as you hold the switch
- ▷ Slide the switch past the pressure point: the glass sunroof moves automatically.

Tapping the switch again stops the motion immediately.

The headliner insert retracts with the glass sunroof while it is opening.

After the ignition has been switched off: you can still operate the glass sunroof for up to 15 minutes, as long as no one opens either of the doors.

For the convenience mode via the remote control or the door lock, refer to page 30 or 31.

Raising the glass sunroof

With the ignition key in position 1 or higher: tap the switch.

Tapping the switch again stops the motion immediately.

If you briefly press the switch in the raise direction while the glass sunroof is open, the sunroof will rise to its uppermost position.

After the ignition has been switched off: you can still operate the glass sunroof for up to 15 minutes, as long as no one opens either of the doors.

The headliner insert slides back somewhat when you raise the glass sunroof.

 Do not use force to close the headliner insert with the sunroof in its raised position, otherwise the mechanism will be damaged. When leaving the vehicle, always remove the ignition key from the lock and remember to close the doors, otherwise children could operate the sunroof and injure themselves, etc. ◀

Trap protection

If the glass sunroof encounters resistance when closing from approximately the half-closed position or when closing from the raised position, the closing operation is interrupted and the glass sunroof reopens slightly.



Despite trap protection, always make sure that the sunroof can close without obstruction, otherwise in some cases, e.g. with thin objects, it is not guaranteed that the closing operation will be interrupted.

Trap protection is restricted when the switch is pressed and held beyond the pressure point. The sunroof opens only slightly. If the switch is pressed and held beyond the pressure point again within approx. 2 seconds, trap protection is overridden. ◀

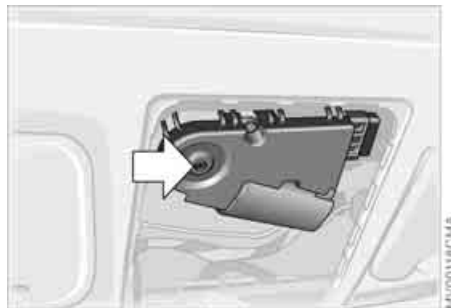

Manual operation

The glass sunroof can also be operated manually in the event of an electrical malfunction.

1. Pull out the switch, then reach into the exposed opening and press out the cover
2. Use the Allen key from the onboard tool kit, refer to page 136, to turn the glass sunroof in the desired direction.

Initializing the glass sunroof



If the glass sunroof can no longer be automatically opened or closed after manual operation, it must be initialized. ◀

With the key in ignition position 1 or higher, press and hold the switch beyond the pressure point until the glass sunroof moves slightly.

Safe seating position

For driving that is relaxed and less likely to cause fatigue, you should select a sitting position that reflects your personal requirements. In combination with the safety belts and airbags, the correct seating position also plays an important role in enhancing occupant safety in the event of an accident. To ensure that the vehicle's safety systems provide you with optimal protection, we request that you direct your careful attention to the following section.

For supplementary information on transporting children, refer to page 54.

Sitting safely with airbags

 Always maintain an adequate distance between yourself and the airbags. Always hold the steering wheel by the rim to keep any chance of injury to hands or arms to an absolute minimum should the airbag be deployed. Never allow any objects, individuals or animals to obstruct the areas between passengers and airbags. Never use the front airbag's cover as a storage tray or support for objects of any kind. Never allow front passengers to rest their feet or legs on the airbag cover. ◀

For airbag locations and additional information on airbags, refer to page 51.

Sitting safely with safety belts

Your vehicle offers five sitting positions, each of which is provided with a safety belt.



Never allow more than one person to wear a single safety belt. Never allow infants or small children to ride in a passenger's lap. Avoid twisting the belt while routing it firmly across the pelvis and shoulder, wear it as snugly against your body as possible. Do not allow the belt to rest against hard or fragile objects. Do not route the belt across your neck, or run it across sharp edges. Be sure that the belt does not become caught or jammed. Avoid wearing bulky clothing and pull on the lap belt periodically to retension it over your shoulders. In the event of a frontal impact, a loose lap belt could slide over the hips, leading to abdominal injury. In addition, the safety belt's restraint effectiveness is reduced if it is worn loosely. Expectant mothers should always wear their safety belts, taking care to position the lap belt against the lower hips, where it will not exert pressure against the abdominal area. ◀

For information on using the safety belts, refer to page 46.

Manual seat adjustment

When adjusting your seat, always observe the following precautions

 Never try to adjust your seat while operating the vehicle. The seat could respond with an unexpected movement, and the ensuing loss of vehicle control could lead to an accident. Never ride with the backrest reclined to an extreme angle. This is especially important for the front passenger to remember. If you do, there is a risk that you will slide under the safety belt in an accident, thus reducing the protection provided by the safety belt. ◀

Seat adjustment

- ▷ Manual seat adjustment, refer to page 42
- ▷ Power seat adjustment, refer to page 44
- ▷ Head restraint, refer to page 45
- ▷ Entering the rear, refer to page 45.

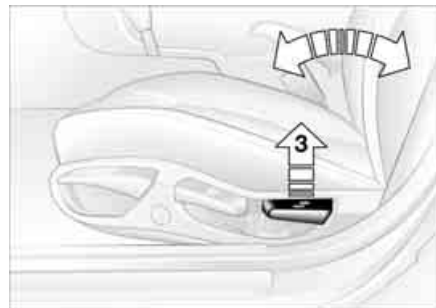
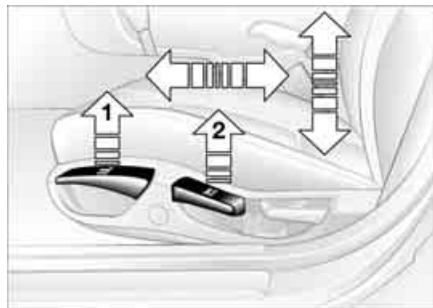

Seat adjustment

- 1 **Forward/backward adjustment**
Pull the lever and slide the seat to the desired position.
After you release the lever, move the seat forward or backward slightly so that it engages fully
- 2 **Cushion height**
Pull the lever and apply weight to or remove weight from the seat as required
- 3 **Backrest angle**
Pull the lever and apply weight to or remove weight from the backrest to reach the desired position

Manual seat adjustment

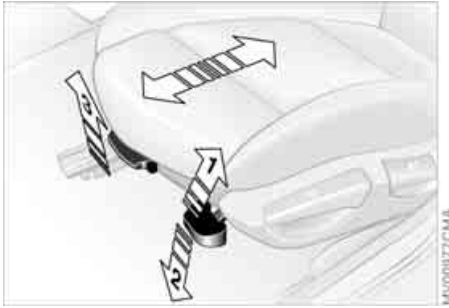

BMW sports seat* adjustment

You can also adjust the tilt angle and the thigh support:

- 1 To tilt up:
Pull the lever up repeatedly, continuing until the seat reaches the desired tilt angle
- 2 To tilt down:
Push the lever down repeatedly, continuing until the seat reaches the desired tilt angle
- 3 Thigh support:
Pull the lever and adjust the position of the cushion for thigh support as desired

44 Power seat adjustment*

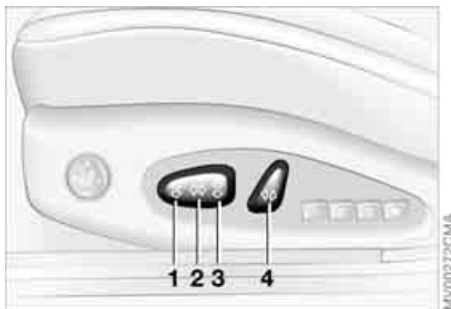

Seat adjustment

- 1 Tilt angle
- 2 Forward/backward adjustment
- 3 Cushion height
- 4 Backrest angle

The head restraint is adjusted manually, refer to page 45.

With the BMW sports seat you can also adjust the thigh support, refer to page 43.

 Please refer to the adjustment instructions on page 42 to reduce the risk of personal injury. ◀

Lumbar support*



Adjustments

You can adjust the backrest's contour to support the lordosis of the spine, i.e. the curvature of its lumbar section.

The upper hips and spinal column receive supplementary support to help you maintain a relaxed, upright posture.

- ▷ Press the front or rear of the switch: increase or decrease the curvature
- ▷ Press the upper or lower end of the switch: shift the curvature up or down.

Head restraints

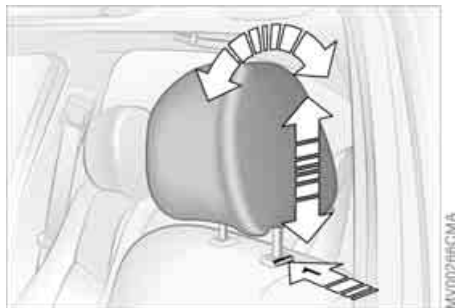

1. Pull up the head restraint, continuing until it is at maximum extension
2. Press button – see arrow 1 – and remove the head restraint.

Installation – front

Slide the head restraint into the sockets.

Adjustments

Height: adjust by pulling up or pressing down.

- ▶ Press button to retract to the lowest position – see arrow 1. ◀

Adjust the angle of the front head restraints by tilting them manually.

- ⚠ You can reduce the risk of spinal injury and whiplash by adjusting the head restraint to a height at which it is centered roughly at ear level. ◀

Removal – front

1. Pull up the head restraint, continuing until it is at maximum extension

Entering the rear

45

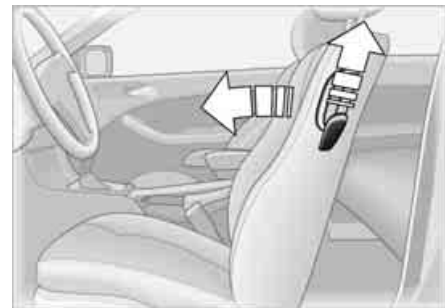

To release the backrest

Pull the lever upward and fold the backrest forward.

- ⚠ Lock both backrests while driving, otherwise there is a danger of an unexpected movement causing an accident. ◀



acoustic signal sounds if the driver or front passenger unfastens his or her safety belt while the vehicle is in motion.

To release

1. Press red button in the belt buckle
2. Hold the end of the belt
3. Guide belt back into the inertia reel.

 The rear belt buckle with the word **CENTER** is intended exclusively for the passenger sitting in the middle. ◀

Always wear your safety belt

Always fasten your safety belt before starting off. As supplemental restraint devices, the airbags are designed to enhance the effectiveness of the safety belts, and not to replace them.

To close

Make sure you hear the catch engage in the belt buckle.



The warning lamp lights up after a short driving distance until the driver and front passenger have fastened their safety belts. At the same time, an acoustic signal is sounded. The warning lamp also lights up and the

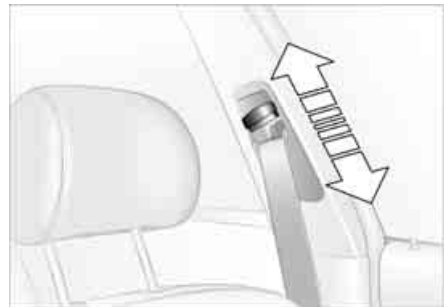

Adjusting safety belt height

Use the height adjustment mechanism to adapt the shoulder strap to the ideal level for your own body:

▷ Slide button up or down.

Please refer to the seat adjustment instructions on page 41.



If the safety belt system has been subjected to the stresses involved in an accident or otherwise damaged: have the entire safety belt mechanism replaced by your BMW center, including the safety belt tensioner. In addition, have your BMW center inspect the safety belt anchors. If a child-restraint system was in the vehicle during an accident, consult the manufacturer's instructions regarding replacement. ◀

Seat and mirror memory*

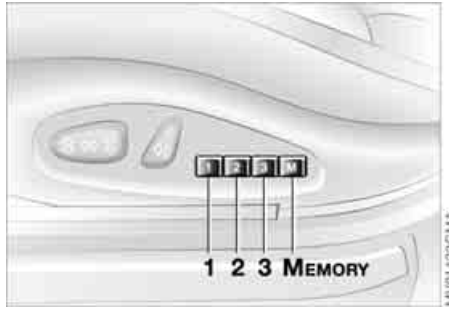

You can store and recall three different driver's seat and exterior mirror positions.

 Memory will not retain the adjustment made to the lumbar support. ◀

To store

1. Ignition key position 1 or 2
2. Adjust your seat and exterior mirrors to the desired position
3. Press the MEMORY button: the indicator lamp in the button lights up
4. Press memory button 1, 2 or 3, as desired. Indicator lamp goes out.

To select a stored setting

 Do not select a memory position while the vehicle is moving. If you do so, there is a risk of accident from unexpected seat movement. ◀

Ignition key in position 1:

- ▷ Briefly press memory button 1, 2 or 3, as desired.
Movement stops immediately when one of the seat-adjustment or memory buttons is activated during the adjustment process.

The driver's door is closed and the ignition key is either removed or in position 0 or 2:

- ▷ Press and hold the desired memory button – 1, 2 or 3 – until the adjustment process is completed.

If you press the MEMORY button accidentally: press the button again; the indicator lamp goes out.

 Your BMW center can adjust your vehicle's systems in such a manner that your personalized settings are automatically set for the seat and exterior mirror positions when you unlock the vehicle with your personal remote control. ◀

 Before activating the programmed adjustment feature, ensure that the footwell behind the driver's seat is empty and unobstructed. If you fail to do so, persons, animals or objects could be injured or damaged if the seat should move backward. ◀

48 **Seat and mirror memory***

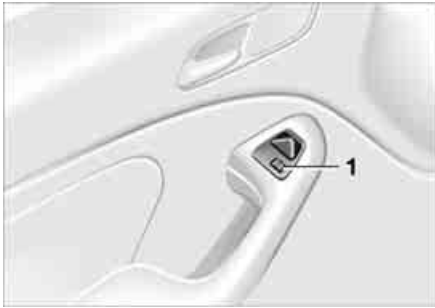

How far the passenger mirror tilts can be set individually for each ignition key. ◀

Passenger-side exterior mirror tilt function

Automatic curb monitor*

To activate:

1. Select the driver's mirror using the mirror selector switch 1
2. When shifting into Reverse or placing the selector lever in position R, the passenger-side mirror tilts downward. This allows the driver to see the area directly adjacent to the vehicle, e.g. the curb, during parking.

To deactivate:

Set the mirror selector switch to the passenger-side position.

Seat heating*

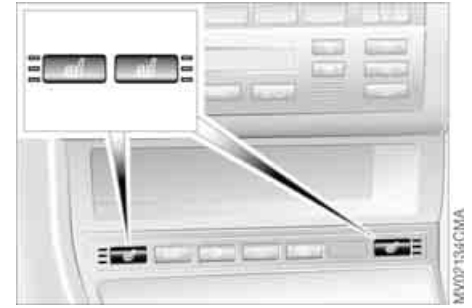

The seat cushion and backrest can be heated with the ignition key in position 2.

You can select different heating modes by repeatedly pressing the buttons.

You can also switch the higher heating modes off directly:

Press the button and hold it slightly longer.

Mirrors

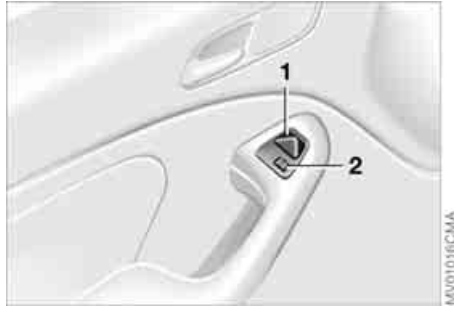

Electric defrosting*

Both mirrors are automatically heated when you turn the ignition key to position 2.

To adjust exterior mirrors

- 1 Switch for 4-way adjustment
- 2 Switch to select between mirrors

To adjust manually

The mirrors can also be adjusted by hand: press against the edges of the lens.

For storing mirror settings, refer to Seat and mirror memory on page 47.



The mirror on the passenger's side is convex. When estimating the distance between yourself and other traffic, bear in mind that the objects reflected in the mirror are closer than they appear. This means that estimates of the distance to following traffic should not be regarded as precise. ◀



Interior rearview mirror

To reduce glare from vehicles behind you when you are driving at night, tilt the lens by turning the button.

Vehicles without alarm system:
Tilt the small lever forward.



Interior rearview mirror with automatic dimming feature*

While the vehicle is being driven forward, this mirror dims light through an infinitely variable range depending on the light's incidence. Two photocells in the interior rearview mirror serve this purpose. One is positioned in the mirror, while the other is slightly offset on the opposite side of the mirror.

To ensure perfect functioning, keep the photocells clean and the area between the interior rearview mirror and the windshield free of any obstruction like stickers, etc.

Steering wheel

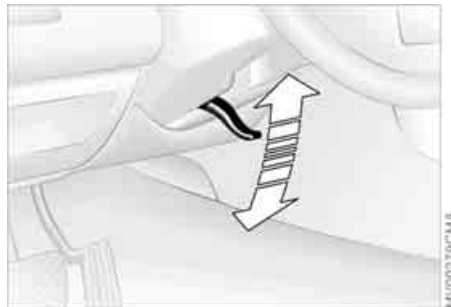

Setting

 Do not adjust the steering wheel while the vehicle is moving, otherwise you run the risk of an accident due to unexpected movement. ◀

1. Push the locking lever downward
2. Adjust steering column reach and height for your selected seating position
3. Pull the lever back up.

Airbags

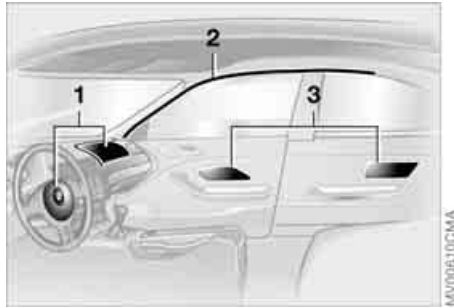

- 1 Front airbags on the driver and passenger sides
- 2 Head airbags for driver and front passenger
- 3 Side airbags on the driver and passenger sides – front and rear*

Protective effect

The front airbags supplement the three-point safety belts by providing additional protection in the event of a severe frontal collision in which the protection afforded by the belts alone may no longer be sufficient. The head and side airbags help provide protection in the event of a collision from the side. The respective side airbag helps support the seat occupant's upper body.

For information on the correct sitting posture, refer to page 41.

- ▶ The side airbags in the rear passenger area* of your vehicle may already have been deactivated by a BMW center. You may have them activated if you desire to do so. Please contact your BMW center for additional information. ◀
- ▶ The airbags do not deploy in response to minor collisions, rear impacts and certain kinds of vehicle rollover. ◀



Do not apply adhesive materials to the cover panels of the airbags, cover them or modify them in any other way. Do not remove the airbag restraint system. In the event of a malfunction, deactivation or triggered activation – as a response to an accident – of the airbag restraint system, solely consult your BMW center for inspection, repair or disassembly. Do not modify or tamper with either the wiring or the individual components in the airbag system. These include the upholstered covers on the steering wheel, the instrument panel, side panels on doors and in the rear and the roof struts as well as down the sides of the roof liners. Also, do not attempt to remove the steering wheel. Unprofessional attempts to service the system could lead to failure in an emergency or undesired airbag activation, either of which could result in personal injury. Do not touch the individual components immediately after the system has been activated, as this could result in personal injury. ◀

52 Airbags



All vehicle occupants should always sit upright and be properly restrained – infants and small children in appropriate child-restraint systems; larger children and adults using the safety belts. Never let an occupant's head rest near or on a side airbag because the inflating airbag could cause a serious or fatal injury. Please note that the word Airbag imprinted on the door trim panel indicates the airbag's location.

Accident research shows that the safest place for children in an automobile is in the rear seat. However, a child sitting in the rear seat and not properly restrained may place his or her head on or near the airbag, if so equipped. For example, a child – even though belted in – may fall asleep with his or her head against the side airbag. It may be difficult for a driver to ensure that children in the rear seat will remain properly positioned at all times and do not place their heads on or near the side airbag. Therefore, we recommend that the rear-seat side airbags, if installed in the vehicle, be deactivated if children will be riding in the rear seat.

The rear seat side airbags may already have been deactivated by a BMW center. If you are uncertain of their status,

or wish to have the airbags activated or deactivated, please contact your BMW center. ◀

Even when all these guidelines are observed, there is still a small residual risk of injuries to the face, hands and arms occurring from airbag deployment in isolated instances.

In sensitive individuals, the ignition and inflation noise may induce a mild hearing loss that is temporary in most cases.

Corresponding airbag warning labels are found on both sun visors.



This is the right way a child should sit in a child restraint when rear side airbags are provided.

Airbags



This is the right way a larger child should sit wearing the seat belt when rear side airbags are provided.

Indicator lamp



The indicator lamp indicates the operational status of the airbag system when the ignition key is in position 1 or higher.

System operational:

- ▷ The indicator lamp comes on briefly when you turn the ignition key to position 1 or higher.

System malfunction:

- ▷ Indicator lamp does not come on or
- ▷ indicator lamp lights up continuously.



If there is a system malfunction, there is a risk that the airbags will not be triggered within their normal response range, even if the level of impact would normally have triggered them. Have your BMW center inspect the airbag system immediately. ◀

54 Transporting children safely

Commercially available child-restraint systems are designed to be secured with a lap belt or with the lap belt portion of a combination lap/shoulder belt. Improperly or inadequately installed restraint systems can increase the risk of injury to children. Always read and follow the instructions that come with the system.

Correct location for installing

In your BMW, all seats equipped with a three-point safety belt – except for the driver's seat – are suitable for installing universal child-restraint systems of all age classes and which have been approved for the age group in question.

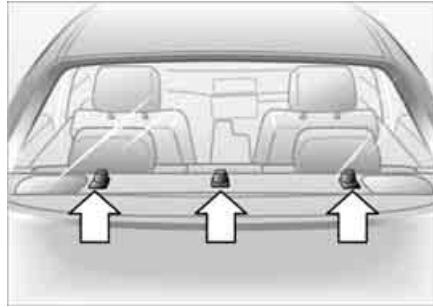

Child-restraint system with tether strap

If you use a child-restraint system with a tether strap, three additional tether anchorage points have been provided.

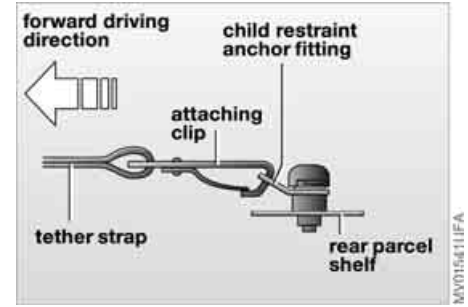

Depending on the location selected for seating in the rear passenger area, attach the tether strap to the corresponding anchorage point to secure the child-restraint system, as shown in the illustration.

If the respective seating position is fitted with a head restraint, lift the head restraint, and pass the tether strap between the head restraint and the seat back.

It is recommended to readjust the head restraint in the lowest possible position.

Adjust the tether strap according to the child-restraint manufacturer's instructions.

Transporting children safely



Before installing any child-restraint device or child seat, please read the following: Never install a rearward-facing child-restraint system in the front passenger seat of this vehicle.

Your vehicle is equipped with an airbag supplemental restraint system for the front passenger. Because the backrest on any rearward-facing child-restraint system – of the kind designed for infants under 1 year and 20 lbs/9 kg – would be within the airbag's deployment range, you should never mount such a device in the front passenger seat, since the impact of the airbag against the child-restraint's backrest could lead to serious or fatal injuries. If it is necessary for a child – not an infant – to ride in the front seat, certain precautions should be taken. First, move the passenger seat as far away from the dashboard as possible. This important precaution is intended to maximize the distance between the airbag and the child. Older children should be tightly secured with a safety belt after they have outgrown a booster seat that is appropriate for their age, height, and weight. Younger children should be secured in an appropriate forward-facing child-restraint system

that has first been properly installed with a safety belt. Never install a rearward-facing child-restraint system in the front passenger seat.

We strongly urge you to carefully read and comply with the instructions for installation and use provided by the child restraint's manufacturer whenever you use such a device. Do not attempt to modify child-restraint systems. If you do this, the protection provided by these systems could be impaired.

Always ensure that all occupants – of all ages – remain properly and securely restrained at all times. ◀

All rear seating positions in your vehicle meet the recommendations of SAE J1819, an industry-recommended practice for securing child-restraint systems in motor vehicles.



Securing child-restraint system

All of the rear belt retractors and the front passenger's safety belt can be locked for mounting and securing child-restraint systems.

A label with the appropriate instructions for this is located in the immediate vicinity of the buckle latch of each safety belt.

To lock the safety belt

Extract the entire length of the belt from the inertia reel mechanism. Allow the reel to retract the belt somewhat and engage the buckle, then tighten the belt against the child-restraint system. The retraction mechanism is now locked.

56 Transporting children safely

The belt cannot be extracted further. Always observe the installation instructions provided by the manufacturer of the child-restraint system.

To unlock the safety belt

Release the safety belt, remove the child seat and retract the safety belt to its end position on the belt retractor.

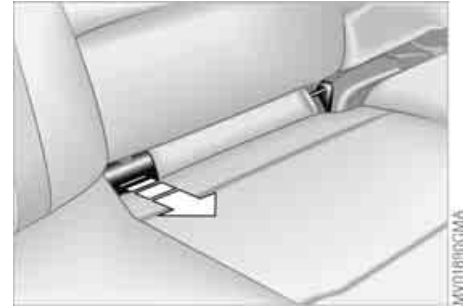

LATCH child-restraint mounting system

LATCH: Lower Anchors and Tethers for CHildren

The left and right rear seats are both equipped with a LATCH child-restraint mounting system.

The LATCH anchorage points may be identified by symbols.

Remove the cover from the outside mount by pulling forward. When reinstalling ensure that the recess is on the top.



With through-loading system: tilt the backrest halfway forward to make the cover easier to remove, refer to page [104](#).

The illustration is an example showing the mounts for a LATCH child-restraint mounting system at the right rear.



Always follow all manufacturer's instructions and observe all safety precautions when installing the LATCH child-restraint mounting system. ◀

How the system functions

No doubt you have reflected at one time or another on how great it would be if you could permanently configure your vehicle's various features and adjustments to mirror your own individual preferences. In engineering your vehicle, BMW has provided for a number of options for personal adjustment that can be programmed into your vehicle at your BMW center.

The available configuration data fall into two categories, according to whether their primary orientation is the vehicle – Vehicle Memory – or the individual – Key Memory. Provided that each person has a separate remote-control key, you can have your BMW center enter adjustment data for as many as four different individuals into the system.

The system then relies on a bilateral data exchange to identify the individual user and executes the selected settings whenever the remote control unit is used to disengage the door locks.

**Distinguishing between keys**

Color-coded decals have been provided to help you distinguish individual keys with different settings.

What the system can do

Your BMW center can provide you with details on the capabilities of the Vehicle Memory and Key Memory systems.



You will see this symbol throughout the Owner's Manual. It is to remind you at appropriate places of the settings that are available to you. ◀

Examples for Vehicle Memory:

- ▷ Various signals as acknowledgment when locking or unlocking your vehicle, refer to pages 29, 31

- ▷ Activates/deactivates the 'Follow me home' function, refer to page 85
- ▷ Activates/deactivates daytime driving lamps, refer to page 85
- ▷ Sets the units of measure for displaying time, outside temperature, distance traveled and fuel consumption in the instrument cluster
- ▷ When you shift into Reverse, an acoustic signal indicates that PDC has been activated, refer to page 80
- ▷ Switches on rear window defroster automatically, refer to pages 92, 97
- ▷ Activates/deactivates various alarm system functions, refer to page 37
- ▷ After giving an ice warning, the onboard computer display returns to the previous setting, refer to page 78.

Examples for Key Memory:

- ▷ Unlocks driver's door first, then the vehicle's remaining locks, refer to page 29
- ▷ Locks the vehicle automatically after you start off, refer to page 32
- ▷ Automatically adjusts the driver's seat to the personal programmed settings when the vehicle is unlocked, refer to page 47
- ▷ Automatic tilting of the passenger-side mirror, refer to Automatic curb monitor, page 48.

Ignition lock

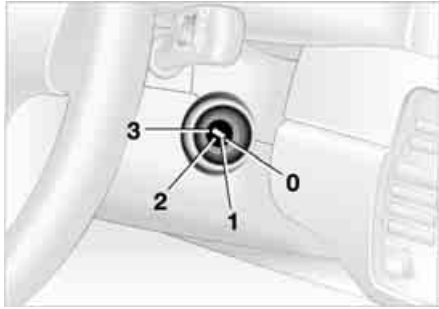

Ignition key positions

- 0 Steering locked
- 1 Steering unlocked
- 2 Ignition switched on
- 3 Starting the engine

 Vehicles with automatic transmission:

Do not move the selector lever from position P until the engine is running – ignition key position 2.

Your vehicle is equipped with an interlock. Therefore, the ignition key cannot be turned to position 0 or removed until the selector lever is in position P. ◀

 Vehicles with manual transmission:

Step on the clutch when starting the vehicle. A lockout prevents the engine from starting if the clutch is not depressed. ◀

Steering locked

The key can only be inserted and removed in this position.

After removing the key, turn the steering wheel slightly to the left or right until the lock engages.

If the key is not removed, an acoustic signal is sounded after the driver's door has been opened.

Steering unlocked

You will find that it is often easier to turn the ignition key from position 0 to position 1 when you move the steering wheel slightly to help disengage the lock.

Individual electrical accessories are ready for operation.

Starting the engine

 Do not allow the engine to warm up by leaving it running while the vehicle remains stationary. Instead, drive off immediately at a moderate engine speed. ◀

 Do not allow the engine to run in enclosed spaces. Otherwise, breathing the exhaust fumes can lead to unconsciousness and death. The exhaust gases contain carbon monoxide, an odorless and colorless, but highly toxic gas. Do not leave the vehicle unattended with the engine running. An unattended vehicle with a running engine represents a safety hazard. When driving, standing at idle or parking the vehicle, take care to avoid contact between the hot exhaust system and flammable materials – grass, hay, leaves, etc. Such contact could lead to a fire, resulting in serious personal injury and property damage. ◀

Start the engine. Do not press the accelerator pedal.

 Do not actuate the starter for too short a time, but do not actuate it for more than approx. 20 seconds. Release the ignition key immediately when the engine starts. ◀

60 Starting the engine

If the engine does not start on the first attempt – if it is very hot or cold, for instance:

- ▷ Press the accelerator pedal halfway down while engaging the starter.

Cold starts at extremely low temperatures below +5 °F / -15 °C and at altitudes of over approx. 3,300 ft / 1,000 m:

- ▷ On the first start attempt, it may be necessary to engage the starter for a longer period, but no longer than 20 seconds
- ▷ Press the accelerator pedal halfway down while engaging the starter.

 Extended starting attempts, characterized by excessively frequent or long periods with the starter engaged can damage the catalytic converter. ◀

Engine idle speed is controlled by the engine computer system. Increased speeds at start-up are normal and should decrease as the engine warms up. If engine speed does not decrease, service is required.

To prevent the battery from discharging, always deactivate electrical devices that are not in use. Switch the ignition off when the vehicle is not being driven.

Manual transmission

1. Engage the parking brake
2. Gearshift lever in idling position
3. Depress the clutch pedal.
If the clutch pedal is not depressed, the engine cannot be started
4. Start the engine.

Automatic transmission

1. Depress footbrake
2. Place the selector lever in position P or N
3. Start the engine.

 To prevent the vehicle from starting off on its own, always move the selector lever to position P and engage the parking brake before leaving your vehicle with the engine running.

Do not leave the vehicle unattended with the engine running. An unattended vehicle with a running engine represents a safety hazard. ◀

Sequential manual gearbox SMG

1. Depress footbrake
2. Move selector lever into position N
3. Start the engine.

 If the engine does not start, reengage the gear last selected, refer to the gear indicator in the display, and move the selector lever into neutral position N again.

The gearbox is automatically taken out of gear if the driver's door is opened while the engine is running and the driver does not actuate the pedals, the shift paddles or the selector lever. This is accompanied by a warning tone and the flashing gear indicator. The gear display N appears in the instrument cluster. ◀

 Before exiting the vehicle with the engine running, move the selector lever into position N and apply the parking brake.

Do not leave the vehicle unattended with the engine running. An unattended vehicle with a running engine represents a safety hazard. ◀

Switching off the engine



You should never remove the ignition key when the vehicle is in motion, as the steering lock could engage.

When you leave the vehicle, always remove the ignition key and engage the steering lock.

Always engage the parking brake when parking on slopes and inclined surfaces. Engaging a gear may not provide adequate resistance to rolling. ◀

Vehicles with manual transmission

Turn the ignition key to position 1 or 0.

Automatic transmission

Move the selector lever into position P, and turn the ignition key to position 1 or 0.

SMG gearbox

If you turn the ignition key to position 1 or 0 with the selector lever in position R, or in sequential mode, a gear automatically remains engaged.

If you turn the ignition key to position 1 or 0 with the selector lever in neutral position N, a warning tone and the flashing gear indicator in the display remind you that no gear is engaged to secure the vehicle against rolling.

The warning stops after approx. 9 seconds.

Parking brake

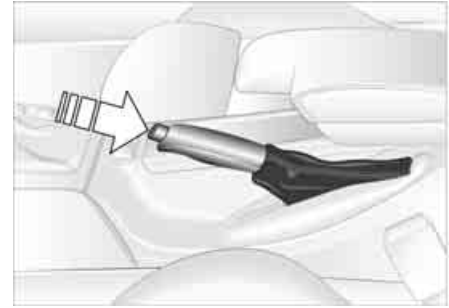

The parking brake is designed primarily to prevent the vehicle from rolling when it is parked. It operates on the rear wheels.

To engage

The detent engages automatically, and the indicator lamp in the instrument cluster comes on when the ignition key is in position 2, refer to page 18.

To release

Pull up slightly on the lever, press the button and lower the lever.

62 Parking brake

 If exceptional circumstances make it necessary to engage the parking brake while the vehicle is in motion, do not pull it with excessive pressure. Keep your thumb pressed against the release button while carefully pulling the lever up.

Excessive pressure can lead to over-braking and loss of traction – fishtailing – at the rear axle.

The brake lamps do not come on when the parking brake is engaged.

Vehicles with manual or SMG gearbox: Engage the parking brake when parking on downhill roads, since engaging a gear may not provide adequate resistance to rolling, not even in first or reverse gear.

Vehicles with automatic transmission: place the selector lever in Park. ◀

 To avoid corrosion and one-sided braking, apply the parking brake from time to time when coasting to a standstill – at a traffic signal, for example – provided that it is safe to do so. ◀

Manual transmission

 Do not hold the vehicle in place on slopes by slipping or 'riding' the clutch. Use the parking brake instead. Riding the clutch leads to severe and premature clutch wear. ◀

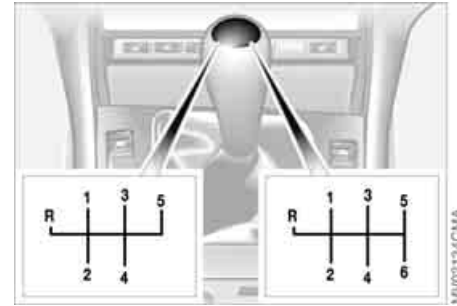

6-speed transmission*

When changing gear in the 5th/6th gear plane, be sure to press the gearshift lever to the right to prevent inadvertently shifting to a gear of the 3rd/4th gear plane.

Reverse

Select only when the vehicle is stationary. Press the shift lever to the left to overcome the slight resistance.

As you do this, the backup lamps will light up automatically when the ignition key is in position 2.

Sequential manual gearbox SMG*

The concept

The sequential manual gearbox SMG is an automated manual gearbox with which clutching and shifting is assumed by an electro-hydraulic system.

The SMG is operated via the selector lever in the center console and two shift paddles on the steering wheel.

It offers the following functions:

- ▷ Sequential mode: manual mode
- ▷ Drive mode: automatic operation
- ▷ Ability to choose between two different driving programs: Standard, Sport
- ▷ Operating safety through protection against misshifting
- ▷ Automatic upshifts and downshifts in the drive mode
- ▷ Automatic downshifts at minimum engine rpm
- ▷ Kickdown function in the drive mode.
- ▷ Acceleration assistant, refer to page 66



Selector lever positions

The current selector lever position is indicated by a light-emitting diode in the center console.

R: Reverse

N: Neutral

Position for forward driving with one-touch functions:

Sequential mode

+ : manual upshifts

- : manual downshifts

D: drive mode.

The SMG is ready for operation in ignition key position 2.

▶ The gearbox is automatically placed in neutral gear if the driver's door is opened while the engine is running and the driver does not actuate the pedals, the shift paddles or the selector lever.

This is accompanied by an acoustic signal and the flashing gear indicator. The gear display N appears in the instrument cluster.

A driving position can only be engaged when the driver's door is closed. When the vehicle is unlocked, a buzzer in the area of the transmission indicates that the system is ready for operation. ◀

Shiftlock

When the car is at a standstill, a safety function requires you to depress the brake pedal if you want to move the selector lever from the neutral position N to a driving position.

Driving precautions

⚠ Use enough acceleration to pull away speedily when moving off on an uphill gradient. Never try to prevent the car from rolling back on an uphill gradient by depressing the accelerator pedal; always apply the handbrake. Otherwise you could overheat the SMG gearbox. ◀

64 Sequential manual gearbox SMG*

R Reverse

Select only when the vehicle is stationary.

N Neutral

Always engage before starting the engine, refer to Starting the engine on page 60.

Sequential mode

Each time the engine is started, the sequential mode is activated as soon as you move the selector lever into the forward driving position while the brake is depressed.

The gears are shifted via the shift paddles or the selector lever.

It is also possible to drive off in second gear, e.g. on snow-covered roads.

D Drive mode

In the drive mode all forward gears are shifted automatically.

To switch from sequential to drive mode: tap the selector lever to the right toward D.

For rapid acceleration, e.g. during passing, depress the accelerator pedal completely: kickdown.

To switch back to sequential mode: tap the selector lever again to the right toward D or change the current gear via the shift paddles or the selector lever.

Kickdown

You can achieve maximum acceleration using kickdown.

Depress the accelerator pedal past the increased resistance point at the full-throttle position.



Shifting gears

With the selector lever:

- ▷ To upshift, tap the selector lever toward +
- ▷ To downshift, tap the lever toward –.

With the shift paddles on the steering wheel:

- ▷ To upshift, pull one of the shift paddles
- ▷ To downshift, push the paddle.

You accelerate from higher gears, e.g. during passing, by manually downshifting.

In the following situations, the SMG in the sequential mode assists you:

- ▷ Upshifts and downshifts are only executed at appropriate combinations of engine rpm and vehicle speed. For

Sequential manual gearbox SMG*

instance, downshifts that would result in excessive engine speed cannot be executed

- ▷ When you brake the car to a stop, the transmission automatically shifts down to first gear
- ▷ As speed diminishes, the transmission will shift down automatically, without any action on your part, just before the vehicle slows to below each gear's minimum speed.



Available displays

R N 1 2 3 4 5 6

D1 D2 D3 D4 D5 D6

The currently engaged gear, the selected mode, and any malfunctions are displayed in the instrument cluster.

Indicator lamp



If the indicator lamp comes on, there is a malfunction in the transmission system.

All selector lever positions can still be engaged, but in the forward driving positions only certain gears are actually available when the vehicle is driven.

Avoid extreme loads and proceed to the nearest BMW center.

For information on jump-starting and towing the vehicle, refer to page 147.

Warning tone

An acoustic signal sounds if the SMG gearbox overheats; if possible you should either stop or increase your pull-away speed so that the system can cool down.



 Do not use the acceleration assistant too frequently as this could cause premature wear of the components. ◀

1. Activate the Sport program
2. Press and hold the DSC button, refer to page 81, for more than three seconds
3. Quickly press the accelerator pedal down fully: kickdown. The optimum rpm for driving off will be adjusted.

Sport program

You can choose between two driving programs: smoothly dynamic or Sport. With the Sport program, gearshifts are faster in sequential mode and the shift points are adapted in drive mode.

To activate the Sport program: press the SPORT button. The LED in the button lights up.

Acceleration assistant

The acceleration assistant permits optimum racing-style acceleration when you are driving off on roads with good grip.

 To maintain vehicle stability, always drive with the DSC activated whenever possible. ◀

Automatic transmission with Steptronic*

In addition to the fully automatic operation, you can also shift gears manually with Steptronic, refer to page 68.

When you move the selector lever from the D position to the left into the M/S range, the performance-oriented shift programs of the automatic transmission are engaged. Steptronic enters the manual selection mode and executes the desired shift whenever you tap the selector lever in the direction indicated by + or -. Whenever you want to use the automatic mode again, just shift the selector lever toward the right to position D.

Under normal operating conditions, fuel consumption is lowest when driving in position D.

Selector lever positions

P R N D M/S + -

Starting the engine

The engine can only be started in selector lever positions P – for Park – or N – for Neutral.



Range selection

A catch prevents inadvertent movement of the selector lever to positions R and P. To deactivate the catch, press the button on the front of the selector lever knob, see arrow.

 While the vehicle is stationary and before shifting out of Park or Neutral, depress the footbrake in order to disengage the selector lever's lock mechanism – Shiftlock. ◀



Hold the footbrake down until starting off. Otherwise the vehicle will 'creep' when a drive position is engaged. To prevent the vehicle from starting off on its own, always move the selector lever to position P and engage the parking brake before leaving your vehicle with the engine running. Do not leave the vehicle unattended with the engine running. An unattended vehicle with a running engine represents a safety hazard. ◀

P Park

Select only when the vehicle is stationary. Transmission locks to prevent rear wheels from turning.

R Reverse

Select only when the vehicle is stationary.

N Neutral

Engage this, for example, when you are driving through a car wash. The vehicle can roll.

D Drive, automatic shift program

This position is designed for driving under all normal operating conditions. All forward gears are available.

Kickdown

You can achieve maximum road performance using kickdown.

Depress the accelerator pedal past the increased resistance point at the full-throttle position.

**M/S manual operation and Sport program**

When you move the selector lever from the D position to the left into the M/S range, the sport program is activated, indicated by the letters SD in the instrument cluster. The M/S mode is recommended for performance-oriented driving. Steptronic enters the manual selection mode and executes the desired shift whenever you tap the selector lever in the direction indicated by + or –.

This mode allows you to execute upshifts manually by tapping the lever toward +, while downshifts are selected by tapping in the – direction. The displays M1 through M5 appear in the instrument cluster.

The transmission will only execute upshifts and downshifts that will result in an appropriate combination of vehicle speed and engine rpm. For instance, downshifts that would result in excessive engine speed are not executed. The desired, then the actual gear, briefly appear in the instrument cluster.

Whenever you want to use the automatic mode again, just shift the selector lever toward the right to position D.

Shifting from M/S to the selector lever positions P, R and N is possible only by going through D.

 To accelerate quickly in the manual mode for maneuvers such as passing another vehicle, shift down manually or employ the kickdown mode. ◀

Shifting from M/S to the selector lever positions P, R and N is possible only by going through D.

Automatic transmission with Steptronic*



If the indicator lamp goes out after a few seconds, normal transmission performance has been restored. You may continue to drive as usual.

If the indicator lamp does not go out, you can place the selector lever in all positions. However, the vehicle will now only operate in 3rd and 4th gear.

If this happens, avoid extreme engine loads and consult the nearest authorized BMW center.

Available displays

P R N D SD M1 M2 M3 M4 M5

The selector lever position or gear currently engaged in the manual mode is displayed.

Electronic transmission control module



If the indicator lamp comes on, there is a malfunction in the transmission system.

Bring the vehicle to a stop. Move the transmission selector lever to P. Set the parking brake and turn the engine off – ignition key to position 0.

Wait a few seconds, then start the engine.



Never work in the engine compartment when a drive gear – forward or reverse – is engaged. If you do this, the vehicle could move. ◀

For towing or jump-starting, refer to the information beginning on page [147](#).

70 Turn signal indicator/Headlamp flasher

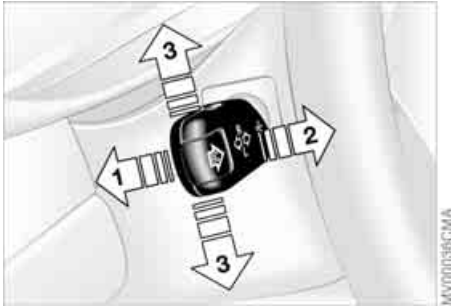

- 1 High beams
- 2 Headlamp flasher
- 3 Turn signal indicators

To signal briefly

Press the lever up to the detent but not beyond. It then returns to the center position when released.

 If the flashing of the indicator lamp and the clicking from the relay are both faster than usual, one of the turn signal indicators has failed. ◀

Washer/wiper system/Rain sensor*



- 0 Wipers retracted
- 1 Intermittent mode or rain sensor
- 2 Normal wiper speed
- 3 Fast wiper speed
- 4 Brief wipe
- 5 Rotary dial for control of the wipe interval or the sensitivity of the rain sensor

Intermittent mode

Not on vehicles with rain sensor.

You can select any of four sweep intervals with rotary dial 5.

In addition, the wipe interval varies automatically depending on road speed.

Rain sensor

The rain sensor is positioned on the windshield, directly behind the interior rearview mirror.

To activate the rain sensor:

- ▷ With the ignition key in position 1 or 2, move the lever to position 1. The wipers will make at least one sweep across the windshield. You can leave the lever in position 1 at all times. With the ignition key in position 1 or 2, all you then need to do to activate the rain sensor is to
 - ▷ turn rotary dial 5 upward or
 - ▷ clean windshield 1, refer to page 72.

To adjust the sensitivity of the rain sensor: turn rotary dial 5.

To switch off the rain sensor:

Return lever to position 0.



Turn the rain sensor off in automatic car washes. Failure to do so could result in damage caused by undesired wiper activation. ◀

Normal wiper speed

When the vehicle is stationary, the wipers switch automatically to intermittent wipe – not on vehicles with rain sensor.

Fast wiper speed

When the vehicle is stationary, the wipers revert to operate at normal speed – not on vehicles with rain sensor.



Cleaning windshield and headlamps*

0 Wipers retracted

1 Clean windshield and headlamps*

 Do not use the washers if there is any danger that the fluid will freeze on the windshield, as your vision could be obscured. Always use a windshield washer antifreeze in cold weather. Refer to page 126. Do not use the washers when the reservoir is empty, as this could cause damage to the washer pump. ◀

The system sprays washer fluid against the windshield and activates the wipers for a brief period.

When the vehicle's lighting system is switched on, the headlamps will also be cleaned at reasonable intervals.

Windshield washer nozzles

The windshield washer nozzles are heated automatically* when the ignition key is in position 2.

Cruise control*

You can store and automatically maintain any desired vehicle speed above approx. 20 mph / 30 km/h.

The cruise control is available whenever the engine is running and the system has been activated.

To activate the system

I/O

In ignition key position 2:

Press the button in the steering wheel. The indicator lamp in the instrument cluster comes on, refer to page 20. You can now use the cruise control.

 Do not use cruise control on twisting roads, when high traffic density prevents driving at a constant speed, or when the road surface is slick – snow, rain, ice – or loose – rocks or gravel, sand. ◀

To deactivate the system

I/O

Press button as often as needed until the indicator lamp in the instrument cluster goes out.

Cruise control is also deactivated when the ignition key is in position 0.

Cruise control*

The speed stored in memory is deleted.

To store and maintain speed or to accelerate



Press button + briefly:

The system registers and maintains the current vehicle speed. Every time you tap the button, the speed increases by approx. 0.6 mph / 1 km/h.

Press and hold button +:

The vehicle accelerates without pressure on the accelerator pedal. When you release the button, the system stores and maintains the current speed.

 If on a downhill gradient the engine braking effect is not sufficient, the controlled speed can be exceeded. Speed can drop on uphill grades if the engine output is insufficient. ◀

To decelerate



Press button – briefly:

If you are already driving with activated cruise control, the speed is decreased by approx. 0.6 mph / 1 km/h every time you tap the button.

Press and hold button –:

With the cruise control active, the system automatically reduces the throttle opening to slow the vehicle. When you release the button, the system stores and maintains the current speed.

To interrupt the cruise control



When the system is activated, press the button. The indicator lamp stays on. You can use the cruise control again whenever you want by calling up the speed that was stored last.

In addition, cruise control is interrupted automatically:

- ▷ When the brakes are applied
- ▷ When you apply pressure to the clutch pedal, or when you move the automatic transmission selector lever from D to N

- ▷ If you exceed or fall below the programmed speed for an extended period – by depressing the accelerator, for example.

To recall the stored setting



Press button:

The vehicle accelerates to and maintains the last speed stored.



- 1 Odometer
- 2 Trip odometer

Odometer

You can activate the displays shown in the illustration with the ignition key in position 0 by pressing the left button in the instrument cluster.

Trip odometer

To reset the trip odometer to zero, press the left button with the ignition key in position 1 or higher.



Do not operate the engine with the needle in the red overspeed zone of the gauge.

To protect the engine, the fuel supply is interrupted when you approach this sector.



Indicates the current fuel consumption in mpg – in liters/100 km on Canadian models. You can check your current driving style to see whether it is conducive to economy and minimum exhaust emissions.

When the vehicle is stationary, the display goes to Maximum – zero on Canadian models.

Fuel gauge



Once the indicator lamp stays on continuously, there are still approx. 2 gallons/8 liters of fuel in the fuel tank. Fuel tank capacity approx. 16.6 gallons/63 liters.

Certain operating conditions, such as those encountered in mountainous areas, may cause the needle to fluctuate slightly.

 Fill the fuel tank before it is completely empty. Driving to the last drop of fuel can prevent the engine from operating properly and result in damage. ◀

When you switch on the ignition, the indicator lamp lights up briefly as an operation check.

Engine coolant temperature gauge



To check coolant level, refer to page 128.

Blue

The engine is still cold. Drive at moderate engine and vehicle speeds.

Between the blue and red zones

Normal operating range. The needle may rise as far as the edge of the red sector during normal operation.

Red

When you switch on the ignition, the warning lamp comes on briefly as an operation check.

If the lamp comes on during normal vehicle operation: the engine has overheated. Stop and switch the engine off immediately and allow it to cool down.

76 Service interval display



A flashing message and a "-" in front of the number mean that the service interval has already been exceeded by the distance shown on the display. Please contact your BMW center for an appointment.

Remaining distance to next service

The displays shown in the illustration appear for a few seconds when the ignition key is in position 1 or higher or after the engine is started.

The next service due appears with the message OIL SERVICE or INSPECTION, together with the distance remaining in miles – in kilometers in Canada – before the next scheduled service.

The computer bases its calculations of the remaining distance on the preceding driving style.

Check Control

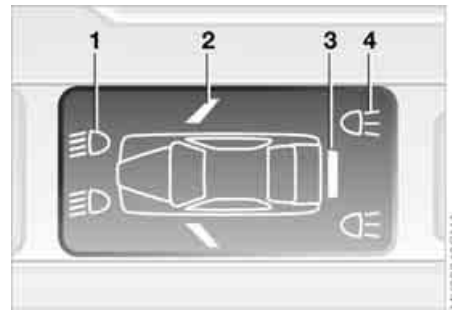

When the ignition key is in position 2, the following information and/or conditions are indicated using symbols until the conditions have been corrected.

- 1 Check the low beams and high beams, as well as the parking lamps
- 2 Door open
- 3 Luggage compartment lid open
- 4 Check tail or brake lamps

When you open the driver's door after having turned the ignition key to position 0, you will hear an acoustic signal for a few seconds to remind you that the lamps have not been switched off.

Clock

If you wish to have a permanent time display, you can make this adjustment in the radio display, refer to the Owner's Manual for Radio.

You can adjust the clock and the time display in the car radio as follows.



Every time you press the button, the clock display alternates between the 12-hour and 24-hour mode.

In ignition key position 0: the time is displayed for a few seconds after you press the left button, refer to Odometer on page 74.

Setting

 Before the clock can be set, the time must be showing in the instrument cluster display. ◀

With the ignition key in position 1 or higher.

To set ahead: turn the right button to the right.

To set back: turn the right button to the left.

The adjustment speed will increase the longer you continue to hold the right button.

To change the display mode: press the right button briefly.

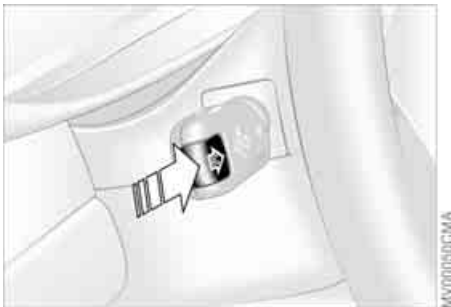

When the ignition key is in position 1 and higher, the last active setting is displayed.



Mode selection

With the ignition key in position 1 or higher, you can use the onboard computer button BC in the turn signal lever to retrieve information from the computer for display in the instrument cluster.

Every time you tap the onboard computer button BC, the display changes to the next function in sequence.

Order of the displays:

- ▷ Clock
- ▷ Outside temperature
- ▷ Average fuel consumption
- ▷ Range
- ▷ Average speed.

Outside temperature

You can change the units of measure – °F/°C – for the outside temperature display by pressing the right-hand reset button in the instrument cluster while the temperature display is active. The units of measure – °F/°C – in the temperature display of the automatic climate control change automatically, refer to page 94.

Ice warning

If the outside temperature drops to about 37.5 °F/+3 °C, then the computer will automatically switch to a display of the outside temperature. In addition, a signal sounds as a warning and the display flashes for a brief period.

Computer



After giving an ice warning, the display returns to the previous setting. ◀



The ice warning does not alter to the fact that surface ice can form at temperatures above 37.5 °F/+3 °C, on bridges or shaded road surfaces, for instance. ◀



Average fuel consumption

If you press the onboard computer button BC in the turn signal lever for longer while the average fuel consumption value is being displayed, a new consumption value is calculated from that point in time.



If you wish, you can have the average fuel consumption displayed in a different unit of measure. ◀

Range

The display shows a range estimate based on the available fuel. The amount of fuel remaining in the tank is measured, the estimated range is calculated taking into account the operating conditions over the last 20 miles/30 km.



It is important that you refuel when the cruising range falls below approx. 35 miles/50 kilometers. Otherwise, the engine cannot be guaranteed to operate properly and damage may result. ◀

Average speed

Any time spent when the vehicle is stationary and the engine is shut off is ignored for the calculation.

To reset the average speed: press the onboard computer button BC in the turn signal lever for approx. 2 seconds.

The concept

PDC assists you when you back into a parking space. Acoustic signals alert you to the momentary distance to an object behind your vehicle. For this purpose, four ultrasonic sensors in the rear bumper measure the distance to the next object. The monitoring range for the rear bumper's two corner sensors extends outward roughly 2 ft/60 cm, while the two centrally located sensors detect objects at distances of up to approx. 5 ft/1.50 meters.

 PDC is a parking aid that can identify objects if they are approached slowly, as is generally the case when parking. Avoid driving towards objects rapidly; due to underlying physical principles, the system may otherwise alert you too late for you to take evasive steps. ◀

The system starts to operate automatically approx. one second after you shift into Reverse or move the selector lever into the R position with the ignition key in position 2.

 Let this short period elapse before driving backwards. ◀

PDC is deactivated when you shift back out of Reverse.



You can have a signal set to confirm that the PDC has been activated. The signal then sounds when you shift into Reverse or move the selector lever into the R position. ◀

Acoustic signals

The distance to the nearest object is indicated by a tone sounding at various intervals. As the distance between vehicle and object decreases, the intervals between the tones become shorter. A continuous tone indicates the presence of an object less than 1 ft/30 cm away.

The warning signal is canceled after approx. three seconds if the distance to the object remains constant during this time – if you are moving parallel to a wall, for instance.

System malfunctions will be indicated by a continuous high-pitched tone when the system is activated the first time. Please have the problem fixed by your BMW center.



PDC does not replace the driver's personal responsibility for evaluating the distance between the vehicle and any objects. Even when sensors are involved, there is a blind spot in which objects cannot be detected. This applies especially in those cases where the system approaches the physical limits of ultrasonic measurement, as occurs with tow bars and trailer couplings, and in the vicinity of thin or wedge-shaped objects. Moreover, low objects that have already been detected – such as a curb edge – can disappear out of the detection range of the sensors before a continuous tone sounds.

Loud sources of sound from outside or inside the vehicle could drown out the PDC signal tone. ◀



Keep the sensors clean and free of ice or snow in order to ensure that they will continue to operate effectively.

Do not apply high pressure spray to the sensors for a prolonged period of time. Always maintain a distance of more than 4 in/10 cm. ◀

Dynamic Stability Control (DSC)

The concept

DSC supports vehicle stability, even in critical driving situations.

The DSC is operational every time you start the engine.

DSC incorporates the Dynamic Traction Control (DTC) and Cornering Brake Control (CBC) functions.

The vehicle will remain completely operational, however, without DSC. In the event of a fault, please consult your BMW center.



Indicator and warning lamps for Canadian models.



Indicator lamps



The indicator lamp in the instrument cluster goes out shortly after you switch on the ignition, refer to page 19.

- ▷ The indicator lamp flashes: DSC is actively controlling drive torque and braking intervention
- ▷ The indicator lamp stays lit: DSC has been switched off with the button; DTC and DBC are operational. DTC control intervention is not indicated.



The indicator lamp and the brake warning lamp continuously light up in yellow:



The DSC, DTC and DBC have been switched off manually or there is a system malfunction.



Deactivating the DSC/activating the DTC

Tap the DSC button; the indicator lamp comes on and stays on.

DSC is deactivated; DTC is operational.

In the following rare situations, it may prove useful to activate the DTC for a brief period:

- ▷ When rocking the vehicle or starting off in deep snow or on loose surfaces
- ▷ When driving on snow-covered grades, in deep snow, or on a snow-covered surface that has been packed down from being driven on
- ▷ When driving with snow chains.

Under these special circumstances traction is increased by deactivating the control systems that enhance traction under normal conditions.

Deactivating the DSC and the DTC

Press the DSC button as long as you need to until the indicator lamp and the yellow brake warning lamp light up, but no more than 10 seconds.

The systems for enhancing stability and traction are deactivated, and there is no active braking intervention or torque control.

 To maintain vehicle stability, always drive with the DSC activated whenever possible. ◀

Reactivating the DSC

Tap the button again; the indicator lamp or the indicator lamps will go out. DTC is deactivated.



The laws of physics cannot be repealed even with DSC. It will always be the driver's responsibility to drive in a manner that matches road conditions. This is why you should not use the additional safety margin the system provides as an excuse to take risks.

Whenever the DTC is activated, the DSC is switched off and DTC performs minor stabilizing intervention.

Do not make any modifications to the DSC system. Allow only authorized technicians to perform service procedures on the DSC. ◀

Flat Tire Monitor*

The concept

As you drive, the Flat Tire Monitor keeps track of pressure levels in all four tires. The system alerts you whenever the inflation pressure of a tire falls significantly below the pressure of another tire.

The system actually detects pressure loss by monitoring differences in the relative speeds of the four wheels. It interprets variations outside specified limits as severe pressure loss, and then responds by generating a warning.

Functional requirements

In order for the Flat Tire Monitor to learn the correct tire inflation pressure, please do the following:

1. Check the tire inflation pressures in all tires
2. Compare them with the tire inflation pressure table, refer to page 116, and correct them, if necessary
3. Initialize the system.

Flat Tire Monitor*

System limitations

 The Flat Tire Monitor cannot provide you with advance warning of sudden and severe tire damage caused by external factors and does not detect the balanced and very gradual pressure loss that takes place in all four tires over an extended period of time. ◀

On the other hand, the following situations can lead to a delayed detection of pressure loss and even to the system not functioning:

- ▷ Driving on snow-covered or slippery roads
- ▷ Performance-oriented driving: slip at the drive wheels, high levels of lateral acceleration
- ▷ When driving with snow chains, false warnings and undetected pressure losses may occur
- ▷ When driving with a space-saver spare tire, the Flat Tire Monitor cannot function.



Initializing the system

 Each time you correct the pressure in a tire, or change a wheel or tire, reinitialize the system immediately afterwards. This requires a bit of driving. ◀

1. Before driving off, start the engine but do not start driving
2. Press the button as long as you need to, but no more than 10 seconds, until the indicator lamp in the instrument cluster lights up in yellow for a few seconds
3. Drive off.

It takes a few minutes before the Flat Tire Monitor can detect a flat tire and issue a warning.

 When driving with snow chains or a space-saver spare tire, do not initialize the system. ◀

Flat tire

 The indicator lamp in the instrument cluster lights up red. This visual alert is accompanied by an acoustic warning signal.

1. Carefully reduce speed and come to a stop. Avoid sudden braking and steering maneuvers
2. Determine which wheel is damaged
- ▷ If this cannot be determined, contact your BMW center. ◀
3. Replace the damaged wheel, refer to Changing a wheel on page 141.

After replacing the damaged tire, initialize the system.

Vehicles with Run Flat tires:

1. Carefully reduce your speed to under 50 mph / 80 km/h. Avoid sudden braking and steering maneuvers. Do not exceed a speed of 50 mph / 80 km/h

 Because the sides of Run Flat tires are reinforced, a drop in inflation pressure usually cannot be detected from the outside, refer to Run Flat tires, page 120. ◀

2. To continue driving, follow the instructions under Driving with a damaged tire on page 120.

System malfunction

 The indicator lamp in the instrument cluster lights up yellow. The Flat Tire Monitor is malfunctioning or out of order. Please refer the problem to your BMW center.

Brake force display

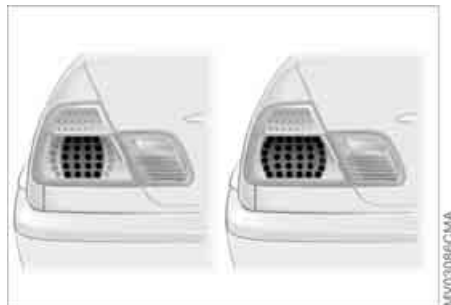

Brake force display indicates to the road users behind you how hard you are braking.

- ▷ Normal braking: the brake lamps among the rear lamps and the center brake lamp light up
- ▷ Hard braking or braking with ABS: in addition, the illuminated rear lamp surface is extended, refer to the picture.

Parking lamps/Low beams

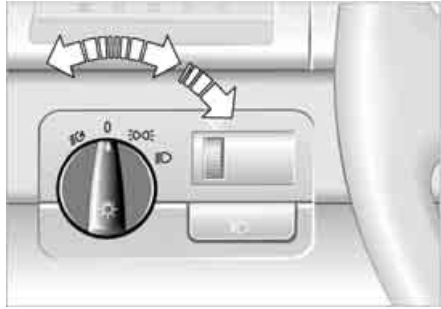

Parking lamps

 The front, rear and side vehicle lighting is switched on. You can use the parking lamps to signal the position of the vehicle when it is parked. For lighting on one side for parking as an additional feature, refer to page 87.

Low beams

 When the ignition is switched off while the low beams are on, the headlamps go out and only the parking lamps remain on.

Follow me home lamps

When you activate the headlamp flasher after parking the vehicle with the lights turned off, the low-beam headlamps will come on for a short time.

 You can also have this function deactivated. ◀

LIGHTS ON warning

When you open the driver's door after having turned the ignition key to position 0, you will hear an acoustic signal for a few seconds to remind you that the lamps have not been switched off.

Daytime driving lamps*

If you desire, the light switch can be left in the second position: when the ignition is switched off, the external lighting is also switched off.

 You can have the activation settings for the daytime driving lamps programmed on your vehicle. ◀

Automatic headlamp control*

 When the switch is set to this position, the system automatically activates and cancels the low beams in response to changes in ambient light, for example in tunnels, at dusk, and when it is raining or snowing.

 The low-beam headlamps remain on, regardless of the ambient light, when you switch on the fog lamps. ◀

 Automatic headlamp control cannot serve as a substitute for the driver's judgement in determining when the vehicle lights should be switched on. For example, the sensors are not able to detect fog. To avoid safety risks, you should respond to these kinds of low-visibility situations by switching the headlamps on manually. ◀

 You can have the sensitivity of your vehicle's automatic headlamp control adjusted. ◀

The concept

Adaptive headlights is a variable headlamp control system for dynamically illuminating the road. Depending on the steering angle and other factors the light from the headlamps follows the course of the road.

Activating Adaptive headlights

With the ignition key in position 2, turn the light switch to the automatic headlamp control position, refer to page 85. The LED next to the symbol lights up.

To avoid blinding oncoming traffic, adaptive headlights are

- ▷ not active while reversing,
- ▷ active only towards the front passenger side while the vehicle is at a standstill.

System malfunction

The LED next to the symbol for automatic headlamp control flashes. The adaptive headlight system is malfunctioning or out of order. Have the system checked as soon as possible.

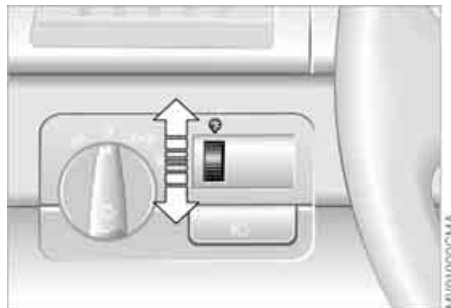
Instrument lighting

Turn the rotary dial to adjust the illumination intensity.

High beams/Standing lamps

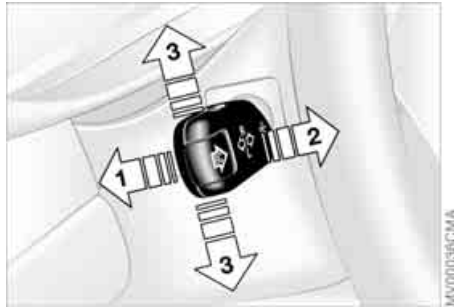

- 1 High beams
- 2 Headlamp flasher
- 3 Standing lamps

Standing lamps, left or right

As an additional feature, you can illuminate your vehicle on either side for parking:

With the ignition key in position 0, engage the lever in the appropriate turn-signal position.

Front fog lamps



Tap the button to switch on or off.

 The parking lamps or low-beam headlamps must be switched on. The green indicator lamp in the instrument cluster lights up to indicate that the front fog lamps are on.

 If the automatic headlamp control is on, the low beams will come on automatically whenever you activate the front fog lamps. ◀



The interior lamps operate automatically.

To switch the interior lamps on and off manually

Press button 1 briefly:

If you want the interior lamps to remain off all the time, press and hold the button for approx. 3 seconds.

Press the button briefly to revert to normal operation.

Front reading lamps*

Switch on and off with the button 2 adjacent to each lamp.

Rear reading lamps

Switch on and off with the button adjacent to each lamp.



In order to prevent battery discharge, all of the lamps in the vehicle are automatically switched off approx. 15 minutes after you turn the ignition key to position 0. ◀

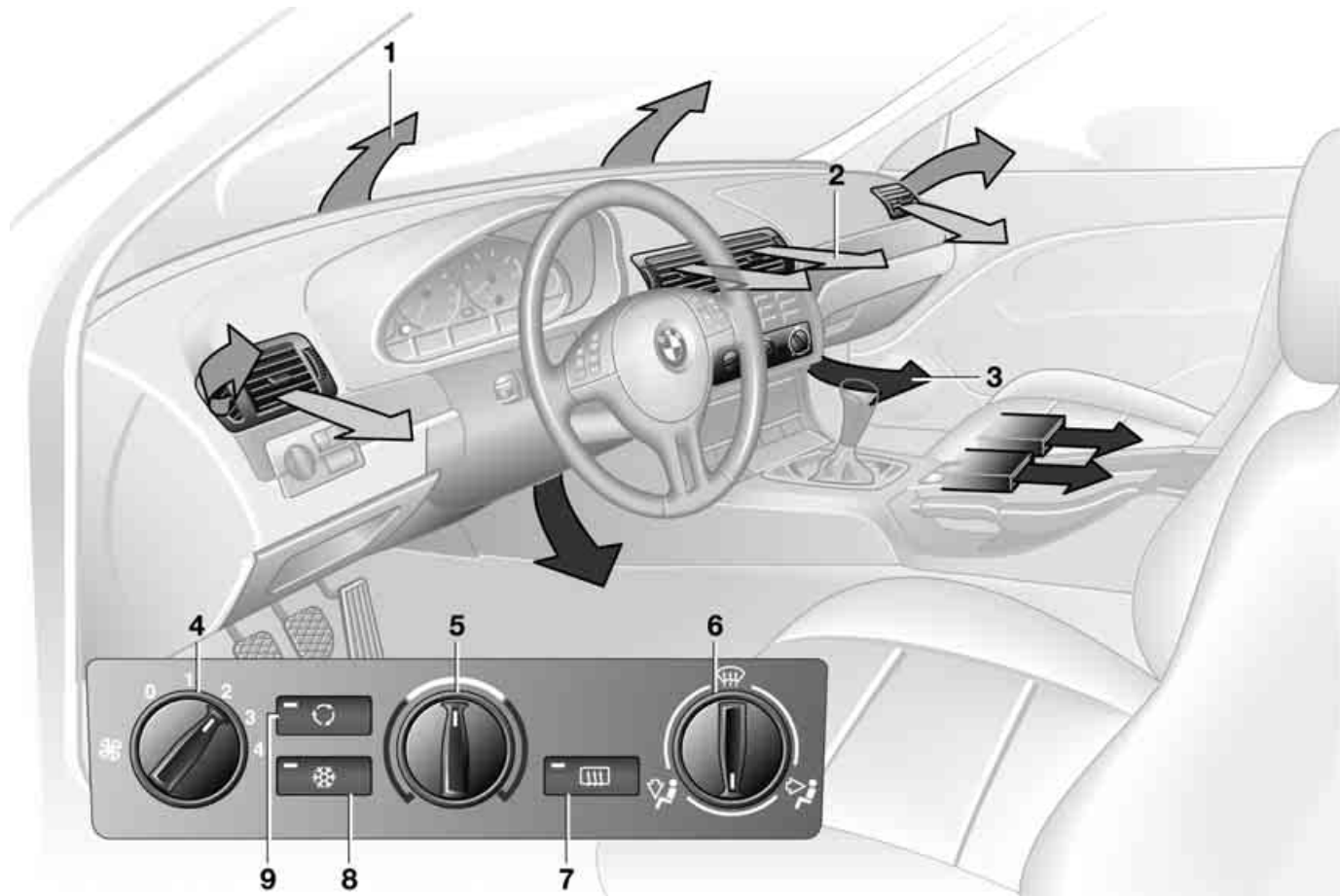

Air conditioning

- 1 Air onto the windshield and the side windows
- 2 Air for the upper body area [93](#)
- 3 Air to the footwell
- 4 Air supply/Blower [92](#)
- 5 Temperature [92](#)
- 6 Air distribution [92](#)
- 7 Rear window defroster [92](#)
- 8 Air conditioning [92](#)
- 9 Outside air/Recirculated-air mode [92](#)





Air supply/Blower

You can select blower speeds from 1 to 4. The heating and ventilation become more and more effective as the air supply settings are increased. In position 0, the blower and the heater are switched off. The outside air supply is blocked in position 0.

Temperature

In order to increase the temperature of the passenger compartment, turn to the right toward the red zone. The temperature of the incoming air is kept constant.

Air distribution

You can direct air to flow onto the windows , toward your upper body  or into the footwell . All intermediate settings are possible. In the  setting, there is a low flow of air onto the windows to keep them free of condensation.

Rear window defroster

When the rear window defroster is activated, the indicator lamp comes on. The rear window defroster switches off automatically after a short while.



You can have your vehicle programmed in such a way that the rear window defroster switches on automatically. This occurs within 5 minutes after starting the engine when outside temperatures are below approx. 39 °F / +4 °C. ◀

Air conditioning

The air is cooled and dehumidified and – depending on the temperature setting – rewarmed.

Depending on the weather, the windshield may fog over briefly when the engine is started. Air conditioning helps prevent the windows from fogging up.



Condensation forms during operation of the air conditioning system, which then exits under the vehicle. Traces of condensed water of this kind are thus normal. ◀

Outside air/Recirculated-air mode

You can respond to unpleasant external odors by temporarily blocking the supply of outside air. The system then recirculates the air currently within the vehicle.



If the windows should fog over in the recirculated-air mode, switch this mode off and increase the air supply as required. ◀

Air conditioning

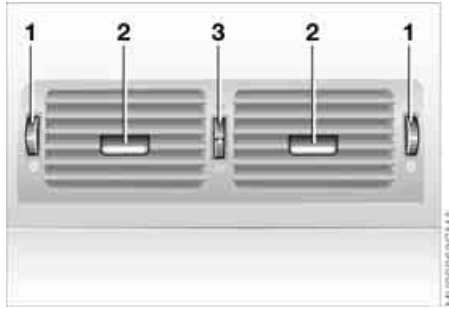

Microfilter

The built-in microfilter removes dust and pollen from the incoming air. Your BMW center will replace it during routine maintenance. A substantial reduction in airflow indicates that the filter needs to be replaced before scheduled maintenance.

Draft-free ventilation

You can adjust the blower controls for the upper body area to obtain the optimum airflow rates and directions for your personal requirements:

- 1 Rotary dials for infinitely variable opening and closing of the vent outlets
- 2 Levers for airflow direction
- 3 With the rotary dial, you can add more or less cool air to the air coming from the outlets for the upper body area:
 - ▷ Turn toward blue – cooler.
 - ▷ Turn toward red – warmer.



To defrost windows and remove condensation

1. Set the blower speed rotary control for the airflow rate to position 4
2. Turn the rotary temperature control completely to the right to the red zone
3. Turn the rotary control for air distribution to position 
4. Switch on the rear window defroster to defrost the rear window.

94 Automatic climate control*

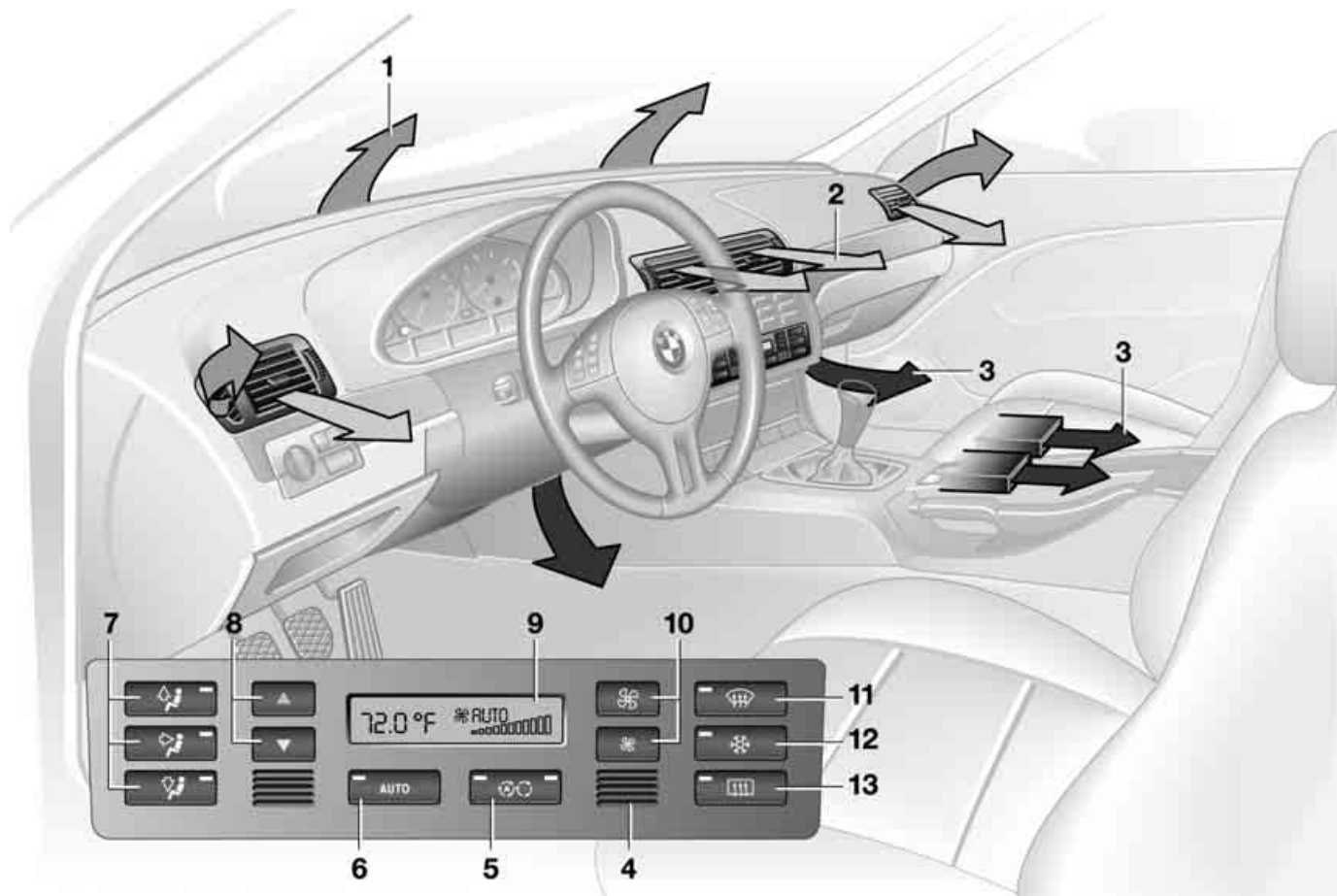

Automatic climate control*

- 1 Air onto the windshield and the side windows
- 2 Air for the upper body area [97](#)
- 3 Air to the footwell
- 4 Air inlet for interior temperature sensor – please keep clear and unobstructed
- 5 Outside air/Automatic recirculated-air control (AUC)/Recirculated air [97](#)
- 6 Automatic air distribution and supply [96](#)
- 7 Individual air distribution [96](#)
- 8 Temperature [96](#)
- 9 Display for temperature [96](#) and air supply [96](#)
- 10 Air supply/Blower [96](#)
- 11 To defrost windows and remove condensation [96](#)
- 12 Air conditioning [96](#)
- 13 Rear window defroster [97](#)

Tips for pleasant driving

Use the automatic mode – switch on with AUTO button 6. Select an interior temperature that is comfortable for you.

Detailed setting options are described for you in the following section.



You can make the settings of your vehicle in such a manner that, when you unlock the vehicle with the remote control of your personal key, your own personalized setting for the automatic climate control is initiated. ◀



AUTO program

The AUTO program adjusts the air supply and the air distribution to the windshield and the side windows, towards the upper body and to the footwells, and in addition adapts the temperature to external influences: e.g. summer, winter.

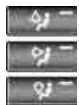
The cooling function is automatically switched on when you are using the AUTO program.

Individual air distribution

You can cancel the AUTO program by selecting specific distribution patterns to suit your own individual requirements.

While the AUTO program is deactivated, the automatic airflow control remains in operation. Air flows onto the windows , toward the upper body , and into the footwell . You can switch the automatic distribution of air back on by selecting the AUTO button.

Temperature

The interior temperature that appears in the display panel is a general figure intended for reference purposes. We recommend 72 °F / +22 °C as a comfortable setting, even if the air conditioning is on. When you start the vehicle, the system ensures that the selected temperature is achieved as quickly as possible regardless of the season. It then maintains this temperature.

To select the units of measure °F / °C of the temperature display, refer to page 78.

Air supply/Blower

By pressing the upper or lower button, you can vary the air supply. This deactivates the automatic control of the air supply, AUTO disappears from the display panel. Nev-

ertheless, the automatic air distribution remains unchanged. You can reactivate the automatic air distribution mode by selecting the AUTO button.

When the lowest blower speed is set and you press the lower button, all of the displays are canceled: the blower, heating and air conditioner are switched off. The outside air supply is blocked. You can reactivate the system by pressing any button for the automatic climate control.

To defrost windows and remove condensation

This program quickly removes ice and condensation from the windshield and the side windows.

Air conditioning

The air is cooled and dehumidified and – depending on the temperature setting – rewarmed.

Depending on the weather, the windshield may fog over briefly when the engine is started. Air conditioning helps prevent the windows from fogging up.

The cooling function is automatically switched on when you are using the AUTO program.

Automatic climate control*

 Condensation forms during operation of the air conditioning system, which then exits under the vehicle. Traces of condensed water on the ground underneath the vehicle are thus normal. ◀

Outside air/Automatic recirculated-air control (AUC)/ Recirculated air

 You can respond to unpleasant external odors or pollutants by temporarily stopping the flow of outside air. The system then recirculates the air currently within the vehicle.

Press the button repeatedly to select one of three different operating modes.

- ▷ Indicator lamps off: outside airflow is on
- ▷ Left-hand indicator lamp on – AUC mode: the system recognizes pollutants in the outside air and blocks the flow of air when necessary. The system then recirculates the air currently within the vehicle. Depending on the air quality, the automatic system then switches back and forth between outside air supply and recirculation of the air within the vehicle
- ▷ Right-hand indicator lamp on: the flow of external air into the vehicle is

permanently blocked. The system then recirculates the air currently within the vehicle.

 If the windows should fog over in the recirculated-air mode, switch this mode off and increase the air supply as required. ◀

Rear window defroster

 When the rear window defroster is activated, the indicator lamp comes on. The rear window defroster switches off automatically after a short while.

 You can have your vehicle programmed in such a way that the rear window defroster switches on automatically. This occurs within 5 minutes after starting the engine when outside temperatures are below approx. 39 °F / +4 °C. ◀

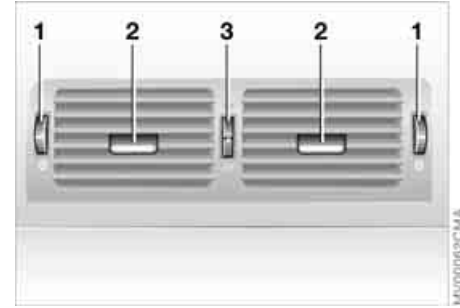

Draft-free ventilation

You can adjust the blower controls for the upper body area to obtain the optimum airflow rates and directions for your personal requirements:

- 1 Rotary dials for infinitely variable opening and closing of the vent outlets
- 2 Levers for airflow direction
- 3 With the rotary dial, you can add more or less cool air to the air coming from the outlets for the upper body area:
 - ▷ Turn toward blue – cooler.
 - ▷ Turn toward red – warmer.

Microfilter/activated-charcoal filter

The built-in microfilter removes dust and pollen from the incoming air. The activated-charcoal filter provides additional protection by filtering gaseous pollutants from the outside air. Your BMW center replaces this combined filter as a standard part of your scheduled maintenance. A substantial reduction in airflow indicates that the filter needs to be replaced before scheduled maintenance.

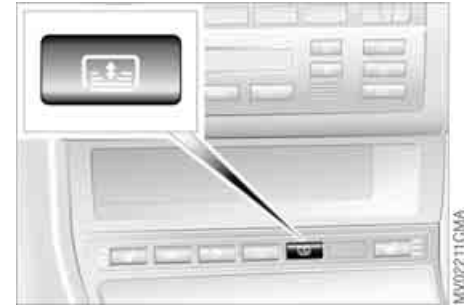

To activate, press the button briefly with the ignition key in position 1 or higher.

The illustration depicts the arrangement of the buttons if the vehicle is fully equipped. The arrangement may vary, depending on the equipment actually installed.

Premium sound system*



Harman Kardon premium sound system

The system creates the acoustic impression of a much larger passenger compartment accompanied by improved stereophonic sound at all seating positions.

The system responds to poor reception conditions by repeatedly alternating between the stereo and monophonic modes. You should then switch the system off.

Glove compartment

99

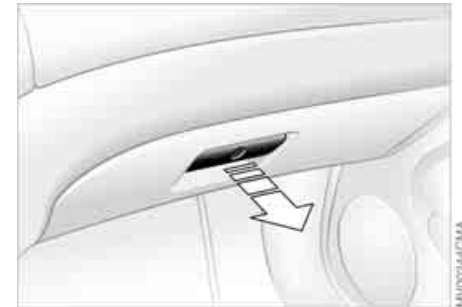

To open

Pull the handle. The lamp in the glove compartment will come on.

To close

Fold the cover up.

 To prevent injury in the event of an accident, close the glove compartment immediately after use. ◀

To lock

Lock with one of the master keys. A master key will also be required to unlock the glove compartment.

 If – for example for valet parking – you turn over only your spare key, refer to page 28, then access to the locked glove compartment is not possible. ◀

Rechargeable flashlight

The flashlight is located on the left side of the glove compartment.

It features integral overload protection, so it can be left in its holder continuously.

 To avoid completely discharging and possibly damaging the flashlight, always ensure that it is switched off before inserting it in the socket. ◀

Storage compartments



MV01004CMA

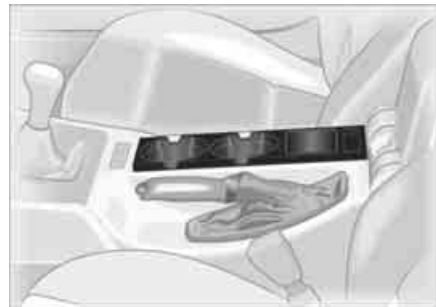

MV01005CMA

Front center armrest

To open: press the button and fold up.

Additional compartments and nets*

You will find additional storage compartments in the front doors and in the center console. Storage nets are on the front seat backrests.

Beverage holders, coin box

A coin box and two beverage holders are provided in the center console.

 Do not place any glass containers in the beverage holders, as this increases the risk of injury in the event of an accident. ◀

Storage compartments

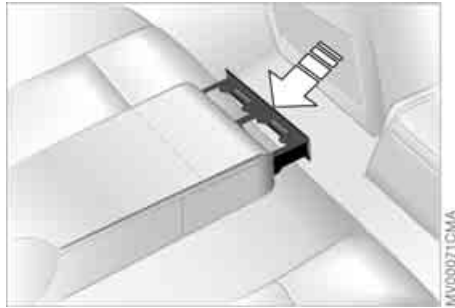

Rear center armrest*

The rear center armrest includes a beverage holder and a litter bag holder.

- ▷ Beverage holder: press.



Storage package*

For your convenience, there are:

- ▷ Two flip-out sockets on the rear center console
- ▷ An eyeglasses storage compartment*, not shown, in the center console.

Microphone*



Hands-free system

On vehicles that are wired for a telephone* or equipped with a Voice Input System*, the cover for the hands-free microphone is located in the headliner near the interior lamp.

For further information on using your cellular phone or the Voice Input System, refer to the separate Owner's Manual.

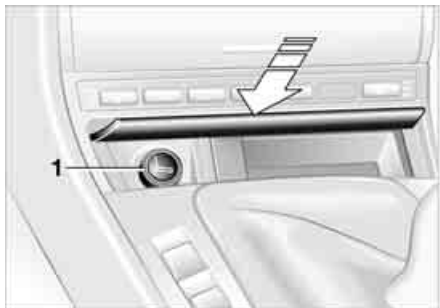
**Power socket**

The cigarette lighter socket can be used as a power socket for a flashlight, car vacuum cleaner, etc., up to a rating of approx. 200 watts at 12 volts. Do not damage the socket by inserting plugs of the wrong shape or size. In vehicles with a non-smoker's equipment package, the socket is covered by a removable cap.

To empty

Press on the edge of the open cover. the ashtray comes upward and can be removed.

Cigarette lighter

 Hold or touch the hot cigarette lighter by the knob only. Holding or touching it in other areas could result in burns.

The cigarette lighter remains operational when the ignition key has been removed. For this reason, children should never be left in the vehicle unattended. ◀

Press lighter 1 in. As soon as the lighter springs back out, it can be removed.

**To empty**

Press on the edge of the open cover in the opening direction: the ashtray comes upward and can be removed.

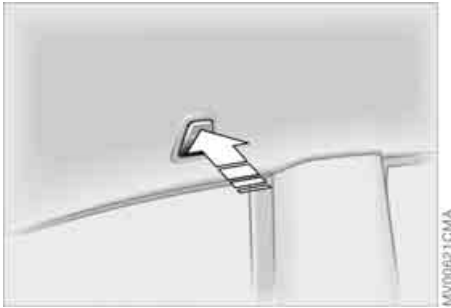

To open, press on the upper edge. For additional information: refer to page [113](#).

! When hanging clothing on the hooks, be sure that it will not obstruct the driver's vision. Do not hang heavy objects on the hooks. If you do, they could injure occupants, for example during braking or evasive maneuvers. ◀

Ski bag*

The ski bag allows the safe and clean transport of up to 4 pairs of standard skis or up to two snowboards.

The length of the ski bag and the additional space provided in the luggage compartment make it possible to carry skis up to 6 ft 10 in / 2.10 m long.

Because of the tapered shape of the bag, only two pairs of skis longer than 6 ft 10 in / 2.10 m can be carried.

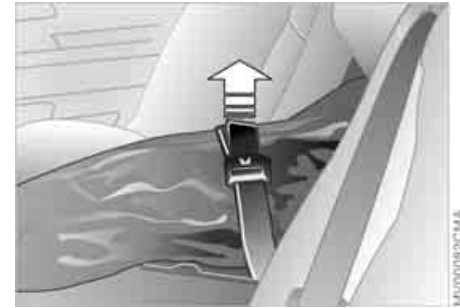
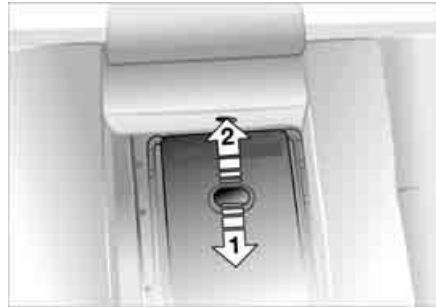

Loading

1. Fold the center armrest outward. Loosen the trim from the upper Velcro® fastener and place it on the armrest
2. Press the button downward – see arrow 1 – and swing the cover forward
3. Extend the ski bag between the front seats. The zipper provides convenient access to stored items. It may be opened to allow the ski bag to dry
4. Press the button – see arrow 2: the cover in the luggage compartment is unlocked.

To store the ski bag, perform the above steps in reverse sequence.

Securing cargo

After loading, secure the ski bag and its contents. To do so, tighten the retaining strap at the tensioning buckle.

 Be sure to secure the ski bag in this way, as it could otherwise injure occupants, for example during braking or evasive maneuvers. Be sure that the skis are clean before loading them into the bag. Be careful to avoid damage from sharp edges. ◀



Avoid overloading the vehicle so that the permitted load on the tires is not exceeded. Overloading can lead to overheating and internal tire damage. The ultimate result can assume the form of a sudden air loss. ◀

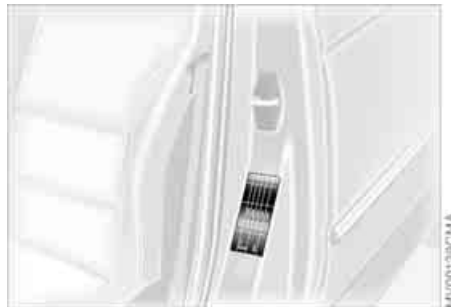

Determining the maximum load

1. Locate the following statement on your vehicle's placard*:



The combined weight of occupants and cargo should never exceed XXX kg or YYY lbs., as this could otherwise result in damage to the vehicle or unstable driving conditions. ◀

2. Determine the combined weight of the driver and passengers that will be riding in your vehicle
3. Subtract the combined weight of the driver and passengers from XXX kilograms or YYY pounds

4. The resulting figure equals the available amount of cargo and luggage load capacity.

For example, if the XXX amount equals 1,400 lbs. and there will be five 150 lbs. passengers in your vehicle, the amount of available cargo and luggage load capacity is 650 lbs.:

1,400 lbs. minus 750 lbs. = 650 lbs.

5. Determine the combined weight of luggage and cargo being loaded on the vehicle. That weight may not safely exceed the available cargo and luggage load capacity calculated in Step 4
6. If your vehicle will be towing a trailer, load from your trailer will be transferred to your vehicle. Consult the manual for transporting a trailer to determine how this may reduce the available cargo and luggage load capacity of your vehicle.

Cargo loading

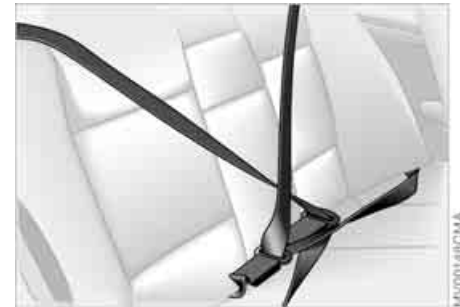
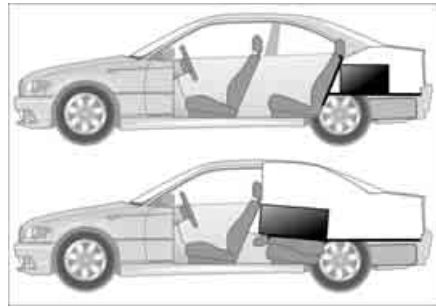
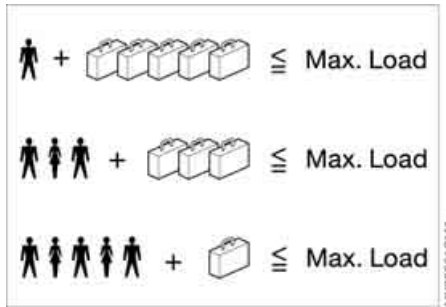

Load

The permissible load is the sum of the occupants' weights and the weight of the cargo. The greater the weight of the occupants, the less cargo can be transported.

Stowing cargo

- ▷ Load heavy cargo as far forward as possible – directly behind the backrests – and as low as possible
- ▷ Cover sharp edges and corners
- ▷ Do not pile objects higher than the top edge of the backrest

- ▷ For transporting very heavy loads when the rear seat is not occupied, secure the outer safety belts in the opposite buckles, refer to the illustration.

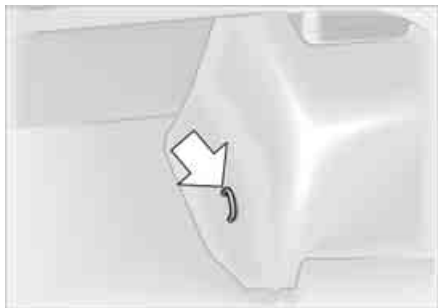

Securing cargo

- ▷ For small, light items, use the rubber-lined, non-skid side of the floor mat or secure using a luggage compartment net* or elastic straps, refer to page 35
- ▷ For large, heavy pieces, see your BMW center for load-securing devices*. Four anchorages located in the luggage compartment can be used for fastening these load-securing devices.

Comply with the information enclosed with the load-securing devices.

 Always position and secure the load correctly. If you do not, it can endanger the passengers during braking or evasive maneuvers.

Do not exceed the approved gross vehicle weight or the approved axle loads, refer to page 156, otherwise the vehicle's operating safety is no longer assured and the vehicle will not be in compliance with the certification regulations.

Do not stow heavy or hard objects in the passenger compartment without securing them. Otherwise they would be thrown around during braking and evasive maneuvers and endanger the passengers. ◀

Roof-mounted luggage rack*

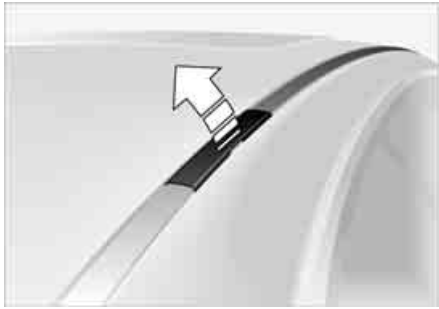

A special roof-rack system is available as an optional extra for your BMW. Please observe the precautions included with the installation instructions.

Anchorage

Access to the anchorages:

To fold up the covers, please use the tool provided with the roof-rack system.

Loading and driving notes

Roof-mounted luggage racks raise the center of gravity of the vehicle when they are loaded. For this reason, they have a major effect on the vehicle's handling and steering response.

You should therefore always remember not to exceed the approved roof load capacity, the approved gross vehicle weight or the axle loads when loading the rack. These weights are listed under Technical data on page 156.

Make sure that the load is not too bulky, and attempt to distribute it evenly. Always load the heaviest pieces first so that they are at the bottom. Be sure that adequate clearance is maintained for raising the glass sunroof, and that objects do not project into the opening path of the luggage compartment lid.

Secure the roof-mounted luggage correctly and safely to prevent it from shifting or being lost during driving.

Drive smoothly and avoid sudden acceleration and braking. Do not corner at high speeds.

The luggage rack and the roof load increase aerodynamic resistance: increased fuel consumption and additional stress on the vehicle's body are the result.



Overview

Controls and features

Operation, maintenance

Owner service procedures

Technical data

Index



To ensure that your vehicle provides maximum economy throughout a long service life, we request that you comply with the following information.

Engine and differential

The first 1,250 miles/2,000 km:

Drive at varying engine and road speeds, but do not exceed an engine speed of 4,500 rpm or a road speed of 100 mph / 160 km/h.

Always obey all official speed limits.

Do not use full throttle, and avoid pressing the accelerator beyond the kickdown point during these initial miles.

You can then proceed to increase engine or vehicle speeds once the initial 1,250 miles/2,000 km have elapsed.

Tires

Due to technical factors associated with their manufacture, tires do not achieve their full traction potential until after an initial break-in period. We thus ask you to drive with extra care during the first 200 miles/300 km.

Always obey all official speed limits.



When the vehicle is operated on wet or slushy roads, a wedge of water may form between the tire and the road surface. This phenomenon is referred to as hydroplaning and can lead to partial or complete loss of traction, vehicle control and braking effectiveness. Reduce your speed on wet roads. ◀

Brake system

Approx. 300 miles/500 km must elapse before the brake pads and rotors achieve the optimal pad-surface and wear patterns required for trouble-free operation and an extended service life later on.

To break in the separate parking brake drums, apply the parking brake lightly when coasting to a standstill – at a traffic signal, for instance – provided that traffic conditions allow you to do so.

To avoid corrosion, repeat this procedure from time to time.

Clutch

Approx. 300 miles/500 km must elapse before the clutch starts to operate at optimum efficiency. Remember to engage the clutch carefully during this initial period.

After replacing parts

Follow the same break-in procedures if any of the components mentioned above have to be replaced in the future.

General driving notes

Hot exhaust system

 High temperatures occur with every vehicle equipped with a catalytic converter. Heat shields are installed adjacent to some sections of the exhaust system. Never remove these shields; do not apply undercoating to their surfaces. When driving, standing at idle and parking the vehicle, take care to avoid contact between the hot exhaust system and flammable materials, e.g. hay, leaves, grass, etc. Such contact could lead to a fire, resulting in serious personal injury and property damage. ◀

Parking the vehicle

Condensation forms in the air conditioner system during operation, which then exits under the vehicle. Traces of condensed water on the ground underneath the vehicle are thus normal.

Before driving through a car wash

Fold in the exterior mirrors manually because they could otherwise be damaged due to the width of the vehicle.

Hydroplaning

 When driving on wet or slushy roads, reduce your speed. If you do not, a wedge of water may form between tire and road surface. This phenomenon is referred to as hydroplaning, and can lead to partial or complete loss of traction, vehicle control and braking effectiveness. ◀

The risk of hydroplaning increases as the tread depth of the tires decreases, refer also to Tire tread on page 120.

Driving through water

 Do not drive through water on the road if it is deeper than 1 ft/30 cm, and then only at walking speed. Otherwise, the vehicle's engine, the electrical systems and the transmission may be damaged. ◀

Braking safely

Your BMW is equipped with ABS as a standard feature. If you are in a situation which requires full braking, it is best to brake using maximum brake pressure: panic stop. Since the vehicle

maintains steering responsiveness, you can avoid possible obstacles with a minimum of steering effort, despite the full brake application.

Pulsation at the brake pedal, combined with sounds from the hydraulic circuits, indicates to the driver that ABS is in its active mode.

 Do not drive with your foot resting on the brake pedal. Otherwise, even light but consistent pedal pressure can lead to high temperatures, brake wear and possibly even brake failure. ◀

Wet roads:

if the roads are wet or if there is heavy rain, it is advisable to gently press the brakes for a brief moment every few miles/kilometers. Monitor traffic conditions to ensure that this maneuver does not endanger other road users. The heat generated in this process helps dry the pads and rotors. Immediate braking force is then available if necessary.

Inclines:

 To prevent overheating and, as a result, diminished braking effectiveness, drive down long or steep downhill grades in a gear which requires the least braking. Otherwise, even light but consistent pedal pressure can lead to high temperatures, brake wear and possibly even brake failure. ◀

The braking power of the engine can be further enhanced by downshifting the automatic transmission in manual mode, if necessary, into first gear. This helps avoid placing excessive loads on the brake system.

 Do not coast with the clutch depressed or with the transmission or selector lever in Neutral. Do not coast with the engine switched off. Otherwise, the engine provides no braking effect while the transmission is in idling position, and there is no power-assist for braking or steering when the engine is off.

Floor mats, floor carpets or other objects must not be in the area near the brake or accelerator pedal, as this could impair the movement of the pedals. ◀

Corrosion on the brake rotors

Limited vehicle use, extended periods with the vehicle parked or in storage, and operating conditions in which braking is restricted to gentle, low-pressure applications will all increase the tendency for corrosion to form on the rotors and contamination to accumulate on the brake pads. This occurs because the minimal pressure which must be exerted by the pads to clean the rotors by brake applications is not reached.

If the brake rotors are corroded, they will tend to respond to braking with a pulsating effect that even extended brake applications will fail to cure.

Brake pads

 For your own safety: use only brake pads that BMW has released for your particular vehicle model. BMW cannot evaluate non-approved brake pads to determine if they are suitable for use, and therefore cannot ensure the operating safety of the vehicle if they are installed. ◀

Portable phone in the vehicle

 BMW advises against using mobile equipment, e.g. cellular phones, inside the vehicle without connecting them directly to an outside antenna. Otherwise, it cannot be ruled out that vehicle electronics and the mobile equipment interfere with one another. In addition, it is not ensured that the radio waves emitted during transmission are directed outside of the vehicle interior. ◀

Antilock Brake System (ABS)

The concept

ABS keeps the wheels from locking during braking, thereby enhancing active driving safety.

Braking with ABS

If you are in a situation that requires full braking, you will exploit the full benefits of the ABS system if you apply maximum pedal pressure: panic stop. Since the vehicle maintains steering responsiveness, you can avoid possible obstacles with a minimum of steering effort, despite the full brake application.

Pulsation at the brake pedal combined with sounds from the hydraulic circuits indicates to the driver that ABS is in its active mode.

Dynamic Brake Control (DBC)

DBC is included in the DSC, refer to page 81.

The system responds to sudden, high-intensity applications of force to the brake pedal by automatically braking the vehicle with maximum boost to achieve the shortest-possible braking distances during 'panic stops'. This system exploits all the benefits of ABS.

Do not reduce the pressure exerted against the brake pedal until the braking maneuver has been completed. DBC is deactivated when you release the brake pedal.

Cornering Brake Control (CBC)

CBC is an advanced engineering development of ABS. When braking during cornering with high lateral acceleration, or when braking during a lane change, vehicle stability is improved and the steering response is enhanced.

Information for your safety

It is not merely the tire's service life, but also driving safety and driving comfort that greatly depend on the condition of the tires and the maintenance of the specified tire inflation pressure.

 Check tire inflation pressures on a regular basis and correct them, if necessary, including the compact wheel: at least twice a month and before beginning a longer trip. If this is not done, incorrect tire pressures can cause driving instability and tire damage, ultimately resulting in accidents. Do not drive with a pressureless, i.e. flat, tire, unless your vehicle is equipped with Run Flat tires. A flat tire greatly impairs steering and braking response, and can lead to complete loss of control over the vehicle. ◀

Checking tire pressures

Only check the tire inflation pressures of cold tires. This means after driving a maximum of 1.25 miles/2 km or after the vehicle has been parked for at least 2 hours. Warm tires have higher inflation pressures.

After correcting the tire inflation pressure, reinitialize the Flat Tire Monitor, refer to page 82.



Inflation pressures for original tires

Tire pressures for the standard tires of your vehicle are shown on the driver's door post, visible when the door is open.

The inflation pressures apply to BMW-approved tire sizes and recommended tire brands. Your BMW center will be glad to supply this information.

Inflation pressures for other tire sizes

The following tire pressure table shows all tire pressures for the given tire sizes at ambient temperature.

Tire inflation pressure

BMW	Tires All pressure specifications in the table are indicated in psi/kilopascal with cold tires – cold = ambient temperature				
325Ci	205/55 R 16 91 H M+S 205/55 R 16 91 H 225/50 R 16 92 W 225/45 R 17 91 W	30/210	35/240	35/240	42/290
	225/45 ZR 17 245/40 ZR 17	30/210	–	35/240	–
	245/40 ZR 17	–	35/240	–	42/290
	205/50 R 17 93 V M+S extra load	33/230	38/260	38/260	45/310
	205/50 R 17 93 W extra load				
	205/55 R 16 91 Q M+S				
	225/50 R 16 92 Q M+S				
	205/50 R 17 93 Q M+S extra load				
	225/45 R 17 91 Q M+S				
330Ci	225/45 R 17 91 W	32/220	38/260	39/270	46/320
	225/45 ZR 17	32/220	–	39/270	–
	245/40 ZR 17	–	38/260	–	46/320
	225/40 ZR 18	32/220	–	39/270	–
	255/35 ZR 18	–	38/260	–	46/320
	205/50 R 17 93 V M+S extra load	32/220	38/260	39/270	46/320
	205/50 R 17 93 W extra load				
	205/50 R 17 93 Q M+S extra load				
	225/45 R 17 91 Q M+S				
All	Space-saver spare tire		61/420		

Knowing the tire code on the tire sidewall makes it easier to correctly choose and identify your tires.

Tire size

E.g. 205/60 R 15 91 W

205 = Nominal width in mm

60 = Cross-sectional ratio in %

R = Radial belt construction

15 = Rim diameter in inches

91 = Load index, not on ZR tires

W = Speed rating, in front of the R on ZR tires

Speed rating

Q = up to 100 mph (160 km/h)

T = up to 118 mph (190 km/h)

H = up to 130 mph (210 km/h)

V = up to 150 mph (240 km/h)

W = up to 167 mph (270 km/h)

Y = up to 186 mph (300 km/h)

Tire Identification Number

Tires with DOT codes comply with the guidelines of the U.S. Department of Transportation.

DOT code:

E.g. DOT xxxx xxx 1004

xxxx = Manufacturer's code for tire brand

xxx = Tire size and tire version

1004 = Tire age

Tire age

The date on which the tire was manufactured is indicated by the code on the sidewall:

DOT ... 1004 indicates that the tire was manufactured in week 10 of the year 2004.

BMW recommends the replacement of all tires when they are no more than 6 years old, even if a tire life of 10 years is possible.

Uniform Tire Quality Grading

Quality grades can be found where applicable on the tire sidewall between tread shoulder and maximum section width. For example:

Tread wear 200 Traction AA

Temperature A

DOT quality grades

Tread wear

Traction AA A B C

Temperature A B C



All passenger car tires must conform to Federal Safety Requirements in addition to these grades. ◀

Tread wear

The tread wear grade is a comparative rating based on the wear rate of the tire when tested under controlled conditions on a specified government test course.

For example, a tire graded 150 would wear one and one-half – $1\frac{1}{2}$ – times as well on the government course as a tire graded 100. The relative performance of tires depends upon the actual conditions of their use, however, and may depart significantly from the norm due to variations in driving habits, service practices and differences in road characteristics and climate.

Traction

The traction grades, from highest to lowest, are AA, A, B, and C.

Tire code

Those grades represent the tire's ability to stop on wet pavement as measured under controlled conditions on specified government test surfaces of asphalt and concrete. A tire marked C may have poor traction performance.

 The traction grade assigned to this tire is based on straight-ahead braking traction tests, and does not include acceleration, cornering, hydroplaning, or peak traction characteristics. ◀

Temperature

The temperature grades are A, the highest, B, and C, representing the tire's resistance to the generation of heat and its ability to dissipate heat when tested under controlled conditions on a specified indoor laboratory test wheel.

Sustained high temperature can cause the material of the tire to degenerate and reduce tire life, and excessive temperature can lead to sudden tire failure. The grade C corresponds to a level of performance which all passenger car tires must meet under the Federal Motor Vehicle Safety Standard No. 109.

Grades B and A represent higher levels of performance on the laboratory test wheel than the minimum required by law.

 The temperature grade for this tire is established for a tire that is properly inflated and not overloaded. Excessive speed, underinflation, or excessive loading, either separately or in combination, can cause heat buildup and possible tire failure. ◀

RSC - Run Flat tires

Run Flat tires are labeled on the sidewall with a circular symbol containing the letters RSC, refer to page 120.

M+S

Winter and all-season tires. These have better winter driving properties than summer tires.

Tire condition

Wheel/tire damage

Inspect your tires frequently for signs of damage, foreign objects and tread wear, and check tread depth.

 Due to low-profile tires, please note that wheels, tires and suspension parts are more susceptible to road hazard and consequential damages. Unusual vibrations encountered during normal vehicle operation can indicate a flat tire or some other vehicle malfunction. This type of problem can be caused by contact with curbs, etc. This is also true for irregularities in the vehicle's handling characteristics, such as a pronounced tendency to pull to the left or right. Should this occur, respond by immediately reducing your speed. Proceed carefully to the nearest BMW center or professional tire center, or have the vehicle towed there. Tire damage, up to and including blowouts, can endanger the lives of both the vehicle occupants and other road users. ◀



TWI, Tread Wear Indicator. At a tread depth of 1/16 in/1.6 mm, the indicators signal that the legally permissible wear limit has been reached.

Tire tread

Tread depth should not be allowed to go below 1/8 in/3 mm, even though European legislation, for example, requires a minimum tread depth of only 1/16 in/1.6 mm. Below 1/8 in/3 mm tread depth, there is a great risk of hydroplaning, even at relatively moderate speeds and with only small amounts of water on the road.

At tread depths below approx.

3/16 in/4 mm, tire performance under winter driving conditions deteriorates noticeably. Worn tires should therefore be replaced for safety considerations.

Tread wear indicators in the tread-groove base, see arrow, are distributed around the wheel circumference and are labeled on the tire sidewall with

Run Flat tires*



Run Flat tires are labeled on the sidewall with a circular symbol containing the letters RSC.

Run Flat tires consist of self-supporting tires and special rims. The tire reinforcement ensures that driving remains possible to a restricted degree in the event of pressure drop or even if the tire is deflated.

Driving with a damaged tire

Depending on the cargo load, Run Flat tires allow you to continue driving at a maximum speed of 50 mph / 80 km/h.

Run Flat tires*

If there is a total loss of tire inflation pressure, 0 psi/0 kPa, or obvious tire damage, you can determine the distance you may continue driving based on the following values:

- ▷ With a light load:
 - 1 to 2 persons without luggage: approx. 155 miles/250 km
- ▷ With a medium load:
 - 2 persons, luggage compartment full; or 4 persons without luggage: approx. 90 miles/150 km
- ▷ With a full load:
 - 4 persons or more, luggage compartment full: approx. 30 miles/50 km

 Drive cautiously. Do not exceed a speed of 50 mph / 80 km/h. Be aware that vehicle handling will be altered when there is a loss in inflation pressure. Anticipate, e.g., reduced tracking during braking, longer braking distances and changed steering characteristics.

For safety reasons, BMW recommends not having damaged Run Flat tires repaired. In this case, consult your BMW center. ◀

New wheels and tires

 Have new wheels and tires mounted only by a skilled professional. Work that is improperly carried out could result in consequential damage and pose safety hazards. ◀

Ask your BMW center for details concerning the correct wheel and tire combination. Have the wheels balanced each time a wheel or tire has been replaced.

The correct wheel and tire combination also affects different systems such as ABS or DSC. The function of these systems is impaired if improper wheel and tire combinations are used.

 BMW advises against using retreaded tires, as driving safety could otherwise be impaired. This is due to the possible variations in casing structures and, in some cases, to their extreme age, which can lead to a decrease in their durability. ◀

The correct wheels and tires

 BMW recommends using only wheels and tires that have been tested and approved by BMW for the particular vehicle model, as otherwise body contact and serious accidents can result despite the use of the same nominal size, e.g. due to manufacturing tolerances. BMW cannot evaluate all tires and wheels on the market, and is thus unable to guarantee that the vehicle will continue to perform safely if unapproved tires and/or wheels are mounted. ◀

To maintain good handling and vehicle response, use only tires of a single brand and tread configuration. After a flat tire, have the previous wheel and tire combination restored as soon as possible.

Recommended tire sizes and brands

For each tire size, certain tire brands have been tested, classified as road-safe and approved by BMW. You can find out about these from a professional

tire center, preferably your BMW center. Observe any country-specific regulations, e.g. on making a corresponding entry in the vehicle documents.

The factory-approved radial belt tires are matched to your vehicle and provide optimum safety and driving comfort when used properly.

Run Flat tires

If your vehicle is equipped with Run Flat tires, refer to Run Flat tires, use only these tires since no spare wheel is available in the event of a flat.

Special characteristics of winter tires

BMW recommends the use of winter tires for operation under winter road conditions. While all-season tires with M+S designation provide better winter traction than summer tires, they generally do not achieve the full performance of winter tires.

Run Flat tires:

If your vehicle is equipped with Run Flat tires, refer to Run Flat tires, please note the following: when mounting new tires or replacing summer tires with winter

tires, or vice versa, use only Run Flat tires since no spare wheel is available in the event of a flat. Your BMW center will be glad to advise you.

Observing speed ratings:



Never exceed the maximum speed for which the winter tires are rated. Unprofessional attempts by laymen to service tires can lead to damage and accidents. Have this work performed by skilled professionals only. The technicians at your BMW center will be glad to assist you with the required professional knowledge and specialized equipment. ◀

Storage

Always store tires in a cool, dry place. Store them away from light whenever possible. Protect the tires against contact with oil, grease and fuel. Do not exceed the maximum tire inflation pressures specified on the tire sidewall.

Snow chains*

Only certain snow chains have been tested by BMW and determined and approved as roadworthy. Consult your BMW center for details. BMW recommends using only these approved fine-link snow chains. Use them in pairs on either summer or winter tires, but only on both rear wheels.

Comply with all manufacturer's safety precautions when mounting the chains. Do not exceed a speed of 30 mph / 50 km/h when using snow chains.

You cannot mount snow chains on the following tires:

- ▷ 225/50 R 16
- ▷ 225/45 R 17
- ▷ 245/40 R 17
- ▷ 225/40 R 18
- ▷ 255/35 R 18.



Do not initialize the Flat Tire Monitor after mounting snow chains to the tires.

When driving with snow chains, it may be useful to turn off the DSC for a short time, refer to page 81 or 82. ◀



To release

Pull the lever located under the left-hand side of the instrument panel.

⚠ Do not attempt to service your vehicle if you do not have the required technical background. If you are not familiar with the regulations to be observed, have your vehicle serviced only by a BMW center or a shop that works according to BMW requirements with the appropriately trained personnel. Work that is improperly carried out could result in consequential damage and pose safety hazards. ◀

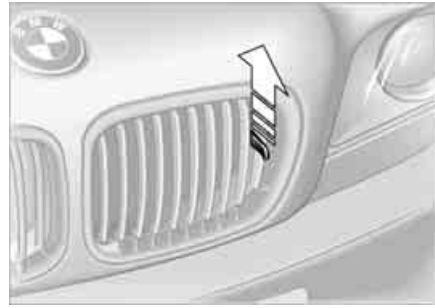

To open

Pull the release handle and open the hood.

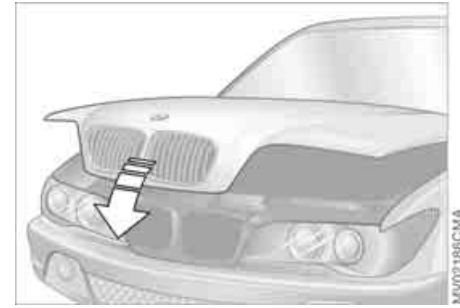

To close

Allow the hood to fall from a height of about 1 ft/30 cm so that it audibly engages.

⚠ To avoid injuries, be sure that the travel path of the hood is clear when it is closed, following the same safety precautions used in all closing procedures. If you notice while driving that the hood is not completely closed, stop immediately and close it securely. ◀

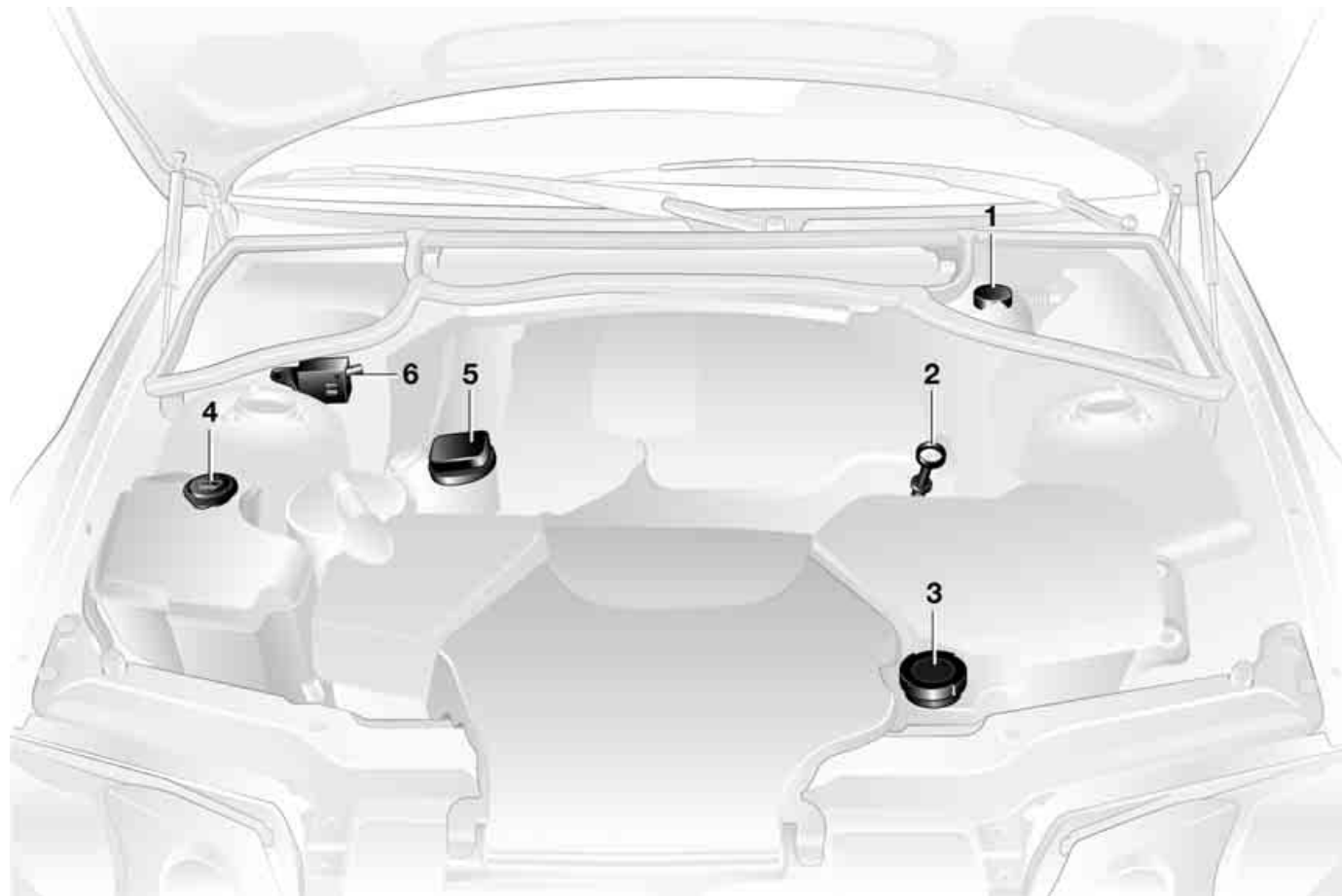

- 1 Brake fluid reservoir [128](#)
- 2 Engine oil dipstick [126](#)
- 3 Coolant expansion tank [128](#)
- 4 Reservoir for the headlamp and windshield washer system [126](#)
- 5 Engine oil filler neck [127](#)
- 6 Auxiliary terminal for jump-starting [147](#)

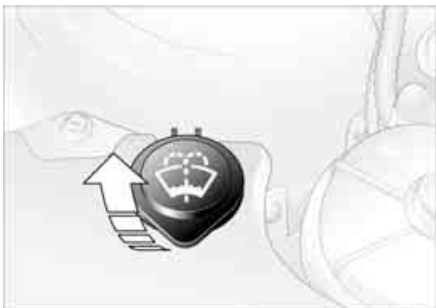

Headlamp* and windshield washer system

Capacity approx.
5.6 US quarts/5.3 liters

Fill with water and, if required, with a washer antifreeze additive according to manufacturer's recommendations.



We recommend that you mix the washer fluid before adding it to the reservoir. ◀



Antifreeze agents for the washer fluid are highly flammable. For this reason, keep them away from sources of flame and store them only in closed original containers, inaccessible to children. Comply with the instructions on the containers. ◀

Engine oil

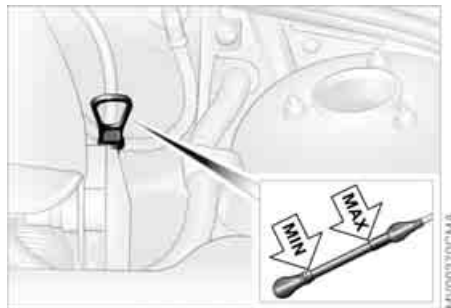

The oil volume between the two marks on the dipstick corresponds to approx. 1.1 US quarts/1 liter. Do not fill beyond the upper mark on the dipstick. Excess oil will damage the engine.

Checking the oil level

1. Park the vehicle on a level surface
2. Switch the engine off after it has reached normal operating temperature
3. After approx. 5 minutes, pull the dipstick out and wipe it off with a clean lint-free cloth, paper towel, or similar material
4. Carefully push the dipstick all the way into the guide tube and pull it out again
5. The oil level should be between the two marks on the dipstick.

As with fuel economy, oil consumption is directly influenced by your driving style and vehicle operating conditions.

Engine oil

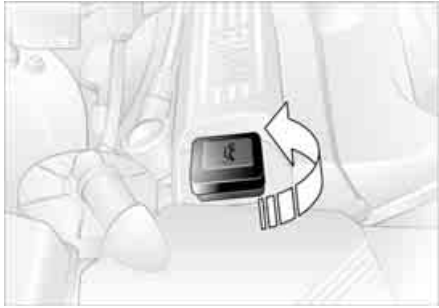

Adding engine oil

Only add engine oil when the oil level has dropped to just above the lower mark on the dipstick.

 Continuous exposure to used oil has caused cancer in laboratory testing. For this reason, any skin areas that come into contact with oil should be thoroughly washed with soap and water.

Store oils, grease and similar materials so that they are inaccessible to children. Comply with warning labels and information on containers. ◀

 Comply with the applicable environmental laws regulating the disposal of used oil. ◀

Recommendation: have the oil changed at your BMW center.

Specified engine oils

The quality of the engine oil is extremely important for the operation and service life of an engine. Based on extensive testing, BMW has approved only certain grades of engine oil.

Use only approved BMW High Performance Synthetic Oil.

If an approved BMW High Performance Synthetic Oil should be unavailable, you may use small amounts of other synthetic oils for topping up between oil changes. Use only oils with the specification API SH or higher.

 Ask your BMW center for details concerning the specific BMW High Performance Synthetic Oil or synthetic oils that have been approved. ◀

 BMW engines are designed to operate without oil additives; the use of additives could even lead to damage in some cases. ◀

You can also call BMW of North America toll-free at 1-800-831-1117 or visit this website: www.bmwusa.com to obtain this information.

Viscosity ratings

Viscosity is the oilflow rating as established in SAE classes.

The selection of the correct SAE class depends on the climatic conditions in the area where you drive your BMW.

 Approved oils are in SAE classes 5W-40 and 5W-30. ◀

These kinds of oil may be used for driving in all ambient temperatures.

 Do not add coolant to the cooling system when the engine is hot. If you attempt to do so, escaping coolant can cause burns. ◀

Coolant consists of water as well as an additive such as antifreeze with corrosion inhibitor. Not all commercially available additives are suitable for your BMW. Your BMW center knows which additives are appropriate.

 Only use approved additives, as the engine could otherwise be damaged. The additives are hazardous to your health; therefore, follow the instructions on the containers. ◀

 Comply with the applicable environmental laws regulating the disposal of antifreeze with corrosion inhibitor. ◀



Checking the coolant level and adding coolant

Check the coolant level when the engine is cold, approx. 68 °F/+20 °C.

1. Open the cap for the expansion tank by turning it slightly counterclockwise to allow accumulated pressure to escape. Then open
2. The coolant level is correct when the upper end of the red float rod is at least even with the upper edge of the filler neck; see arrow. The end of the float may stick out by a maximum of 3/4 in/2 cm – that is, up to the second mark on the float
3. If necessary, add coolant. If the coolant is low, slowly add coolant until the correct level is reached – do not overfill.

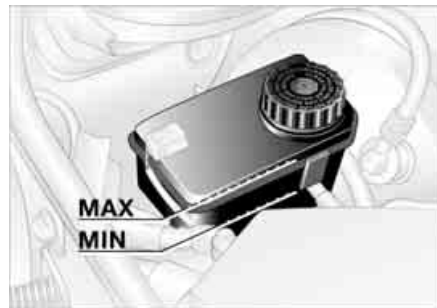

Indicator lamp

 The warning lamp comes on even though the parking brake is released:

The brake fluid level in the reservoir is too low, refer to page 18. At the same time, there may be significantly greater pedal travel. Have the system checked as soon as possible.

 Warning lamp for Canadian models.

 If you continue driving, extended pedal travel may be necessary and braking distances may be significantly longer. Be sure to adapt your driving style accordingly. ◀

Brake fluid

Adding brake fluid

For adding brake fluid or for determining and correcting the cause of brake fluid loss, consult your BMW center. Your BMW center is familiar with the specifications for factory-approved brake fluids – DOT 4.

Brake fluid loss may result in extended brake pedal travel.



Brake fluid is hygroscopic, that is, it absorbs moisture from the air over time.

In order to ensure the brake system's safety and reliability, have the brake fluid changed every two years by a BMW center. Refer to the Service and Warranty Information Booklet for US models or the Warranty and Service Guide Booklet for Canadian models. Brake fluid is toxic and damages the vehicle's paint. You should always store it in its closed original container and in a location which is out of reach of children.

Do not spill the brake fluid and do not fill the brake fluid reservoir beyond the MAX mark. The brake fluid could ignite upon contact with hot engine parts and cause serious burns. ◀



Comply with the applicable environmental laws regulating the disposal of brake fluid. ◀

The BMW Maintenance System helps maintain your vehicle's road safety and operational safety. Comfort-related aspects, such as the timely change of filters for the air inside the vehicle, are taken into consideration. The goal is to optimize maintenance with respect to low total cost of ownership.

If you should sell your BMW one day, consistent service and maintenance will prove to your advantage.



Service interval display

The service interval display shows you when an oil service, an inspection – always alternating between I and II – or a brake fluid change is due. The special feature is that the service intervals are calculated according to your BMW's individual driving conditions instead of from fixed mileage increments.

The technology developed for this takes your personal driving style into account, as well as your BMW's driving conditions. After all, short-distance driving, i.e. frequent cold starts, or driving off at high engine speeds, affects your BMW differently from long-distance driving with the engine at consistent operating temperature.

Special feature regarding engine oil change

The calculation of the service intervals covers practically every kind of operating situation. If you drive very rarely, however, you should have the oil changed at least every two years, since engine oil deteriorates over time regardless of use.

Service and Warranty Information Booklet for US models/ Warranty and Service Guide Booklet for Canadian models

For additional information on required maintenance intervals and procedures, please refer to the Service and Warranty Information Booklet for US models, or the Warranty and Service Guide Booklet for Canadian models.

As a precaution against rust, it is advisable to have the body checked for damage from rocks or gravel at the same time, depending upon operating conditions.



Have your BMW center perform maintenance and repair.

Be sure that all maintenance work is recorded in the Service and Warranty Information Booklet for US models, or in the Warranty and Service Guide Booklet for Canadian models. These entries are your verification of regular maintenance on your vehicle and are required for the performance of warranty repairs. ◀

Care

You can find everything you need to know on this topic by consulting the separate Caring for your vehicle brochure.

Proposition 65 warning

California laws require us to state the following warning:

 Engine exhaust and a wide variety of automobile components and parts, including components found in the interior furnishings in a vehicle, contain or emit chemicals known to the State of California to cause cancer and birth defects and reproductive harm. In addition, certain fluids contained in vehicles and certain products of component wear contain or emit chemicals known to the State of California to cause cancer and birth defects or other reproductive harm.

Battery posts, terminals and related accessories contain lead and lead compounds. Wash your hands after handling.

Used engine oil contains chemicals that have caused cancer in laboratory animals. Always protect your skin by washing thoroughly with soap and water. ◀

Event data recorders

Your vehicle may be equipped with one or more sensing and diagnostic modules or a recording device capable of recording or transmitting certain vehicle

data or information. In addition, if you have a Subscription Service Agreement for the BMW Assist system, certain vehicle information may be transmitted or recorded in order to provide such services.

OBD interface socket

The interface socket for onboard diagnostics is located on the left-hand side of the driver's side, below the instrument panel and under a cover panel. The cover has the letters OBD on it.

This interface makes it possible to access data on emissions-related components using special equipment.

 An illuminated indicator informs you of the need for service, not that you need to stop the vehicle. However, the systems should be checked by your BMW center at the earliest possible opportunity.

If the indicator blinks or flashes, this indicates a high level of engine misfire. Reduce speed and contact the nearest BMW center immediately. Severe

OBD interface socket

engine misfiring for even a short period of time can seriously damage emission control system components, especially the catalytic converter.



Service Engine Soon warning lamp for Canadian models.



If the gas cap is not on tight enough, the OBD system can detect leaking vapor and the indicator will light up. If the gas cap is then tightened, the indicator will usually go out after a short period of time. ◀

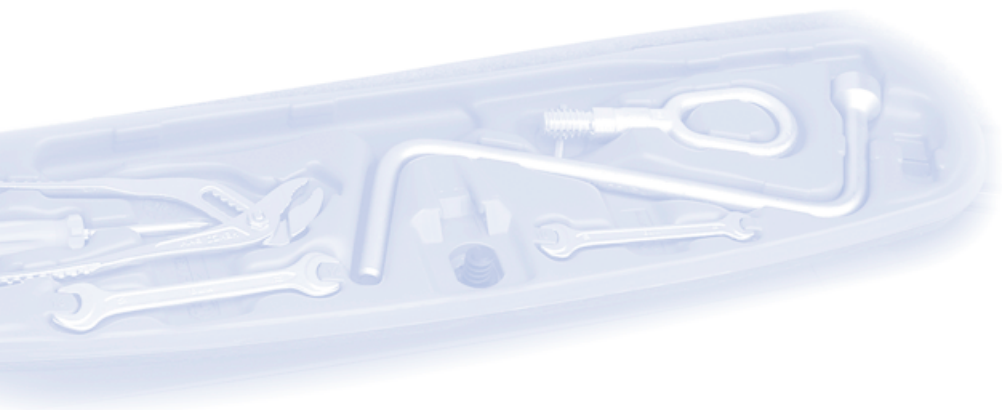



Overview

Controls and features

Operation, maintenance

Owner service procedures

Technical data

Index

Overview

Controls

Maintenance

Repairs

Data

Index

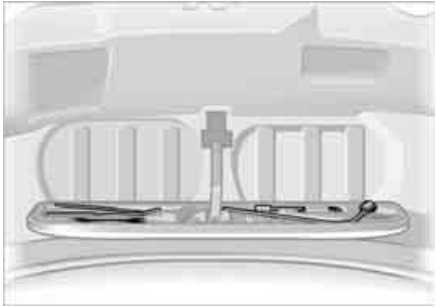

The onboard tool kit is located in the luggage compartment lid.

Loosen the wingnut to open.

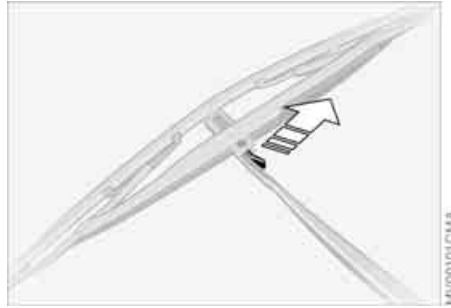

1. Switch off the engine
2. Fold the wiper arm completely out from the windshield
3. Position the wiper blade at an angle and pull the release spring – see arrow
4. Fold the wiper blade down and unhook it toward the windshield
5. Pull the wiper blade past the wiper arm toward the top
6. Insert a new wiper blade and apply pressure until you hear it engage.

Lamps and bulbs

The lamps and bulbs make essential contributions to the safety of your vehicle. Therefore, proceed carefully when handling bulbs. BMW recommends that you have such work performed by your BMW center if you are not familiar with the procedures.

 Do not touch the glass portion of a new bulb with your bare hands since even small amounts of impurities burn in to the surface and reduce the service life of the bulb. Use a clean cloth, paper napkin, or a similar material, or hold the bulb by its metallic base. ◀

A replacement bulb set is available from your BMW center.

 Before working on the electrical system, switch off the electrical accessory you are working on or disconnect the cable from the negative terminal of the battery. Failure to observe this precaution could result in short circuits. To prevent injuries and damage, comply with any instructions provided by the bulb manufacturer. ◀

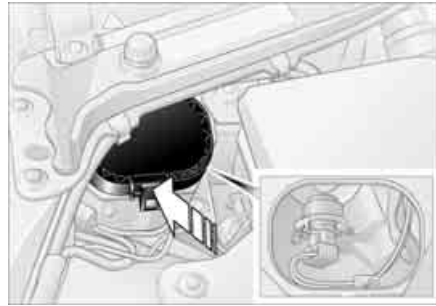

Low beams

H7 bulb, 55 watt

Engine compartment, left side:

 The H7 bulb is pressurized. Therefore, wear safety glasses and protective gloves. Failure to comply with this precaution could lead to injury if the bulb is damaged. ◀

1. Remove the cover of the headlamp by pressing the tab and lifting the cover off
2. Pull off the plug
3. Release the retaining wire
4. Remove and replace the bulb.

 When cleaning the headlamps, please follow the instructions in the Caring for your vehicle brochure. ◀

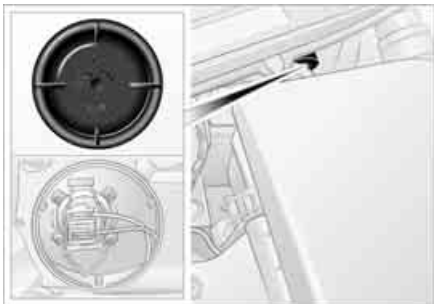

High beams

H7 bulb, 55 watt

Engine compartment, left side:

 The H7 bulb is pressurized. Therefore, wear safety glasses and protective gloves. Failure to comply with this precaution could lead to injury if the bulb is damaged. ◀

1. Turn the cover to the left and remove
2. Pull off the plug
3. Release the retaining wire
4. Remove and replace the bulb.

 Note the letters TOP when putting the cover in place. ◀

 When cleaning the headlamps, please follow the instructions in the Caring for your vehicle brochure. ◀

Xenon lamps*

The service life of these bulbs is very long and the probability of a failure is very low, provided that they are not switched on and off an unusual number of times. If one of these bulbs should nevertheless fail, it is possible to continue driving with great caution using the fog lamps, provided local traffic laws do not prohibit this.

 Because of the extremely high voltages involved, any work on the xenon lighting system, including bulb-changing, should be carried out by technically-qualified personnel only. Otherwise, there is a risk of fatal injury. ◀

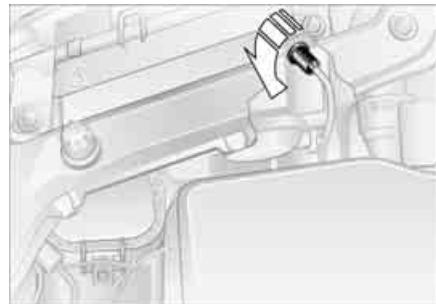

Parking lamps

5 watt bulb

Engine compartment, left side:

1. Turn the bulb holder to the left and remove
2. Pull the bulb off and replace it.

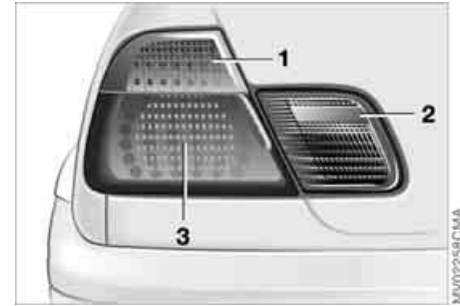
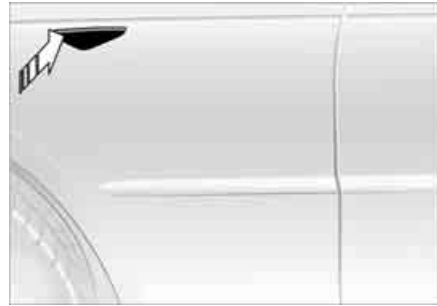
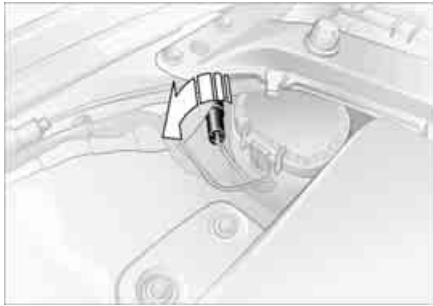

Front turn signal indicators

21 watt bulb

1. Turn the bulb holder with the plug to the left and remove
2. Pull the bulb off and replace it.

 When replacing the bulb on the right, loosen and lift the reservoir for the headlamp and windshield washer system if necessary. ◀

Side turn signal indicators

1. Press the front edge of the lamp toward the back with the tip of your finger and remove
2. Pull off the plug and replace the entire lamp.

 The side turn signal indicator is designed using LED technology. If faulty, the entire side turn signal indicator must be replaced. ◀

Rear lamps

- 1 Turn signal indicator LEDs
- 2 Backup lamp
21 watt bulb
- 3 Tail lamp/brake lamp LEDs

 Please contact a BMW center in case of a defect with the LED lamps. ◀

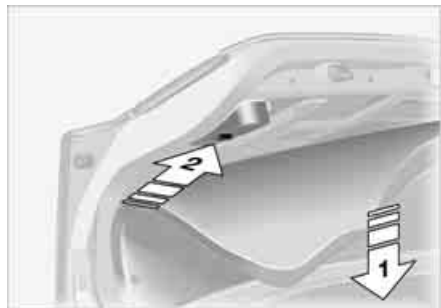

Bulbs in the luggage compartment lid:
1. Using a screwdriver, loosen the clip

2. Swing trim panel down – see arrow 1. Release the bulb holder – see arrow 2 – and remove it
3. Applying light pressure, turn the bulb to the left. Remove and replace the bulb
4. Press the bulb holder into place, continuing until you hear it engage
5. Reinstall the trim panel with the clip.

Center high-mount brake lamp

LED strip on the rear window.

Please contact your BMW center in case of a malfunction.

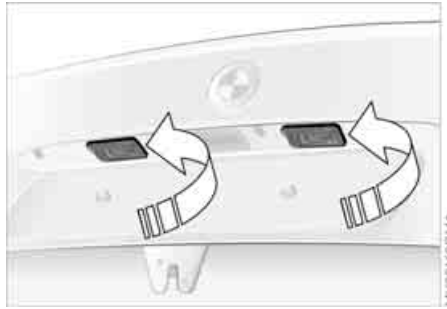

License plate lamps

5 watt bulb

1. Place a screwdriver in the slot and press toward the left to release the lens
2. Replace the bulb.

Light-emitting diodes

Light-emitting diodes (LEDs) installed behind translucent lenses serve as the light sources for many of the controls and displays in your vehicle. These light-emitting diodes are related to conventional lasers, and legislation defines them as light-emitting diodes, Class 1.

 Do not remove the protective lens, and avoid staring directly at the unfiltered beam for several hours, as inflammation of the retina could result. ◀

 Safety precautions in the event of a flat tire or wheel change:

Stop the vehicle as far as possible from passing traffic. Park on a firm, flat surface. Switch on the hazard warning flashers. Turn the steering wheel to the straight-ahead position and engage the steering lock. Shift into 1st or Reverse, or if you have an automatic transmission position the selector lever in Park, and engage the parking brake.

All passengers should be outside the vehicle and well away from your immediate working area, behind a guardrail, for example.

If a warning triangle or portable hazard warning lamp is available, set it up on the roadside at an appropriate distance from the rear of the vehicle. Comply with all local safety guidelines and regulations.

Change the wheel only on a level, firm surface which is not slippery. Avoid jacking the vehicle on a soft or slippery support surface – snow, ice, loose gravel, etc. – as either the vehicle or the jack could slip sideways.

Position the jack on a firm support surface.

Do not place wooden blocks or similar objects under the jack. They could prevent the jack from extending to its full

142 Changing a wheel

height and reduce its support capacity. Do not lie under the vehicle or start the engine when the vehicle is supported by the jack. There is otherwise a risk of fatal injury. ◀

Your BMW is equipped with a spare tire or a space-saver spare tire designed for temporary use in maintaining the vehicle's mobility in an emergency.

▶ To remove the spare tire, lift the floor panel in the luggage compartment completely out, refer to page 35. ◀

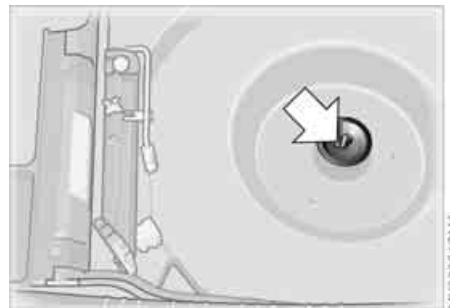
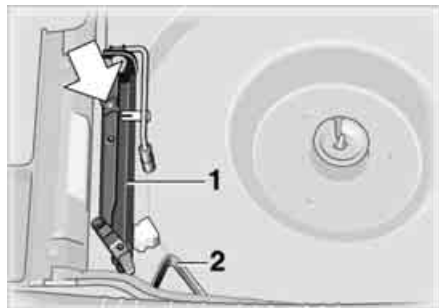

What you will need

In order to avoid rattling noises later, note the position of the tools when you remove them and return them to their original position when you are done using them.

▷ Jack 1

Lift the floor panel within the luggage compartment, refer to page 35, and undo the red wingnut.

When you have completed work, screw the jack all the way back down. Fold the handle back and insert it in its holder

▷ Chock 2

Located behind the jack on the wall in the luggage compartment. Loosen the wing nut to remove it

- ▷ Spare tire or space-saver spare tire – located next to the jack
Loosen the wing nut by hand, remove the storage shelf and take the wheel out
- ▷ Lug wrench – in the onboard tool kit on the underside of the luggage compartment lid, refer to page 136.

Procedure

1. Read and comply with the safety precautions provided on the previous page
2. Secure the vehicle from rolling:
Place the wedge against the rear surface of the front tire on the side opposite the side being raised. If the vehicle is parked on a downward slope, place the wedge securely in front of the tire. If the

Changing a wheel

wheel must be changed on a surface with a more severe slope, take additional precautions to secure the vehicle from rolling

3. Wheels with full wheel covers*: reach into the ventilation openings and pull the cover off
4. If your vehicle is equipped with Individual light-alloy wheels*: insert the wheel puller supplied with the vehicle into the designated recess of the cover, and pull the cover off
5. Loosen the lug bolts by rotating half a turn

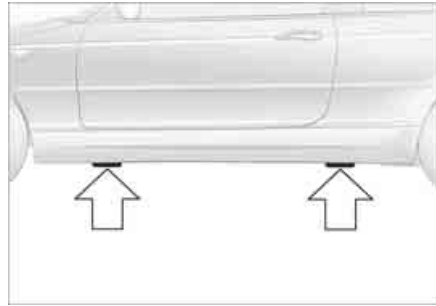

6. Position the jack at the jacking point closest to the flat tire with the jack base vertically below the jacking point and the entire surface of the head of the jack moves into the square recess of the jacking point – refer to the detail in the next illustration – when the jack is cranked
7. Jack the vehicle up until the wheel you are changing is raised from the ground
8. Unscrew the lug bolts and remove the wheel
9. Remove accumulations of mud or dirt from the mounting surfaces of the wheel and hub. Clean the lug bolts
10. Position the new wheel or the space-saver spare tire on the hub and screw at least two lug bolts finger-tight into opposite bolt holes
11. Screw in the remaining lug bolts. Screw in all the bolts in diagonal pattern
12. Lower the jack and remove it from beneath the vehicle
13. Tighten the lug bolts securely in a diagonal pattern

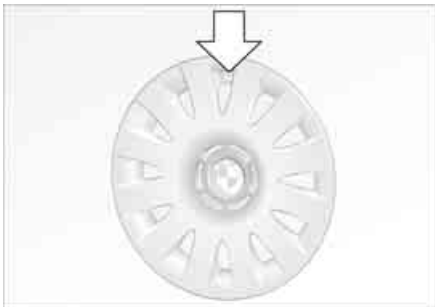

 Do not attempt to install the full wheel cover on the space-saver spare tire, since this could damage the cover. ◀

 The vehicle jack is designed for changing wheels only. Do not attempt to raise another vehicle model with it or to raise any load of any kind. To do so could cause accidents and personal injury. To ensure continued safety, have the tightness of the torque bolts checked with a calibrated lug wrench – torque specification: 88.5 lb ft/120 Nm – at the earliest opportunity. ◀

When storing a wheel in the spare tire recess, take care to avoid bending the threaded rod. If the original BMW light-alloy wheels have been replaced with other light-alloy wheels, different lug bolts may be required.

Replace the defective tire as soon as possible and have the new wheel/tire balanced.

Driving with the space-saver spare tire

Drive cautiously. Do not exceed a speed of 50 mph / 80 km/h.

Be aware that vehicle handling may be altered. Anticipate, e.g., reduced tracking during braking, longer braking distances and changed steering characteristics when approaching limit conditions. These handling characteristics will be even more pronounced if winter tires are mounted.

 Only one space-saver spare tire may be mounted at one time. Mount a wheel and tire of the original size at the earliest possible opportunity. ◀

Driving with a spare tire*

 For certain wheel/tire combinations, the size of the spare tire will differ from that of the remaining tires. The spare tire is fully functional at all loads and speeds. However, the spare tire should be replaced at the earliest possible opportunity in order to achieve the original operating conditions. ◀

14. Wheels with full wheel covers*: place the wheel cover with the valve opening over the valve. Use both hands to press the cover securely onto the rim
15. Check and correct the tire inflation pressure at the earliest opportunity. Vehicles with Flat Tire Monitor: after mounting the spare tire or correcting the tire inflation pressure, reinitialize the system, refer to page 82.

Protect valve stems and valves from dirt using screw-on valve stem caps. Dirty valve stems frequently lead to slow pressure loss.

Battery

Maintenance

The battery is completely maintenance-free. This means that the original battery acid will normally last for the service life of the battery under moderate climate conditions. Your BMW center will be glad to advise you if you have any questions concerning the battery.

Charging the battery

When charging the battery in the vehicle, leave the engine off at all times. Connect the charge cables to the terminals in the engine compartment. For terminal locations, refer to Jump-starting on page 147.

Disposal



After changing the battery, have the old battery disposed of by your BMW center or bring it to a recycling point. Maintain the battery in an upright position for transport and storage. Secure the battery against falling over in transit. ◀

Power loss

After a temporary power loss, e.g. due to a discharged battery, some equipment will be limited in its use and will have to be reinitialized. Individual settings are also lost and must be reset:

- ▷ Seat and mirror memory
The position settings must be stored again, refer to page 47
- ▷ Clock
must be reset, refer to page 77
- ▷ Radio
Stations must be reset, refer to the Owner's Manual for Radio/Onboard Computer
- ▷ Navigation system
The system will not be operable immediately, refer to the Owner's Manual for Radio/Onboard Computer.

Fuses

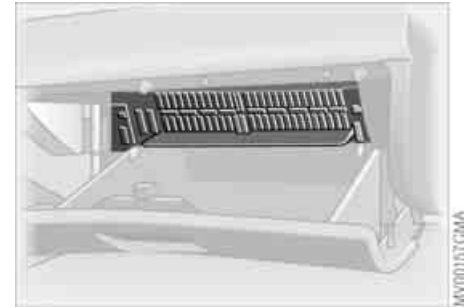

You will find the fuses and information on their respective allocation in the glove compartment behind a panel with two snap clips.

 Do not attempt to repair a blown fuse or replace it with a fuse having a different color or amperage rating. To do this could cause a fire in the vehicle resulting from a circuit overload. ◀

The BMW Group's Mobile Service offers you 24-hour assistance in the event of a breakdown, even on weekends and holidays.

The telephone numbers of the Mobile Service control center in your country are listed in the BMW Dealer Directory.

If your vehicle has the necessary equipment, you can contact the Mobile Service or issue an emergency call using buttons in the interior rearview mirror.

When an emergency call is initiated, a telephone connection is established with the BMW Assist response center.

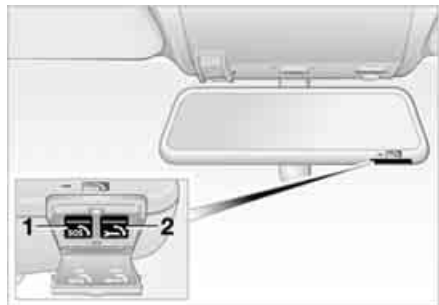

Fold down the cover.

1 Emergency call

2 Mobile Service

Requirements for initiating an emergency call or contacting Mobile Service:

- ▷ Ignition key in position 1 or higher
- ▷ The car phone must be registered with a mobile network
- ▷ The emergency call system must be operational.

Initiating an emergency call*

Press button 1 for at least 2 seconds.

The indicator lamp above the buttons lights up. As soon as a telephone connection has been set up to the BMW Assist response center, the indicator lamp flashes.

If the situation permits you to do so, wait in the vehicle until the voice connection is established. You can then provide detailed information to the response center.

If your vehicle is equipped with an activated BMW Assist and the current location of the vehicle can be determined, this location is transmitted to the BMW Assist response center.



If the navigation system has failed, the current location of the vehicle is not transmitted. ◀

If the indicator lamp is flashing but you cannot hear the BMW Assist response center over the hands-free system, it is possible that e.g. the hands-free system is malfunctioning. The BMW Assist response center can still hear you, however.

If certain requirements are met, an emergency call is automatically initiated after a serious accident. The automatic emergency call will not be hindered by pressing the button.



For technical reasons, the emergency call function cannot be guaranteed in certain unfavorable conditions. ◀

Receiving assistance

Mobile Service*

To establish contact with the BMW Group's Mobile Service:

Press button 2 for at least 2 seconds.

The indicator lamp above the buttons lights up. As soon as a telephone connection has been set up with the Mobile Service, the indicator lamp flashes.

Depending on the country you are in, your vehicle's current location will also be transmitted if your vehicle is equipped with an activated BMW Assist function.

Jump-starting

When your battery is discharged, you can use two jumper cables to start your vehicle with power from the battery in a second vehicle. You can also use the same method to help start another vehicle. Only use jumper cables with fully insulated handles on the terminal clamps.

 Do not touch high-voltage wiring and cables on a running engine. Contact with components carrying high voltage can be harmful or fatal. Carefully observe the following instructions to avoid personal injury and/or damage to one or both vehicles. ◀

Preparations

1. Check whether the battery of the support vehicle has 12 volts and approximately the same capacity – measured in Ah. This information is provided on the battery
2. Stop the engine of the support vehicle
3. Switch off all electrical components in both vehicles.

 Make absolutely certain that there is no contact between the bodywork of the two vehicles, otherwise there is a short circuit hazard. ◀

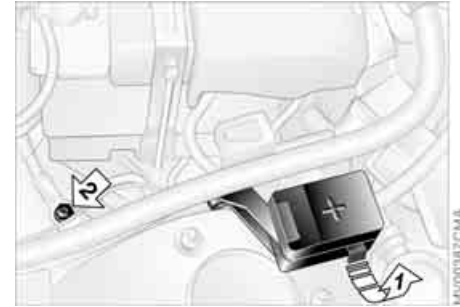

Connecting the jumper cables

 Always adhere to this sequence when connecting jumper cables; failure to observe this procedure can lead to sparks at the battery terminals and pose an injury hazard. ◀

The auxiliary jump-starting terminal located in your BMW's engine compartment acts as the positive battery terminal. Refer to the engine compartment overview on page 124. The cover of this auxiliary terminal is marked with a +.

1. Open the cover of the BMW auxiliary jump-starting terminal. Do so by pulling the tab – see arrow 1

2. Connect one terminal clamp of the plus/+ jumper cable to the positive terminal of the battery or to an auxiliary jump-starting terminal of the support vehicle
3. Connect the second terminal clamp of the plus/+ jumper cable to the positive terminal of the battery or to an auxiliary jump-starting terminal of the vehicle to be started
4. Your BMW is equipped with a special nut – see arrow 2 – to serve as the ground or negative terminal. Attach a terminal clamp of the minus/- jumper cable to the negative terminal of the support vehicle's battery or to a suitable ground on its engine or bodywork
5. Attach the second terminal clamp of the minus/- jumper cable to the negative terminal of the battery or to a suitable ground on the engine or bodywork of the vehicle to be started.

Starting the engine

1. Start the engine of the support vehicle and let it run for several minutes at a slightly elevated engine idle speed

2. Start the engine of the other vehicle as usual.
If the first start attempt is not successful, wait a few minutes before another attempt in order to allow the discharged battery to recharge
3. Allow the engines to run for several minutes
4. Disconnect the jumper cables in reverse sequence.

Depending on the cause of the fault, have the battery checked and recharged by your BMW center.



Do not use spray starter fluids to start the engine. ◀

Towing and tow-starting the vehicle

 Always observe all applicable towing laws and regulations. ◀

Using the towing eyelet

The screw-in towing eyelet is located in the luggage compartment under the floor panel; be sure that it remains with the vehicle at all times. It can be attached at the front or rear of your BMW.

 Observe the following instructions in order to avoid damaging the towing eyelet or the vehicle: use only the towing eyelet supplied with the vehicle, and screw it in firmly until it stops. Use the towing eyelet for towing on paved roads only. Avoid subjecting the towing eyelet to lateral loads, e.g. do not lift the vehicle using the towing eyelet. ◀



Access to the threaded socket

Press out the cover in the front or rear bumper with a screwdriver at the top of the recess.

Being towed

 Make sure that the ignition key is in position 1, because the steering lock could otherwise engage and the vehicle could no longer be steered. There is no power assist while the engine is off. Therefore, you will need to exert more force to brake and steer the vehicle. ◀

Turn on the hazard warning flashers, if required by national regulations. If the electrical system has failed, clearly identify the vehicle being towed, e.g. by placing a sign or a warning triangle in the rear window.

Vehicles with manual transmission: gearshift lever in idling position.

Vehicles with automatic transmission: selector lever in position N.

 Do not exceed a towing speed of 45 mph / 70 km/h, nor a towing distance of 90 miles/150 km, because the automatic transmission could otherwise be damaged. ◀

Vehicles with sequential manual gear-box SMG: selector lever in position N.

Towing methods

In some countries, it is not permitted to tow the vehicle with a tow bar or tow rope on public roads.

Familiarize yourself with the applicable towing regulations for the country in which you are driving.

With a tow bar

 The towing vehicle must not be lighter than the vehicle being towed; otherwise, vehicle handling can no longer be controlled. ◀

The towing eyelets of both vehicles should be on the same side.

If the tow bar can only be used in a diagonal position, please note the following:

- ▷ Clearance is restricted while you are driving around corners
- ▷ The inclination of the tow bar produces lateral force.

 Only attach the tow bar to the towing eyelets. Other parts of the vehicles could otherwise be damaged. ◀

With a tow rope

When the towing vehicle is driving off, make sure that the tow rope is taut.

 Use nylon ropes or straps for towing because they prevent sudden jerking movements. Attach the tow rope only to the towing eyelets. Other parts of the vehicles could otherwise be damaged. ◀

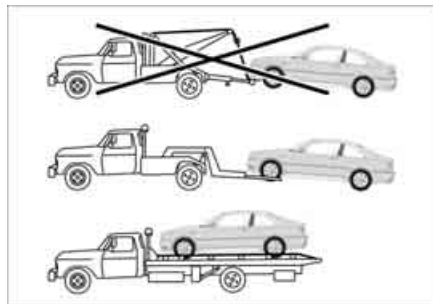

With a tow truck

Have the BMW transported by a tow truck with a lift sling, or on a flatbed.

 Never allow passengers to ride in a towed vehicle for any reason. ◀

 Do not lift the vehicle by the towing eyelet, nor by parts of the body or chassis. Otherwise damage could result. ◀

Tow-starting

 Do not tow-start vehicles with automatic transmissions. Jump-starting, refer to page 147. ◀

Only tow-start vehicles with catalytic converters if the engine is cold. It is better to have the engine jump-started, refer to page 147.

1. Turn on hazard warning flashers; comply with national regulations
2. Turn the ignition key to position 2
3. Engage the 3rd gear
4. Have the vehicle towed with the clutch pedal completely depressed and then slowly release the clutch pedal. After the engine has started, immediately depress the clutch pedal again completely
5. Pull over at a suitable location, remove the tow bar or tow rope, and turn on the hazard warning flashers
6. Have the vehicle checked.

Vehicles with sequential manual gearbox SMG:

- ▷ Have the vehicle towed with the selector lever in position N
- ▷ Select sequential mode. The correct gear will automatically be selected and engaged.

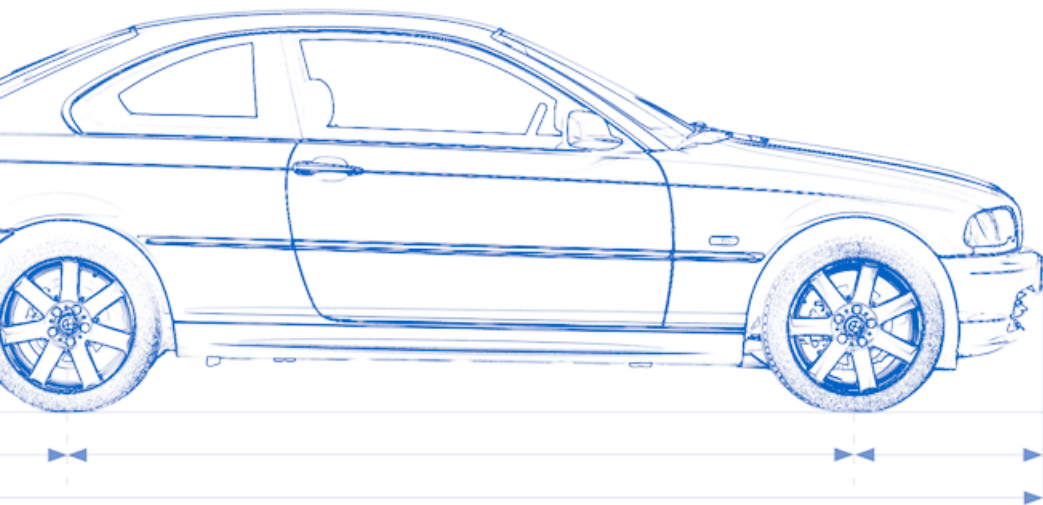

Overview

Controls and features

Operation, maintenance

Owner service procedures

Technical data

Index

Overview

Controls

Maintenance

Repairs

Data

Index

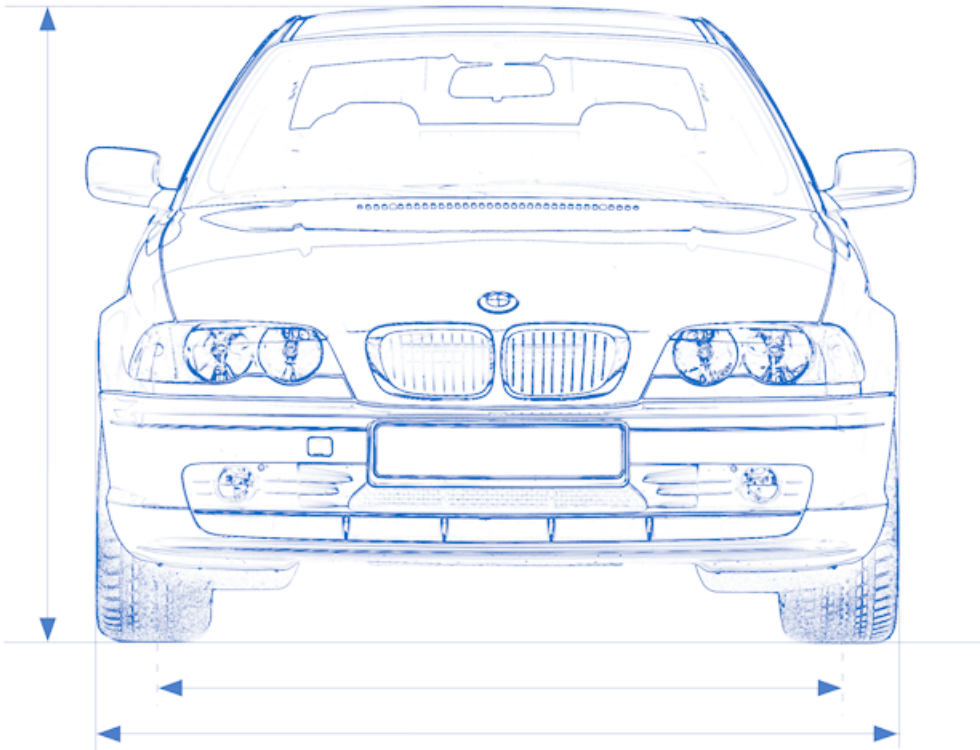

154 **Engine data**

		325Ci	330Ci
Displacement	cu in/cm ³	152.2/2,494	181.8/2,979
Number of cylinders		6	6
Maximum power output at engine speed	hp rpm	184 6,000	225 5,900
Maximum torque at engine speed	lb ft/Nm rpm	175/237 3,500	214/290 3,500

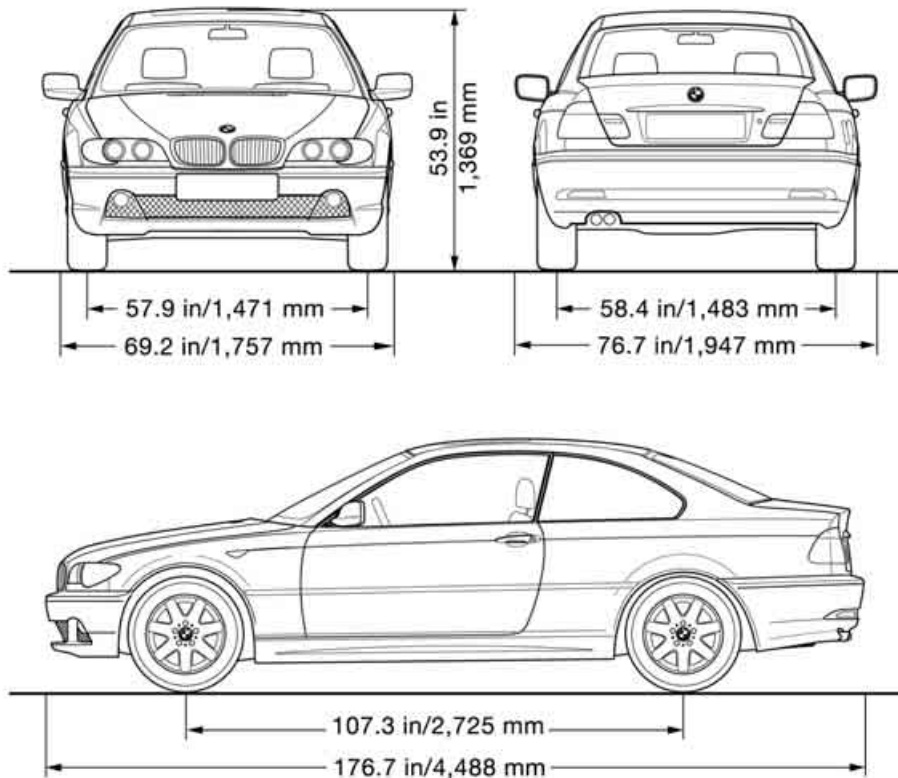

Minimum turning circle dia.: 34.4 feet/10.5 m.

		325Ci	330Ci
Curb weight			
with manual transmission/SMG	lbs/kg	3,197/1,450	3,285/1,490
with automatic transmission	lbs/kg	3,285/1,490	3,362/1,525
Approved gross vehicle weight			
with manual transmission/SMG	lbs/kg	4,255/1,930	4,343/1,970
with automatic transmission	lbs/kg	4,343/1,970	4,420/2,005
Approved front axle load			
	lbs/kg	1,984/900	2,006/910
Approved rear axle load			
	lbs/kg	2,425/1,100	2,469/1,120
Approved roof load capacity			
	lbs/kg	165/75	165/75
Luggage compartment capacity			
	cu ft/l	14.5/410	14.5/410

Approved axle loads and approved gross vehicle weight must never be exceeded.

			Notes
Fuel tank	gal./liters	approx. 16.6/63	Fuel specification, refer to 24
Reserve	gal./liters	approx. 2.1/8	
Windshield/ Headlamp washer reservoir	quarts/liters	approx. 5.6/5.3	Specifications, refer to page 126
Engine with oil filter change	quarts/liters	approx. 6.9/6.5	BMW High Performance Synthetic Oil Specifications, refer to page 126

A B C
P Q R



Overview

Controls and features

Operation, maintenance

Owner service procedures

Technical data

Index

Overview

Controls

Maintenance

Repairs

Data

Index

Everything from A to Z

A

ABS Antilock Brake System 115
indicator lamp 18

Acceleration assistant 66

Accessories, refer to For your own safety 5

Accident, refer to Emergency call 146

Activated-charcoal filter 98

Adaptive brake lamp, refer to Brake force display 84

Adaptive headlights 86

Adding brake fluid 129

Additional sources of information 4

Air conditioning 90

Air conditioning mode 92
automatic climate control 96

Air distribution
air conditioning 92
automatic climate control 96

Air distribution, individual 96

Air outlets, refer to Ventilation 90, 94

Air pressure, refer to Tire inflation pressure 116

Air recirculation, refer to Recirculated-air mode 92, 97

Air supply
air conditioning 92
automatic climate control 96

Air, drying, refer to Air conditioning mode 92, 96

Airbags 51
deactivating 54
indicator lamp 18, 53
sitting safely 41

Airing out, refer to Ventilation 90, 94

AKI, refer to Fuel specifications 24

Alarm system 36
avoiding unintentional alarms 37

All-season tires, refer to Winter tires 121, 122

Antifreeze 128
coolant 128
washer fluid 126

Antilock Brake System (ABS) 115
indicator lamp 18

Anti-theft system 28
Anti-theft warning system, refer to Alarm system 36

Approved axle loads, refer to Weights 156

Approved gross weight, refer to Weights 156

Armrest
front 100
rear 101

Artificial leather, refer to the Caring for your vehicle brochure

Ashtray
front 102
rear 102

Assistant systems, refer to Dynamic Stability Control (DSC) 81

AUC Automatic recirculated-air control 97

AUTO program 96

Automatic
cruise control 72
headlamp control 85

Automatic air distribution, refer to AUTO program 96

Automatic air supply, refer to AUTO program 96

Automatic car wash, refer to the Caring for your vehicle brochure

Automatic climate control 94

Automatic curb monitor 48

Automatic dimming, interior rearview mirror 50

Automatic recirculated-air control (AUC) 97

Automatic transmission with Steptronic 67
indicator lamp 19, 69
interlock 59
selector lever lock 67
shiftlock 67
tow-starting 150

Automatic windshield washer, refer to Rain sensor 71

Average fuel consumption 79

Average speed 79

Avoiding unintentional alarms 37

Axle loads, refer to Weights 156

B

Backrest
unlocking 45

Backrest, refer to Seat adjustment 42, 44

Backup lamps 62
bulb replacement 139

Bandages, refer to First-aid kit 22

Bar, for towing 149

- Battery 145
 - charge 145
 - charge current 18
 - disposal 145
 - indicator lamp 18
 - jump-starting 147
 - remote control 28, 29
- Belts, refer to Safety belts 46
- Beverage holders 100, 101
- Blower
 - air conditioning 92
 - automatic climate control 96
- BMW High Performance Synthetic Oils 127
- BMW Maintenance System 130
- BMW sports seat 43
- Bottle holders, see Beverage holders 100, 101
- Brake fluid 128
 - indicator lamp 18, 128
 - level 128
- Brake force display 84
- Brake lamps
 - bulb replacement 139
 - indicator lamp, defective lamp 76
- Brake lamps, refer to Brake force display 84
- Brake pads
 - brake fluid level 18, 129
 - breaking in 112
- Brake rotors
 - breaking in 112
- Brake system
 - brake pads, indicator lamp 19
- Brake wear warning indicator lamp 19
- Brakes
 - ABS 115
 - brake fluid 128
 - brake force display 84
 - brake pads 114
 - breaking in 112
 - driving notes 113
 - indicator/warning lamp 18, 19
 - parking brake 61
- Break-in procedures 112
- Bulb replacement, refer to Lamps and bulbs 137
- Bulb, replacing 137
- Buttons in steering wheel 21
- C**
- California laws
 - event data recorders 132
 - Proposition 65 warning 132
- Can holders, see Beverage holders 100, 101
- Capacities 157
- Car battery 145
- Car care, refer to the Caring for your vehicle brochure
- Car keys, refer to Keys 28
- Car radio, refer to the Owner's Manual for Radio
- Car telephone
 - preparation 101
- Car telephone, refer to the separate Owner's Manual
- Car vacuum cleaner, connecting 102
- Car wash, refer to the Caring for your vehicle brochure
- Carpet care, refer to the Caring for your vehicle brochure
- Cassette operation, refer to the Owner's Manual for Radio/Onboard Computer
- CBC Cornering Brake Control 115
 - warning lamp 18
- CD changer, refer to the Owner's Manual for Radio/Onboard Computer
- CD operation, refer to the Owner's Manual for Radio/Onboard Computer
- Center high-mount brake lamp
 - bulb replacement 140
- Central locking system 28
 - button 32
 - passenger compartment 32
- Charge indicator lamp 18
- Check Control 76
- Check Gas Cap
 - indicator lamp 19
- Child seats, refer to Child-restraint systems 54
- Child-restraint mounting system (LATCH) 56
- Child-restraint systems 54
- Chock 142
- Cigarette lighter 102
- Cleaning chrome parts, refer to the Caring for your vehicle brochure
- Cleaning light alloy wheels, refer to the Caring for your vehicle brochure
- Cleaning the vehicle, refer to the Caring for your vehicle brochure
- Cleaning windshield 72

Everything from A to Z

- Clock 77
 - 12-/24-hour mode 77
 - setting, refer also to the Owner's Manual for Radio/Onboard Computer
 - Closing
 - from inside 32
 - from outside 29
 - Clothes hooks 103
 - Clutch
 - breaking in 112
 - Cockpit 14
 - Code, refer to the Owner's Manual for Radio/Onboard Computer
 - Coin box 100
 - Cold start, refer to Starting the engine 59
 - Compact disc operation, refer to the Owner's Manual for Radio/Onboard Computer
 - Compartments 100
 - Computer 78
 - Condensation, refer to Air conditioning mode 92, 96
 - Configuring settings, refer to Vehicle Memory, Key Memory 58
 - Connecting a vacuum cleaner, refer to Power socket 102
 - Consumption
 - display 74
 - Consumption, refer to Average fuel consumption 79
 - Control elements, refer to Cockpit 14
 - Convenience operation
 - from outside 31
 - glass sunroof 30
 - windows 30
 - Coolant 128
 - indicator lamp 19, 75
 - level 128
 - temperature gauge 75
 - Coolant water, refer to Coolant 128
 - Cooling, refer to Temperature 92, 96
 - Copyright 4
 - Cornering Brake Control (CBC) 115
 - warning lamp 18
 - Cruise control 72
 - indicator lamp 20
 - Cup holders, see Beverage holders 100, 101
 - Curb weight, refer to Weights 156
 - Current consumption, refer to Energy control 74
 - Curve lighting, refer to Adaptive headlights 86
 - Cylinders, refer to Engine data 154
- ## D
- Dashboard, refer to Cockpit 14
 - Data
 - capacities 157
 - dimensions 155
 - engine 154
 - technical 154
 - weights 156
 - Daytime driving lamps 85
 - DBC Dynamic Brake Control 19, 115
 - Deep water, refer to Driving through water 113
 - Defrost position, refer to Defrosting windows 93, 96
 - Defrosting and demisting windows
 - air conditioning 93
 - automatic climate control 96
 - Defrosting windows 93, 96
 - Defrosting windshield, refer to Defrosting windows 93, 96
 - Demisting windows
 - air conditioning 93
 - automatic climate control 96
 - Differential
 - breaking in 112
 - Digital clock 77
 - Dimensions 155
 - Dipstick, engine oil 126
 - Displacement, refer to Engine data 154
 - Display lighting, refer to Instrument lighting 86
 - Displays, refer to Instrument cluster 16
 - Disposal
 - oil 127
 - vehicle battery 145
 - Distance warning, refer to Park Distance Control (PDC) 80
 - Divided rear backrest 104
 - Door key 28
 - Door lock 31
 - Doors
 - emergency operation 31
 - Draft-free ventilation 93, 97
 - Driving light, refer to Parking lamps/Low beams 85
 - Driving notes 113
 - Driving through water, deep water 113
 - Dry air, refer to Air conditioning mode 92, 96

DSC Dynamic Stability Control 81
 indicator lamp 19, 81

DTC Dynamic Traction Control 81
 indicator lamp 19, 81

Dynamic Brake Control (DBC) 19, 115
 indicator lamp 19

Dynamic Stability Control (DSC) 19, 81

Dynamic Traction Control (DTC) 81
 indicator lamp 19, 81

E

Easy entry, refer to Entering the rear 45

Electric glass sunroof 39

Electric power windows 38

Electrical accessories, failure 145

Electrical malfunction
 automatic transmission with Steptronic 69
 door lock 31
 driver's door 31
 fuel filler door 23
 glass sunroof 40
 luggage compartment lid 33

Electronic Stability Program (ESP), refer to Dynamic Stability Control (DSC) 81

Emergency call 146

Emergency operation
 doors 31
 driver's door 31
 fuel filler door 23
 glass sunroof 40

Emergency release
 luggage compartment lid 33, 35

Emissions, minimum, refer to Energy control 74

Energy control 74

Engine
 breaking in 112
 data 154
 electronics 19
 indicator lamp 19
 speed 74, 154
 starting 59
 switching off 61

Engine compartment 124

Engine coolant 128
 adding 128

Engine oil
 adding 127
 additives, refer to Adding engine oil 127
 capacity 157
 indicator/warning lamp 19
 quality 127
 specified oils 127

Engine oil consumption 126

Engine oil level 19
 check 126
 indicator/warning lamp 18

Engine oil pressure
 indicator/warning lamp 18

Engine oil types 127

Engine output, refer to Engine data 154

Engine speed 74, 154

Entering the rear 45

Environmentally-friendly driving, refer to Energy control 74

Equipment range, refer to Service and Warranty Information Booklet for US models/Warranty and Service Guide Booklet for Canadian models

ESP Electronic Stability Program, refer to Dynamic Stability Control (DSC) 81

Exterior mirrors 49

Eyeglasses
 compartment 101

Eyelets, towing and tow-starting 149

F

False alarm, refer to Avoiding unintentional alarms 37

Fasten safety belts
 indicator lamp 18

Fastening the safety belts 46

Fault displays 76

Filling the windshield washer reservoir 157

First aid, refer to First-aid kit 22

First-aid kit 22

Flashlight 100

Flashlight, refer to Rechargeable flashlight 100

Flat tire 141
 Flat Tire Monitor 82
 space-saver spare tire 141

Flat Tire Monitor 82
 indicator lamp 18, 19, 83

Fluid reservoir for washer systems 126

Folding rear backrest 104

Follow me home lamps 85

Everything from A to Z

Footbrake, refer to Braking
safely 113

Front airbags 51

Front center armrest 100

Front fog lamps 87
indicator lamp 20

Fuel
display 75
quality 24
volume 157

Fuel consumption
display 79

Fuel display, refer to Fuel
gauge 75

Fuel economy, refer to
Energy control 74

Fuel filler door 23
release following an elec-
trical malfunction 23

Fuel level indicator, refer to
Fuel gauge 75

Fuel reserve indicator, refer
to Fuel gauge 75

Fuel tank capacity 157

Fuses 145

G

Gasoline consumption, refer
to Average fuel consump-
tion 79

Gasoline, refer to Fuel spec-
ifications 24

Gear indicator 65, 69

Gear lever
automatic transmission
with Steptronic 67
sequential manual gear-
box SMG 63

Gearbox
manual transmission 62

Gearshift lever
manual transmission 62

General driving notes 113

Glass sunroof
closing following an elec-
trical malfunction 40
convenience operation
30, 31
remote control 29, 30

Glass sunroof, electric 39

Glove compartment 99

Grills, refer to Ventilation
90, 94

Gross weight, refer to
Weights 156

H

Handbrake, refer to Parking
brake 61

Hands-free system 101

Harman Kardon premium
sound system 99

Hazard warning flashers 14

Hazard warning triangle 22

Head airbags 51

Head restraints 45

Headlamp cleaning system
cleaning headlamps 72
washer fluid 126, 157

Headlamp control, auto-
matic 85

Headlamp flasher 87
indicator lamp 20

Headlamps
bulb replacement 137
care, refer to the Caring
for your vehicle brochure

Heated mirrors 49

Heated rear window
air conditioning 92
automatic climate
control 97

Heated seats 48

Heating
exterior mirrors 49
rear window 92, 97
seats 48

Heating and ventilation
90, 94

Heavy loads, refer to Cargo
loading 107

Height adjustment
seats 42, 44
steering wheel 50

Height, refer to
Dimensions 155

High beams 70, 87
bulb replacement 138
headlamp flasher 87
indicator lamp 20

Holder for
beverages 100, 101
litter bag 101

Hood release 123

Horn 14

Hub cap 142

Hydraulic brake assistant,
refer to DBC 115

Hydroplaning 113

I

Ice warning 78
Ignition 59

Ignition key 28
positions 59

Ignition lock 59

Imprint 4

Indicator lamps 18

Indicator/warning lamp

- airbags 18
 - alarm system 37
 - brakes 18, 19
 - Check Gas Cap 19
 - coolant 19, 75
 - DSC 19
 - Flat Tire Monitor 18, 19, 83
 - Please fasten safety belts 18
 - reserve 75
 - Service Engine Soon 19
- Individual air distribution 96
- Individual settings, refer to
Vehicle Memory, Key Memory 58
- Inflation pressure monitoring, refer to Flat Tire Monitor 82
- Inflation pressure, tires 116
- INSPECTION 76
- Instrument cluster 16
- Instrument lighting 86
- Instrument panel 14
- Interface socket for onboard diagnostics (OBD) 132
- Interior lamps 88
- remote control 30
- Interior motion sensor 37
- switching off 37

Interior rearview mirror 49

- automatic dimming feature 50
- Interior temperature
- adjusting 92, 96
- Interlock, refer to Steering wheel lock 59
- Intermittent mode, wipers 71
- Interval display, service 76

J

- Jack 141
- Jacking points 142
- Jump-starting 147

K

- Key Memory 58
- Keys 28
- with remote control 28
- Kickdown 64, 68

L

- Lamp defect 137
- Lamps and bulbs 137
- Lashing down loads, refer to
Cargo loading 106
- Lashing eyelets, refer to
Securing cargo 108
- Lashing fittings, refer to
Securing cargo 108
- LATCH child-restraint mounting system 56

Leather care, refer to the

- Caring for your vehicle brochure
- Leaving the vehicle 61
- LEDs, light-emitting diodes 141
- Length, refer to
Dimensions 155
- License plate lamp
- bulb replacement 141
- Light switch 85
- Light-emitting diodes (LEDs) 141
- Lighter 102
- LIGHTS ON warning 85
- Lights, refer to Parking lamps/Low beams 85
- Litter bag holder 101
- Load, determining the maximum 106
- Load, refer to Cargo loading 106
- Loading
- vehicle 106
- Load-securing devices 108
- Lock buttons on doors, refer to Locking 32
- Lock, steering wheel 59
- Locking
- from inside 32
 - from outside 29, 31

Locking and unlocking

- doors
 - from inside 32
 - from outside 29, 31
- Low beams 85
- automatic 85
 - bulb replacement 137
 - indicator lamp, defective lamp 76
- Lug bolts
- key 142
 - torque 142
- Luggage compartment
- capacity 156
 - emergency operation, refer to Manual operation 33
 - floor mat 36
 - floor panel 35
 - lid 33
 - opening from outside 33
 - opening, remote control 30
 - opening/closing, refer to Luggage compartment lid 33
 - remote control 30
 - volume 156

Everything from A to Z

Luggage compartment lid [33](#)
emergency operation [33](#)
emergency release [35](#)
indicator lamp [76](#)
opening from inside the vehicle [33](#)
opening from outside [33](#)
remote control [30](#)
securing separately [33](#)
unlocking manually [33](#)
Luggage compartment lighting [33](#)
Luggage rack, refer to Roof-mounted luggage rack [109](#)
Lumbar support [44](#)

M

Maintenance [76](#), [130](#)
Maintenance system [130](#)
Making telephone calls, refer to the telephone Owner's Manual
Malfunction
door lock [31](#)
fuel filler door [23](#)
Malfunction displays [76](#)

Manual operation
door lock [31](#)
driver's door [31](#)
fuel filler door [23](#)
glass sunroof [40](#)
luggage compartment lid [33](#)
Manual transmission [62](#)
Master keys
with remote control [28](#)
MC operation, refer to the Owner's Manual for Radio/Onboard Computer
MD operation, refer to the Owner's Manual for Radio/Onboard Computer
Mechanical seats [42](#)
Memory, refer to Seat and mirror memory [47](#)
Memory, refer to Vehicle Memory, Key Memory [58](#)
Microfilter
air conditioning [93](#)
automatic climate control [98](#)
Microphone [101](#)
Mini disc operation, refer to the Owner's Manual for Radio/Onboard Computer
Mirror
automatic curb monitor [48](#)

Mirrors [49](#)
heated [49](#)
memory, refer to Seat and mirror memory [47](#)
Mobile Service [147](#)
Modifications, technical, refer to For your own safety [5](#)
Multifunction steering wheel [21](#)
Multifunction switch
turn signal indicator/headlamp flasher [70](#)
washer/wiper system [71](#)

N

Navigation system, refer to the Owner's Manual for Radio/Onboard Computer
Neck restraints, refer to Head restraints [45](#)
Nets [100](#)
Nozzles, refer to Ventilation [90](#), [94](#)
Nylon rope, refer to Towing and tow-starting the vehicle [149](#)

O

OBD interface socket [132](#)
Odometer [74](#)

Oil

additives, refer to Adding engine oil [127](#)
capacity [157](#)
dipstick [126](#)
quality [127](#)
Oil change interval, refer to Service interval display [130](#)
Oil change intervals, refer to the Service and Warranty Information Booklet for US models/Warranty and Service Guide Booklet for Canadian models
Oil consumption [126](#)
Oil dipstick [126](#)
Oil filter change [157](#)
Oil level
checking [126](#)
indicator lamp [18](#)
Oil pressure
indicator lamp [18](#)
OIL SERVICE [76](#)
Oil types [127](#)
Old batteries, refer to Disposal [145](#)
Onboard computer [78](#)
Onboard computer, refer to the Owner's Manual for Onboard Computer
Onboard tool kit [136](#)

Opening and closing
 from inside [32](#)
 from outside [29](#)
 via door lock [31](#)
 via remote control [29](#)

Outlets, ventilation [90, 94](#)

Outside temperature display [78](#)
 changing unit of measure [78](#)

P

Paintwork care, refer to the Caring for your vehicle brochure

Panic mode – trigger alarm [30](#)

Park Distance Control (PDC) [80](#)

Parking aid, refer to Park Distance Control (PDC) [80](#)

Parking brake [61](#)
 indicator lamp [18](#)

Parking lamps [85](#)
 bulb replacement [138](#)

Parking lamps/Low beams [85](#)

Parts and accessories, refer to Your individual vehicle [5](#)

Passenger-side exterior mirror tilt function [48](#)

PDC Park Distance Control [80](#)

Plastic, refer to the Caring for your vehicle brochure

Pollen, refer to Microfilter [93](#)

Pollen, refer to Microfilter/activated-charcoal filter [98](#)

Power output, refer to Engine data [154](#)

Power seat [44](#)

Power socket [102](#)

Power socket, cigarette lighter [102](#)

Pressure monitoring, tires Flat Tire Monitor [82](#)

Pressure, tires [116](#)

Protective function electric power windows [38](#)

R

Radio remote control key, refer to Master key with remote control [28](#)

Radio, refer to the Owner's Manual for Radio

Rain sensor [71](#)

Raising the floor panel [35](#)

Range [79](#)

Reading lamps front [88](#)
 rear [88](#)

Rear armrest, refer to Rear center armrest [101](#)

Rear backrest, folding [104](#)

Rear center 3-point safety belt [104](#)

Rear center armrest [101](#)

Rear lamps bulb replacement [139](#)
 indicator lamp, defective lamp [76](#)

Rear window defroster air conditioning [92](#)

Rear window heating automatic climate control [97](#)

Rear-entry assist [45](#)

Rearview mirror [49](#)

Receiving assistance [146](#)

Recirculated-air mode air conditioning [92](#)
 automatic climate control [97](#)

Recirculating the air, refer to Recirculated-air mode [92, 97](#)

Reclining seat, refer to Seat adjustment [42, 44](#)

Refueling [23](#)
 fuel filler door [23](#)

Releasing hood [123](#)

Remaining distance to service [76](#)

Remaining distance, refer to Range [79](#)

Remote control [29](#)
 luggage compartment lid [30](#)
 malfunction [30](#)

Replacement key [29](#)

Replacing lamps, refer to Lamps and bulbs [137](#)

Reporting safety defects [7](#)

Restraint systems for children [54](#)

Restraint systems, refer to Safety belts [46](#)

Reverse [62](#)
 automatic transmission with Steptronic [67](#)

SMG gearbox [64](#)

Roof load capacity [156](#)

Roof-mounted luggage rack [109](#)

Rope, refer to Towing and tow-starting the vehicle [149](#)

Run Flat tires [120](#)

S

Safe seating position [41](#)
 Safety belt height adjustment [46](#)

Everything from A to Z

- Safety belts [46](#)
 - sitting safely [41](#)
 - warning lamp [18](#)
 - Safety feature
 - glass sunroof [40](#)
 - Safety systems, refer to
 - Antilock Brake System [115](#)
 - Dynamic Stability Control (DSC) [81](#)
 - Screwdriver, refer to
 - Onboard tool kit [136](#)
 - Seat adjustment [42](#)
 - BMW sports seat [43](#)
 - mechanical [42](#)
 - power [44](#)
 - Seat belt tensioner, refer to
 - Safety belts [46](#)
 - Seat heating [48](#)
 - Seat memory, refer to Seat and mirror memory [47](#)
 - Seat positions, storing [47](#)
 - Seats [42](#)
 - Securing cargo [108](#)
 - Securing the vehicle
 - from inside [32](#)
 - from outside [29, 31](#)
 - Selector lever
 - automatic transmission [67](#)
 - sequential manual gearbox SMG [63](#)
 - Selector lever lock, refer to Shiftlock [63, 67](#)
 - Selector lever positions
 - automatic transmission [67](#)
 - sequential manual gearbox SMG [63](#)
 - Sequential manual gearbox SMG [63](#)
 - indicator lamp [19](#)
 - Service and Warranty Information Booklet [130](#)
 - Service Engine Soon warning lamp [19](#)
 - Service interval display [76, 130](#)
 - Shift paddles [64](#)
 - Shifting gears
 - automatic transmission with Steptronic [67](#)
 - sequential manual gearbox SMG [64](#)
 - Shiftlock [63](#)
 - Shiftlock, refer to Range selection [67](#)
 - Side airbags [51](#)
 - Side turn signal indicators
 - bulb replacement [139](#)
 - Sitting safely
 - with airbags [41](#)
 - with safety belts [41](#)
 - Size [155](#)
 - Ski bag [105](#)
 - Sliding/tilt sunroof, refer to
 - Electric glass sunroof [39](#)
 - SMG sequential manual gearbox [63](#)
 - indicator lamp [19](#)
 - Smokers' package, refer to Ashtray [102](#)
 - SOS, refer to Emergency call [146](#)
 - Space-saver spare tire [144](#)
 - changing a wheel [141](#)
 - Spare key [28](#)
 - Spare tire [141](#)
 - Spare wheel [144](#)
 - Special oils [127](#)
 - Specified oils [127](#)
 - Speed gauge, refer to
 - Speedometer [16](#)
 - Speedometer [16](#)
 - SPORT button [66](#)
 - Sport program
 - automatic transmission with Steptronic [68](#)
 - Sports seat [43](#)
 - Stability control, refer to
 - Dynamic Stability Control (DSC) [81](#)
 - Standing lamps [87](#)
 - Starting difficulties
 - jump-starting [147](#)
 - temperature [59](#)
 - Starting help DSC [81](#)
 - Starting the engine [59](#)
 - Starting, refer to Starting the engine [59](#)
 - Status of the Owner's Manual [5](#)
 - Steering wheel lock [59](#)
 - Steering wheel, adjusting [50](#)
 - Steptronic, refer to Manual operation [68](#)
 - Storage compartments [100](#)
 - Storage nets [100](#)
 - Storage, refer to the Caring for your vehicle brochure
 - Storing seat positions, refer to Seat and mirror memory [47](#)
 - Storing tires [122](#)
 - Sun blind [98](#)
 - Sun blind, refer to Roller sun blind [98](#)
 - Surface ice, refer to Ice warning [78](#)
 - Switches, refer to
 - Cockpit [14](#)
 - Switching off vehicle [61](#)
 - Symbols [4](#)
 - Synthetic oils [127](#)
- ## T
- Tachometer [74](#)

- Tail lamps
 - bulb replacement [139](#)
- Tail lamps, refer to Rear lamps [139](#)
- Tank capacity, refer to Fuel tank capacity [157](#)
- Tank indicator, refer to Fuel gauge [75](#)
- Technical data [154](#)
- Technical modifications [5](#)
- Technical modifications, refer to For your own safety [5](#)
- Telephone hookup [101](#)
- Telephone, refer to the separate Owner's Manual
- Television, refer to the Owner's Manual for Onboard Computer
- Temperature
 - air conditioning [92](#)
 - automatic climate control [96](#)
- Temperature adjustment [92](#), [96](#)
- Temperature display
 - engine coolant [75](#)
 - ice warning [78](#)
 - outside temperature [78](#)
 - setting units [78](#)
- Temperature layering [93](#), [97](#)
- Tempomat, refer to Cruise control [72](#)
- Thigh support area, adjusting [43](#)
- Third brake lamp, refer to Center high-mount brake lamp [140](#)
- Threaded socket for towing eyelet [149](#)
- Three-point safety belt [46](#)
- Through-loading system [104](#)
- Tilt alarm
 - deactivate [37](#)
- Tilt alarm sensor [37](#)
- Tilting passenger-side exterior mirror [48](#)
- Time [77](#)
- Tire change [141](#)
- Tire inflation pressure [116](#)
- Tire pressure monitoring, refer to Flat Tire Monitor [82](#)
- Tire replacement [141](#)
- Tires
 - age [118](#)
 - breaking in [112](#)
 - changing [141](#)
 - condition [119](#)
 - damage [119](#)
 - flat [141](#)
 - inflation pressure [116](#)
 - storing [122](#)
 - tread [119](#), [120](#)
 - tread wear indicators, refer to Tire tread [120](#)
 - winter tires [121](#), [122](#)
- Tools, refer to Onboard tool kit [136](#)
- Torque
 - engine [154](#)
 - lug bolts [142](#)
- Tow bar [149](#)
- Tow rope [149](#)
- Towing [149](#)
- Towing eyelet [149](#)
- Towing the vehicle [149](#)
- Tow-starting [149](#)
- Track width, refer to Dimensions [155](#)
- Transmission
 - automatic transmission with Steptronic [67](#)
 - sequential manual gear-box SMG [63](#)
- Transmission lock, refer to P Park [67](#)
- Transmission malfunction
 - automatic transmission with Steptronic [69](#)
 - sequential manual gear-box SMG [65](#)
- Transport securing devices, refer to Securing cargo [108](#)
- Transporting children safely [54](#)
- Trap protection
 - electric power windows [38](#)
 - glass sunroof [40](#)
- Tread depth, refer to Tire tread [120](#)
- Tread wear indicators in the tires, refer to Tire tread [120](#)
- Tread wear, tires [120](#)
- Trigger alarm – Panic mode [30](#)
- Trip distance recorder, refer to Trip odometer [74](#)
- Trip meter, refer to Trip odometer [74](#)
- Trip odometer [74](#)
- Trunk lid, refer to Luggage compartment lid [33](#)

Everything from A to Z

Trunk lighting, refer to Luggage compartment lighting [33](#)

Turn signal indicator
bulb replacement [139](#)
indicator lamp [20](#)

Turn signal indicator, side
bulb replacement [139](#)

Turn signal indicators [70](#)

Turning circle, refer to
Dimensions [155](#)

TV function, refer to the
Owner's Manual for
Onboard Computer

U

Underbody protection, refer
to the Caring for your vehicle
brochure

Units
average fuel
consumption [79](#)
temperature [78](#)

Unlocking
from inside [32](#)
from outside [29, 31](#)

V

Valve
screw caps [142](#)

Vehicle
battery [145](#)
break-in procedures [112](#)
dimensions [155](#)
leaving the vehicle [61](#)
loading [106](#)
starting [59](#)
washing, refer to the Caring
for your vehicle brochure
[71](#)
weight [156](#)

Vehicle Memory [58](#)

Vehicle storage, refer to the
Caring for your vehicle
brochure

Vehicle weight [156](#)

Ventilation [90, 94](#)
draft-free [93, 97](#)

Viscosity [127](#)

Voice Input System [21, 101](#)

Voice recognition, refer to
separate Owner's Manual

Volume
luggage compartment [156](#)

W

Warning and indicator
lamps [18](#)

Warning lamp
Please fasten safety
belts [18](#)

Warning messages [76](#)

Warranty and Service Guide
Booklet [130](#)

Warranty, refer also to separate
booklet [6](#)

Washer fluid
adding [126, 157](#)

Washer fluid reservoir [126](#)
volume [126](#)

Washer jets, refer to Windshield
washer jets [72](#)

Washer/wiper system [71, 72](#)
washer fluid [126](#)

Waste tray, refer to
Ashtray [102](#)

Weights [156](#)

Wheelbase, refer to Dimensions
[155](#)

Wheels and tires [116](#)

Wheel slip control DSC [81](#)

Width, refer to
Dimensions [155](#)

Window condensation
removing [93, 96](#)

Windows
convenience operation
[30, 31](#)
power [38](#)
remote control [29, 30](#)

Windshield washer
nozzles [72](#)

Windshield washer reservoir
volume, see
Capacities [157](#)

Windshield wipers, refer to
Washer/wiper system [71](#)

Winter tires [121, 122](#)
storing [122](#)

Wiper blades
replacing [136](#)

Work in the engine compartment
[123](#)

Wrench, refer to Onboard
tool kit [136](#)

X

Xenon lamps
bulb replacement [138](#)

Refueling



To ensure that you always have convenient access to all essential information when you stop for fuel, we recommend that you fill out the adjoining chart by entering the data that apply to your vehicle. Consult the index for individual specifications.

Fuel

Designation	
-------------	--

Please enter your preferred fuel here.

Engine oil

Quality	
---------	--

The oil volume between the two marks on the dipstick corresponds to approx. 1.1 US quarts/1 liter.

Tire inflation pressure

	Summer tires		Winter tires	
	Front	Rear	Front	Rear
Up to 4 persons				
5 persons or 4 plus luggage				

More about BMW

bmwusa.com



The Ultimate
Driving Machine