

Owner's Manual
for Vehicle



The Ultimate
Driving Machine



M6 Owner's Manual for Vehicle

Congratulations, and thank you for choosing a BMW M6.

Thorough familiarity with your vehicle will provide you with enhanced control and security when you drive it. We therefore have this request:

Please take the time to read this Owner's Manual and familiarize yourself with the information that we have compiled for you before starting off in your new vehicle. It contains important data and instructions intended to assist you in gaining maximum use and satisfaction from your BMW M6's unique range of technical features. The manual also contains information on maintenance designed to enhance operating safety and contribute to maintaining the value of your BMW M6 throughout an extended service life.

This manual is supplemented by a Service and Warranty Information Booklet for US models or a Warranty and Service Guide Booklet for Canadian models.

We wish you an enjoyable driving experience.

BMW AG

© 2007 Bayerische Motoren Werke
Aktiengesellschaft
Munich, Germany
Reprinting, including excerpts,
only with the written consent of
BMW AG, Munich.
Order No. 01 41 0 013 314
US English II/07, 07 03 510
Printed in Germany
Printed on environmentally friendly paper,
bleached without chlorine, suitable for recycling.

Contents

The fastest way to find specific topics is to use the index, refer to page 234.

Using this Owner's Manual

- 4 Notes
- 7 Reporting safety defects

At a glance

- 10 Cockpit
- 16 iDrive
- 22 Voice command system

Controls

- 28 Opening and closing
- 46 Adjusting
- 56 Transporting children safely
- 58 Driving
- 68 Everything under control
- 80 Technology for comfort, convenience and safety
- 95 Lamps
- 99 Climate
- 105 Practical interior accessories

Driving tips

- 114 Things to remember when driving

Navigation

- 122 Starting navigation system
- 124 Destination entry
- 136 Destination guidance
- 145 What to do if ...

Entertainment

- 148 On/off and tone
- 152 Radio
- 161 CD player and CD changer
- 167 AUX-In connection

Communications

- 170 Telephoning
- 185 BMW Assist

Mobility

- 194 Refueling
- 196 Wheels and tires
- 202 Under the hood
- 207 Maintenance
- 209 Replacing components
- 219 Giving and receiving assistance

Reference

- 226 Technical data
- 229 Short commands of voice command system
- 234 Everything from A to Z

Notes

Using this Owner's Manual

We have made every effort to ensure that you are able to find what you need in this Owner's Manual as quickly as possible. The fastest way to find specific topics is to use the detailed index at the back of the manual. If you wish to gain an initial overview of your vehicle, you will find this in the first chapter.

Should you want to sell your BMW some day, please remember to pass on the Owner's Manual as well; it is an important component of your vehicle.

Additional sources of information

Should you have any other questions, your BMW center will be glad to advise you at any time.

You can find information on BMW, e.g. technology, on the Internet at www.bmwusa.com.

Symbols used



Indicates precautions that must be followed precisely in order to avoid the possibility of personal injury and serious damage to the vehicle. ◀



Indicates information that will assist you in gaining the optimum benefit from your vehicle and enable you to care more effectively for your vehicle. ◀



Refers to measures that can be taken to help protect the environment. ◀

◀ Marks the end of a specific item of information.

* Indicates special equipment, country-specific equipment and optional extras, as well as equipment and functions not yet available at the time of printing.

"..." Identifies Control Display texts used to select individual functions.

›...‹ Verbal instructions to use with the voice command system.

››...‹‹ Identifies the answers generated by the voice command system.

Symbols on vehicle components



Indicates that you should consult the relevant section of this Owner's Manual for information on a particular part or assembly.

The individual vehicle

When purchasing your BMW, you have decided in favor of a model with individualized equipment and features. This Owner's Manual describes all equipment offered for the BMW M6.

Please bear in mind that the manual may contain information on accessories and equipment that you have not specified for your own vehicle. Sections describing options and special equipment are marked by asterisks * to assist you in identifying possible differences between the descriptions in this manual and your own vehicle's equipment.

If equipment in your BMW is not described in this Owner's Manual, please refer to the accompanying Supplementary Owner's Manuals.

Editorial notice

BMW pursues a policy of continuous, ongoing development that is conceived to ensure that our vehicles continue to embody the highest quality and safety standards combined with advanced, state-of-the-art technology. In isolated cases it is possible that the features described in this Owner's Manual could differ from those on your vehicle.

For your own safety

Maintenance and repairs

 Advanced technology, e.g. the use of modern materials and high-performance electronics, requires specially adapted maintenance and repair methods. Have corresponding work on your BMW performed only by your BMW center or a workshop that works according to BMW repair procedures with appropriately trained personnel. If this work is not carried out properly, there is a danger of subsequent damage and related safety hazards. ◀

California Proposition 65 Warning

California law requires us to issue the following warning:

 Engine exhaust and a wide variety of automobile components and parts, including components found in the interior furnishings in a vehicle, contain or emit chemicals known to the State of California to cause cancer and birth defects and reproductive harm. In addition, certain fluids contained in vehicles and certain products of component wear contain or emit chemicals known to the State of California to cause cancer and birth defects or other reproductive harm.

Battery posts, terminals and related accessories contain lead and lead compounds. Wash your hands after handling.

Used engine oil contains chemicals that have caused cancer in laboratory animals. Always protect your skin by washing thoroughly with soap and water. ◀

Parts and accessories

 For your own safety, use genuine parts and accessories approved by BMW.

When you purchase accessories tested and approved by BMW and Genuine BMW Parts, you simultaneously acquire the assurance that they have been thoroughly tested by BMW to ensure optimum performance when installed on your vehicle.

BMW warrants these parts to be free from defects in material and workmanship.

BMW will not accept any liability for damage resulting from installation of parts and accessories not approved by BMW.

BMW cannot test every product made by other manufacturers to verify if it can be used on a BMW safely and without risk to either the vehicle, its operation, or its occupants.

Genuine BMW Parts, BMW Accessories and other products approved by BMW, together with professional advice on using these items, are available from all BMW centers.

Installation and operation of non-BMW approved accessories such as alarms, radios, amplifiers, radar detectors, wheels, suspension components, brake dust shields, telephones, including operation of any mobile phone from within the vehicle without using an externally mounted antenna, or transceiver equipment, for instance, CBs, walkie-talkies, ham radios or similar accessories, may cause extensive damage to the vehicle, compromise its safety, interfere with the vehicle's electrical system or affect the validity of the BMW Limited Warranty. See your BMW center for additional information. ◀

 Maintenance, replacement, or repair of the emission control devices and systems may be performed by any automotive repair establishment or individual using any certified automotive part. ◀

Service and warranty

We recommend that you read this publication thoroughly.

Your BMW is covered by the following warranties:

- ▷ New Vehicle Limited Warranty
- ▷ Rust Perforation Limited Warranty
- ▷ Federal Emissions System Defect Warranty
- ▷ Federal Emissions Performance Warranty
- ▷ California Emission Control System Limited Warranty

Detailed information about these warranties is listed in the Service and Warranty Information Booklet for US models or in the Warranty and Service Guide Booklet for Canadian models.

Reporting safety defects

For US customers

The following applies only to vehicles owned and operated in the US.

If you believe that your vehicle has a defect which could cause a crash or could cause injury or death, you should immediately inform the National Highway Traffic Safety Administration (NHTSA) in addition to notifying BMW of North America, LLC, P.O. Box 1227, Westwood, New Jersey 07675-1227, Telephone (800) 831-1117.

If NHTSA receives similar complaints, it may open an investigation, and if it finds that a safety defect exists in a group of vehicles, it may order a recall and remedy campaign. However, NHTSA cannot become involved in individual problems between you and your dealer or BMW of North America, LLC.

To contact NHTSA, you may call the Vehicle Safety Hotline toll-free at 1-888-327-4236 (TTY: 1-800-424-9153); go to <http://www.safercar.gov>; or write to: Administrator, NHTSA, 400 Seventh Street, SW., Washington, DC 20590. You can also obtain other information about motor vehicle safety from <http://www.safercar.gov>

For Canadian customers

Canadian customers who wish to report a safety-related defect to Transport Canada, Defect Investigations and Recalls, may call 1-800-333-0510 toll-free from anywhere in Canada or 1-613-993-9851 from the Ottawa region and from other countries, or contact Transport Canada by mail at: Transport Canada, ASFAD, Place de Ville, Tower C, 330 Sparks Street, Ottawa, ON, K1A 0N5. You can also obtain other information about motor vehicle safety from <http://www.tc.gc.ca>



A blurred, blue-tinted image of a car, likely a sedan, is the background of the page. The car is out of focus, with its headlights and front wheel visible. The overall color scheme is a gradient of blues, from light to dark.

At a glance



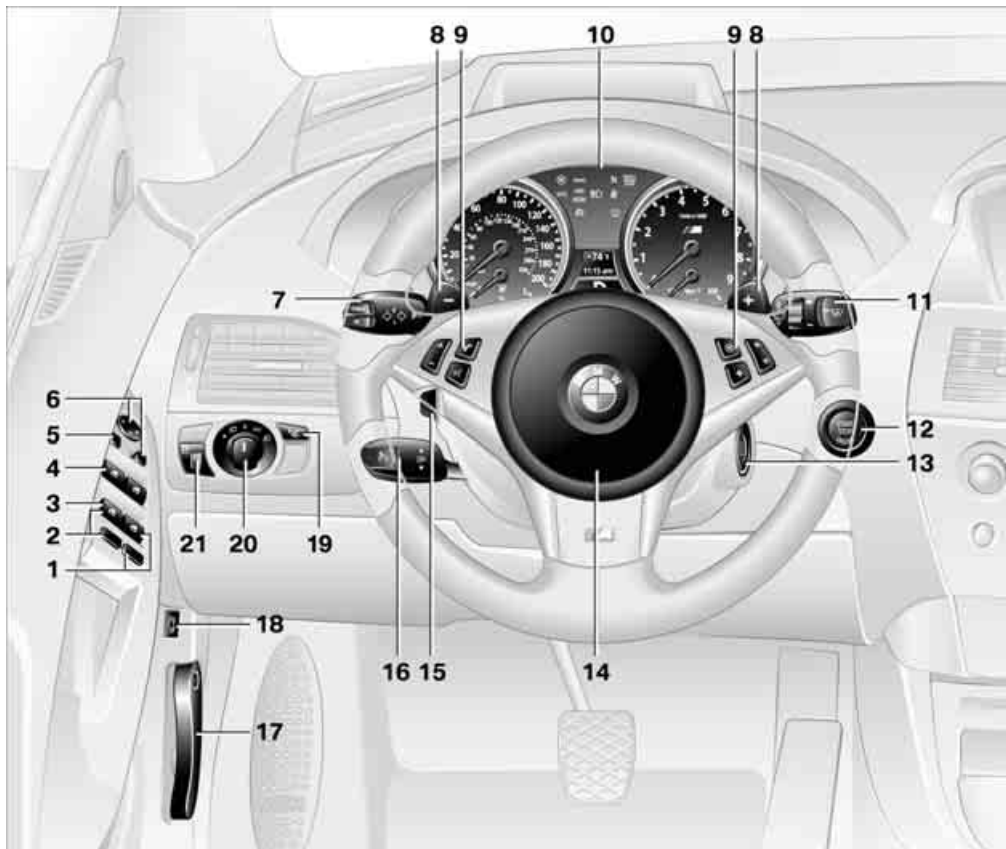

This overview of buttons, switches and displays is intended to familiarize you with your vehicle's operating environment. The section will also assist you in becoming acquainted with the control concepts and options available for operating the various systems.

Cockpit

Around the steering wheel: controls and displays



- 1 Convertible: opening and closing rear window [39](#)
- 2 Convertible: opening and closing windows together [39](#)
- 3 Convertible: opening and closing rear windows [39](#)
- 4 Opening and closing front windows [38](#)
- 5 Folding exterior mirrors in and out* [52](#)
- 6 Adjusting exterior mirrors [52](#)
Automatic curb monitor [52](#)

- 7  Turn signals [64](#)
-  High beams, headlamp flasher [97](#)
-  Roadside parking lamps [97](#)
-  CHECK Check Control [73](#)
-  BC Computer [69](#)

- 8 Shift paddles [62](#)

9 Buttons on steering wheel



Mobile phone* [171](#)

- ▶ Press: accepting and ending call, starting dialing* for selected phone number and redialing if no phone number is selected

- ▶ Press and hold: redialing



Volume



Activating/deactivating voice command system* [22](#)



Changing radio station [152](#)



Selecting music track [162](#)



Scrolling in phone book and in lists with stored phone numbers



MDrive, call up individual settings [54](#)



Individually programmable [53](#)

10 Instrument cluster [12](#)

11



Windshield wipers [65](#)



Rain sensor [65](#)

12



Starting/stopping engine and switching ignition on/off [58](#)

13 Ignition lock [58](#)

14 Horn, entire surface

15



Steering wheel adjustment [53](#)

16



Cruise control [66](#)

17 Releasing hood [202](#)

18 Opening luggage compartment lid [34](#)

19



Head-Up Display* [91](#)

20



Parking lamps [95](#)



Low beams [95](#)



Daytime running lamps* [96](#)



Automatic headlamp control [95](#)

Daytime running lamps* [96](#)

Adaptive Head Light* [96](#)

21



Instrument lighting [97](#)

Instrument cluster

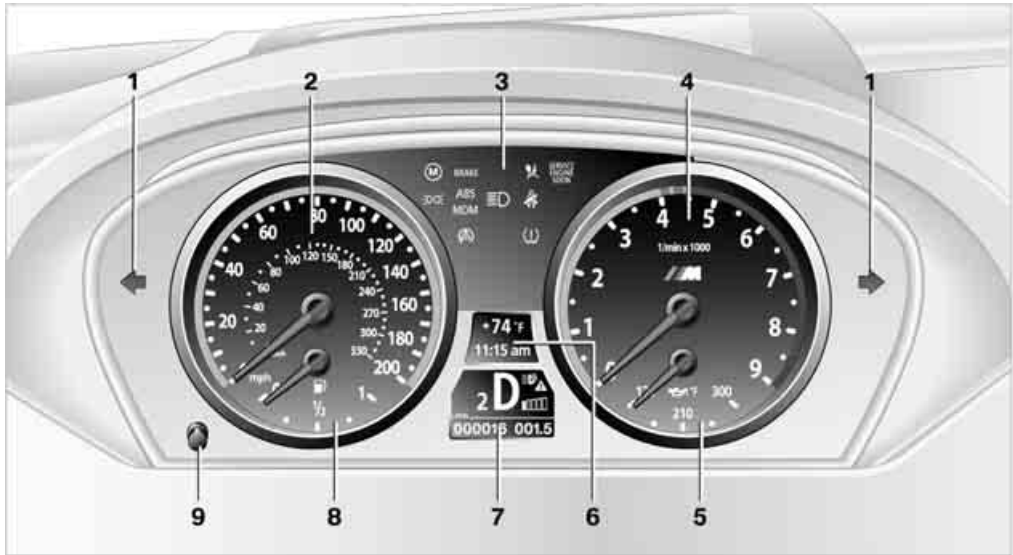

vwchassis.com

- 1 Indicator lamps for turn signals
- 2 Speedometer
- 3 Indicator and warning lamps [13](#)
- 4 Tachometer [68](#)
- 5 Engine oil thermometer [69](#)
- 6 Display for
 - ▷ Computer [69](#)
 - Engine oil level [203](#)
 - ▷ Indicator and warning lamps [73](#)
 - ▷ Speed of cruise control [67](#)
- 7 Display for
 - ▷ Sequential Manual Transmission with Drivelogic [62](#)
 - ▷ Engine oil level for manual transmission [203](#)
 - ▷ Check Control message present [73](#)
 - ▷ Odometer and trip odometer [68](#)
 - ▷ Date and remaining distance to be driven for service requirements [71](#)
- 8 Fuel gauge [69](#)
- 9 Resetting trip odometer [68](#)

Indicator and warning lamps

The concept



The indicator and warning lamps can light up in different combinations and colors.

When the engine is started or the ignition is switched on, some lamps are checked for proper operation and light up briefly in the process.

Explanatory text messages



Text messages at the bottom edge of the Control Display explain the meaning of the indicator and warning lamps displayed.

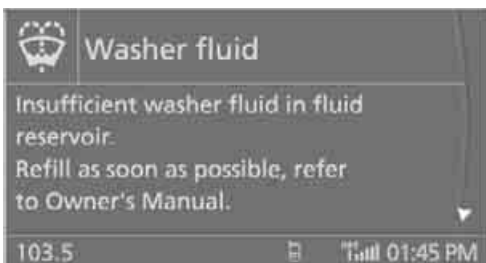







You can consult Check Control for additional information, e.g. regarding the cause of a malfunction or the appropriate actions to take, refer to page 73.

In urgent cases, this information will be shown as soon as the corresponding lamp lights up.

Indicator lamps without text messages

The following indicator lamps indicate that certain functions are activated or deactivated:

-  MDrive 54
-  Handbrake applied 60
-  Handbrake applied for Canadian models
-  Parking lamps/low beams 95
-  M Dynamic Mode 82
-  High beams/headlamp flasher 97
-  Lamp flashes:
DSC controls the drive and braking forces for maintaining vehicle stability 82

Around the center console: controls and displays

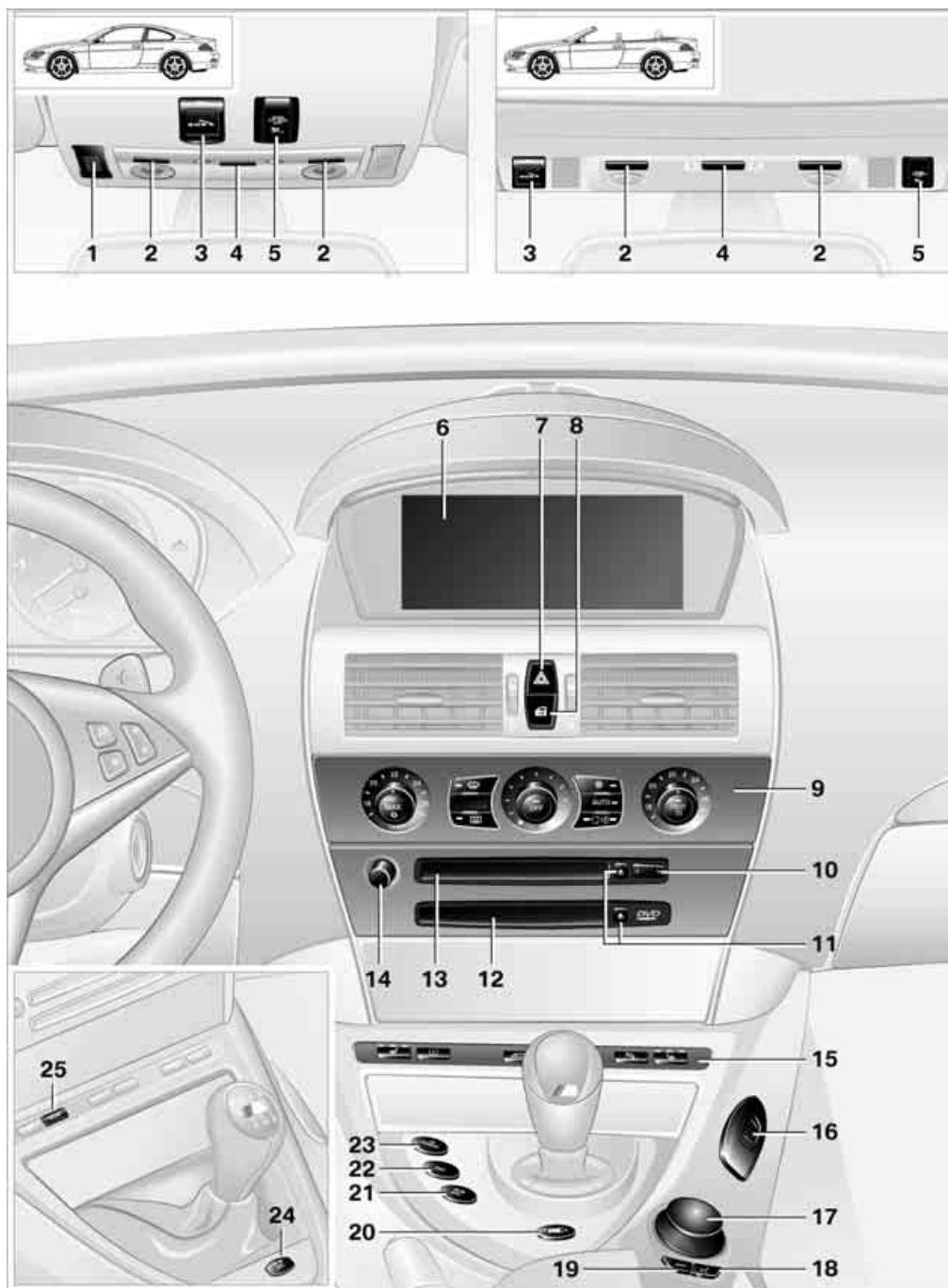

- 1 Microphone for hands-free mode for telephone* and voice command system* 22
Convertible: microphone on steering column
- 2 Reading lamps 98
- 3 SOS: initiating an emergency call 219
- 4 Interior lamps 97
- 5 Passenger airbag status lamp 90
- 6 Control Display 16
- 7 Hazard warning flashers
- 8 Central locking system 32
- 9 Automatic climate control 99

 Temperature setting, left/right 99

 Automatic air distribution and volume 100

 Cooling function 101

 AUC Automatic recirculated-air control 102

 Recirculated-air mode 102

 Maximum cooling 102

 Residual heat mode 102

 Switching off automatic climate control 102

 Air volume 101

 Defrosting windows and removing condensation 101

 Rear window defroster 99

10 Changing

- ▷ radio station 162 162
- ▷ Track 162 162

11 Ejecting

- ▷ navigation DVD* 122
- ▷ audio CD 162 162

12 Drive for navigation DVD in Professional* navigation system 122

13 Drive for audio CDs 162 162

14 Entertainment sound output on/off and adjusting volume 162 162

15  Heated seats 51

 PDC Park Distance Control* 80

 Flat Tire Monitor 84

 Convertible: opening the convertible top 41

 Convertible: closing the convertible top 41

16 Bracket for cup holder* 108

17 Controller 16
Turn, press or move horizontally in four directions

18 Activating voice command system* 22

19 Opening start menu on Control Display 17

20 Drivelogic of Sequential Manual Transmission 62

21 EDC Electronic Damper Control for Sequential Manual Transmission 84

22 DSC Dynamic Stability Control for Sequential Manual Transmission 82

23 M Engine Dynamic Control POWER for Sequential Manual Transmission 64

24 EDC Electronic Damper Control for manual transmission* 84

25 MDM M Dynamic Mode for manual transmission 82

iDrive combines the functions of a multitude of switches. This allows these functions to be operated from a central position. The following section provides an introduction to basic menu

navigation. The control of individual functions is described in connection with the relevant equipment.

Controls

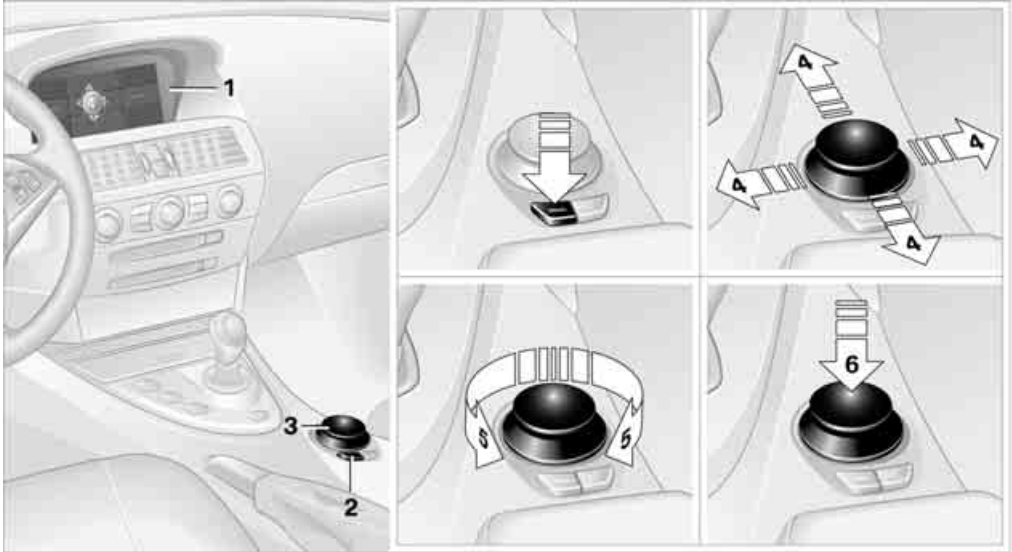

- 1 Control Display
- 2 **MENU** button
Opening the start menu
- 3 Controller
You can use the controller to select menu items and change settings by:
 - ▷ moving in four directions, arrows **4**
 - ▷ turning, arrow **5**
 - ▷ pressing, arrow **6**

⚠ To avoid becoming distracted and unnecessarily endangering both your own vehicle's occupants and other road users, never attempt to use the controls or make entries unless traffic and road conditions allow. ◀

Menu overview

Communication

- ▷ Telephone*
- ▷ BMW Assist* or TeleService*

Navigation or onboard information

- ▷ Navigation system*
- ▷ Onboard info, e.g. for displaying of the average fuel consumption

Entertainment

- ▷ Radio
- ▷ CD player and CD changer*

Climate

- ▷ Vent settings
- ▷ Automatic programs
- ▷ Parked car operation

i menu

- ▷ Switching off the Control Display
- ▷ Tone and display settings
- ▷ Settings for your vehicle, e.g. for MDrive, or settings for the central locking system
- ▷ Display of maintenance intervals and deadlines for legally mandated inspections
- ▷ Settings for the telephone

Basic operation

From radio readiness, refer to page 58, the following message is shown on the Control Display:

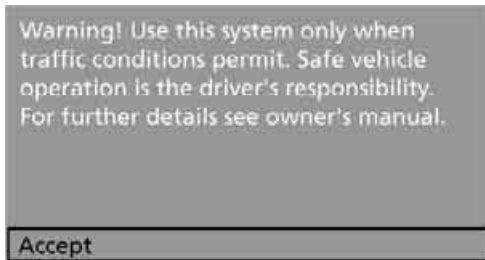

To hide the message:
Press the controller.
This displays the start menu.

The message is automatically hidden after approx. 10 seconds.

Start menu



You can call up all the functions of iDrive using five menu items.

Opening start menu

Press the **MENU** button.

To open the start menu from the **i** menu:

Press the **MENU** button twice.

Opening menu items of start menu

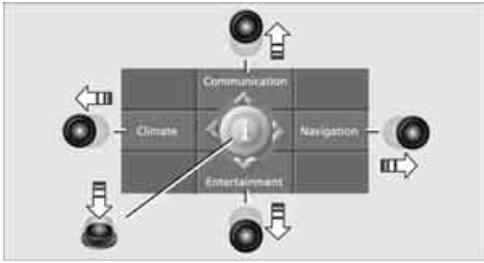

From the start menu, you can call up the four menu items Communication, Navigation, Entertainment, and Climate by moving the controller left, right, forward, or back.

You can open the **i** menu by pressing the controller.

Comfort opening of menu items

Comfort opening offers you the option of:

- ▶ Opening a menu item of the start menu in the view last selected
- ▶ Direct changing between Communication, Navigation, Entertainment and Climate without pressing the **MENU** button

To do so, move the controller in the corresponding direction and hold it for longer than approx. 2 seconds.

Displays in menu

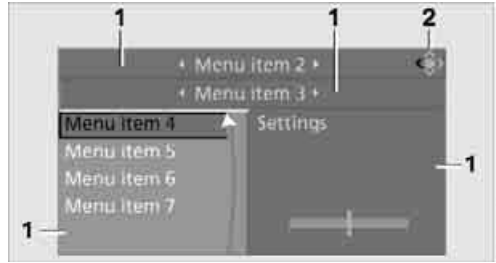

- 1 Each menu is divided into fields. The currently selected field appears brighter.
- 2 A symbol indicates the last selected menu item of the start menu:

- Communication
- Navigation or onboard info
- Entertainment
- Climate
- i** menu

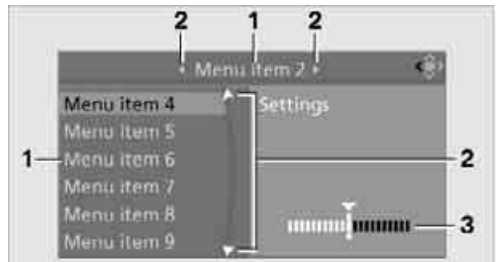

- 1 Menu items are usually grouped in horizontal or vertical lists.
- 2 Arrows indicate the possibility of accessing other menu items that are not currently visible.
- 3 Settings are displayed graphically or numerically.

Operating principle at a glance

Basic operation via iDrive is described in this view.

You can view the individual steps under Settings on Control Display, Setting time, refer to page 77.

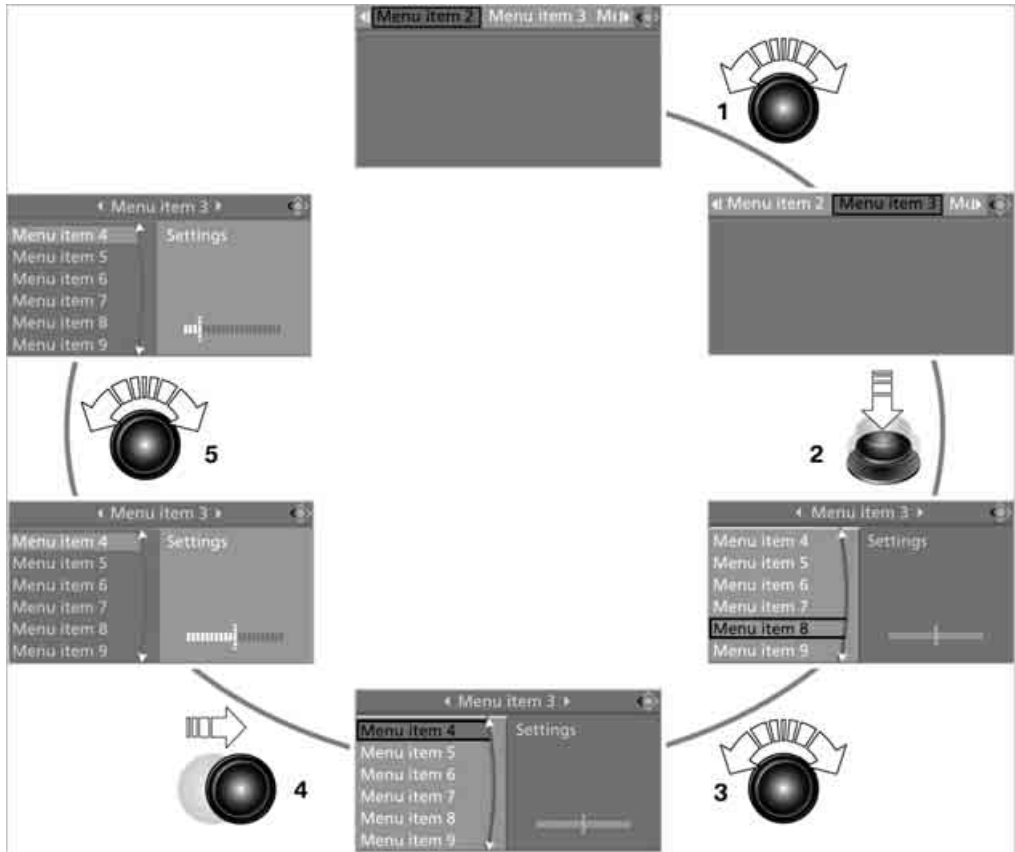

- 1 Selecting menu item:**
 - ▶ Turn controller; marking moves
 - ▶ Menu items shown in white can be selected by marking
- 2 Activating a menu item:**
 - ▶ Press controller
 - ▶ New menu items are displayed or function is carried out
- 3 Selecting a menu item: refer to 1**
- 4 Changing between fields:**
 - ▶ Briefly move controller left, right, forward or back
 - ▶ Release controller
 - ▶ Active field appears lighter
- 5 Adjusting settings:**
 - ▶ Turn controller
 - ▶ Graphic display, numerical value or text displays can be changed
 - ▶ Confirmation by changing field

Status information

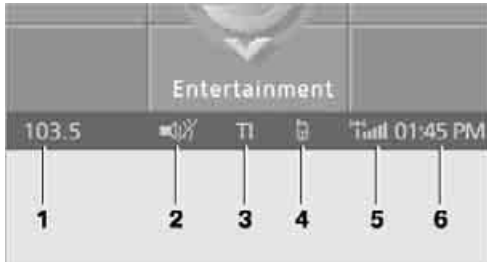

- 1 Display for:
 - ▷ Entertainment: Radio, CD
 - ▷ Telephone* in "Communication": Name of linked mobile phone, network search or no network
 - ▷ "BMW Assist"*: Existing voice connection with a service from BMW Assist
- 2 Entertainment sound output off
- 3 Station that transmits traffic information is received*:

"TI":
Traffic information for the navigation system can be received and transmission is switched on
- 4 Display for:
 - ▷ New entries present in "Missed calls"*
 - ▷ Roaming active
- 5 Telephony* is possible if the mobile phone is paired in the vehicle
 Mobile phone network reception strength, dependent on mobile phone
- 6 Time

Other displays:

When Check Control information appears or entries are made via the voice command system*, the status information is temporarily hidden.

Assistance window*



Additional information appears in the assistance window:

- ▷ the computer or the trip computer
- ▷ the arrow or map view with navigation system*
- ▷ the current position

Selecting display

1. Move the controller to the right to change to the assistance window and press the controller.

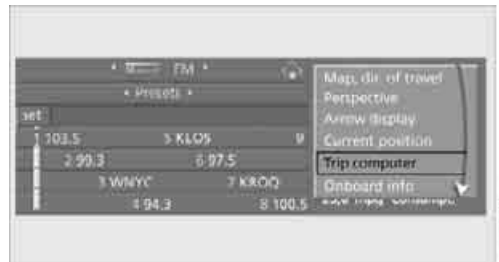

2. Select a menu item.
3. Press the controller.

Switching assistance window on/off

1. Move the controller to the right to change to the assistance window and press the controller.
2. Select "Assist. window off" and press the controller.



To switch on, change to the assistance window and press the controller.

Switching Control Display on/off

1. Press the **MENU** button.
This opens the start menu.
2. Press the controller to open the **i** menu.
3. Select "Display off" and press the controller.



To switch on, press the controller.

Voice command system*

The concept

The voice command system allows you to control operation of various vehicle systems without ever removing your hands from the steering wheel.

Individual menu items on the Control Display can be spoken as commands. This frees you of having to use the controller.

The voice command system transforms your spoken commands into control signals for the selected systems and provides support in the form of instructions or questions.

The voice command system includes a special microphone.

The microphone is located:

- ▷ Near the interior rearview mirror in the Coupe, refer to page 14
- ▷ On the steering column in the Convertible

Prerequisite

In order to enable identification of the commands to be spoken, use iDrive to set the language for the voice command system. Setting iDrive language, refer to page 79.

Symbols in Owner's Manual

- 🔊 ›...‹ Say the specified commands word for word.
- 🔊 ››...‹‹ Indicates the responses of the voice command system.

Voice commands

Activating voice command system

1. Press the  button.

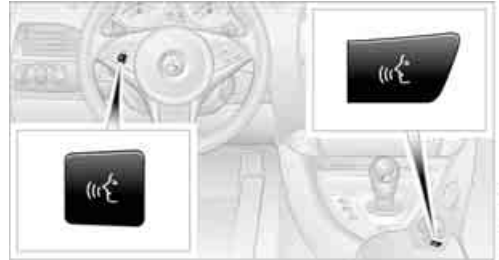

- 🔊 This symbol on the Control Display and an acoustic signal tell you that the voice command system can respond to commands.



2. Say the command.
The command is displayed on the Control Display.



- 🔊 This symbol is shown on the Control Display when you can input additional commands.

If no other commands are possible, then operate the equipment using iDrive.

Terminating or canceling voice command

Press the  button on the steering wheel or in the center console

or

 ›Cancel‹

Commands

Having possible commands read aloud

You can have the system read aloud the possible commands related to the selected menu item on the Control Display.

To have the system list the possible commands:

 ›Options‹

For example, if you have selected "CD", the system will read aloud the possible commands for operating the CD player and the CD changer*.

Opening help

 ›Help‹

Using alternative commands

There are often several commands for running a function, e.g.:

 ›Radio on‹ or ›Turn radio on‹

Running functions directly with short commands

With short commands you can run certain functions directly, regardless of which menu item is selected, refer to page 229.

Opening start menu

 ›Main menu‹

An example: selecting a track

1. Switch on Entertainment sound output if necessary.
2. Press the  button on the steering wheel or in the center console.

 3. ›Entertainment‹
The system says:
››Entertainment‹‹



 ›CD‹
The system says:
››CD on‹‹



4. Press the  button on the steering wheel or in the center console.

 5. Select a track, e.g.:
›Track 1‹
The system says:
››Track 1‹‹



Notes

 The mobile phone can also be operated with voice commands, refer to page 181. ◀

For voice commands, bear the following in mind:

- ▷ Say the commands and numbers smoothly and at normal volume, avoiding excessive emphasis and pauses. This also applies to spelling when entering the destination.
- ▷ Always issue commands in the language of the voice command system.
- ▷ When selecting a radio station, use the usual pronunciation of the station name.
- ▷ For entries in the voice-activated phone book, only use names in the language of the voice command system and no abbreviations.
- ▷ Keep the doors, windows and convertible top closed to prevent interference from ambient noise.
- ▷ Avoid background noises in the vehicle while speaking.





Controls

This chapter is intended to provide you with information for complete control of your vehicle. Its extensive array of features and accessories, both for driving and for your own safety, comfort and convenience, are described here.

Opening and closing

Keys/remote control



- 1 Remote control with integrated key
- 2 Spare key
- 3 Adapter for spare key, in glove compartment

Remote control with integrated key

Each remote control contains a battery which is automatically charged in the ignition lock while driving. Drive a longer distance with each remote control at least twice a year to keep the battery charged. For comfort access*, the remote control contains a replaceable battery, refer to page 38.

Depending on which remote control is detected by the vehicle during unlocking, different settings are called up and carried out in the vehicle, refer to Personal Profile, page 29.

Information on the required maintenance is also stored in the remote control, refer to Service data in remote control, page 207.

Integrated key



Press button 1 to unlock the key.

The integrated key fits the following locks:

- ▷ Hotel function, refer to page 33
- ▷ Driver's door, refer to page 32
- ▷ Luggage compartment lid, refer to page 34

New remote controls

To obtain additional or replace lost keys, new remote controls with an integrated key are available at your BMW center.

Spare key

Store the spare key in a safe place such as your wallet. This key is not intended for regular use.

The spare key and integrated key of the remote control fit the same locks.

Adapter for spare key

The adapter is required so that the vehicle can be started with the spare key or radio readiness can be switched on.



Remove the adapter from the holder in the glove compartment and slide the spare key into the adapter before use.

Personal Profile

The concept

You can set a number of functions of your BMW individually according to your preferences. Personal Profile ensures that most of these settings are stored for the remote control currently in use without you having to do anything. When the vehicle is unlocked, the corresponding remote control is detected and the settings stored for it are called up and carried out.

This means that you will always find your BMW set to your own personal settings even if another person with his/her own remote control and settings has used the vehicle since the last time you drove it. The individual settings are stored for a maximum of four remote controls.

Personal Profile settings

Details on the settings are provided on the specified pages.

- ▷ When unlocking with the remote control, either unlock only the driver's door or unlock the entire vehicle, refer to page [30](#)
- ▷ Locking the vehicle after a short time or after starting to drive, refer to page [33](#)
- ▷ Programming button on steering wheel, refer to page [53](#)
- ▷ Individual settings for MDrive, refer to page [54](#)

- ▷ Settings for the display on the Control Display:
 - ▷ Brightness of the Control Display, refer to page [78](#)
 - ▷ Units of measure for consumption, route/distances, temperature and pressure, refer to page [78](#)
 - ▷ Language on the Control Display, refer to page [79](#)
 - ▷ 12h/24h clock mode, refer to page [77](#)
 - ▷ Date format, refer to page [78](#)
- ▷ Lighting settings:
 - ▷ Pathway lighting, refer to page [95](#)
 - ▷ Daytime running lamps*, refer to page [96](#)
 - ▷ Triple turn signal activation, refer to page [64](#)
- ▷ Drivelogic driving program in the Sequential mode, refer to page [62](#)
- ▷ Showing optical warning for PDC Park Distance Control*, refer to page [81](#)
- ▷ Selection and brightness of the display for the Head-Up Display*, refer to page [92](#)
- ▷ Air distribution, temperature in the upper body region, and intensity for the automatic climate control, refer to page [100](#)
- ▷ Adjusting the voice instructions for the destination guidance of the navigation system*, refer to Starting navigation system on page [122](#)

The most recent settings for the following are also called up during unlocking:

- ▷ Driver's seat, exterior-mirror and steering-wheel position, refer to page [48](#)
- ▷ Audio sources, setting volume and tone, refer to page [149](#)
- ▷ Radio, displaying stored stations, refer to page [152](#)
- ▷ Telephone, setting volume, refer to page [176](#)

Central locking system

The concept

The central locking system is ready for operation whenever the driver's door is closed.

The system either locks or unlocks all of the following:

- ▷ Doors
- ▷ Compartment in the front center console
- ▷ Luggage compartment lid
- ▷ Fuel filler door

Operating from outside

- ▷ via the remote control
- ▷ via the door lock
- ▷ with comfort access* via the door handles

These actions operate the anti-theft system at the same time. It prevents the doors from being unlocked using the lock buttons or door handles. The interior lamps and the courtesy lamps are also switched on and off with the remote control. The alarm system is armed/disarmed at the same time.

You can find more detailed information on the alarm system on page 35.

Operating from inside

Via the central locking button, refer to page 32. The fuel filler door and the compartment in the front center console are not locked, refer to page 32.

In the event of a serious accident, the central locking system unlocks automatically. The hazard warning flashers and interior lamps are also switched on.

Opening and closing: from outside

Using remote control

 Persons or animals left unattended in a parked vehicle can lock the doors from the inside. Always take along the remote control when leaving the vehicle so that the vehicle can then be opened from the outside. ◀

Unlocking

Press the  button.

You can set how the vehicle is unlocked. The setting is stored for the remote control currently in use.

iDrive, for explanation of principle, refer to page 16.

1. Press the **MENU** button.
This opens the start menu.
2. Press the controller to open the **i** menu.
3. Select "Settings" and press the controller.
4. Select "Vehicle / Tires" and press the controller.
5. Change to upper field if necessary. Turn the controller until "Door locks" is selected and press the controller.

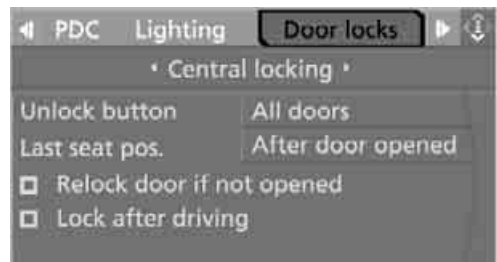

6. Select "Central locking" and press the controller.
7. Select "Unlock button" and press the controller.
8. Select a menu item:
 - ▷ "All doors"
Press the  button once to unlock the entire vehicle.

▷ "Driver's door only"*

Press the  button once to unlock only the driver's door and the fuel filler door. Press the button twice to unlock the entire vehicle.



9. Press the controller.

Comfort opening mode

Press the  button longer:

- ▷ Coupe: the windows are opened.
- ▷ Convertible: the windows and the convertible top are opened.

 Watch the convertible top during the opening process to be sure that no one is injured. Releasing the button stops the operation.◀

Locking doors

Press the  LOCK button.

 Do not lock the vehicle from the outside if persons are inside, as unlocking from the inside is not possible without special knowledge.◀

Switching on interior lamps

With vehicle locked:
Press the  LOCK button.
You can also use this function to locate your vehicle in parking garages etc.

Panic mode*

You can trigger the alarm system in case of danger:

Press the  button for at least 3 seconds.
To switch off alarm: press any button.

Opening luggage compartment lid

Press the  button for approx. 1 second.
The luggage compartment lid opens, regardless of whether it was previously locked or unlocked.

 A previously locked luggage compartment lid is also locked again after closing. Coupe: during opening, the luggage compartment lid pivots back and up. Make sure there is sufficient clearance.◀

Setting confirmation signals

You can vary or deactivate the confirmation signals for locking or unlocking.

1. Open the start menu.
2. Press the controller to open the **i** menu.
3. Select "Settings" and press the controller.
4. Select "Vehicle / Tires" and press the controller.
5. Change to upper field if necessary. Turn the controller until "Door locks" is selected and press the controller.
6. Select "Confirmation" and press the controller.



7. Select the desired signal.
8. Press the controller.
 The signal is activated.

Malfunction

The remote control may malfunction due to local radio waves. Should the remote control fail to operate due to interference of this kind, unlock and lock the vehicle via the door lock using a key.

If it is no longer possible to lock the vehicle using the remote control, then the battery is discharged. Use this remote control during an extended drive; this will recharge the battery, refer to page 28.

For US owners only

The transmitter and receiver units comply with part 15 of the FCC/Federal Communication Commission regulations. Operation is governed by the following:

FCC ID:
LX8766S
LX8766E
LX8CAS
LX8CAS2

Compliance statement:

This device complies with part 15 of the FCC Rules. Operation is subject to the following two conditions:

- ▶ This device may not cause harmful interference, and
- ▶ this device must accept any interference received, including interference that may cause undesired operation.

 Any unauthorized modifications or changes to these devices could void the user's authority to operate this equipment. ◀

Using door lock

 Do not lock the vehicle from the outside if persons are inside, as unlocking from the inside is not possible without special knowledge. ◀

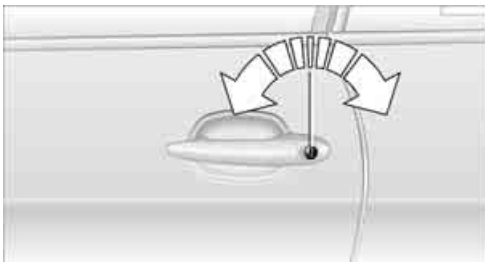

When unlocking

1. Turning the key once unlocks the driver's door and the fuel filler door.
2. A second turn of the key unlocks the passenger door and luggage compartment lid.

Comfort operation

You also have the option of operating the windows and the convertible top on the Convertible from the driver's door lock.

Turn and hold the key in the positions for unlocking or locking.

 Keep a close eye on the closing process and also on the opening process of the convertible top to be sure that no one is injured. Releasing the key stops the operation. ◀

Manual operation

In the event of an electrical malfunction, you can turn a key all the way to the right or left in the door lock to lock or unlock the driver's door.

Opening and closing: from inside



This button serves to unlock or lock doors and the luggage compartment lid, but does not activate the anti-theft system. The fuel filler door remains unlocked.

Automatic locking

iDrive, for explanation of principle, refer to page 16.

1. Press the **MENU** button.
This opens the start menu.
2. Press the controller to open the **i** menu.
3. Select "Settings" and press the controller.
4. Select "Vehicle / Tires" and press the controller.
5. Change to upper field if necessary. Turn the controller until "Door locks" is selected and press the controller.
6. Select "Central locking" and press the controller.



7. Select a menu item:
 - ▷ "Relock door if not opened"
The central locking system automatically locks the vehicle after a short time when no door has been opened.
 - ▷ "Lock after driving"
The central locking system automatically locks the vehicle as soon as you start to drive.
8. Press the controller.
 The setting is selected.

The setting is stored for the remote control currently in use.

Unlocking and opening doors

- ▷ Either unlock both doors at the same time with the button for the central locking system and then pull the door handle above the armrest or

- ▷ pull the door handle for each door twice: the first pull unlocks the door, and the second one opens it.

Locking doors

- ▷ Use the central locking button to lock both of the doors simultaneously, or
- ▷ press down the lock button of a door.
To prevent you from being locked out, the open driver's door cannot be locked using the lock button.

 Persons or animals left unattended in a parked vehicle can lock the doors from the inside. Always take along the remote control when leaving the vehicle so that the vehicle can then be opened from the outside. ◀

Hotel function

The hotel function locks the compartment in the front center console and the luggage compartment lid separately and disconnects them from the central locking system. If you hand over the remote control without the integrated key, refer to page 28, e.g. at a hotel, then this prevents access to the luggage compartment and to the compartment in the front center console.



Turn the key to the right, refer to illustration, until the key slot points in the direction of travel and then remove:

The hotel function is activated after subsequent locking or unlocking of the vehicle. The system locks the luggage compartment lid and the compartment in the front center console and disconnects them from the central locking system.

Unlocking manually

In order to manually unlock the compartment in the front center console in the event of an electrical malfunction, turn the key all the way to the right until it reaches the stop.

▶ If unlocking was manual, return the lock to the home position, i.e. all the way back to the left, before reactivating the hotel function. ◀

Doors

Automatic soft closing*

To close the doors, merely press it closed gently. The closing process will then be carried out automatically.

⚠ Make sure that the closing path of the doors is clear; otherwise injuries may result. ◀

Luggage compartment lid

▶ During opening, the luggage compartment lid pivots back and up. Make sure there is sufficient clearance. ◀

Opening from inside

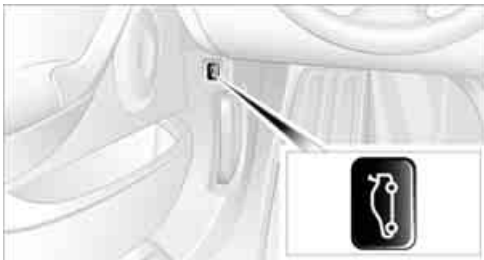

Press the button:

The luggage compartment lid opens, provided that it is not locked or the hotel function is not activated, refer to the above section.

Opening from outside

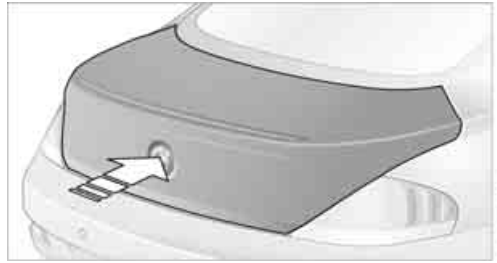

Press the upper half of the BMW emblem or press the  button on the remote control for approx. 1 second: the luggage compartment lid opens.

▶ Convertible: if the convertible top is not completely open or closed, then the luggage compartment lid cannot be opened, refer to page 41. ◀

Unlocking manually



The luggage compartment lid lock is located under the BMW emblem. All keys, refer to page 28, fit the luggage compartment lid lock.

Turn the key toward the right up to the stop: the luggage compartment lid opens.

▶ If you use the lock to open the luggage compartment lid while the alarm system is armed, the alarm will be triggered. To prevent this, you should deactivate the alarm beforehand.

If the alarm has been triggered accidentally, switch off the alarm, refer to page 36. ◀

Closing

 Make sure that the closing path of the luggage compartment lid is clear; otherwise, injuries may result. ◀



The handle recesses on the interior trim of the luggage compartment lid make it easier to pull down.

Emergency release



Pull the lever in the luggage compartment. The luggage compartment lid is unlocked.

Luggage compartment

There are four lashing eyes on the inner corners of the luggage compartment for securing luggage nets* or securing straps to fix luggage in position.

Also refer to Securing cargo, page 118.

Convertible: increasing luggage compartment capacity

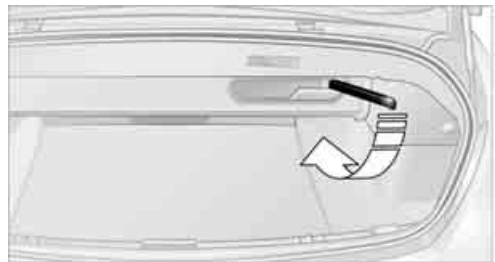

With the convertible top closed, you can increase the luggage compartment capacity: To do so, unfold the handle and press it downward in the direction of travel, refer to arrow. This moves the convertible top compartment floor into the raised position.

Before opening the convertible top, carry out this procedure in reverse order.

 The convertible top cannot be opened if the convertible top compartment floor is in the raised position. ◀

Alarm system

The concept

The vehicle alarm system responds:

- ▷ To the opening of a door, the hood, or the luggage compartment lid
- ▷ To movements in the vehicle interior: interior motion sensor, refer to page 36
- ▷ To changes in the vehicle's tilt if someone attempts to steal the wheels or tow the vehicle
- ▷ To interruptions in battery voltage

Unauthorized operations are briefly signaled by the alarm system:

- ▷ by triggering an acoustic alarm
- ▷ by switching on the hazard warning flashers
- ▷ by flashing the high beams

Arming and disarming alarm system

When you lock or unlock the vehicle, either with the remote control or at the door lock, the alarm system is armed or disarmed at the same time.

You can open the luggage compartment lid, even with the system armed, by using the  button of the remote control, refer to page 31. When the luggage compartment lid is closed, it is once again locked and monitored.

Switching off alarm

- ▷ Unlock the vehicle using the remote control, refer to page 30, or
- ▷ insert the remote control all the way into the ignition lock.

Indicator lamp displays



- ▷ The indicator lamp below the interior rearview mirror flashes continuously: the system is armed.
- ▷ The indicator lamp flashes after locking: the doors, hood or luggage compartment lid are not properly closed. Even if you do not close the alerted area, the system begins to monitor the remaining areas, and the indicator lamp flashes continuously after approx. 10 seconds. However, the interior motion sensor is not activated.
- ▷ After the vehicle is unlocked, the indicator lamp goes out: no manipulation or attempted intrusions have been detected in the period since the system was armed.
- ▷ The indicator lamp flashes after unlocking until the remote control is inserted into the ignition lock, however for a maximum of approx. 5 minutes: an attempted entry has

been detected in the period since the system was armed.

Tilt alarm sensor

Monitors the inclination of the vehicle. The alarm system reacts, for example, if someone attempts to steal the wheels or tow the vehicle.

Interior motion sensor

Coupe:

The condition for proper operation of the interior motion sensor is closed windows.

Convertible:

Monitors the interior up to the height of the seat cushions. This means that the alarm system, including the interior motion sensor, is armed even if the convertible top is open. Falling objects, e.g. leaves, can trigger false alarms, refer to Avoiding unintentional alarms.

Avoiding unintentional alarms

The tilt alarm sensor and interior motion sensor may be switched off at the same time.

This prevents unintentional alarms, e.g. in the following situations:

- ▷ In two-level garages
- ▷ When transporting on car-carrying trains, by sea or on a trailer
- ▷ When animals are to remain in the vehicle

Switching off tilt alarm sensor and interior motion sensor

Press the  LOCK button on the remote control again as soon as the vehicle is locked.

The indicator lamp lights up briefly and then flashes continuously. The tilt alarm sensor and the interior motion sensor are switched off until the vehicle is unlocked and locked again.

Comfort access*

Comfort access enables you to access your vehicle without having to hold the remote control in your hand. It is sufficient to carry the remote control with you, e.g. in your jacket pocket. The vehicle automatically detects the related remote control in the immediate vicinity or in the interior.

Comfort access supports the following functions:

- ▶ Unlocking/locking vehicle
- ▶ Comfort closing with Coupe
- ▶ Opening luggage compartment lid separately
- ▶ Starting engine

Functional requirement

- ▶ The vehicle or the luggage compartment lid can only be locked if the vehicle detects that the remote control you are carrying is outside the vehicle.
- ▶ The next unlocking and locking cycle is not possible until after approx. 2 seconds.
- ▶ The engine can only be started if the vehicle detects that the remote control is located in the vehicle.

Comparison with ordinary remote control

You can control the functions mentioned previously with the comfort access or by pressing the buttons on the remote control. Before doing so, please familiarize yourself with the information on opening and closing, starting on page 28.

The special features when using comfort access are described below.

 Should a short delay occur when opening or closing the windows or the convertible top, the system is checking whether a remote control is located in the vehicle. Please repeat opening or closing if necessary. ◀

Unlocking

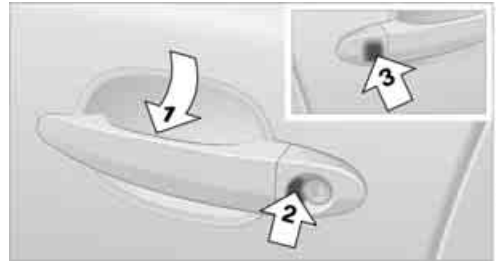

Completely grasp a door handle, arrow 1. This corresponds to pressing the  button.

Locking doors

- ▶ For the driver's door, touch the area highlighted in the picture, arrow 2, with your finger for approx. 1 second.
- ▶ For the passenger's door, touch the area highlighted in the picture, arrow 3, with your finger for approx. 1 second.

This corresponds to pressing the  LOCK button.

 Please make sure that the ignition and all electronic systems/consumers are switched off before locking to save the battery. ◀

Coupe: comfort closing

Hold a finger or the back of the hand on the surface, arrow 2 or 3.

The windows are closed.

 Watch during the closing process to be sure that no one is injured. Removing the hand from the door handle stops the closing process immediately. ◀

Convertible: window and convertible top operation

From radio readiness switched on, the windows can be opened and closed, and with the vehicle stopped the convertible top, when a remote control is located in the interior of the vehicle.

Opening luggage compartment lid separately

Press the upper half of the BMW emblem. This corresponds to pressing the  button.

 If a remote control accidentally left in the luggage compartment is detected inside the locked vehicle after the luggage compartment lid has been closed, then the luggage compartment lid opens again. The hazard warning flashers flash and a signal* sounds. ◀

Switching on radio readiness

By briefly pressing the Start/Stop button, you switch on the radio readiness, refer to page 58.

 When doing so, do not depress the brake or clutch pedal, otherwise the engine will start immediately. ◀

Starting engine

You can start the engine or switch on the ignition if a remote control is located in the interior of the vehicle. It need not be inserted in the ignition lock, refer to page 58.

If you take the remote control with you when leaving the vehicle with the engine running, a warning lamp lights up. In addition, a message appears on the Control Display. As long as no remote control is detected in the vehicle, it is only possible to restart the engine within approx. 10 seconds after it is switched off.

Malfunction

The comfort access function may malfunction due to local radio waves. If this occurs, then open or close the vehicle with the buttons on the remote control or with a key. To start the engine after this, insert the remote control in the ignition lock.

Replacing battery

The remote control for comfort access contains a battery which must be replaced occasionally.

1. Remove integrated key from remote control, refer to page 28.



2. Remove cover.
3. Insert new battery with positive side facing upward.
4. Press cover closed.

 Return used battery to a recycling collection point or to your BMW center. ◀

Windows

 To prevent injuries, exercise care when closing the windows and keep them in your field of vision until they are shut. Always take along the remote control when you leave the vehicle; otherwise, children could, for example, operate the windows and injure themselves. ◀

Coupe: opening, closing



- ▷ Press switch to resistance point: The window continues to open for as long as you hold down the switch.

- ▶ Press the switch beyond the resistance point:
The window opens automatically. Pressing the switch again stops the opening movement.

You can close the windows in the same manner by pulling the switch.

Convertible: opening, closing

For information on window operation with comfort access, also refer to page 37.

- ⚠ To close the side windows while the vehicle is being driven, always close the rear windows first or all four windows simultaneously; otherwise, the windows cannot close tightly at higher speeds. ◀

Individually



- ▶ Press switch to resistance point:
The window continues to open for as long as you hold down the switch.
- ▶ Press the switch beyond the resistance point:
The window opens automatically. Pressing the switch again stops the opening movement.

You can close the windows in the same manner by pulling the switch. The rear windows cannot be closed automatically.

Together



1. Briefly press button 1:
The LEDs in button 1 and switch 2 light up for approx. 10 seconds.
2. Press switch 2:
 - ▶ Down to the resistance point:
All windows, including the rear window, continue to open as long as you press the switch.
You can close the windows in the same manner by pulling the switch.
 - ▶ Press the switch beyond the resistance point:
All windows open automatically. Pressing the switch again stops the opening movement.

Briefly press button 1 again to deactivate the function. The LEDs go out.

Rear window



1. Briefly press button 1:
The LEDs in button 1 and switch 2 light up for approx. 10 seconds.
2. Press switch 2:
 - ▶ Down to the resistance point:
The rear window continues to open for as long as you hold down the switch.

You can close the rear window in the same manner by pulling the switch.

- ▷ Press the switch beyond the resistance point:
The rear window opens automatically. Pressing the switch again stops the opening movement.

Briefly press button **1** again to deactivate the function. The LEDs go out.

 The rear window opens and closes automatically when you open or close the convertible top. ◀

For information on using the comfort operation mode at the door lock or with the remote control, refer to page [31](#) or [32](#).

Coupe: for information on comfort closing with comfort access, refer to page [37](#).

After switching off ignition

You can still operate the windows with the remote control removed or the ignition switched off for approx. 1 minute, as long as neither of the doors has been opened.

Pinch protection system

If the closing force exceeds a specific value as a window closes, the closing action is interrupted and the window reopens slightly.

 Despite the pinch protection system, inspect the window's travel path prior to closing it, as the safety system might fail to detect certain kinds of obstructions, such as thin objects, and the window would continue closing.

Do not install any accessories in the range of movement of the windows, otherwise the pinch protection system will be impaired.

Convertible: the rear side windows and rear window are not equipped with a pinch protection system. Therefore, watch the rear side windows and the rear window during closing, otherwise injuries can occur. ◀

Closing without pinch protection system

In case of danger from outside or if, for example, ice on the window prevents normal closing, proceed as follows:

1. Pull the switch beyond the resistance point and hold. The pinch protection system is limited and the window opens slightly if the closing force exceeds a certain value.
2. Pull the switch beyond the resistance point and hold again within approx. 4 seconds. The window closes without the pinch protection system.

Convertible: top

The fully automatic convertible top combines secure weather protection with simple and convenient operation.

Here are a few tips for getting the maximum pleasure from your Convertible:

- ▷ It is advisable to close the convertible top when the vehicle is parked. The closed convertible top not only protects the passenger compartment from unforeseen weather damage, it also provides a certain amount of protection from theft. Nonetheless, even if the convertible top is closed, only keep valuables in the locked luggage compartment.
- ▷ Do not attach luggage rack systems to the convertible top.

 In order to avoid damage, do not move the convertible top at temperatures below +14 °F / -10 °C.

Do not leave the convertible top in its storage compartment for longer than one day when wet; otherwise, damage from moisture can occur. Do not place any objects on the convertible top; otherwise, if the top were to be operated, these objects could fall off and lead to damage or injury.

Never move the convertible top when the roll-over protection system is raised.

Driving without having completed the opening or closing action can lead to damage or injury.

Do not place hands in the top mechanism during the opening and closing action. Keep children away from the travel path of the convertible top.

For safety reasons, do not move the convertible top unless the vehicle is stationary. ◀

▶ If you have initiated top movement with the vehicle at a stop and then start to drive, e.g. at a traffic light, you can continue the initiated operation up to a speed of 20 mph/30 km/h:

To do so, press and hold the corresponding button. ◀

▶ Partial vacuums that occur at higher speeds in the passenger compartment can make the convertible top flap. Use the automatic climate control to increase the air volume so that a partial vacuum in the vehicle does not occur. ◀

Prior to opening and closing

- ▶ Read the safety precautions above carefully and comply with them fully.
- ▶ Ensure that the convertible top compartment floor in the luggage compartment is folded down, refer to page 35, as otherwise the convertible top cannot be opened.
- ▶ Make sure that the luggage compartment lid is closed.

Opening and closing

For information on top operation with comfort access, also refer to page 37.

From radio readiness, refer to page 58, with the vehicle stationary:

▶ To avoid putting excessive strain on the battery, only move the convertible top when the engine is running if possible. Before closing the convertible top, remove foreign objects from the windshield frame, as these might inhibit closing of the convertible top. ◀



- 1 Closing
- 2 LED
- 3 Opening

▶ When the button for operating the convertible top is pressed, the side windows move downward slightly and the rear window is lowered completely.

If you hold down the button after the LED 2 goes out, then the windows travel upward again.

If the convertible top is not completely open or closed, then the luggage compartment lid cannot be opened. ◀

LED

In the following situations, in addition to the LED, a message is displayed on the Control Display and an acoustic signal may sound:

- ▶ During convertible top operation, the LED lights up green. It goes out as soon as the opening or closing action is finished.
- ▶ If the LED flashes red when you release the button, the opening or closing action has not yet finished.
- ▶ If the LED lights up red when the button is pressed, either the convertible top compartment floor in the luggage compartment is in the raised position or a malfunction has occurred. The convertible top cannot be moved.

Interruption

The automatic sequence of movements is interrupted if the button for top operation is released. The sequence can be continued in the desired direction by pressing the appropriate button.

If the opening or closing action is interrupted for a longer period, the convertible top remains in that position for approx. 15 minutes before it slowly moves to a stable position.

⚠ A convertible top which is not completely opened or closed presents a danger. Do not interrupt and continue the closing action several times in succession; otherwise, the top mechanism can be damaged. ◀

▶ If the convertible top is not completely open or closed, then the luggage compartment lid cannot be opened. ◀

Comfort operation with remote control and via door lock

Refer to pages 31 and 32.

Closing manually

⚠ Only close the convertible top manually if absolutely necessary; never open it manually. The convertible top compartment lid cannot be locked in the event of an electrical malfunction and would open while the vehicle is being driven.

Improper handling can lead to damage. ◀

Before closing

1. Open luggage compartment lid.
2. Take the Allen wrench and the screwdriver from the onboard tool kit, refer to page 209.
3. Pry out the two buttons in the luggage compartment with the screwdriver and then pull firmly. This unlocks the convertible top compartment lid.

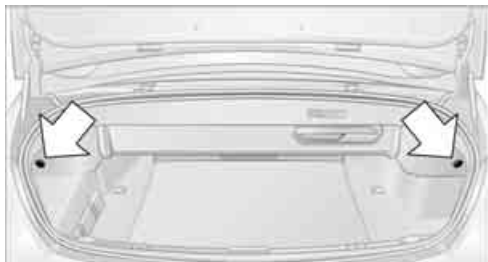

4. Close luggage compartment lid.

▶ During manual convertible top operation, the luggage compartment lid cannot be opened. ◀

5. Completely open the side windows and the rear window.

If the rear window cannot be opened using the switch, it must be lowered manually.

Opening rear window manually

1. Pry out the cover between the rear head restraints. To do so, place the screwdriver as close as possible to the locking elements, as shown in the illustration.



2. Insert the Allen wrench as far as possible into the opening and turn firmly in the direction indicated by the arrow until the rear window is completely open.

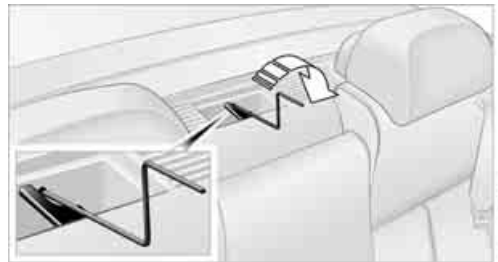

Closing

⚠ Perform the following work steps with the assistance of a second person and with the doors open, otherwise injury and damage to the convertible top can occur. ◀

1. Push the cover **1** on the left and right of the side panel forward. Reach into the resulting openings and raise the convertible top compartment lid **2** as far as it will go.

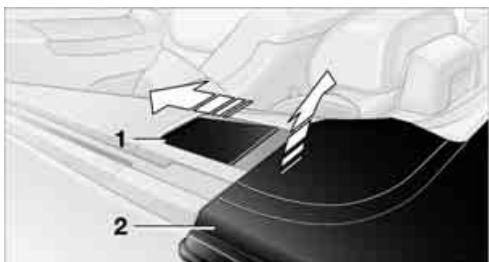

2. Grasp the top with both hands at the left and right side frame, arrow **3**.



Only lift out the top by the side frame, otherwise the top may be damaged. ◀



3. Together with the other person, pull the two sides of the convertible top out simultaneously and pivot forward. When doing so, keep the convertible top compartment lid open, arrow **4**, e.g. with your shoulder.



Do not carry out the next operation, raising top ends, until the top has been swung forward, otherwise damage can occur. ◀

4. Raise the two convertible top ends as far as possible, arrow **5**, and close the convertible top compartment lid, arrow **6**.

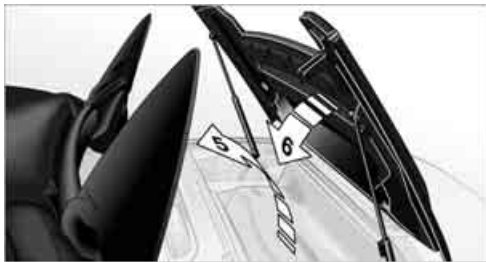

5. Fold the top ends down onto the convertible top compartment lid.
6. From the interior, take out the cover in the center of the front top frame; use a screwdriver if necessary.
7. Insert the Allen wrench into the opening provided.



8. From the outside, both persons pull the front frame of the convertible top downward, as simultaneously as possible on the two sides.
9. Turn the Allen wrench in the direction of the arrow until the front convertible top frame is locked to the windshield frame. The rear convertible top ends are automatically pressed onto the convertible top compartment lid and close tightly with tension.
10. If necessary, close the rear window again manually in the same way as above.

Wind deflector*

The wind deflector keeps the air movement in the passenger compartment to a minimum when the convertible top is open, thus enabling pleasant driving even at higher speeds.

The wind deflector is stowed in a protective sleeve in the luggage compartment. Short instructions for use are also provided on the protective sleeve.

Before installing

1. Remove the wind deflector from the protective sleeve and fold it open, refer to arrows 1.

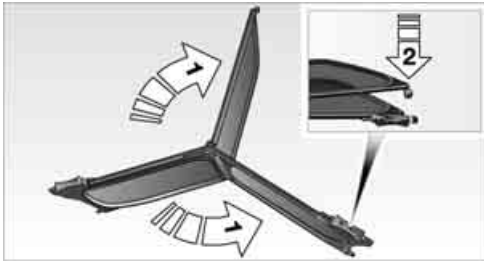

2. Press the upper and lower section together until the locking device engages, refer to arrow 2.
3. Push the securing pin 3 out until it engages.

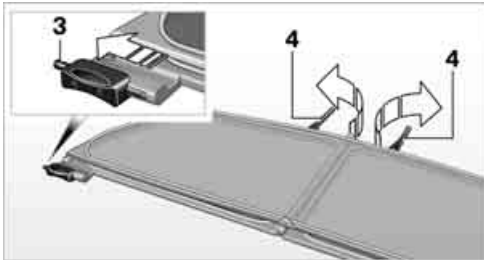

4. Unfold the rear mounts 4.

Installing

1. Insert the securing pin 1 of the wind deflector into the appropriate opening on the right side of the vehicle.

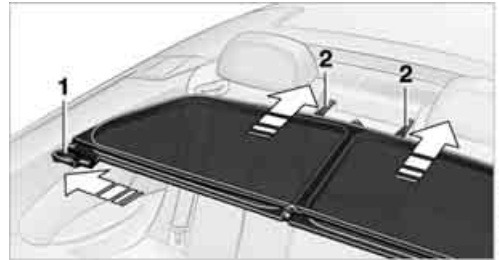

2. Guide the rear mounts 2 into the receptacles provided.
3. Push the securing pin 3 on the left side into the appropriate opening until it snaps into place.



4. Fold up the upper half 4 of the wind deflector.

! With wind deflector fitted: do not incline the front seat backrests too far backward if the seat is to be moved back to the end position. Otherwise, the wind deflector will be damaged. ◀

Removing

The same as installing, but in reverse order.

Folding up

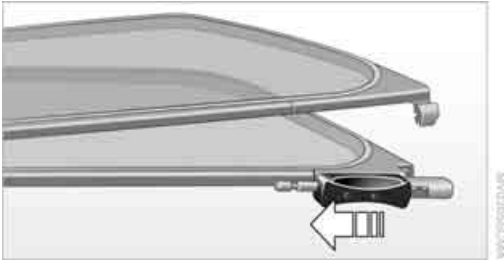

1. Push the handle of the securing pin on the wind deflector on the left side of the vehicle all the way back and release the locking mechanism.
2. Fold in the upper and lower section.

Adjusting

Sitting safely

The ideal sitting position can make a vital contribution to relaxed, fatigue-free driving. In the interaction with the safety belts, the head restraints and the airbags, the seat position plays an important role in an accident. To ensure that the safety systems operate with optimal efficiency, we strongly urge you to follow the instructions contained in the following section.

For additional information on Transporting children safely, refer to page 56.

Airbags

 Always maintain an adequate distance between yourself and the airbags. Always hold the steering wheel by its rim with hands at the 9 o'clock and 3 o'clock positions to minimize the risk of injuries to your hands and arms in the event of airbag deployment.

No one and nothing is to come between the airbags and the seat occupant.

Do not use the cover of the front airbag on the front passenger side as a storage area. Make sure that the front passenger is sitting correctly and does not rest feet or legs on the instrument panel, otherwise leg injuries can occur if the knee and front airbags are triggered.

Make sure that occupants do not rest their head on the side or head airbags; otherwise, injuries can occur if the airbags are triggered. ◀

Even if you adhere to all the instructions, injuries resulting from contact with airbags cannot be fully excluded, depending on the circumstances. The ignition and inflation noise may provoke a mild hearing loss in extremely sensitive individuals. This effect is usually only temporary.

For airbag locations and additional information on airbags, refer to page 89.

Head restraints

A correctly adjusted head restraint reduces the risk of injury to cervical vertebrae in an accident.

 Adjust the head restraint so that its center is approx. at ear level. Otherwise, there is increased danger of injury in the event of an accident. ◀

Head restraints, refer to page 49.

Safety belt

Before every drive, make sure that safety belts are being worn at all of the occupied seats. Airbags complement the safety belt as an additional safety device, but they do not represent a substitute.

Your vehicle has four seats that are each equipped with a safety belt.

 Never allow more than one person to wear a single safety belt. Never allow infants or small children to ride in a passenger's lap. Make sure that the belt lies low around the hips in the lap area and does not press on the abdomen. The safety belt may not lie across the neck, rub on sharp edges, be routed over solid or breakable objects or be pinched. Wear the safety belt without twisting, snugly across the lap and shoulders, as close to the body as possible. Otherwise, the belt can slip over the hips in the lap area in a frontal impact and injure the abdomen. Avoid wearing clothing that prevents the belt from fitting properly and pull the shoulder belt upward periodically to readjust the tension across your lap in order to avoid a reduction in the restraining effect of the safety belt. ◀

Safety belts refer to page 51.

Seats

Note before adjusting

⚠ Never attempt to adjust your seat while operating the vehicle. The seat could respond with unexpected movement and the ensuing loss of vehicle control could lead to an accident.

On the front passenger side as well, do not tilt the backrest too far toward the rear. Failure to observe this precaution can prevent the belt from providing effective protection against injury, as the passenger could slide under the belt in an accident. ◀

Also follow the instructions regarding damage to the safety belt on page 51.

⚠ Convertible: with the wind deflector fitted, do not incline the front seat backrests too far backward if the seat is to be moved back to the end position. Otherwise, the wind deflector will be damaged. ◀

Adjusting seat

⚠ To ensure that the safety systems continue to provide optimized protection, please follow the adjustment instructions on page 46. ◀



- 1 Inclination
- 2 Longitudinal direction
- 3 Height
- 4 Backrest
- 5 Convertible: head restraints, refer to page 50



- 6 Coupe: backrest width
- 7 Lumbar support

Lumbar support

You can also adjust the contours of the backrest to obtain additional support in the lumbar region.

The upper hips and spinal column receive supplementary support to help you maintain a relaxed, upright sitting position.

- ▷ Increase or decrease curvature: Press front or rear of switch.
- ▷ Move curvature up or down: Press top or bottom of switch.

Thigh support

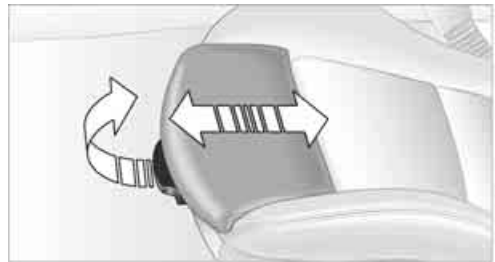

You can also adjust the thigh support manually: Pull the lever and adjust the thigh support in the longitudinal direction.

Seat, mirror and steering wheel memory

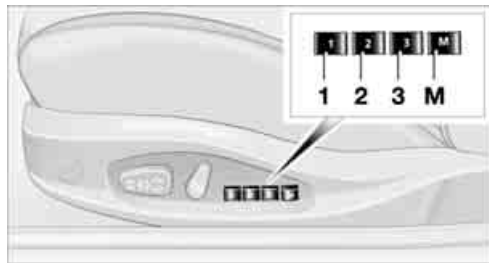

You can store and select three different adjustment settings for the driver's seat, exterior mirrors and steering wheel.

The adjustments of the lumbar support and the backrest width are not stored in the memory.

Storing

1. Switch on radio readiness or ignition, refer to page 58.
2. Adjust the desired seat, exterior mirror and steering-wheel positions.
3. Press the **M** button:
The LED in the button lights up.
4. Press the desired memory button **1**, **2** or **3**:
The LED goes out.

Requesting

 Do not request a position from the memory while the vehicle is moving. There is a risk of accident from unexpected movement of the seat or steering wheel. ◀

Comfort mode

1. Open the driver's door after unlocking or switch on radio readiness, refer to page 58.
2. Briefly press the desired memory button **1**, **2** or **3**.

The system cancels the adjustment procedure when you briefly press one of the seat adjustment switches or one of the memory buttons.

The adjusting procedure for the steering wheel is interrupted if you briefly press the switch for the steering wheel adjustment in any direction, refer to page 53.

Safety feature

1. Close the driver's door and switch ignition on or off, refer to page 58.
2. Press the desired memory button **1**, **2** or **3** and maintain pressure until the adjustment process has been completed.

If the **M** button was pressed inadvertently: press the button again; the LED goes out.

Activating with remote control

The last positions of the driver's seat, external rearview mirrors, and steering wheel are stored for the remote key currently in use.

You can choose when the position is requested:

- ▷ Request when unlocking vehicle
- ▷ Request when opening driver's door

 When using this feature, always make sure that the footwell behind the driver's seat is empty and unobstructed. If you fail to do so, any persons or objects behind the seat could be injured or damaged by a rearward movement of the seat. ◀

The system cancels the adjustment procedure when you briefly press one of the seat adjustment switches or one of the memory buttons.

iDrive, for explanation of principle, refer to page 16.

1. Open the start menu.
2. Press the controller to open the **i** menu.
3. Select "Settings" and press the controller.
4. Select "Vehicle / Tires" and press the controller.
5. Change to upper field if necessary. Turn the controller until "Door locks" is selected and press the controller.

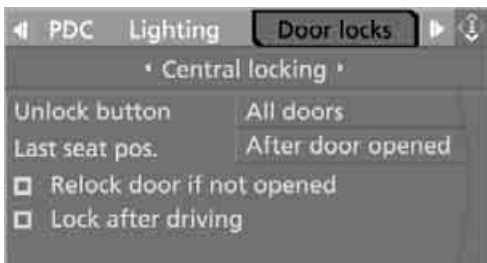

6. Select "Central locking" and press the controller.
7. Select "Last seat pos." and press the controller.
8. Select "After unlocking" or "After door opened".



9. Press the controller.

To cancel the request:
Select "Deactivated" and press the controller.

Front head restraints

A correctly adjusted head restraint reduces the risk of injury to cervical vertebrae in an accident.

⚠ Adjust the head restraint so that its center is approx. at ear level. Otherwise, there is increased danger of injury in the event of an accident. Only remove the head restraints if no one will be sitting on the seat in question. Reinstall the head restraints before transporting passengers, as otherwise the head restraint cannot provide its protective function. ◀

Coupe

Adjusting height



- ▷ To raise: pull the head restraint upward.
- ▷ To lower: slide the head restraint downward.

▷ To reach the lowest position, press the button, refer to arrow 1. ◀

Adjusting tilt angle

Swivel the head restraints.

Removing

1. Pull the head restraint upward to the stop.
2. Press the button, arrow 1, and remove the head restraint.

▷ Only remove the head restraints if no one will be sitting on the seat in question. Reinstall head restraint before passengers use the respective seat. ◀

Installing

Insert head restraint into the sockets and adjust.

Convertible

Adjusting height



- ▷ To raise: move the switch upward.
- ▷ To lower: move the switch downward.

Adjusting tilt angle



Swivel the head restraints.

Entering rear

⚠ Before starting to drive, fold backrests back, otherwise there is the danger of accident due to an unexpected movement of the seat. ◀

Coupe: releasing backrest



Pull the lever upward and fold the backrest forward.

The lever is designed so that the safety belt can be hooked onto it. This enables you to fasten the safety belt more conveniently.

Convertible: releasing backrest

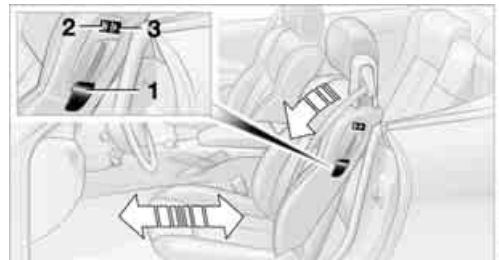

The belt system integrated in the seat makes it easier to get in back.

1. Pull lever **1** up and fold the backrest forward.
2. Press and hold button **2** until the seat has moved into the desired position.
3. After passengers have entered the rear, fold the backrest back and lock it in place.
4. Press and hold button **3** until the seat has moved back into its previous position. If you release button **3** before this, the seat stops in its current position.

▷ You can lock the backrest in place when it is folded forward. This is useful, for example, when you get into the vehicle while it is parked on a hill. Press the backrest until it audibly locks into place. To fold it back, you do not need to use lever **1** to release it. ◀



Lock backrest warning lamp:
Lights up when the backrest is not
locked. At the same time, a message is
shown on the Control Display.

Safety belts



To ensure that the safety systems continue to provide optimized protection, please follow the adjustment instructions on page 46. ◀

Before every drive, make sure that safety belts are being worn at all of the occupied seats. Airbags complement the safety belt as an additional safety device, but they do not represent a substitute.

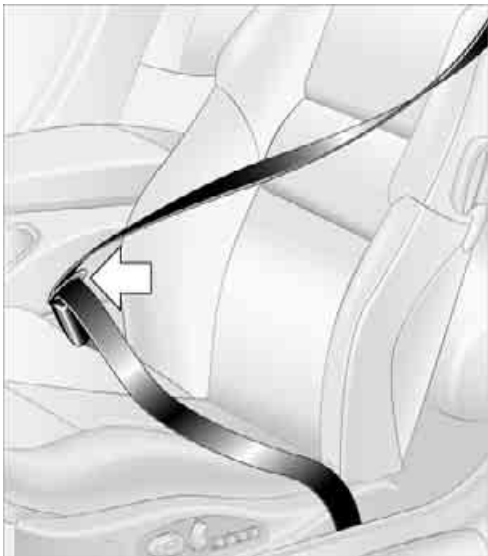

Fastening

Make sure you hear the latch plate engage in the belt buckle.

Releasing

1. Hold the belt firmly.
2. Press the red button in the belt buckle.
3. Guide the belt into its reel.

The shoulder strap's anchorage point will be in the correct position for adults of every build if the seat is correctly adjusted, refer to page 47.

Safety belt reminder for driver's seat and passenger seat*



The indicator lamp lights up and a signal sounds. At the same time, an additional message appears on the Control Display. Please check whether safety belts are being worn correctly.

The safety belt reminder is operative at speeds above approx. 5 mph/8 km/h. It can also be activated if objects are placed on the passenger seat.

Damage to safety belts



In the event of loads caused by accidents or other damage: replace the belt system including the safety belt tensioners and any child restraint systems, and have the belt anchor points checked. Have this work carried out only by a BMW center or a workshop that works according to BMW repair procedures with appropriately trained personnel. Otherwise, correct operation of this safety equipment is not guaranteed. ◀

Heated seats



The temperature setting advances one step in its control sequence each time you press the button. The maximum temperature is supplied when three LEDs are lit.

To switch off:
Press the button longer.

Mirrors

Exterior mirrors

 The mirror on the passenger's side is more curved than the driver's mirror. Objects reflected in the mirror are closer than they appear. Do not estimate the distance of following traffic based on what you see in the mirrors; otherwise, there is an increased accident risk. ◀

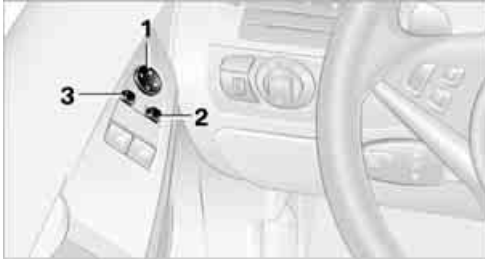

- 1 Adjusting
- 2 Switching to the other mirror or to the automatic curb monitor
- 3 Folding mirrors in and out*

Storing the mirror positions, refer to Seat, mirror and steering wheel memory on page 48.

Adjusting manually

You can also adjust the mirrors manually by pressing against the outer edges of their mirror glass.

Folding exterior mirrors in and out

Pressing button **3** allows you to fold mirrors in and out up to a speed of approx. 20 mph/ 30 km/h. This is advantageous, for example, in car washes, narrow streets or for bringing mirrors that have been manually folded-in back into the correct position. Mirrors that were folded in are folded out automatically at a speed of approx. 25 mph/40 km/h.

Automatic heating

Below a certain outdoor temperature, both exterior mirrors are automatically heated when the motor is running or the ignition is switched on.

Tilting down passenger-side mirror – automatic curb monitor

Activating

1. Slide switch into the driver's side mirror position, arrow **1**.



2. Engage reverse gear or selector lever position R.
The mirror glass tilts downward somewhat on the passenger's side. This allows the driver to see the area immediately adjacent to the vehicle – such as a curb – when parking, etc.

Deactivating

Slide switch into the passenger side mirror position, arrow **2**.

Interior and exterior mirrors, automatic dimming feature

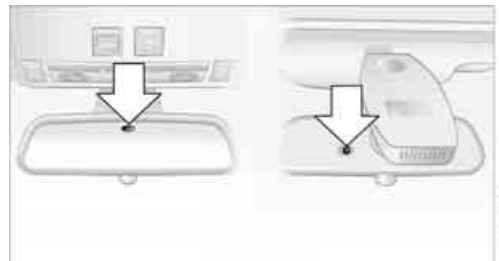

This feature is controlled by two photocells in the inside rearview mirror. One is integrated within the mirror's lens, while the other is located at an offset position on the rear of the mirror housing.

For trouble-free operation, keep the photocells clean and do not cover the area between the interior rearview mirror and the windshield.

Also do not attach stickers to the windshield in front of the mirror.

Steering wheel

Adjusting

⚠ Do not adjust the steering wheel while the vehicle is moving. There is a risk of accident as the result of unexpected movement. ◀

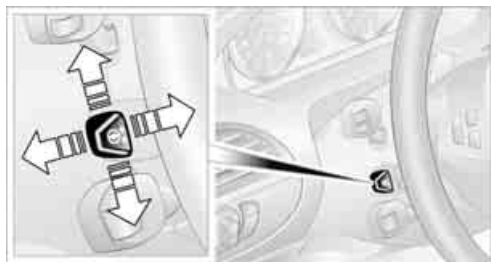

The steering wheel can be adjusted in four directions.

Storing the steering-wheel position, refer to Seat, mirror and steering wheel memory, page 48.

Easy entry/exit

To make it easier to enter and exit the vehicle, the steering wheel temporarily moves into the uppermost position.

Programmable button on steering wheel



You can program the button individually.

The setting is stored for the remote control currently in use.

iDrive, for explanation of principle, refer to page 16.

1. Press the **MENU** button.
This opens the start menu.
2. Press the controller to open the **i** menu.



3. Turn the controller until "Settings" is selected and press the controller.
4. Turn the controller until "Steering wheel button" is selected and press the controller.

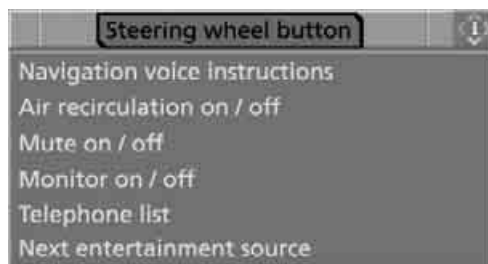

A list of different functions appears:

- ▷ "Navigation voice instructions"
Voice instructions of the navigation system*
- ▷ "Air recirculation on / off"
Permanently shutting off outside air, refer to AUC Automatic recirculated-air control on page 102
- ▷ "Mute on / off"
Mutes the audio sources
- ▷ "Monitor on / off"
Switches the Control Display on/off
- ▷ "Telephone list"*
Display/hide phone book or last list of stored phone numbers displayed
- ▷ "Next entertainment source"
Changes audio source

5. Select the desired function unit and press the controller.

Operating function

Press the button on the steering wheel.

If you have programmed "Navigation voice instructions" for the button:

- ▷ To switch voice instructions on/off: Press the button longer.
- ▷ To repeat the last voice instruction: Press the button.

MDrive

With MDrive you can configure several individual settings for your vehicle on the Control Display and activate them simultaneously with the  button on the steering wheel.

Configuring settings

With the ignition switched on you can change the settings of MDrive on the Control Display.

iDrive, for explanation of principle, refer to page 16.

1. Press the **MENU** button.
This opens the start menu.



2. Press the controller to open the **i** menu.

3. Select "MDrive" and press the controller.



The functions contained in MDrive are displayed:

- ▷ "SMG Drivelogic"
Sequential Manual Transmission with Drivelogic: shifting modes and Drivelogic driving programs, refer to page 62
- ▷ "EDC"
Programs of the Electronic Damping Control, refer to page 84
- ▷ "DSC"
Dynamic Stability Control and M Dynamic Mode, refer to page 82
- ▷ "POWER"
Programs of the M Engine Dynamic Control, refer to page 64
- ▷ "Head-Up Display"*
Views of the Head-Up Display, refer to page 91

You can reset all settings for MDrive to their default values:

- ▷ "Reset to default"

4. Select the desired function.

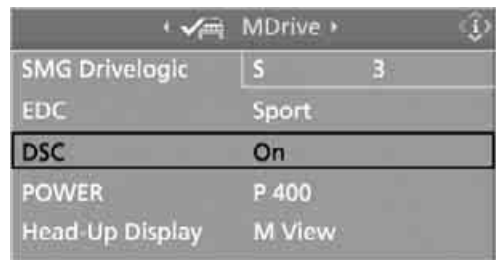

5. Press the controller.

- Turn the controller to select the desired setting.

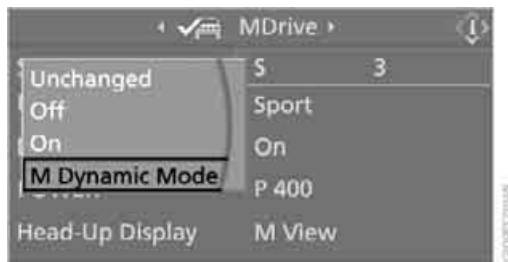



"Unchanged" retains the current setting made outside of MDrive.

- Press the controller.



The setting is stored for the remote control currently in use.

Activating settings

Press the  button on the steering wheel.

 The indicator lamp in the instrument cluster lights up. The settings made on the Control Display for the functions contained in MDrive are active.

Pressing the button again deactivates MDrive.

 If the indicator lamp flashes after pressing the button, MDrive was unable to react, as the ABS Antilock Brake System or DSC Dynamic Stability Control is currently controlling the vehicle stability. Press the  button again when the indicator lamp no longer flashes. ◀

Even with MDrive activated, you can change individual settings outside MDrive, e.g. with the buttons in the center console. To reactivate all settings made for MDrive on the Control Display: press the  button twice.

Transporting children safely

The right place for children

⚠ Do not leave children unattended in the vehicle; otherwise, they could endanger themselves and other persons, e.g. by opening the doors. ◀

Children always in the rear

Accident research shows that the safest place for children is in the back.

⚠ Children younger than 13 years of age or with a height under 5 ft/150 cm may only be transported in the rear in child restraint systems which correspond to the age, weight and height of the child. Otherwise, there is an increased danger of injury in an accident. ◀

Children 13 years of age or older must wear a safety belt as soon as a suitable child restraint system can no longer be used due to their age, size and weight.

Exception for front passenger seat

⚠ Should it be necessary to use a child restraint system on the front passenger seat, the front, knee and side airbags on the passenger side must be deactivated. Otherwise, there is an increased risk of injury for the child if the airbags are triggered, even with a child restraint system. ◀

For more information on automatic deactivation of the front passenger airbags, refer to page 89.

Installing child restraint systems

⚠ Follow child restraint system manufacturer's instructions for the selection, installation and use of child restraint systems. Otherwise, the degree of protection they offer may be reduced. ◀

On front passenger seat

⚠ After mounting a child restraint system on the front passenger seat, make sure that the front and side airbags on the front passenger side are deactivated, as otherwise there is an increased risk of injury if the airbags are triggered. ◀

Backrest width

⚠ Before mounting a child restraint system on the front passenger seat, the backrest width adjustment must be open completely. ◀

1. Adjust the backrest width to the fully open position, refer to page 47.
2. Install child's seat.

Child seat security

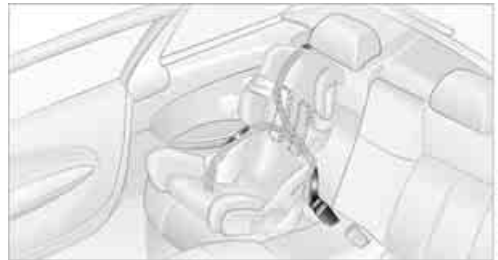

All rear safety belts and the safety belt for the front passenger can be locked against pulling out to secure child restraint systems.

Locking safety belt

1. Secure the child restraint system with the belt.
2. Pull out the belt webbing completely.
3. Allow the belt webbing to be pulled in and pull taut against the child restraint system. The safety belt is locked.

Unlocking safety belt

1. Open the belt buckle.
2. Remove the child restraint system.
3. Allow the belt webbing to be pulled in completely.

Coupe: child restraint system with tether strap

! Only use the tether-strap mounting points to secure child restraint systems, otherwise the mounting points could be damaged. ◀

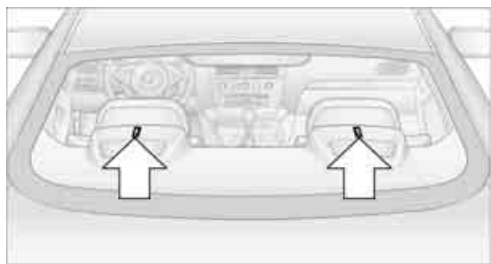

There are two additional mounting points for child restraint systems with a tether strap, refer to arrows.

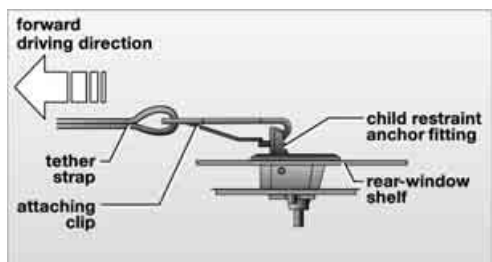

Placement of tether strap

1. Fold anchor fitting into upright position.
2. Push head restraint downward.
3. Guide tether strap over head restraint and hook onto anchor fitting.

LATCH child restraint fixing system

LATCH: Lower Anchor and Tethers for Children.

! When installing and using LATCH child restraint systems, comply with the system manufacturer's operating and safety instructions. ◀

Rear seats

Before attaching the LATCH child's seat, pull the belt away from the region of the child restraint fixing system.

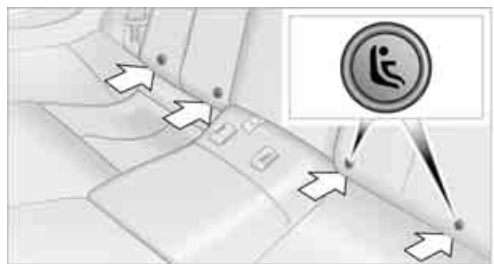

The mounting points for the LATCH anchors are located at the positions indicated by arrows in the gap between the seat and the backrest.

! Make sure that the LATCH anchor fittings are properly engaged and the child restraint system firmly contacts the backrest. ◀

Driving

Ignition lock

Inserting remote control into ignition lock

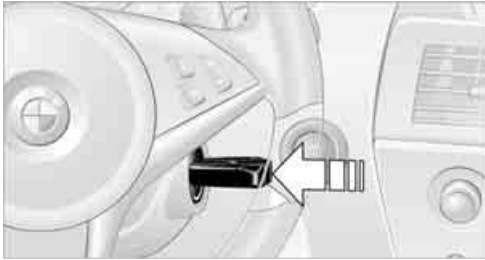

Insert the remote control as far as possible into the ignition lock.

Radio readiness switches on. Some electronic systems/consumers are ready for operation.

Comfort access*

With comfort access, only insert the remote control into the ignition lock in exceptional cases, refer to page 37.

Removing remote control from ignition lock

 Do not pull the remote control out of the ignition lock using force, as otherwise damage may result. ◀

Before removing the remote control, first press it in as far as possible to release the locking device.

The ignition is switched off if it was still switched on.

Start/Stop button



Pressing the Start/Stop button switches the radio readiness or the ignition on and off.

 Manual transmission: the engine starts when you depress the brake pedal while pressing the Start/Stop button. Sequential Manual Transmission: the engine starts when you press the Start/Stop button with the brake depressed and the selector lever in position P or N. ◀

Radio readiness

Some electronic systems/consumers are ready for operation. The last information of the computer selected is displayed in the instrument cluster.

Radio readiness is automatically switched off:

- ▷ when the remote control is removed from the ignition lock
- ▷ with comfort access* by touching the sensitive surface on the door handle, refer to Locking doors on page 37

Ignition on

All electronic systems/consumers are ready for operation. The odometer and the trip odometer are displayed in the instrument cluster, refer to page 68.

 Please switch off the ignition and the electronic systems/consumers which are not required when the engine is not running to save the battery. ◀

Radio readiness and ignition off

All indicator and warning lamps in the instrument cluster go out.

Starting engine

 Do not run the engine in closed rooms, otherwise the inhalation of toxic exhaust gases can cause unconsciousness and death. The exhaust gases contain carbon monoxide, an odorless and colorless, but highly toxic gas. Never leave an unattended vehicle with the engine running, as such a vehicle represents a potential safety hazard.

Before leaving the vehicle with the engine running, shift into neutral* or move the selector lever into position N and firmly apply the handbrake, otherwise the vehicle can begin to roll. ◀

Do not allow the engine to warm up by leaving it running while the vehicle remains stationary. Instead, drive off at a moderate engine speed.

 Avoid frequent starting in quick succession or repeated starting attempts in which the engine does not start. Otherwise, the fuel is not burned at all or is burned inadequately and there is a danger of overheating and damage to the catalytic converter. ◀

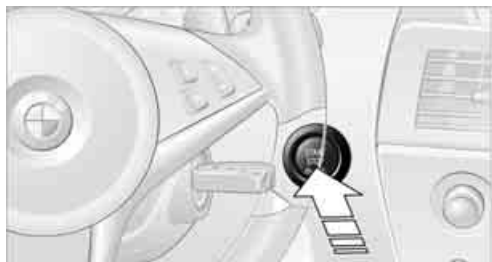

Manual transmission*

Remote control in ignition lock or with comfort access in vehicle, refer to page 37.

1. Depress brake pedal.
2. Depress the clutch pedal and select the idling position.
3. Press the Start/Stop button.

Sequential Manual Transmission with Drivelogic

Remote control in ignition lock or with comfort access in vehicle, refer to page 37.

1. Depress brake pedal.
2. Place selector lever in position N.
3. Press the Start/Stop button.

 If the engine does not start, shift back to the last selector lever position selected, refer to the instrument cluster display or the selector lever. Then select position N. You cannot start off with the hood open. When the engine is cold, the exhaust system has a slightly metallic undertone due to the system design. ◀

Switching engine off

 When leaving the vehicle, always take the remote control with you. When parking, firmly apply the handbrake, as otherwise the vehicle could roll. ◀

Manual transmission*

1. Press the Start/Stop button with the vehicle stopped.
2. Shift into first gear or reverse.
3. Firmly apply the handbrake.
4. Remove the remote control from the ignition lock, refer to page 58.

Sequential Manual Transmission with Drivelogic

1. Firmly apply the handbrake.
2. Move selector lever into a drive position.
3. Press the Start/Stop button. If N is engaged when switching off the engine, this will be pointed out to you optically and acoustically.
4. Remove the remote control from the ignition lock, refer to page 58.

Handbrake

The handbrake is primarily intended to prevent the vehicle from rolling while parked; it brakes the rear wheels.

Indicator lamp

 The indicator lamp lights up, and a signal also sounds when starting off. The handbrake is applied.

 Indicator lamp for Canadian models.

Applying

The lever locks in position automatically.

Releasing



Pull slightly upwards, press the button and lower the lever.

 If exceptional circumstances should make it necessary to apply the handbrake while the vehicle is in motion, do not pull it too firmly. In doing so, continuously press the button of the handbrake lever. Otherwise, too firm an application of the handbrake can lock up the rear wheels and cause the rear of the vehicle to swerve. ◀

 To prevent corrosion and one-sided braking action, occasionally engage the handbrake lightly when the vehicle is slowly coming to a stop if the traffic conditions are suitable. The brake lamps do not light up when the handbrake is applied. ◀

Manual transmission*



 When shifting into 5th/6th gear, press the gearshift lever toward the right, otherwise an inadvertent shift into 3rd or 4th gear could lead to engine damage. ◀

When engaging the 1st gear, a slight jolt may occur. This is operation-related and no reason for concern.

Reverse gear

Select only when the vehicle is stationary. Press the gearshift lever to the left, overcoming a slight resistance.

Shift lights

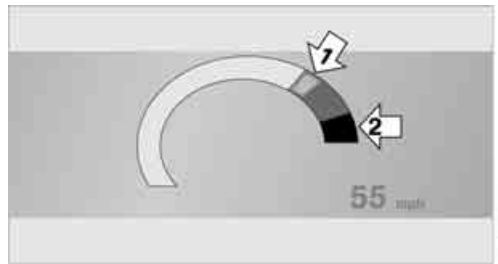

To achieve the best vehicle acceleration with a sporty driving style, shift lights in the Head-Up Display* indicate the optimum shifting point briefly before reaching the maximum rpm. Refer to Shift lights, page 63.

Sequential Manual Transmission with Drivelogic

The concept

The SMG Sequential Manual Transmission with Drivelogic is an automated manual transmission in which an electrohydraulic system handles the clutching and gear changes.

The Sequential Manual Transmission is operated with the selector lever and two shift paddles on the steering wheel.

It offers the following functions:

- ▷ Choice of manual or automatic mode: Sequential mode or Drive mode
- ▷ Selection option between different driving programs, Drivelogic, refer to page 62
- ▷ Upshift display, shift lights, refer to page 63
- ▷ Automatic downshifting and prevention of incorrect shifting even in sequential operation
- ▷ Automatic double clutching

Selector lever positions



- ▷ R: Reverse gear
- ▷ N: Neutral, idle
- ▷ ●: Drive position:
 - ▷ +: manual upshifting
 - ▷ -: manual downshifting
 - ▷ D/S: switch between Drive mode and Sequential mode

Shiftlock

Press the brake pedal before shifting out of N; the shift command will not be executed unless the brake is applied.

R Reverse

Select only when the vehicle is stationary.

N Idle

Always engage before starting engine.

If the driving situation requires, e.g. when downshifting on a slippery road surface, the Sequential Manual Transmission automatically clutches and then declutches again, i.e. it is not necessary to engage idling manually.

 N is automatically engaged after just a few seconds when you open the driver's door or the hood with the engine running and do not operate either pedals, shift paddles or the selector lever. In these cases, to start off after closing the driver's door or the hood, first move the selector lever into the position N and then into the drive position. ◀

S Sequential mode

You can shift up and down using the shifting paddles or the selector lever. You do not need to remove your foot from the accelerator to do so.

After every engine start, as soon as the selector lever is pushed to the right into the drive position ● and the brake pedal is pressed, the Sequential mode is activated.

Starting off is also possible on a level road surface in second gear, e.g. in case of ice.

In the following situations, the Sequential Manual Transmission thinks for you:

- ▷ Upshifts and downshifts are executed only when they will result in a plausible combination of engine and vehicle speed; thus, for example, the system will not execute a downshift that would cause the engine to overrev.
- ▷ When the vehicle is stationary, the transmission automatically downshifts into first gear.
- ▷ Shortly before dropping below a gear-dependent minimum speed, the transmission downshifts automatically even without your intervention.

D Drive mode

In the Drive mode, all forward gears are shifted automatically.

Shifting from Sequential mode to Drive mode: press selector lever to the right toward D/S.

To switch back into the Sequential mode: press the selector lever to the right again toward D/S or shift using the shift paddles or the selector lever.

Kick-down: for rapid acceleration, e.g. passing, press the accelerator pedal as far down as it will go. You achieve maximum acceleration.

Displays in instrument cluster



- 1 Gear 1 to 7, R, N engaged
- 2 Selected driving program, matches the number of illuminated fields, refer to Drivelogic on page 62
- 3 The currently engaged gear is displayed, followed by a D in the Drive mode.

 A flashing gear display indicates to you that the driver's door is open with the engine running.

N is automatically engaged after just a few seconds when you open the driver's door or the hood with the engine running and the vehicle stopped, and do not operate either pedals, shift paddles or the selector lever. ◀

Gear changes

Using selector lever

- ▷ To upshift, pull the selector lever back.
- ▷ To downshift, push the selector lever forward.

Using shift paddles on steering wheel

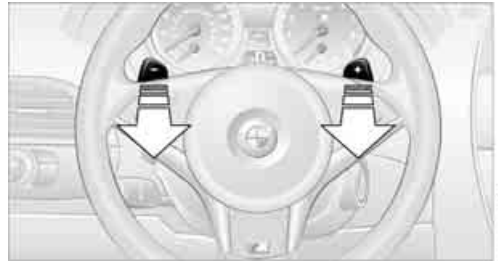

- ▷ To upshift, briefly pull the right shift paddle +.
- ▷ To downshift, briefly pull the left shift paddle -.

Drivelogic

With Drivelogic various driving programs are available to you.

Each time you change between the Sequential mode and the Drive mode, the driving program last selected in the respective mode is active. Exception: after the first change from the Sequential to the Drive mode, driving program 3 is active.

In Drive mode

Five driving programs, from relaxed 1 to sporty/highly dynamic 5 are available for selection.

In Sequential mode

You can choose from six driving programs from balanced/dynamic 1 to sporty/purist 6.

Each time the engine is started, driving program 3 is activated.

The sporty/purist driving program 6 is only available with the DSC Dynamic Stability Control deactivated, refer to page 82. When DSC is activated, the system switches from driving program 6 to 5.

 To maintain vehicle stability, always drive with the DSC switched on when possible. ◀

Selecting driving program with button in center console



Press the button repeatedly until the desired driving program is displayed in the instrument cluster, refer to page 62.

Selecting driving program via button on steering wheel

You can also activate your preferred driving program with the  button on the steering wheel, refer to MDrive on page 54.

With the ignition switched on you can change the settings of MDrive on the Control Display. iDrive, for explanation of principle, refer to page 16.

1. Open the start menu.
2. Press the controller to open the  menu.
3. Select "MDrive" and press the controller.
4. Select "SMG Drivelogic" and press the controller. The first setting is selected.



5. Turn the controller to set Drive mode or Sequential mode.
"Unchanged" retains the current settings made outside of MDrive.

6. Press the controller to select driving programs.
7. Turn the controller to set the driving program.
8. Press the controller.

Shift lights

To achieve the best vehicle acceleration with a sporty driving style in the Sequential mode, shift lights in the Head-Up Display* indicate the optimum shifting point briefly before reaching the maximum rpm.

1. Switch on Head-Up Display, refer to Head-Up Display on page 91.
2. Select display "M View" on Head-Up Display, refer to Selecting displays on page 92.



The current engine speed is highlighted on the tachometer.

3. When approaching the maximum rpm, yellow illuminated fields **1** of the tachometer consecutively indicate the approaching upshift point.
4. Shift at the latest when the red indicator field **2** lights up.

When the permissible maximum rpm is reached, the entire tachometer begins to flash. When the maximum rpm is exceeded, the fuel supply is cut off to protect the engine. Always avoid engine speeds in this range.

M Engine Dynamic Control

With M Engine Dynamic Control you can influence how sporty the reaction of your vehicle to accelerator pedal movements is to be. Three programs are available for engine control.

"P 400" program

In the "P 400" program the engine reacts gently to the movement of the accelerator pedal. This is, for example, ideal for city driving or driving on snow. In the process, the fuel consumption is minimal and the engine output is reduced.

"P 500" program

The "P 500" program provides maximum performance and more spontaneous reaction of the engine to accelerator pedal movements.

"P 500 Sport" program

In the "P 500 Sport" program the engine reacts especially spontaneously and uncompromisingly sporty with maximum performance to accelerator pedal movements.

Selecting program



Each time the engine is started, the "P 400" program is activated.

Press the POWER button to activate the "P 500" program. Pressing the POWER button repeatedly switches between the programs "P 400" and "P 500".

You can also activate your preferred program with the  button on the steering wheel, refer to MDrive on page 54. You can only activate the "P 500 Sport" program with MDrive.

For the programs "P 500" and "P 500 Sport" the LED in the POWER button lights up.

Turn signals/ headlamp flasher

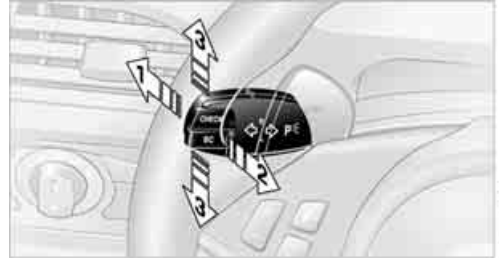

- 1 High beams
- 2 Headlamp flasher
- 3 Turn signals

Using turn signals

Move the lever beyond the resistance point.

To switch off manually, only press the lever to the resistance point.

 Atypically rapid flashing of the indicator lamp indicates the failure of a turn signal lamp. ◀

Signaling briefly

Press the lever to the resistance point and hold it there as long as you wish to signal.

Triple turn signal activation

Press the lever to the resistance point; the turn signals flash three times.

You can activate or deactivate this function.

iDrive, for explanation of principle, refer to page 16.

1. Open the start menu.
2. Press the controller to open the  menu.
3. Select "Settings" and press the controller.
4. Select "Vehicle / Tires" and press the controller.

5. Change to upper field if necessary. Turn the controller until "Lighting" is selected and press the controller.



6. Select "Triple turn signal" and press the controller.

Triple turn signal is activated.

The setting is stored for the remote control currently in use.

Wiper system



- 1 Switching on wipers
- 2 Switching off wipers or brief wipe
- 3 Activating/deactivating rain sensor
- 4 Cleaning windshield and headlamps
- 5 Adjusting rain sensor sensitivity level

Switching on wipers

Pull the lever upward, arrow 1.

The lever automatically returns to its initial position when released.

Normal wiper speed

Press once.

The system reverts to operation in the intermittent mode whenever the vehicle is stationary.

Fast wiper speed

Briefly press twice or press beyond the resistance point.

The system reverts to operation at normal speed whenever the vehicle is stationary.

Rain sensor

Wiper operation is controlled automatically as a function of the rain intensity. The rain sensor is located on the windshield, directly in front of the interior rearview mirror.

Activating rain sensor

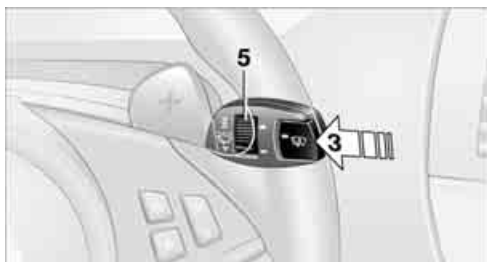

Press the button, arrow 3. The LED in the button lights up.

Adjusting rain sensor sensitivity level

Turn the knurled wheel 5.

Deactivating rain sensor

Press the button again, arrow 3. The LED goes out.



Deactivate the rain sensor when passing through an automatic car wash. Failure to do so could result in damage caused by undesired wiper activation. ◀

Cleaning windshield and headlamps

Pull the lever, arrow 4:

The system sprays washer fluid against the windshield and activates the wipers for a brief period.

When the vehicle lighting is switched on, the headlamps are simultaneously washed at appropriate intervals.

⚠ Do not use the washers if there is any danger that the fluid will freeze on the windshield. If you do so, your vision could be obscured. To avoid freezing, use a washer fluid antifreeze, refer to Washer fluid. Do not use washers when the washer fluid reservoir is empty, as this will damage the washer pump. ◀

Windshield washer nozzles

Both windshield washer nozzles are automatically heated with the engine running or the ignition switched on.

Washer fluid

⚠ Washer fluid antifreeze is flammable. Always keep it well away from sparks and open flames, and store it in tightly closed containers well out of the reach of children. Always follow the instructions for use provided on the containers. ◀

Filler neck for washer fluid

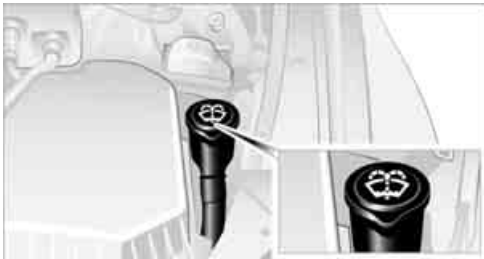

All washer nozzles are supplied from one reservoir.

Fill with water and – if required – with a washer antifreeze, according to manufacturer's recommendations.

In order to maintain the mixture ratio, mix the washer fluid before filling. ◀

Capacity

Capacity approx. 5.3 US quarts/5 liters.

Cruise control

The concept

The cruise control is available for use at speeds of approx. 20 mph/30 km/h and higher. The vehicle stores and maintains the speed that you set using the lever mounted on the steering column.

⚠ Do not use the cruise control under driving conditions that do not permit a constant speed, e.g. when driving on winding roads, in heavy traffic or in poor road conditions such as snow, rain, ice, and loose road surface. Otherwise, you could lose control of the vehicle and cause an accident. ◀

One lever for all functions

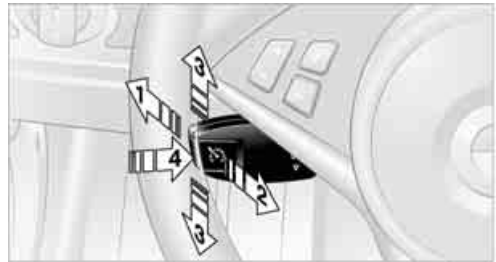

- 1 Maintaining speed, storing speed, and accelerating
- 2 Maintaining speed, storing speed, and decelerating
- 3 Interrupting cruise control
- 4 Resuming stored speed

Maintaining speed, storing speed, and accelerating

Press lever to resistance point, arrow **1**:

The system maintains and stores the current vehicle speed. The display **1** in the speedometer, see below, indicates this regulated speed. Every time you press the lever, the vehicle's speed increases by roughly 1 mph/1 km/h.

Press the lever to the resistance point and hold it:

The vehicle accelerates without pressure on the accelerator pedal. The system maintains

and stores your current speed as soon as you release the lever.

Press the lever beyond the resistance point: Increase speed each time to the next fives place on the mph speedometer or to the next tens place on the km/h speedometer.

If, on a downhill grade, the engine's braking effect is not sufficient, the controlled speed can be exceeded. Speed can drop on uphill grades if the engine output is insufficient.

Maintaining speed, storing speed, and decelerating

Pull the lever, arrow **2**:

Functions are the same as **1**, only the vehicle speed is reduced.

Interrupting cruise control

Press the lever up or down, arrow **3**.

Cruise control is also interrupted automatically:

- ▷ When you apply pressure to the brake pedal
- ▷ When you shift manually with the shift paddles or the selector lever
- ▷ When DSC controls

Resuming stored speed

Press button **4**:

The vehicle accelerates to and maintains the stored speed.

Deactivating system

When the ignition is switched off, the system is deactivated and the stored speed is deleted.

Displays in instrument cluster



- 1 Stored speed
- 2 Selected speed is displayed briefly

Everything under control

Odometer, outside temperature display, clock



- 1 Time, outside temperature, refer to Computer on page 69
- 2 Odometer and trip odometer
- 3 Press button:
 - ▷ with ignition switched on, trip odometer is reset
 - ▷ with ignition switched off, odometer is briefly displayed

Tachometer



The advance warning field, arrow 1, and the red warning field, arrow 2, change depending on the engine temperature. As the engine temperature rises, the permissible engine speed also increases.

Avoid allowing the engine speed to rise as far as the advance warning field whenever possible.

Always avoid engine speeds in the red warning field.

In this range, the fuel supply is interrupted to protect the engine.

Coolant temperature

Should the coolant and therefore the engine become too hot, a warning lamp lights up. In addition, a message appears on the Control Display.

Checking coolant level, refer to page 205.

Engine oil temperature gauge



The general operating temperature lies between 175 °F /80 °C and 250 °F /120 °C. Do not exceed a value of approx. 265 °F /130 °C. If the engine oil temperature is too high, the permissible engine speed, and with it the available engine output is reduced.

Fuel gauge



Fuel tank capacity: approx. 18.5 US gal/ 70 liters. You can find information on refueling on page 194.

If the tilt of the vehicle varies for a longer period, when you are driving in mountainous areas, for example, the indicator may fluctuate slightly.

Reserve

After the reserve quantity has been reached, a message briefly appears on the Control Display; the cruising range is shown in the computer. Below a range of approx. 30 miles/50 km, the message remains on the Control Display.

 Refuel as soon as possible once your cruising range falls below 30 miles/ 50 km, otherwise engine functions are not ensured and damage can occur. ◀

Computer

Displays in instrument cluster



To display the information, press the BC button in the turn signal lever.

The following information is displayed in the specified order:

- ▶ Time and outside temperature
- ▶ Cruising range
- ▶ Average fuel consumption
- ▶ Oil level, refer to Checking engine oil level on page 203



Manual transmission:

The range, average consumption and fluid level are shown in the lower display in place of the gear indicator.

It is possible to change between the time and date display by pressing the CHECK button. ◀

Time

To set the time, refer to page 76.

Outside temperature warning

If the display drops to +37 °F /+3 °C, a signal sounds and a warning lamp lights up. A message appears on the Control Display. There is an increased danger of ice.



Ice can form even at temperatures above +37 °F /+3 °C. Drive carefully, especially on bridges and shaded roadways; otherwise, your risk of accident increases. ◀

You can set the unit of measure °F or °C on the Control Display, refer to Units of measure on page 78.

Cruising range

Displays the estimated cruising range available with the remaining fuel. The range is projected based on the driving style over the last 20 miles/ 30 km.

 Refuel as soon as possible once your cruising range falls below 30 miles/ 50 km, otherwise engine functions are not ensured and damage can occur. ◀

Average fuel consumption

The average fuel consumption is calculated for the time during which the engine is running.

To reset the average fuel consumption: press the BC button in the turn signal lever for approx. 2 seconds.

For different routes

You can display the average speed for two different routes on the Control Display, refer to the following and to Trip computer.

Displays on Control Display

You can also call up the computer via iDrive, for explanation of principle, refer to page 16.

1. Press the **MENU** button.
This opens the start menu.
2. Move the controller to the right to open "Navigation".
Without navigation system*: open "Car Data".
3. Select "Car Data" and press the controller.

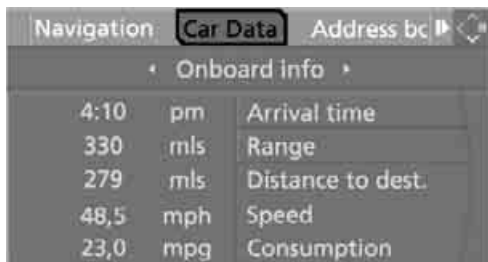

4. Select "Onboard info" and press the controller.



- ▷ Estimated time of arrival at destination and remaining distance:
 - ▷ Entering a distance manually in the computer, see below.
 - ▷ Entering a destination in the navigation system*, refer to page 122.
- ▷ Cruising range
- ▷ Average speed
- ▷ Average fuel consumption

Periods with the vehicle parked and the engine switched off are not included in the calculations of average speed.

Resetting values

You can reset the values for average speed and average fuel consumption:

1. Select the desired menu item and press the controller.
2. Press the controller again to confirm.

Entering a distance manually

1. Select "Distance to dest." and press the controller.

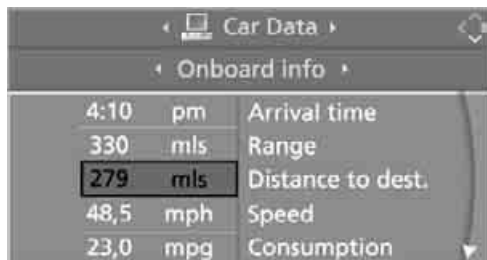

- Turn the controller to select the distance to your destination. If necessary, hold it against a slight resistance to enter a greater difference.
- Press the controller to apply the setting.

The distance is automatically predetermined during the destination guidance of the navigation system*.

Trip computer

The trip computer is suitable for a vacation trip, for example.

- Open the start menu.
- Open "Navigation".
Without navigation system*: open "Car Data".
- Select "Car Data" and press the controller.
- Select "Trip computer" and press the controller.



- ▶ Departure time
- ▶ Driving time
- ▶ Distance traveled
- ▶ Average speed
- ▶ Average fuel consumption

Switching trip computer on/off and resetting all values:

- Select "Set" and press the controller.
- Select the desired menu item and press the controller.

Display options

You can display the computer or the trip computer in the assistance window.

- Move the controller to the right to change to the assistance window and press the controller.



- Select a menu item:
 - ▶ "Onboard info"
 - ▶ "Trip computer".
- Press the controller.



Service requirements



The remaining driving distance and the date for the next maintenance are displayed briefly with the ignition switched on.

The first oil change displayed at approx. 1,200 miles/2,000 km signals that the break-in check is due.

 Your BMW Service Advisor can determine your vehicle's current service requirements by reading out the data stored in the remote control. ◀

Additional information

You can view more detailed information by using the Control Display, for explanation of principle, refer to page 16.

1. Open the start menu.
2. Press the controller to open the **i** menu.
3. Select "Info sources" and press the controller.
4. Select "Service" and press the controller.
5. Change to upper field if necessary. Turn the controller until "Service requirements" is selected and press the controller.

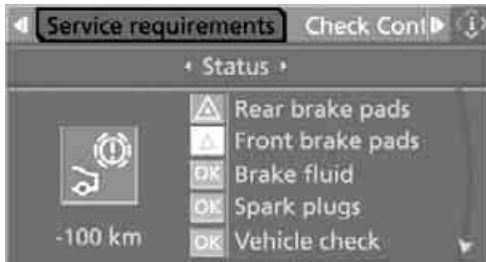

6. Select "Status" and press the controller.

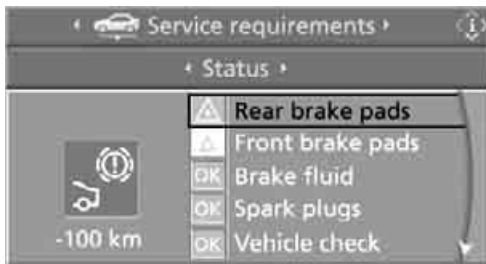

The display shows a list of selected service and maintenance procedures, as well as legally mandated official inspections.

You can request more detailed information on every entry.



Select the entry and press the controller.



To exit from the menu:

Select the  arrow and press the controller.

Symbols

-  No service is currently required.
-  The deadline for service or an official inspection is approaching. Please arrange a service appointment.
-  The service deadline has already passed.

Entering deadlines for legally required inspections*

Make sure the date on the Control Display is set correctly, refer to page 78; otherwise, the effectiveness of CBS Condition Based Service is not ensured.

1. Open the start menu.
2. Press the controller to open the **i** menu.
3. Select "Info sources" and press the controller.
4. Select "Service" and press the controller.
5. Change to upper field if necessary. Turn the controller until "Service requirements" is selected and press the controller.
6. Select "Status" and press the controller.

7. Select "State inspection" and press the controller.

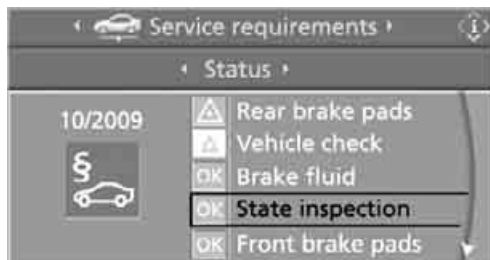

8. Select "Set service date" and press the controller. The month is selected.
9. Turn the controller to make the adjustment.



10. Press the controller to apply the setting. The year is selected.
11. Turn the controller to make the adjustment.
12. Press the controller to apply the setting. The date entry is stored.

To exit from the menu:

Select the  arrow and press the controller.

Check Control

The concept

The Check Control monitors functions in the vehicle and issues a message if there is a malfunction in the monitored systems. A Check Control message of this kind includes indicator or warning lamps in the instrument cluster, possibly an acoustic signal, and text messages at the bottom of the Control Display.

Indicator and warning lamps



The indicator and warning lamps can light up in different combinations and colors.



▲ This symbol means that a Check Control message has been generated. The symbol remains visible even if the Check Control message has been hidden after a short time. The combinations of warning lamps and text messages are stored and can be viewed later, also refer to page 74.

Explanatory text messages



Text messages at the bottom edge of the Control Display explain the meaning of the indicator and warning lamps displayed.

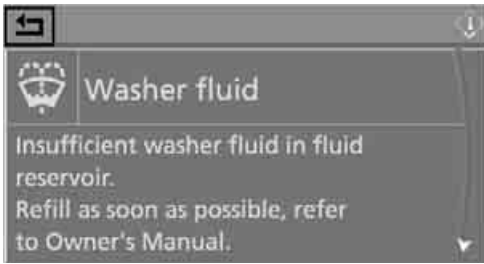

You can display supplementary information regarding most Check Control messages, e.g. as to the cause of a malfunction and corresponding actions to be taken, see below.

In urgent cases, this information will be shown as soon as the corresponding lamp lights up.

To exit the displayed information:

Select the  arrow and press the controller.

Displaying stored Check Control messages

1. Press the button longer:
The first stored message is displayed.

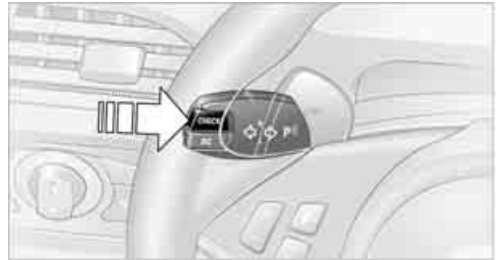

2. Press the button:
A new message appears each time you press the button.

Hiding Check Control messages

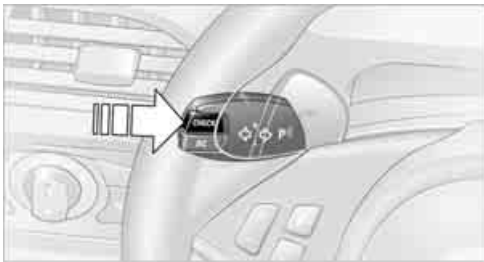

Press the CHECK button in the turn signal lever.

Some Check Control messages are displayed until the malfunctions have been rectified. They cannot be hidden. If a number of these malfunctions occur simultaneously, they are displayed in succession.

Other messages are automatically hidden after approx. 20 seconds, but remain stored.

Displaying supplementary information

iDrive, for explanation of principle, refer to page 16.

1. Press the **MENU** button.
This opens the start menu.
2. Press the controller to open the **i** menu.
3. Turn the controller until "Info sources" is selected and press the controller.



4. Turn the controller until "Service" is selected and press the controller.
5. Change to upper field if necessary. Turn the controller until "Check Control messages" is selected and press the controller.

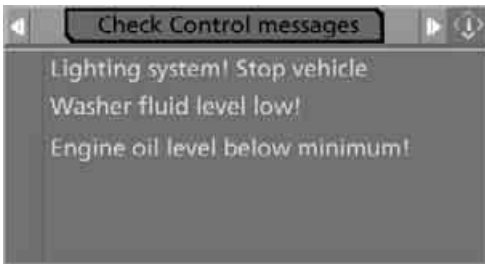

6. Select a message and press the controller.

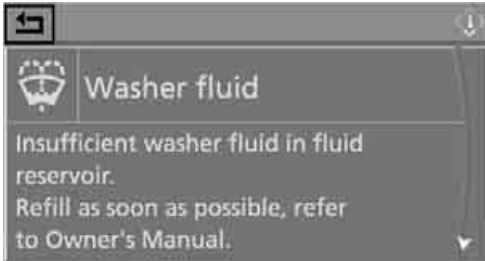

To exit from the menu immediately:
Select the arrow and press the controller.

Displaying the urgency of malfunctions

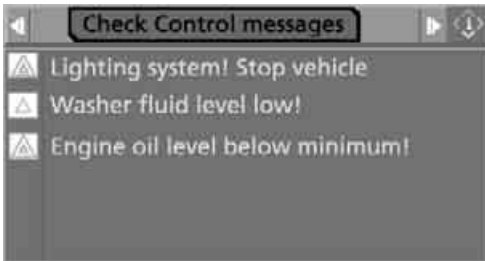

Depending on the equipment, the stored Check Control messages are also displayed with the following symbols:

- No malfunctions detected in the monitored systems.
- Malfunctions detected in the monitored systems. Depending on the malfunction, supplementary information is shown on the Control Display.
- Malfunctions detected in the monitored systems. Depending on the malfunction, supplementary information is shown on the Control Display.

The symbols also indicate the status of the service requirements display, refer to page 71.

Displays after completion of trip

Malfunction reports generated during the trip are shown consecutively when you switch off the ignition.

Before the display disappears, you can display the messages once again. Press the CHECK button for approx. 2 seconds. If several messages are present, you can press the CHECK button repeatedly.

The display:

- ▷ turns off automatically after a brief period
- ▷ can be turned off at any time by pressing the CHECK button again for approx. 2 seconds

Speed limit

You can enter a speed and a Check Control message indicates when you have reached this speed. This enables you, for example, to receive warnings if you exceed a speed limit in an urban area.

You are only warned of reaching this speed a second time if your vehicle speed falls below it again by at least 3 mph/5 km/h.

Displaying, setting or changing limit

iDrive, for explanation of principle, refer to page 16.

1. Open the start menu.
2. Open "Navigation".
Without navigation system*: open "Car Data".
3. Select "Car Data" and press the controller.
4. Select "Limit" and press the controller.



5. Select the speed value and press the controller.
6. Turn the controller to set the limit. If necessary, hold it against a slight resistance to enter a greater difference.
7. Press the controller to apply the setting. The limit is automatically switched on.

Applying your current speed as limit

Select "Select current speed" and press the controller. The system applies your current speed as the limit.

Activating limit

Select "On" and press the controller.

The limit is automatically switched on.

Stopwatch

iDrive, for explanation of principle, refer to page 16.

1. Open the start menu.
2. Open "Navigation".
Without navigation system*: open "Car Data".
3. Select "Car Data" and press the controller.
4. Select "Stopwatch" and press the controller.



Starting, stopping, or resetting

- ▷ Select "Start" and press the controller. The stopwatch starts at the displayed time.
- ▷ Select "Reset" and press the controller. The stopwatch is reset and it restarts if it was running beforehand.

- ▷ Select "Stop" and press the controller. This stops the timer.

Taking an intermediate time reading

Select "Interim time" and press the controller. The interim time appears below the ongoing primary stopwatch count.

- ▷ All of the remaining functions remain available at all times while the stopwatch is running. The stopwatch continues to operate in the background. ◀

Settings on Control Display

iDrive, for explanation of principle, refer to page 16.

1. Press the **MENU** button once or twice until the start menu appears.



2. Press the controller to open the **i** menu.
3. Turn the controller until "Settings" is selected and press the controller.



Setting time

1. Turn the controller until "Time / Date" is selected and press the controller.



2. Move the controller once to the front if necessary to change to the first field from the top.

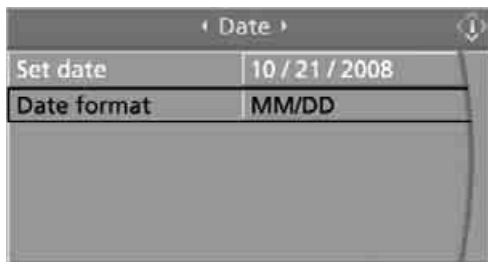

3. Turn the controller until "Time" is selected and press the controller.

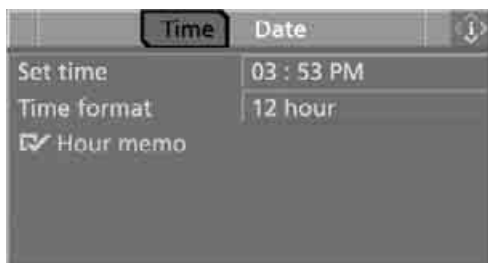

4. Turn the controller until "Set time" is selected and press the controller.

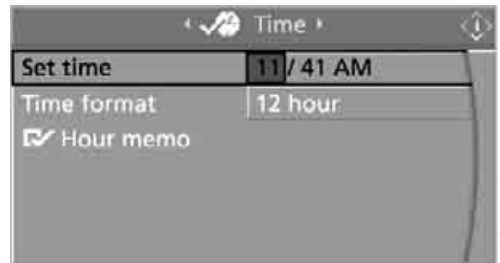

Making settings

1. Turn the controller to set the hours and press the controller.
2. Turn the controller to set the minutes and press the controller.

The changed time is stored.

Activating hour signal*

You will hear three tones just before each full hour.

Select "Hour memo" and press the controller.

The hour signal is activated.

The setting is stored for the remote control currently in use.

Setting time format

1. Select "Time format" and press the controller.
2. Select the desired format and press the controller.

The setting is stored for the remote control currently in use.

Setting date

1. Select "Date" and press the controller.



2. Select "Set date" and press the controller. The first section of the date display is selected, in this case the month.
3. Turn the controller to make the adjustment.
4. Press the controller to apply the setting. The next adjustment is selected.
5. Make the remaining adjustments. After the last adjustment, the date is stored.

Changing date format

1. Select "Date format" and press the controller.
2. Select the desired format and press the controller.

The setting is stored for the remote control currently in use.

Brightness of Control Display

The brightness is automatically adapted to the ambient lighting conditions. However, you can change the base setting.

iDrive, for explanation of principle, refer to page 16.

1. Press the **MENU** button. This opens the start menu.
2. Press the controller to open the **i** menu.
3. Select "Settings" and press the controller.
4. Select "Display settings" and press the controller.

5. Change to upper field if necessary. Turn the controller until "Brightness" is selected and press the controller.



6. If necessary, move the controller to the right to select "Display".
7. Turn the controller until the desired setting is selected.

The setting is stored for the remote control currently in use.

Units of measure

You can change the units of measure for fuel consumption, distances, temperature and pressure.

iDrive, for explanation of principle, refer to page 16.

1. Press the **MENU** button. This opens the start menu.
2. Press the controller to open the **i** menu.
3. Select "Settings" and press the controller.
4. Select "Language / Units" and press the controller.
5. Change to upper field if necessary. Turn the controller until "Units" is selected and press the controller.

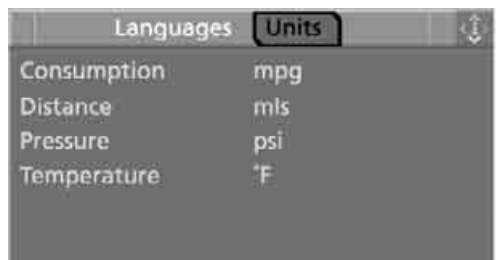

6. Select the menu item to be set.

7. Press the controller.
8. Select the desired unit of measure and press the controller.

The settings are stored for the remote control currently in use.

Language on Control Display

iDrive, for explanation of principle, refer to page 16.

1. Press the **MENU** button.
This opens the start menu.
2. Press the controller to open the **i** menu.
3. Select "Settings" and press the controller.
4. Select "Language / Units" and press the controller.
5. Change to upper field if necessary. Turn the controller until "Languages" is selected and press the controller.

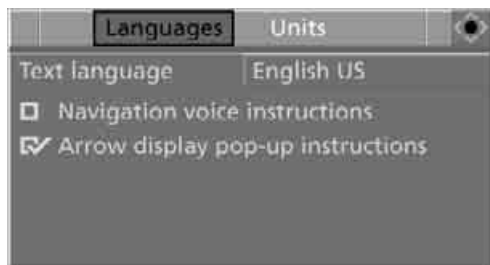

6. Select "Text language" and press the controller. You can select a different language for the text displays.
7. Select the desired language and press the controller.

The setting is stored for the remote control currently in use.

Technology for comfort, convenience and safety

PDC Park Distance Control*

The concept

The PDC assists you when you are parking. Acoustic signals and an optical display* alert you to the approach of an object from behind your vehicle. To measure the distance, there are four ultrasonic sensors in each bumper. The range of these sensors is approx. 7 ft/2 m. However, an acoustic warning first sounds for the sensors at the front and at the two rear corners at approx. 24 in/60 cm, and for the center rear sensors at approx. 5 ft/1.50 m.

 PDC is a parking aid that can indicate the presence of objects when they are being approached slowly, as is usually the case when parking. Avoid approaching an object at high speed; otherwise, the physical circumstances could cause the system warning to be activated too late. ◀

Switching on automatically

The system starts to operate approx. 1 second after you shift into reverse gear or move the selector lever into position R with the engine running or the ignition switched on.

Wait this short period before driving.

Switching on manually



Press the button; the LED lights up.

Switching off manually

Press the button again; the LED goes out.

After driving approx. 165 ft/50 m or at over approx. 20 mph/30 km/h, the system is switched off and the LED goes out. You can reactivate the system manually as needed.

Signal tones

An intermittent signal indicates the distance of the vehicle from an object being approached. Thus, an object detected to the left rear of the vehicle will be indicated by a signal tone from the left rear speaker, etc. As the distance between vehicle and object decreases, the intervals between the tones become shorter. If the distance to the nearest object falls to below roughly 1 ft/30 cm, then a continuous tone sounds.

An intermittent tone is interrupted after approx. 3 seconds:

- ▷ if you remain in front of an object that was only detected by one of the corner sensors
- ▷ if you drive parallel to a wall

Malfunction

The LED in the button flashes and a message appears on the Control Display. PDC is malfunctioning. Have the system checked.

As a preventive measure, keep the sensors clean and free of ice or snow in order to ensure that they will continue to operate effectively. Do not spray the sensors with high-pressure cleaners for long periods and maintain a distance of at least 4 in/10 cm to them.

Exhaust gases near the rear sensors can cause a signal tone to sound.

PDC with visual warning*

You can also enjoy the option of having the system show the approach to an object on the Control Display. Objects that are farther away are already shown there before a signal tone sounds. The setting is stored for the remote control currently in use.

iDrive, for explanation of principle, refer to page 16.

1. Press the **MENU** button.
This opens the start menu.
2. Press the controller to open the **i** menu.



3. Turn the controller until "Settings" is selected and press the controller.
4. Turn the controller until "Vehicle / Tires" is selected and press the controller.
5. Change to upper field if necessary. Turn the controller until "PDC" is selected and press the controller.



6. Select "PDC display on" and press the controller.
 The PDC screen is activated.

The display appears on the Control Display as soon as PDC is activated.

System limits

 Even with PDC, final responsibility for estimating the distance between the vehicle and any obstacles always remains with the driver. Even when sensors are involved, there is a blind spot in which objects cannot be detected. The system is also subject to the physical limits that apply to all forms of ultrasonic measurement, such as those encountered with tow bars and trailer couplings, or thin and wedge-shaped objects etc. Low objects already displayed, e.g. curbs, can also disappear from the detection area of the sensors again before or after a continuous tone already sounds. Higher, protruding objects, e.g. ledges, cannot be detected.

Loud noises from outside and inside the vehicle may prevent you from hearing the PDC signal tone. ◀

Driving stability control systems

Your BMW is equipped with an extended array of systems designed to enhance and maintain vehicle stability under extreme conditions.

ABS Antilock Brake System

ABS prevents the wheels from locking during braking. Safe steering response is maintained even during hard braking. This increases active driving safety.

ABS is operational every time you start the engine. For information on safe braking, refer to page 116.

CBC Cornering Brake Control

This system provides further enhancements to vehicle stability and steering response when braking while cornering or when braking during a lane change.

Electronic brake-force distribution

This system controls the brake system's application pressure at the rear wheels to ensure stable deceleration.

Brake assistant

When you apply the brakes rapidly, this system automatically produces the maximum braking force boost and thus helps to achieve the shortest possible braking distance during full braking. This system exploits all of the benefits provided by ABS.

Do not reduce the pressure on the brake pedal for the duration of the full braking.

DSC Dynamic Stability Control

DSC optimizes the vehicle stability and traction. It also detects unstable driving states such as understeering and oversteering, and helps keep the vehicle on course within the physical limits by reducing the engine output and by braking at the wheels.

The DSC is operational every time you start the engine.

 The laws of physics cannot be repealed, even with DSC. An appropriate driving style always remains the responsibility of the driver. Do not reduce the additional safety margin of the system by taking risks. ◀

Indicator lamp

 The indicator lamp goes out shortly after the engine is started. The indicator lamp flashes: DSC is controlling the drive forces and brake forces. The indicator lamp lights up continuously: DSC is deactivated.

M Dynamic Mode MDM

The M Dynamic Mode is a mode of the DSC Dynamic Stability Control. It enables driving with greater longitudinal and lateral acceleration on dry road surfaces, however with limited vehicle stability. The system does not provide stabilizing intervention by reducing the engine output and braking at the wheels until the absolute driving limit is reached. Steering corrections by the driver may also be required in this driving state.

The M Dynamic Mode is deactivated each time the engine is started.

 With the M Dynamic Mode activated, stabilizing interventions are only carried out to a reduced degree. ◀

 To maintain vehicle stability, drive with DSC activated and the M Dynamic Mode deactivated whenever possible. ◀

Indicator lamp

 The indicator lamp goes out shortly after the engine is started. The indicator lamp lights up continuously:

M Dynamic Mode is activated.

The indicator lamp lights up continuously and the DSC indicator lamp flashes: the M Dynamic Mode is active and controls the drive and braking forces.

Activating MDM

You activate the M Dynamic Mode with the  button on the steering wheel, refer to MDrive on page 54.

With the ignition switched on you can change the settings of MDrive on the Control Display. iDrive, for explanation of principle, refer to page 16.

1. Press the **MENU** button.
This opens the start menu.
2. Press the controller to open the **i** menu.
3. Select "MDrive" and press the controller.
4. Select "DSC" and press the controller.
5. Select "M Dynamic Mode" and press the controller.

Sequential Manual Transmission with Drive-logic:

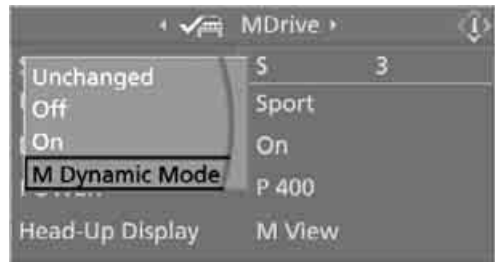

Manual transmission:

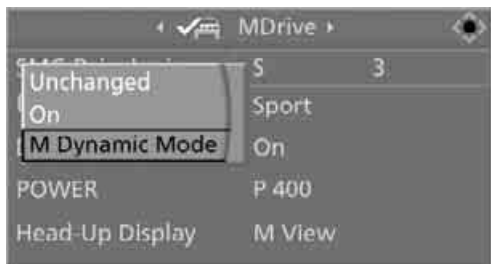

You can also activate and deactivate the M Dynamic Mode with the MDM button.

Deactivating MDM again

Press the  button on the steering wheel or the MDM button* again; the MDM indicator lamp goes out.

Deactivating DSC*



Press the DSC OFF button; the DSC indicator lamp lights up continuously. DSC and MDM are deactivated.

A message appears on the Control Display. Please note any supplementary information that appears there.

When rocking free and starting off from deep snow or on loose road surfaces, it may be practical to briefly deactivate DSC.

 To maintain vehicle stability, always drive with the system switched on when possible. With a manual transmission, DSC cannot be deactivated. ◀

Reactivating DSC

Press the DSC OFF button; the indicator lamp in the instrument cluster goes out.

You can also activate and deactivate DSC with the  button on the steering wheel, refer to MDrive on page 54.

Malfunction in driving stability control systems

 The warning lamp for the brake system lights up, together with the Indicator and warning lamps for ABS, DSC and Tire Pressure Monitor or Flat Tire Monitor. A message appears on the Control Display. The driving stability control systems have failed. Conventional braking efficiency remains available without limitations. While you may continue, you should remember to proceed cautiously and drive defensively while avoiding full brake applications. In addition, the Tire Pressure Monitor or the Flat Tire Monitor has also failed. Have the system checked as soon as possible.

 Display of the previously described malfunction on Canadian models.

 ABS

 The DSC warning lamp lights up. A malfunction has occurred in DSC including MDM. The stability maintenance functions are no longer available.

The vehicle remains operational. Have the system checked as soon as possible.

BRAKE

The brake system warning lamp lights up yellow. A message appears on the Control Display. The brake assistant is defective. Have the system checked as soon as possible.



Display of the previously described malfunction on Canadian models.

EDC Electronic Damping Control

The concept

If the influencing variables such as road surface quality or operating conditions such as steering, braking etc. change, the damping automatically adjusts to the new conditions within a fraction of a second.

You can choose from three programs.

"Comfort" program

Select the "Comfort" program if you want comfort-oriented coordination of shock absorbers and steering.

"Normal" program

The "Normal" program offers a balanced mixture of the comfort and the sport program.

"Sport" program

Select the "Sport" program if you want a consistently sporty coordination of shock absorbers and steering.

Selecting program

Sequential Manual Transmission with Drive-logic:



Manual transmission:



Press the EDC button repeatedly:

- ▷ "Comfort": LED off.
- ▷ "Normal": one LED lights up.
- ▷ "Sport": both LEDs light up.

The last selected program is active each time the engine is started.

You can also activate your preferred program with the  button on the steering wheel, refer to MDrive on page 54.

FTM Flat Tire Monitor*

The concept

The Flat Tire Monitor keeps track of the inflation pressures in the tires as you drive. The system provides an alert whenever the inflation pressure drops significantly in relation to the pressure in another tire.

In the event of a pressure loss, the rolling radius and therefore the rotation speed of the wheels

change. This change is detected and signaled as a flat tire.

Functional requirement

To ensure the reliable signaling of a flat tire, the system must be initialized at the correct tire inflation pressure.

 The initialization must be repeated after every correction of the tire inflation pressure and after every tire or wheel change. ◀

System limits

 The Flat Tire Monitor cannot indicate sudden severe tire damage caused by outside factors and does not detect a natural, even pressure drop in all four tires. ◀

In the following situations, the system could be delayed or malfunction:

- ▶ System has not been initialized
- ▶ Driving on snow-covered or slippery roads
- ▶ Sporty driving style: slip in the drive wheels, high lateral acceleration
- ▶ Driving with snow chains*

Initializing system

 The initialization finishes during driving, which can be interrupted at any time.

When driving resumes, the initialization is automatically continued.

Do not initialize the system when driving with snow chains*. ◀

With Sequential Manual Transmission via the button in the center console:

1. Start the engine, but do not start driving.
2. Press the button at least 4 seconds, however not longer than 2 minutes. After releasing the button, the warning lamp in the instrument cluster lights up yellow for a few seconds. Warning lamp, refer to Indication of a flat tire. The message "Initializing FTM..." appears on the Control Display for a few seconds.



3. Start to drive. The initialization finishes during driving without feedback.

Via iDrive, for explanation of principle, refer to page 16:

1. Press the **MENU** button. This opens the start menu.
2. Press the controller to open the **i** menu.



3. Turn the controller until "Settings" is selected and press the controller.
4. Select "Vehicle / Tires" and press the controller.
5. Change to upper field if necessary. Turn the controller until "FTM" is selected and press the controller.

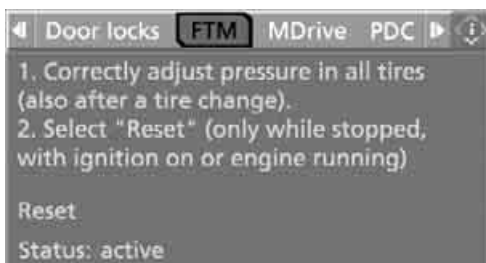

6. Start the engine, but do not start driving.
7. Select "Reset" and press the controller.

- Select "Yes" and press the controller.



The message "resetting FTM ..." is displayed for a few seconds. The warning lamp in the instrument cluster lights up yellow for a few seconds.

- Start to drive.
The initialization finishes during driving without feedback.

Indication of a flat tire



The warning lamp lights up in red. A message appears on the Control Display. In addition, an acoustic signal sounds. There is a flat tire or extensive inflation pressure loss.

- Reduce speed and stop the vehicle carefully. Avoid sudden braking and steering maneuvers.
- Identify damaged tire. To do this, check the tire inflation pressure using the M Mobility System, refer to Producing tire inflation pressure on page 214.
- Repair flat tire with M Mobility System, refer to page 212, or replace the damaged wheel, refer to Changing wheels on page 215.

TPM Tire Pressure Monitor*

The concept

TPM checks the tire inflation pressure in the four mounted tires. The system reports when the tire inflation pressure has dropped considerably in one or several tires.

Functional requirement

In order to assure the reliable reporting of a flat tire, the system must have been reset with the correct tire inflation pressure.

Always use wheels with TPM electronics, otherwise fault-free operation of the system is not ensured.



Reset the system again after each correction of the tire inflation pressure and after every tire or wheel change. ◀

System limits



TPM cannot announce sudden serious tire damage caused by external influences. ◀

The system does not function properly if it has not been reset, e.g. a flat tire is reported despite correct tire inflation pressures.

The system is inactive and cannot display a flat tire if a wheel has been mounted without TPM electronics, or if TPM is temporarily interfered with by other systems or devices which use the same radio frequency.

Status display on Control Display

The tire and system status is indicated by the color of the tires.

TPM takes the fact that the tire pressure changes during driving into account. A correction is only required if requested by TPM with the color.

Green

The tire pressure matches the learned set state. "TPM active" is displayed on the Control Display.

One wheel is yellow

Flat tire or a major drop in inflation pressure in the indicated tire. A message appears on the Control Display.

All wheels are yellow

Flat tire or a major drop in inflation pressure in several tires. A message appears on the Control Display.

Gray

The system cannot detect a flat tire.

Reasons for this can be:

- ▷ TPM is being reset
- ▷ Temporary interference due to systems or devices which use the same radio frequency
- ▷ Malfunction

Resetting system

 Reset the system again after each correction of the tire inflation pressure and after every tire or wheel change. ◀

Resetting finishes during driving, which can be interrupted at any time. When driving resumes, resetting is continued automatically.

iDrive, for explanation of principle, refer to page 16.

1. Press the **MENU** button.
This opens the start menu.
2. Press the controller to open the **i** menu.
3. Select "Settings" and press the controller.
4. Select "Vehicle / Tires" and press the controller.
5. Change to upper field if necessary. Turn the controller until "TPM" is selected and press the controller.

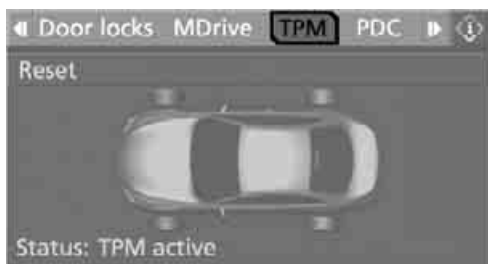

6. Start the engine, but do not start driving.

7. Select "Reset" and press the controller.
8. Select "Yes" and press the controller.



9. Start to drive.
The tires are shown in gray and "Resetting TPM..." is displayed.

After a few minutes of driving, the set tire inflation pressures in the tires are applied as the set values to be monitored. Resetting finishes during driving. The tires are shown in green on the Control Display.

 If a flat tire is detected during resetting and applying the tire inflation pressures, all tires are shown in yellow on the Control Display. The message "Tire low!" is displayed. ◀

Message with low tire inflation pressure

 The warning lamp lights up yellow. A message appears on the Control Display. In addition, an acoustic signal sounds. There is a flat tire or extensive inflation pressure loss.

1. Reduce speed and stop the vehicle carefully. Avoid sudden braking and steering maneuvers.
2. If all four wheels are shown in yellow, identify the damaged tire on the vehicle.
3. Repairing flat tire with M Mobility System, refer to page 212, or replace the damaged wheel or wheels, refer to Changing wheels* on page 215.

The spare tire* is equipped with the necessary TPC electronics and is also monitored after mounting and after resetting the system.

Have the tire replaced by a BMW center or a workshop informed on handling TPM which works according to BMW repair procedures with correspondingly trained personnel.

Malfunction



The yellow warning lamp flashes and then lights up continuously. The tires are shown in gray on the Control Display and a message is displayed. No flat tire can be detected.

A message like this is displayed in the following situations:

- ▶ In case of a malfunction; have the system checked.
- ▶ If a wheels is mounted without TPM electronics.
- ▶ If TPM is temporarily interfered with by other systems or devices which use the same radio frequency.

Declaration according to NHTSA/ FMVSS 138 Tire Pressure Monitoring Systems

Each tire, including the spare*, should be checked monthly when cold and inflated to the inflation pressure recommended by the vehicle manufacturer on the vehicle placard or tire inflation pressure label. If your vehicle has tires of a different size than the size indicated on the vehicle placard or tire inflation pressure label, you should determine the proper tire inflation pressure for those tires. As an added safety feature, your vehicle has been equipped with a tire pressure monitoring system, TPMS, that illuminates a low tire pressure indicator when one or more of your tires are significantly under-inflated. Accordingly, when the low tire pressure indicator illuminates, you should stop and check your tires as soon as possible, and inflate them to the proper pressure. Driving on a significantly under-inflated tire causes the tire to overheat and can lead to tire failure. Under-inflation also reduces fuel efficiency and tire tread life, and may affect the vehicle's handling and stopping ability. Please note that the TPMS is not a substitute for proper tire maintenance,

and it is the driver's responsibility to maintain correct tire pressure, even if under-inflation has not reached the level to trigger illumination of the TPMS low tire pressure indicator.

The TPMS malfunction indicator is combined with the low tire pressure indicator. When the system detects a malfunction, the indicator will flash for approximately one minute and then remain continuously illuminated. This sequence will continue upon subsequent vehicle startups as long as the malfunction exists. When the malfunction indicator is illuminated, the system may not be able to detect or signal low tire pressure as intended. TPMS malfunctions may occur for a variety of reasons, including the installation of replacement or alternate tires or wheels on the vehicle that prevent the TPMS from functioning properly. Always check the TPMS malfunction indicator after replacing one or more tires or wheels on your vehicle to ensure that the replacement or alternate tires and wheels allow the TPMS to continue to function properly.

Brake force display



- ▶ On the left: normal braking.
- ▶ On the right: heavy braking.

Airbags



The following airbags are located under the marked covers:

- 1 Front airbags
- 2 Coupe: head airbags
- 3 Side airbags
- 4 Knee airbag
- 5 Knee airbag

Protective action

⚠ To ensure that the safety systems continue to provide optimized protection, please follow the adjustment instructions on page 46. ◀

The front airbags help protect the driver and front passenger by responding to frontal impacts in which safety belts alone cannot provide adequate restraint. When needed, the head and side airbags help provide protection in the event of a side impact. The relevant side airbag supports the side upper body area. The head airbag supports the head. The knee airbag protects the legs from colliding with the cockpit.

The airbags are deliberately not triggered in every impact situation, e.g. less severe accidents or rear-end collisions.

⚠ Do not apply adhesive materials to the cover panels of the airbags, cover them or modify them in any other way. Do not attempt to remove the airbag restraint system from the vehicle. Do not modify or tamper with either the wiring or the individual components in the airbag system. This category includes the upholstery in the center of the steering wheel, on the instrument panel, the side trim panels on the doors and on the Coupe, the roof pillars along

with the sides of the headliner. Do not attempt to remove or dismantle the steering wheel. Do not touch the individual components directly after the system has been triggered, because there is a danger of burns. In the event of malfunctions, deactivation, or triggering of the airbag restraint system, have the testing, repair, removal, and disposal of airbag generators carried out only by a BMW center or a workshop that works according to BMW repair procedures with appropriately trained personnel and has the required explosives licenses. Otherwise unprofessional attempts to service the system could lead to failure in an emergency or undesired airbag triggering, either of which could result in personal injury. ◀

Warnings and information on the airbags is also provided on the sun visors.

Automatic deactivation of front passenger airbags

The occupation of the seat is detected by evaluating the impression on the occupied seat surface of the front passenger seat. The system correspondingly activates or deactivates the front, knee and side airbags on the front passenger side.

▶ The current status of the front passenger airbags, i.e. deactivated or activated, is indicated by the indicator lamp over the interior rearview mirror, refer to Operating state of front passenger airbags below. ◀

⚠ Before transporting a child in the front passenger seat, read the safety information and follow the instructions under Transporting children safely, refer to page 56.

The front, knee and side airbags on the front passenger side can be deactivated for teenagers and adults in certain sitting positions; the indicator lamp for the front passenger airbags lights up when this occurs. In these cases, change the sitting position so that the front passenger airbags are activated and the indicator lamp goes out. If the desired status cannot be produced by changing the sitting position, transport the corresponding person in the rear seat.

Do not fit seat covers, seat cushion padding, beaded mats or other items onto the front passenger seat unless they are specifically recommended by BMW. Do not place objects under the seat which could press against the seat from below. Otherwise, a correct evaluation of the occupied seat surface cannot be ensured. ◀

Operating state of front passenger airbags



The illustration here shows a possible arrangement in the Coupe. With some vehicle equipment packages or in the Convertible, the arrangement of the switches and indicator lamps may differ somewhat.

The indicator lamp for the front passenger airbags indicates the operating status of the front, knee and side airbags on the front passenger side depending on whether the seat is occupied. The indicator lamp shows whether the front passenger airbags are activated or deactivated.

- ▷ The indicator lamp lights up when a child in a child restraint system intended for the purpose is properly detected on the seat. The front, knee and side airbags on the front passenger side are deactivated.

▷ Most child seats are detected by the system. Especially the child seats required by the NHTSA at the time the vehicle is manufactured. After installing a child seat, make sure that the indicator lamp for the front passenger airbags lights up. This indicates that the child seat has been detected and the front passenger airbags are not activated. ◀

- ▷ The indicator lamp does not light up when, for example, a correctly seated person of sufficient height is detected on the seat. The front, knee and side airbags on the front passenger side are activated.
- ▷ The indicator lamp does not light up when the seat is empty. But the front, knee and side airbags on the front passenger side are still deactivated.

Operational readiness of airbag system



From radio readiness, refer to page 58, the warning lamp lights up briefly, indicating the operational readiness of the entire airbag system and the safety belt tensioners.

Airbag system malfunction

- ▷ Warning lamp does not light up as of radio readiness.
 - ▷ Warning lamp lights up continuously.
- ⚠ Have the airbag system checked immediately in case of a malfunction; otherwise, there is a danger that the airbag system may not respond in the expected manner in an accident despite an impact of corresponding intensity. ◀

Convertible: rollover protection system

The rollover protection system is automatically activated in the event of an accident or a critical driving situation, extreme inclination on the longitudinal axis, or loss of ground contact. The rollover bars located behind the rear head restraints are deployed within fractions of a second.

As a supplement to the rollover bar integrated into the windshield frame, the rollover protection system ensures that all vehicle occupants have the necessary headroom.

 Always keep the path of movement of the rollover protection system clear.

In less severe accidents, you are protected by the fastened safety belt and, depending on the severity of the accident, the belt tensioner and the multistage airbag restraint system. ◀

Lowering

If the rollover protection system experienced no impact after automatic activation, then it can be lowered again. No tools are necessary for this purpose.

1. Press the release backward and hold in that position.



2. Press the rollover protection unit halfway down from above.
3. Let go of the release.

4. Press the rollover protection unit down until it snaps into place.



5. Use the same procedure for the second rollover protection unit.

Have the rollover protection system checked after unexpected triggering.

 Never move the convertible top when the rollover protection system is raised.

No changes of any nature may be made to the individual components of the rollover protection system and wiring.

Work on the rollover protection system may only be performed at a BMW center.

Unprofessional attempts to service the system can lead to failure or malfunction.

For a system check and to ensure long-term functioning, you must comply with the maintenance intervals of the service requirements, refer to page 71. ◀

Head-Up Display*

The concept

With the Head-Up Display, important information is projected into the driver's field of view, e.g. navigation instructions. This enables you to absorb this information without looking away from the road.

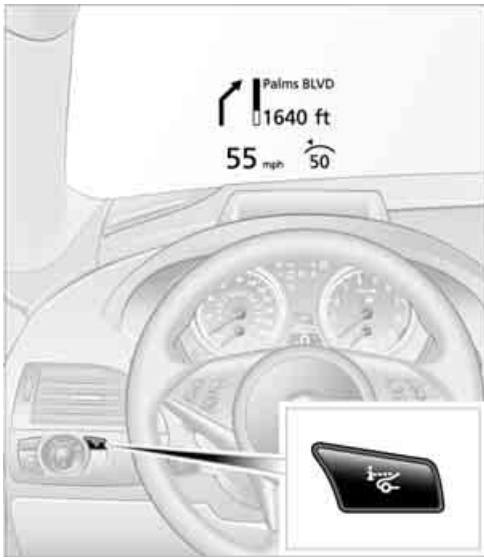

Switching on/off

Press the button.

Selecting displays

iDrive, for explanation of principle, refer to page 16.

1. Press the **MENU** button.
This opens the start menu.
2. Press the controller to open the **i** menu.
3. Select "Settings" and press the controller.
4. Select "Display settings" and press the controller.
5. Change to upper field if necessary. Turn the controller until "Head-Up Display" is selected and press the controller.
6. Change into the second field from the top. Turn the controller until "Head-Up Display" is selected and press the controller.

7. Select desired information of Head-Up Display.

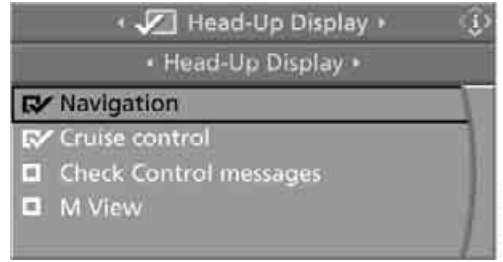

8. Press the controller.
 - The information is shown on the Head-Up Display.
 - "M View": the M view is shown in the Head-Up Display. Information unavailable in the M view appears on the Control Display in gray and cannot be selected.
 - "M View": the default view is displayed.

The M view for the Head-Up Display can also be selected with the  button on the steering wheel, refer to MDrive on page 54.

The settings are stored for the remote key currently in use.

Default view



- 1 Navigation instructions
- 2 Stored desired speed of cruise control
- 3 Speed

M view

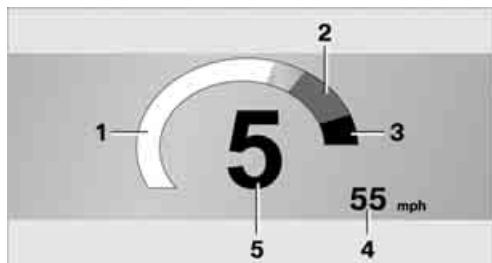

- 1 Current engine speed, highlighted
- 2 Advance warning field of tachometer
- 3 Red warning field of tachometer, also refer to Tachometer on page 68
- 4 Speed
- 5 Gear display

For information on the shift lights in the tachometer, refer to page 63.

Setting brightness

The brightness of the display is automatically adapted to the ambient lighting conditions. However, you can change the base setting. With the low beams switched on, the brightness can also be adjusted with the knurled wheel of the instrument lighting.

iDrive, for explanation of principle, refer to page 16.

1. Press the **MENU** button.
This opens the start menu.
2. Press the controller to open the **i** menu.
3. Select "Settings" and press the controller.
4. Select "Display settings" and press the controller.
5. Change to upper field if necessary. Turn the controller until "Head-Up Display" is selected and press the controller.

6. Change into the second field from the top. Turn the controller until "Brightness" is selected and press the controller.



7. Turn the controller until the desired setting is selected.

The setting is stored for the remote control currently in use.

Notes

The visibility of the displays in the Head-Up Display is influenced by:

- ▷ Sunglasses with certain polarization filters
- ▷ Certain sitting positions
- ▷ Objects on the cover of the Head-Up Display
- ▷ Wet road surface and unfavorable lighting conditions

If the image is distorted, please have the base setting checked at a BMW center.

Specialized windshield

The windshield is a part of the system. The shape of the windshield complies with the requirements of the Head-Up Display to enable a precise display. A film in the windshield prevents double images from being displayed. Windshield replacement should be carried out by a BMW center or a workshop that works according to BMW repair procedures with correspondingly trained personnel.

Care instructions

You can find everything you need to know on this topic by consulting the Caring for your vehicle brochure.

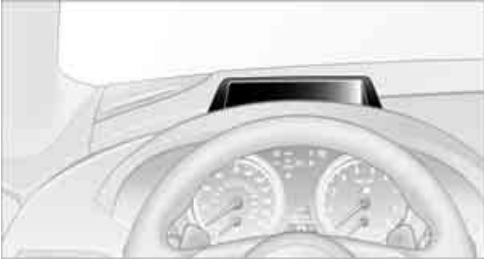

 Only clean the cover of the Head-Up Display with a soft, lint-free cloth or with a display cleaning cloth, otherwise damage may result. ◀

Lamps

Parking lamps/low beams

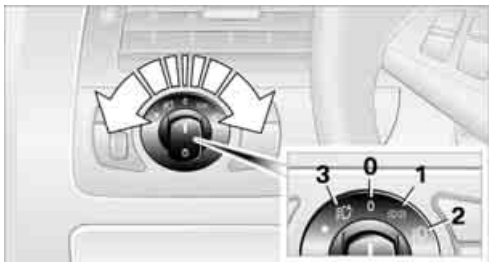

- 0 Lights off and daytime running lamps*
- 1 Parking lamps and daytime running lamps*
- 2 Low beams
- 3 Automatic headlamp control, daytime running lamps* and Adaptive Head Light*

Parking lamps

In switch position **1**, the front, rear and side vehicle lighting is switched on. You can use the parking lamps for parking.

 The parking lamps drain the battery. Do not leave them switched on for long periods of time, otherwise it may no longer be possible to start the engine. It is preferable to switch on the roadside parking lamps on one side, refer to page 97. ◀

Low beams

The low beams light up when the light switch is in position **2** and the ignition is on.

If the light switch remains in position **2**, the exterior lamps are switched off automatically when the driver's door is opened while the ignition is off.

Switch on the parking lamps if required as described under Parking lamps.

Automatic headlamp control

In switch position **3**, the system activates the low beams and switches them on or off in response to changes in ambient light conditions, for instance, in a tunnel, at dawn and dusk and in case of precipitation. Adaptive Head Light* is active. The LED next to the symbol is illuminated when the low beams are on.

A blue sky with the sun low on the horizon can cause the lights to be switched on.

If desired, the light switch can be left in position **3**. The exterior lighting is automatically switched off after switching off the vehicle.



The automatic headlamp control cannot serve as a substitute for your personal judgment in determining when the lamps should be switched on in response to ambient lighting conditions. For example, the sensors cannot detect fog or hazy weather. To avoid safety risks, you should always switch on the low beams manually under these conditions. ◀

Pathway lighting

When you activate the headlamp flasher after parking the vehicle and switching off the lamps, the low beams will come on for a brief period. You can set the duration or deactivate the function via iDrive.

iDrive, for explanation of principle, refer to page 16.

1. Press the **MENU** button. This opens the start menu.
2. Press the controller to open the **i** menu.
3. Select "Settings" and press the controller.
4. Select "Vehicle / Tires" and press the controller.

5. Change to upper field if necessary. Turn the controller until "Lighting" is selected and press the controller.



6. Select "Pathway lighting" and press the controller.
7. Turn the controller to select the desired duration.
8. Press the controller to apply the setting. The setting is stored for the remote control currently in use.

Daytime running lamps*

If desired, the light switch can remain in positions **0**, **1** or **3**.

In positions **0** and **3** the exterior lighting is automatically switched off after the vehicle is switched off. In position **1** the parking lamps light up after the ignition is switched off.

Switch on the parking lamps if required as described under Parking lamps.

Activating/deactivating daytime running lamps*

1. Open the start menu.
2. Press the controller to open the **i** menu.
3. Select "Settings" and press the controller.
4. Select "Vehicle / Tires" and press the controller.

5. Change to upper field if necessary. Turn the controller until "Lighting" is selected and press the controller.



6. Select "Daytime running lamps" and press the controller.
 - The daytime running lamps are switched on.

The setting is stored for the remote control currently in use.

Adaptive Head Light*

The concept

Adaptive Head Light is a variable headlamp control system that enables better illumination of the road surface. Depending on the steering angle and other parameters, the light from the headlamp follows the course of the road.

Activating Adaptive Head Light

In switch position **3**, the Adaptive Head Light is active and the automatic headlamp control is switched on, refer to page [95](#).

To avoid blinding oncoming traffic, the Adaptive Head Light is not active when driving in reverse and points toward the passenger side when the vehicle is stopped.

Malfunction

The LED next to the symbol for automatic headlamp control flashes. The Adaptive Head Light is malfunctioning or has failed. Have the system checked as soon as possible.

High beams/ roadside parking lamps

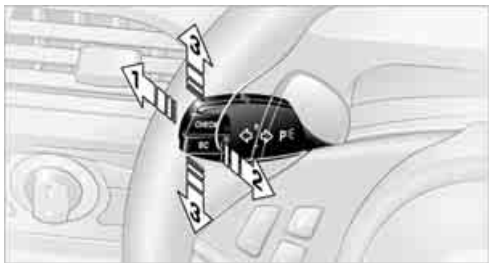

- 1 High beams
- 2 Headlamp flasher
- 3 Roadside parking lamps

Roadside parking lamps, left or right*

You also enjoy the option of lighting up just one side of your vehicle when parking:

Switching on

After parking the vehicle, press the lever up or down beyond the resistance point, arrow **3**.

 The roadside parking lamps drain the battery. Do not leave them switched on for long periods of time, otherwise it may no longer be possible to start the engine. ◀

Switching off

Briefly press the lever in the opposite direction up to the resistance point, arrow **3**.

Instrument lighting



The lighting intensity can be adjusted with the knurled wheel with the parking lamps/low beams switched on.

Interior lamps

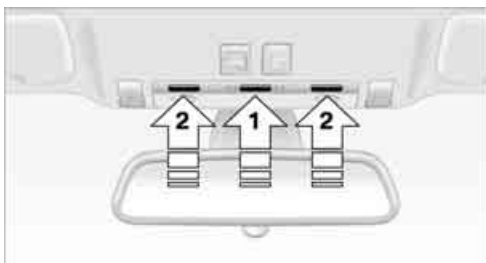

Control of the interior lamps, footwell lamps, door entry lighting, courtesy lamps and sill panel lighting is automatic.

With the courtesy lamps, LED lights are located in the door handles to illuminate the exterior area before the doors.

 To protect the battery, all lamps in the vehicle are switched off approx. 15 minutes after radio readiness is switched off, refer to Start/Stop button on page [58](#). ◀

Switching interior lamps on and off manually

Press button **1**.

If the interior lamps, footwell lamps, door entry lighting, courtesy lamps and sill panel lighting are to remain switched off continually, press the button for approx. 3 seconds.

Reading lamps

The reading lamps are beside the interior lamp:
You can turn them on and off using buttons **2**
located next to the lamps.

Automatic climate control

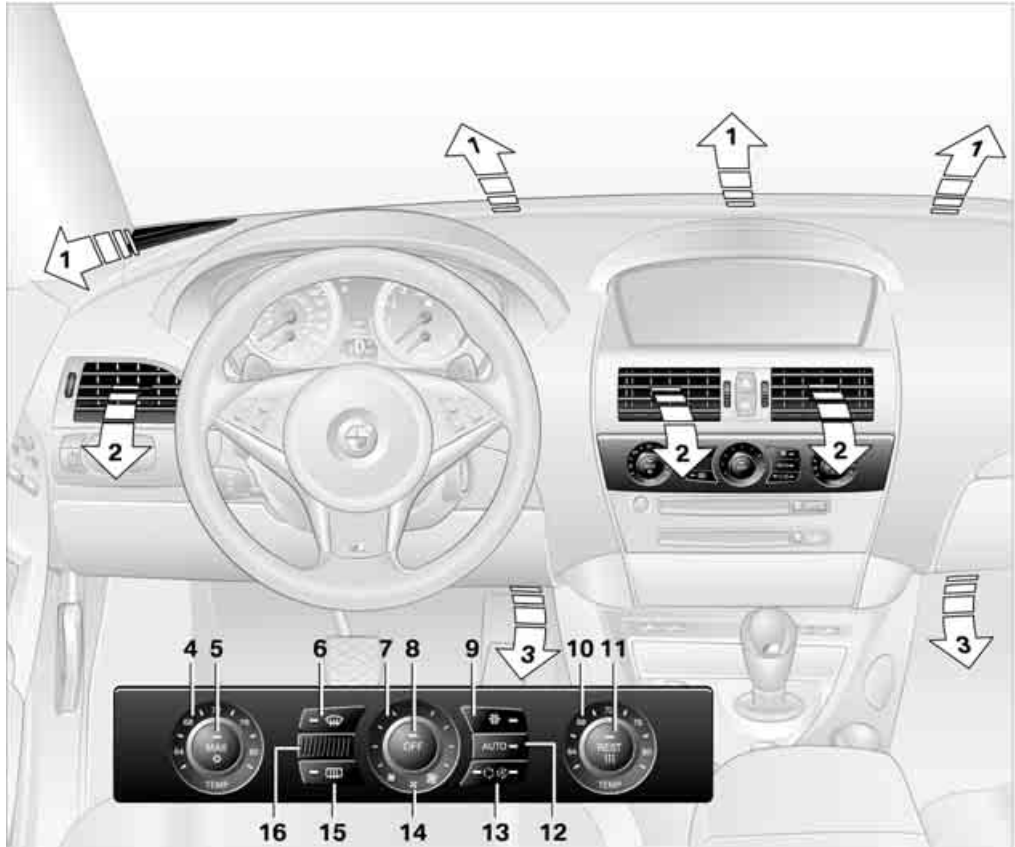

- 1 Air directed toward the windshield and side windows
- 2 Air for the upper body area, refer to Ventilation on page 102
- 3 Air to footwell
- 4 Temperature, left side of passenger compartment
- 5 Maximum cooling
- 6 Defrosting windows and removing condensation
- 7 Air volume, manual
- 8 Switching off automatic climate control
- 9 Switching cooling function on and off manually
- 10 Temperature, right side of passenger compartment
- 11 Residual heat mode
- 12 AUTO program
- 13 AUC automatic recirculated-air control/ recirculated air mode
- 14 LED for parked car ventilation
- 15 Rear window defroster
- 16 Air grill for interior temperature sensor – please keep clear and unobstructed

The current setting for air distribution is displayed on the Control Display.

A congenial climate

The AUTO program offers the optimum air distribution and air volume for virtually all conditions, refer to AUTO program below. Now you only need to select an interior temperature that you find pleasant.

The following sections contain more detailed information on the available setting options.

Most settings are stored for the remote control currently in use, also refer to Personal Profile settings on page 29.

AUTO program

 The AUTO program handles the adjustment of air volume and air distribution to the windshield and side windows, in the direction of the upper body and in the footwell. It also adapts your instructions for the temperature to outside influences throughout the year.

The cooling is switched on automatically with the AUTO program. At the same time, a condensation sensor controls the program in such a way that window condensation is prevented as much as possible.

Intensity of AUTO program

To meet your individual needs, you can increase or decrease the intensity of the automatic climate control.

iDrive, for explanation of principle, refer to page 16.

1. Press the **MENU** button.
This opens the start menu.
2. Move the controller to the left to open "Climate".
3. Select "Automatic programs" and press the controller.

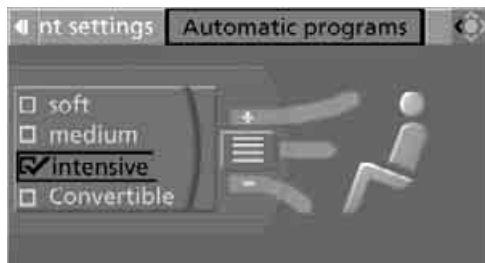

4. Select the desired intensity and press the controller.

The marked intensity of the automatic program is switched on.

Convertible program*

When the convertible top is opened, the convertible program can also be selected. In the convertible program, the automatic climate control is optimized for driving with the convertible top open. In addition, the air volume is increased as the speed increases.

If the convertible program has been selected, it is automatically active every time the top is opened.

 The effect of the convertible program can be greatly enhanced if the wind deflector is installed. ◀

Temperature



Set the desired temperature individually on the driver's and front passenger side.

The automatic climate control achieves this temperature as quickly as possible at any time of year, if necessary with the maximum cooling or heating capacity, and then keeps it constant.

 When switching between different temperature settings in rapid succession, the automatic climate control does not have sufficient time to achieve the set temperature. ◀

In the highest setting you activate the maximum heating output, regardless of the outside temperature.

Adapting temperature in upper body region

1. Open the start menu.
2. Open "Climate".
3. Select "Vent settings" and press the controller.
4. Select the field by moving the controller and adjust the temperature by turning the controller.



Defrosting windows and removing condensation



Quickly remove ice and condensation from the windshield and front side windows.

To do this, also switch on the cooling function.

Rear window defroster



The rear window defroster switches off automatically after a certain amount of time.

Convertible: the rear window defroster is only activated when the rear window is closed. Depending on the vehicle equipment, upper wires are used as an antenna and are not part of the rear window defroster.

Air volume, manual



You can adjust the air volume by turning. You can reactivate the automatic mode for the air volume with the AUTO button.

Manual air distribution

1. Open the start menu.
2. Open "Climate".

3. Select "Vent settings" and press the controller. The driver's and front passenger side can be adjusted separately with the fields on the right or left side.
4. Select the driver's or front passenger side if necessary. Move the controller to the right or left repeatedly until the driver's side or front passenger side is selected.
5. Select the desired field by moving the controller.
6. Turn the controller to adjust the air distribution.



Driver's side:

- 1 Air directed toward the windshield and side windows
- 2 Air for the upper body
- 3 Air to footwell

Front passenger side:

- 4 Air for the upper body
- 5 Air to footwell



Pressing the AUTO button cancels the air distribution settings via iDrive and vice versa. ◀

Switching cooling function on and off



The cooling function cools and dehumidifies the incoming air before reheating it as needed according to the temperature setting. Depending on the weather, the windshield may fog over briefly when the engine is started.

The cooling function is switched on automatically with the AUTO program. The passenger

compartment can only be cooled with the engine running.

Maximum cooling



Maximally cooled air is obtained as quickly as possible from an outside temperature above approx. 32 °F / 0 °C and with the engine running.

The automatic climate control changes over to the lowest temperature and switches into the recirculated-air mode. The maximum air volume only flows out of the vents for the upper body. It is therefore necessary for these vents to be open for maximum cooling.

AUC Automatic recirculated-air control/recirculated-air mode



You can respond to unpleasant odors or pollutants in the immediate environment by temporarily suspending the supply of outside air. The system then recirculates the air currently within the vehicle. In AUC mode, a sensor detects pollutants in the outside air and controls the shut-off automatically.

Press the button repeatedly to run through the following control sequence:

- ▷ LED off: outside air flows into the vehicle continuously.
- ▷ Right LED on, AUC mode: the system detects pollutants in the outside air and responds by blocking the supply of outside air when required.
- ▷ Left LED on, recirculated-air mode: the supply of outside air into the vehicle is shut off continuously.

 If condensation starts to form on the inside window surfaces during operation in the recirculated-air mode, you should switch it off while also increasing the air volume as required.

The recirculated-air mode should not be used over a longer period of time, as the air quality inside the vehicle deteriorates continuously. ◀

Residual heat



The heat stored in the engine is used to heat the passenger compartment, e.g. while stopped at a school to pick up a child.

The function can be switched on when the following conditions are met:

- ▷ up to 15 minutes after switching off the engine
- ▷ engine at operating temperature
- ▷ sufficient battery voltage
- ▷ outside temperature below 77 °F / 25 °C

The LED lights up when the function is switched on.

With the ignition lock at radio readiness or higher the interior temperature, the air volume and the air distribution can be set.

Switching automatic climate control on and off



The air volume, the heater and the cooling function are all switched off.

You can restart the automatic climate control by pressing any of its buttons except the REST button.

Ventilation

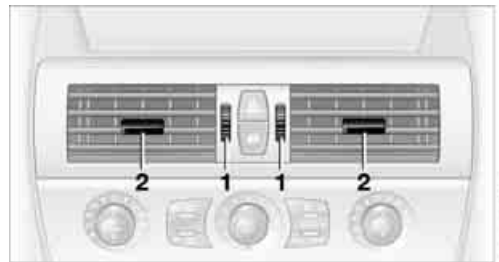

- 1 Knurled wheels for smoothly opening and closing vent outlets
- 2 Levers for changing the airflow direction

 Do not drop any foreign objects into the vent outlets; otherwise, they could be catapulted outwards and cause injuries. ◀

Ventilation for cooling

Adjust the vent outlets to direct the flow of cool air in your direction, for instance, if the interior has become too warm, etc.

Draft-free ventilation

Set the vent outlets so that the air flows past you and is not directed straight at you.

Microfilter/activated-charcoal filter

The microfilter removes dust and pollen from the incoming air. The activated-charcoal filter provides additional protection by filtering gaseous pollutants from the outside air. Your BMW center replaces this combined filter as a standard part of your scheduled maintenance. You can have more detailed information shown on the Control Display, refer to page 71.

Parked car ventilation

The concept

The parked car ventilation blows air into the passenger compartment to lower interior temperatures.

It is ready to use in the parked-car mode at any outside temperature.

You can set two different times for the system to start. The parked car ventilation can also be switched on and off directly. It remains switched on for 30 minutes.

Since the system uses a substantial amount of electrical current, you should refrain from activating it twice in succession without allowing the battery to be recharged in normal operation between uses.

The air emerges through the upper body region vent outlets in the instrument panel. Therefore, please open the vent outlets.

The parked car ventilation system is operated via iDrive.

Switching on and off directly

iDrive, for explanation of principle, refer to page 16.

1. Open the start menu.
2. Move the controller to the left to open "Climate".
3. Select "Parked car operation" and press the controller.
4. Select "Automatic ventilation" and press the controller.
5. Select "Parked car ventilation" and press the controller.

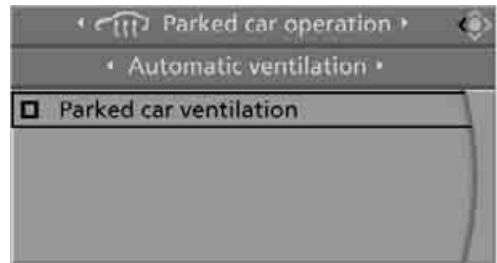

The parked car ventilation is switched on. The  symbol on the display of the automatic climate control flashes.

Preselecting activation times

1. Open the start menu.
2. Move the controller to the left to open "Climate".
3. Select "Parked car operation" and press the controller.
4. Select "Activation time" and press the controller.
5. Move the controller to the left or right to select "Timer 1" or "Timer 2".

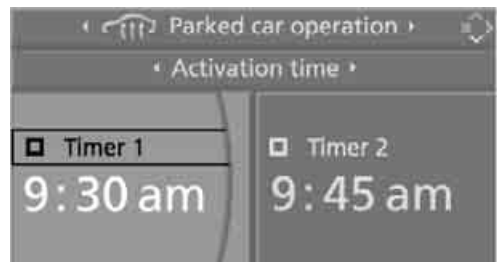

- Select the time and press the controller.
The first time setting is selected.

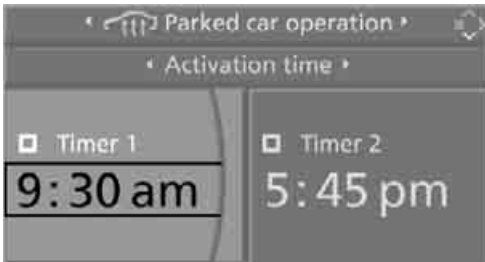

- Turn the controller to make the adjustment.
- Press the controller to apply the setting.
The next adjustment is selected.
- Make the remaining adjustments. After the last adjustment, the time is stored.

Activating timer

Move the controller to the left or right to select "Timer 1" or "Timer 2" and then press the controller.

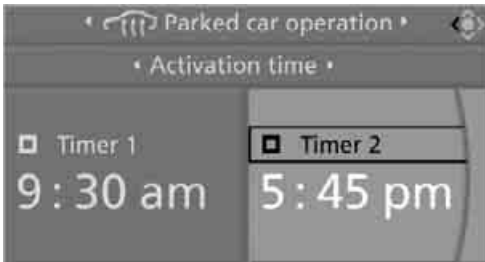

- The switch-on time is activated.

The ☸ symbol on the display of the automatic climate control lights up.

The ☸ symbol on the display of the automatic climate control flashes when the parked car ventilation has switched on.

- The parked car ventilation is only available for activation within the subsequent 24 hours. After that, the time must be reactivated. ◀

Practical interior accessories

Integrated universal remote control*

The concept

The integrated universal remote control can replace as many as three hand-held transmitters for various remote-controlled accessories, such as garage and gate or lighting systems. The integrated universal remote control registers and stores signals from the original hand-held transmitters.

The signal of an original hand-held transmitter can be programmed on one of the three memory buttons **1**. After this, the programmed memory button **1** will operate the system in question. The LED **2** flashes to confirm transmission of the signal.

If you sell your vehicle one day, delete the saved programs beforehand for your own security, refer to page **106**.

 To prevent possible damage or injury, before programming or using the integrated universal remote control, always inspect the immediate area to make certain that no people, animals or objects are within the travel range of the device. Also, comply with the safety precautions of the original hand-held transmitter. ◀

Checking compatibility

 If you see this symbol on the packaging or in the manual supplied with the original hand-held transmitter, it is safe to assume that it is compatible with the integrated universal remote control.

 If you have additional questions, please contact your BMW center or call: 1-800-355-3515.

Information is also provided on the Internet at: www.bmwusa.com or www.homelink.com.

HomeLink is a registered trademark of Johnson Controls, Inc. ◀

Programming

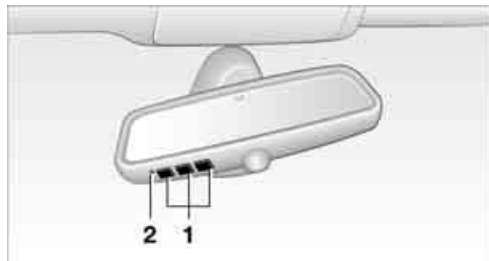

- 1 Memory buttons
- 2 LED

Fixed-code hand-held transmitters

1. Switch on ignition, refer to page **58**.
2. When using for the first time: press the left and right-hand memory button **1** for approx. 20 seconds until the LED **2** flashes quickly. All stored programs are deleted.
3. Hold the original hand-held transmitter at a distance of approx. 4 in/10 cm to 12 in/30 cm from the memory buttons **1**.

 The required distance between the hand-held transmitter and the memory buttons **1** depends on the particular system of the original hand-held transmitter used. ◀

4. Simultaneously press the transmit key on the original hand-held transmitter and the desired memory button **1** on the integrated universal remote control. The LED **2** flashes slowly at first. As soon as the LED **2** flashes rapidly, release both buttons. If the LED **2** does not flash rapidly after approx. 15 seconds, alter the distance and repeat the step.
5. To program other original hand-held transmitters, repeat steps 3 and 4.

The corresponding memory button **1** is now programmed with the signal of the original hand-held transmitter.

You can operate the device when the engine is running or when the ignition is switched on.

▶ If the device fails to function even after repeated programming, check whether the original hand-held transmitter uses an alternating-code system. To do so, either read the instructions for the original hand-held transmitter or hold down the programmed memory button **1** of the integrated universal remote control. If the LED **2** on the integrated universal remote control flashes rapidly for a short time and then remains lit for approx. 2 seconds, this indicates that the original hand-held transmitter uses an alternating-code system. In the case of an alternating-code system, program the memory buttons **1** as described at Alternating-code hand-held transmitters. ◀

Alternating-code hand-held transmitters

To program the integrated universal remote control, consult the operating instructions for the equipment to be set. You will find information there on the possibilities for synchronization.

When programming hand-held transmitters that employ an alternating code, please observe the following supplementary instructions:

▶ Programming will be easier with the aid of a second person. ◀

1. Park your vehicle within the range of the remote-controlled equipment.
2. Program the integrated universal remote control as described above in Fixed-code hand-held transmitters.
3. Locate the button on the receiver of the device to be set, e.g. on the drive unit.
4. Press the button on the receiver of the equipment to be set. After step 4, you have approx. 30 seconds for step 5.
5. Press the programmed memory button **1** of the integrated universal remote control three times.

The corresponding memory button **1** is now programmed with the signal of the original hand-held transmitter.

▶ If you have any additional questions, please contact your BMW center. ◀

Deleting stored programs

Press the left and right-hand memory button **1** for approx. 20 seconds until the LED **2** flashes. All stored programs are deleted.

Programs cannot be deleted individually.

Glove compartment

Opening

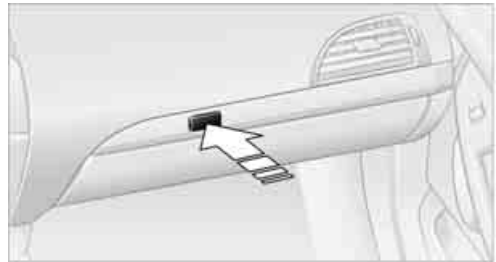

Press the button. The glove compartment opens automatically and the lamps come on.

⚠ To prevent injury in the event of an accident while the vehicle is being driven, close the glove compartment immediately after use. ◀

Closing

Fold the cover up.

Rechargeable flashlight*

The flashlight is located on the left side of the glove compartment.

The flashlight can remain there continuously. Remove the flashlight from the socket when needed.

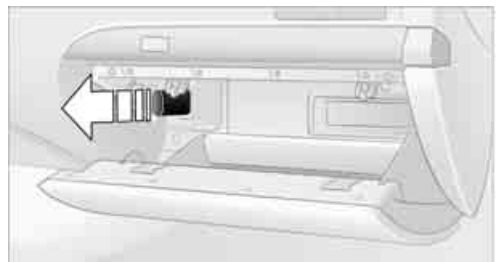

 Be sure that the flashlight is switched off when it is inserted into its socket. Failure to comply with this precaution could lead to overcharging and damage. ◀

Center armrest



A storage compartment is located in the armrest between the front seats. This compartment is integrated into the central locking system and can also be locked separately using the hotel function, refer to page 33.

To open the cover:

Pull the left button. The cover opens and can be folded upward.

Depending on the version, the storage compartment can be equipped with a corresponding cradle* for the telephone or mobile phone.

Connection for external audio device

A connection for an external audio device is located in the storage compartment. You can, for example, connect a CD player or an MP3 player, and play the sound via the vehicle loudspeakers, refer to page 167

Adjusting height

The center armrest can be set in two positions.



Pull the right button:

Move the armrest upward or downward and lock it in the desired position.

Storage compartments

Storage compartment behind center armrest

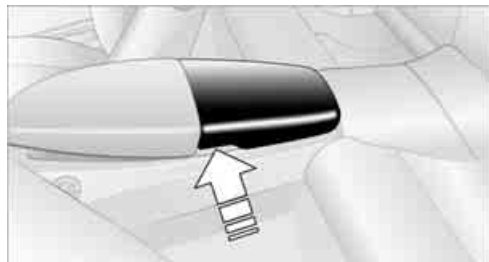

To open, raise the cover at the left or right edge. The compartment contains the cup holder and the lock for the hotel function, refer to page 33.

Other compartments and nets

Other compartments are provided in the doors as well as in the front center console*.

Ticket pockets are located in the sun visors. Storage nets are located on the backrests of the front seats and in the passenger footwell*.

 To prevent the risk of injury during an accident, do not stow hard or sharp-edged items in the nets. ◀

Another storage space is located in the luggage compartment in the right side panel. If you wish, this is also suitable to store the onboard documentation.

Coupe: clothes hooks

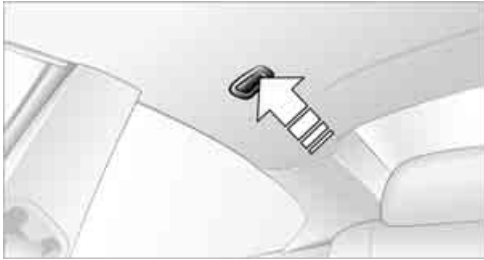

To fold down, press at the top edge.

⚠ When hanging clothing on the hooks, ensure that it will not obstruct the driver's vision. Do not hang heavy objects on the hooks. If you do so, they could cause personal injury to occupants during braking or evasive maneuvers. ◀

Cup holders

⚠ Do not place containers made of glass in the cup holders. This would lead to an increased risk of injury in the event of an accident. Do not force unsuitable containers into the cup holders, as otherwise damage can result. ◀



The compartment of the rear center console contains a built-in cup holder and a removable one.



The removable cup holder can be inserted into the side of the center console.

Ashtray

Opening

Press the trim strip of the cover.

Emptying



Press the opened cover beyond the resistance point, refer to arrow: the ashtray lifts up for removal.

Cigarette lighter



Press in the lighter with the engine running or the ignition switched on.

The lighter can be removed as soon as it pops back out.

 Hold or touch the hot cigarette lighter by the knob only. Holding or touching it in other areas could result in burns. Always take along the remote control when you leave the vehicle; otherwise, children could, for example, use the lighter and burn themselves. ◀

Connecting electrical devices

Socket

With the engine running or the ignition switched on, the cigarette lighter socket can be used as a power outlet for hand flashlights, car vacuum cleaners, etc., with power ratings of up to approx. 200 W at 12 V. Avoid damaging the socket by inserting plugs of different shapes or sizes.

In front passenger footwell



Access to the socket:
Fold open the cover.

Ski bag*

It permits safe and clean transport of up to two pairs of standard skis or one snowboard.

You can use the ski bag to stow skis up to 6.9 ft/ 2.10 m long.

Loading

1. Press the button downward and pull the filler element forward.



2. Extend the ski bag between the front seats. The zipper gives you easy access to stowed items and facilitates drying of the ski bag.
3. Press the button in the luggage compartment.

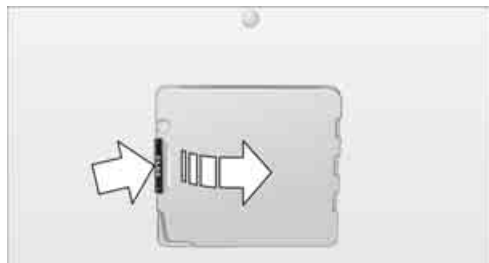

4. Open the loading flap and use the magnetic holder to secure it to the rear panel.

To stow the ski bag, perform the above steps in reverse order.

Only stow clean skis in the ski bag. Wrap sharp edges so that no damage occurs.

Securing cargo

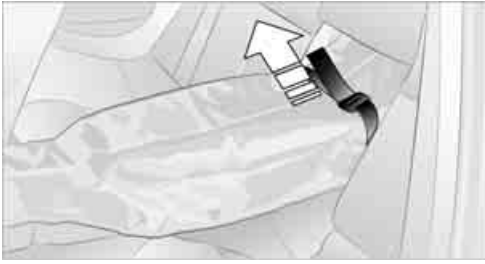

After loading, secure the ski bag and its contents. To do so, tighten the retaining belt at the buckle.

 Secure the ski bag in this way. If you fail to do so, it could move around and endanger occupants during braking or evasive maneuvers.

To refit the filler element, insert the two tabs at the bottom into the strip and press the filler element back into place. Make sure that you do not damage the rear seat upholstery. ◀



Driving tips

This section is designed to provide you with extra support by supplying information useful in dealing with specific driving and operating conditions.

Things to remember when driving

Breaking-in

Moving parts need time to adjust to one another. To ensure that your vehicle continues to provide optimized economy of operation throughout an extended service life, we request that you devote careful attention to the following section.

Do not use the driving programs 5 and 6, refer to Drivelogic on page 62, during break-in.

Engine and differential

Always obey all official speed limits.

Up to 1,200 miles/2,000 km

Drive at changing engine and driving speeds, however do not exceed 5,500 rpm or 105 mph/170 km/h.

Avoid full-throttle operation and use of the transmission's kick-down mode during these initial miles.

From 1,200 miles/2,000 km to 3,000 miles/5,000 km

The engine and driving speeds can gradually be increased up to a continuous vehicle speed of 135 mph/220 km/h. Only drive at top speed briefly, e.g. when passing.

Transmission

The function of the transmission is only at its optimized level after driving a distance of approx. 300 miles/500 km. Do not exceed engine speeds of 5,500 rpm during this time.

Tires

Due to technical factors associated with their manufacture, tires do not achieve their full traction potential until after an initial break-in period. Therefore, drive reservedly during the first 200 miles/300 km.

Brake system

Brakes require an initial break-in period of approx. 300 miles/500 km to achieve optimized contact and wear patterns between brake pads and rotors. Drive in a reserved manner during this break-in period.

Clutch

The function of the clutch is only at its optimized level after a distance driven of approx. 300 miles/500 km. With manual transmission: During this break-in period, engage the clutch gently.

Following part replacement

Observe the break-in instructions again if components mentioned above must be replaced after subsequent driving operation.

General driving notes

Closing luggage compartment lid



Only drive with the luggage compartment lid completely closed, otherwise exhaust can penetrate into the passenger compartment. ◀

If special circumstances should make it absolutely necessary to operate the vehicle with the luggage compartment lid open:

1. Coupe: close both windows.
Convertible: with closed top, close all windows.
2. Increase the air volume of the automatic climate control to a high level, refer to page 101.

Hot exhaust system

 As in all vehicles, extremely high temperatures are generated in the exhaust system. Do not remove the heat shields installed adjacent to it, and never apply undercoating to them. When driving, standing at idle and while parking, take care to avoid possible contact between the hot exhaust system and any highly flammable materials such as hay, leaves, grass, etc. Such contact could lead to a fire, and with it the risk of serious property damage as well as personal injury. Do not touch hot exhaust tail pipes. Otherwise there is a risk of burns. ◀

Mobile communications devices in vehicle

 BMW advises against using mobile communications devices, e.g. mobile phones, inside the vehicle without a direct connection to an external antenna. Otherwise, the vehicle electronics and mobile communications device can interfere with each other. In addition, there is no assurance that the radiation emitted during transmission will be conveyed out of the vehicle interior. ◀

Hydroplaning

 When driving on wet or slushy roads, reduce road speed. If you do not, a wedge of water can form between tires and road surface. This phenomenon is referred to as hydroplaning, and is characterized by a partial or complete loss of contact between the tires and the road surface, ultimately undermining your ability to steer and brake the vehicle. ◀

The risk of hydroplaning increases as the tread depth of the tires decreases, also refer to Minimum tire tread on page 199.

Driving through water

 Do not drive through water on the road if it is deeper than 1 ft/30 cm, and then only at walking speed at the most. Otherwise, the vehicle's engine, the electrical systems and the transmission may be damaged. ◀

Starting off

On slopes

The starting assistant enables starting off on slopes virtually without rolling back.

1. Hold the vehicle with the footbrake.
2. Make sure that the handbrake is released.
3. Release the footbrake and drive off quickly.

 The starting assistant holds the vehicle for approx. 1 second after releasing the footbrake. Depending on the load, the vehicle may also roll back slightly during this time. After releasing the footbrake, drive off quickly, otherwise the starting assistant no longer holds the vehicle after approx. 1 second and it begins to roll back. ◀

 Start off quickly on slopes. Do not hold the vehicle on a hill by pressing the accelerator, but apply the footbrake or handbrake instead. Otherwise, overheating and heavy wear can result in the area of the Sequential Manual Transmission. ◀

To protect the clutch of the Sequential Manual Transmission from overheating, the starting-off behavior is changed under heavy loading, e.g. a rapid succession of starts on slopes. This can be noticed from shaking during starting off.

On a slippery surface

1. Select "P 400" program of M Engine Dynamic Control, refer to page 64.
2. Gently press accelerator pedal to prevent wheels from spinning when starting off.

Clutch protection with manual transmission

Be sure to avoid riding the clutch for longer periods.

Your BMW M6 is equipped with an overload protection for the clutch. Riding the clutch for longer periods is detected and the engine management system limits the engine speed to protect the clutch. This can result in the vehicle failing to accelerate when the clutch pedal is partially depressed.

Braking safely

Your BMW is equipped with ABS as a standard feature. In situations that require it, it is best to brake with full force. Since the vehicle maintains steering responsiveness, you can still avoid possible obstacles with a minimum of steering effort.

The pulsing of the brake pedal indicates that the ABS is controlling braking.

In certain braking situations the perforated brake rotors can cause operating noises which, however, have no effect on the performance and operating safety of the brake system.

 Do not drive with your foot resting on the brake pedal. Even light but consistent pedal pressure can lead to high temperatures, brake wear and possibly even brake failure. ◀

Driving in wet conditions

When driving on wet roads or in heavy rain, it is a good idea to apply light pressure to the brake pedal every few miles. Monitor traffic conditions to ensure that this maneuver does not endanger other road users. The heat generated in this process helps dry the pads and rotors to ensure that full braking efficiency will then be available when you need it.

Hills

 To prevent overheating and thus reduced efficiency of the brake system, downshift to a gear in which only minimal brake applications are needed when descending long or steep downhill stretches. Even light but consistent pressure on the brake pedal can lead to high temperatures, brake wear and possibly even brake failure. ◀

 Sequential Manual Transmission: do not drive in idle or with the engine switched off, otherwise there will be no engine braking action or support of the braking force and steering.

Manual transmission: do not drive with the clutch depressed, in idle or with the engine switched off, otherwise there will be no engine braking action or support of the braking force and steering.

Never allow floor mats, carpets or any other objects to protrude into the area of movement of the pedals and impair their operation. ◀

Corrosion on brake rotors

When the vehicle is driven only occasionally, during extended periods when the vehicle is not used at all, and in operating conditions where brake applications are less frequent, there is an increased tendency for corrosion to form on rotors, while contaminants accumulate on the brake pads. This occurs because the minimum pressure which must be exerted by the pads during brake applications to clean the rotors is not reached.

Should corrosion form on the brake rotors, the brakes will tend to respond with a pulsating effect that even extended application will fail to cure.

When vehicle is parked

Condensation forms in the automatic climate control during operation, and then exits under the vehicle. Traces of condensed water under the vehicle are therefore normal.

Before driving into a car wash

Fold in the exterior mirrors, refer to page 52, otherwise they could be damaged due to the width of the vehicle.

General information on the care and maintenance of your BMW is contained in the Caring for your vehicle brochure.

Ground clearance

 Ensure that sufficient ground clearance is available. To drive down curbs, select the "Sport" program of the EDC Electronic Damping Control, refer to page 84, to keep the ground clearance as uniform as possible. Otherwise, the vehicle may be damaged. ◀

Cargo loading

 To avoid loading the tires beyond their approved carrying capacity, never overload the vehicle. Overloading can lead to overheating and increases the rate at which damage develops inside the tires. The ultimate result can assume the form of a sudden blow-out. ◀

Determining loading limit



1. Locate the following statement on your vehicle's placard*:

 The combined weight of occupants and cargo should never exceed YYY lbs. or XXX kg, as otherwise the vehicle may be damaged and unstable driving conditions may result. ◀

2. Determine the combined weight of the driver and passengers that will be riding in your vehicle.
3. Subtract the combined weight of the driver and passengers from XXX lbs. or YYY kg.
4. The resulting figure equals the available amount of cargo and luggage load capacity. For example, if the XXX amount equals 800 lbs. and there will be four 150-lb. passengers in your vehicle, the amount of available cargo and luggage load capacity is 200 lbs.:
800 lbs. minus 600 lbs. = 200 lbs.
5. Determine the combined weight of luggage and cargo being loaded on the vehicle. That weight may not safely exceed the available cargo and luggage load capacity calculated in step 4.

6. If your vehicle will be towing a trailer, part of the load from your trailer will be transferred to your vehicle. Consult the manual for transporting a trailer to determine how this may reduce the available cargo and luggage load capacity of your vehicle.

Load

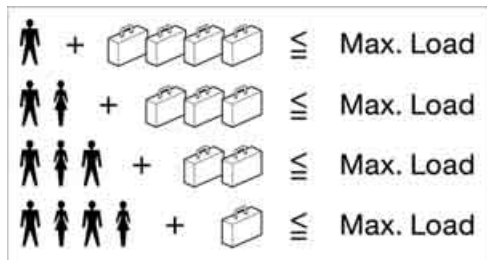

The permissible load is the total of the weight of occupants and cargo/luggage. The greater the weight of occupants, the less cargo/luggage can be transported.

Stowing cargo

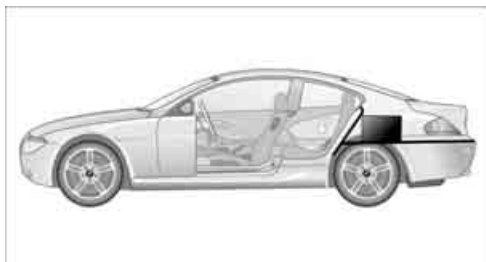

- ▷ Place heavy cargo as far forward and as low as possible, placing it directly behind the bulkhead behind the rear seats.
- ▷ Cover sharp edges and corners.

Securing cargo

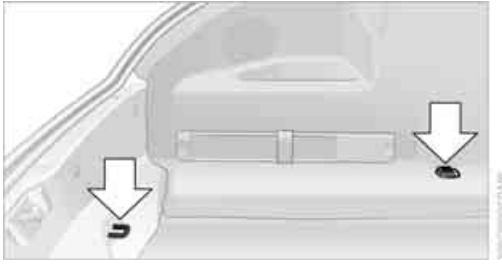

- ▷ Use the luggage net* or securing straps to hold down small and lightweight luggage and cargo.
- ▷ Heavy-duty cargo straps* for securing larger and heavier objects are available at your BMW center. Four lashing eyes mounted in the luggage compartment are used to secure these heavy-duty cargo straps, refer to arrows.
- ▷ Please observe the special instructions supplied with the heavy-duty cargo straps.

 Position and secure the cargo as described above, so that it cannot endanger the vehicle's occupants, for example if sudden braking or evasive maneuvers are necessary.

When fastening lashings, use only the lashing eyes, refer to illustration; otherwise, the lashings could come loose or you could damage the vehicle.

Never exceed the approved gross vehicle weight or either of the approved axle loads, refer to page 228, as excessive loads can pose a safety hazard, and may also put you in violation of freeway safety laws.

You should never transport unsecured heavy or hard objects in the passenger compartment, as they could fly around and pose a safety hazard to the vehicle's occupants during abrupt braking or evasive maneuvers. ◀

Pad on base of luggage compartment

You can use the pad as needed, for example to transport soiled objects. The rubberized side is washable and has an anti-skid effect.



Navigation

This chapter describes how you can enter destinations and specify your route so that your navigation system guides you reliably to your destination.

Starting navigation system*

Your navigation system can use satellites to ascertain the precise position of your vehicle and guide you reliably to any destination you enter.

Navigation DVD

The navigation system requires a special navigation DVD. The latest version is available at your BMW center.

Inserting navigation DVD



1. Insert the navigation DVD with the labeled side up. The navigation DVD is pulled in automatically.
2. Wait several seconds for the system to scan the data from the DVD.

Removing navigation DVD

1. Press **MENU** button 1.
The DVD emerges slightly from the drive.
2. Remove the DVD.

If the DVD is not ejected from the drive, it is possible that it is blocked. In this case a message is also shown on the Control Display.

Display in the assistance window

You can display the route or the current position in the assistance window. This display remains visible even if you change to another application.

1. Move the controller to the right to enter the assistance window.



2. Press the controller.
Other menu items are displayed.
3. Select the desired route view or "Current position".



4. Press the controller.

Displaying arrow view in map view

If the navigation system suggests a change of direction, the arrow view is briefly displayed.

1. Press the **MENU** button.
This opens the start menu.
2. Press the controller to open the **i** menu.
3. Turn the controller until "Settings" is selected and press the controller.

4. Turn the controller until "Language / Units" is selected and press the controller.
5. Change to upper field if necessary. Turn the controller until "Languages" is selected and press the controller.
6. Select "Arrow display pop-up instructions" and press the controller.

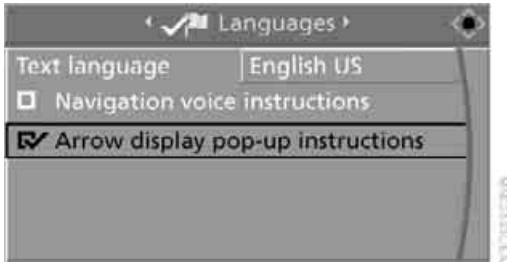

The arrow display is shown.

Destination entry

In entering your destination you can select from among the following options:

- ▷ Entering a destination manually, see below
- ▷ Entering destination via voice*, refer to page 127
- ▷ Selecting destination using information, refer to page 130
- ▷ Selecting destination from a list, refer to Destination list, page 131
- ▷ Selecting destination from address book, refer to page 132
- ▷ Selecting home address, refer to page 134

After selecting your destination you can proceed to start the destination guidance, refer to page 136.

 Enter data only when the vehicle is stationary, and always obey the traffic regulations and road signs in the event of any contradiction between traffic and road conditions and the instructions issued by the navigation system. If you do not observe this precaution, you can endanger the vehicle occupants and other road users. ◀

iDrive, for explanation of principle, refer to page 16.

1. Press the **MENU** button.
This opens the start menu.
2. Move the controller to the right to call up "Navigation".
3. Select "Navigation" and press the controller.

Entering a destination manually

The system's word-matching principle makes it easier for you to enter the names of streets or towns, refer to page 135. This allows you to enter different spellings and completes your entry automatically so that stored names can be called up quickly.

1. Change to upper field if necessary. Turn the controller until "Navigation" is selected and press the controller.
"New destination" is selected.
2. Press the controller.



3. Select "Enter address" and press the controller.



The system also assists you with the following features:

- ▷ If you do not enter a street, the system will guide you to the downtown area of a town or city.
- ▷ You can skip the entry of country and town/city if the current entries are being retained for your new destination.

Selecting country

1. Select "State / Province" or the displayed country and press the controller.



A list of available countries appears on the display.

2. Select the country of destination and press the controller.

In order to be able to start the destination guidance, at least the town/city of destination or its zip code must be entered.

Entering town/city of destination via name

1. Select "Town / City" or the displayed town/city and press the controller.
2. Select the first letter and press the controller.
A list of all towns/cities starting with this letter appears on the Control Display.
3. To delete the letter entered if necessary:

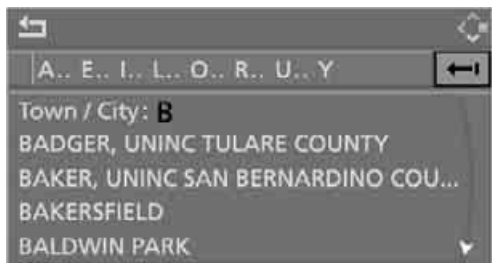

- ▷ Delete individual numbers or letters:
Move the controller toward the right to select ← and press the controller.
- ▷ Delete all digits or letters:
Move the controller toward the right to select ← and press the controller longer.

4. Enter additional letters if necessary.
The list gradually grows smaller each time you enter a new letter.
 - ▷ To enter a blank space if necessary:
Select the _ symbol and press the controller.



5. Change to the third field from the top if necessary. Turn the controller until the town/city name is selected from the list and press the controller.



Entering town/city of destination via zip code

1. Select "Town / City" and press the controller.
2. Enter the zip code:
Select the individual digits and press the controller.

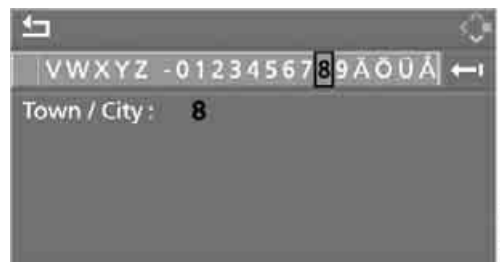

- ▷ Enter a blank space:
Select the _ symbol and press the controller.
 - ▷ Delete individual digits or letters:
Move the controller toward the right to select ←| and press the controller.
 - ▷ Delete all digits or letters:
Move the controller toward the right to select ←| and press the controller longer.
3. Select the zip code and press the controller.
The corresponding town/city of destination is displayed.
 4. Change into the third field from the top.
Turn the controller until the town/city of destination is selected and press the controller.

Entering street, house number and intersection

After the street you can also enter the intersection or the house number.

Entering street and intersection

1. Select "Street" or the displayed street and press the controller.
2. Enter the street.
The street is entered in exactly the same way as the town/city of destination.



The intersection is entered in the same way as the street.

Entering a street without entering town/city of destination

You can also enter a street without entering a town/city of destination. In this case all streets of the entered country are offered for selection. The related town/city is displayed after the street name.

If a town/city has already been entered, you can undo this entry. This may be practical if the desired street does not exist in the entered town/city of destination, because, for example, it belongs to another part of the town/city.

1. Change to upper field.
The ↵ arrow is selected.



2. Turn the controller to the right until the request for the entry of a street in the country appears and press the controller.

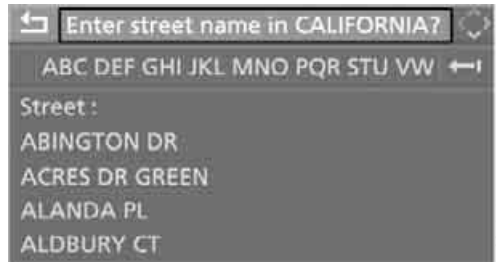

3. Change to the second field from the top and enter the street.

Entering house number

All house numbers stored for the street on the navigation DVD can be entered.

1. Select "House number" and press the controller.
2. Enter the house number:
Select the individual digits and press the controller.
3. Change into the third field from the top.
Turn the controller until the house number is selected and press the controller.

Starting destination guidance with manual destination entry

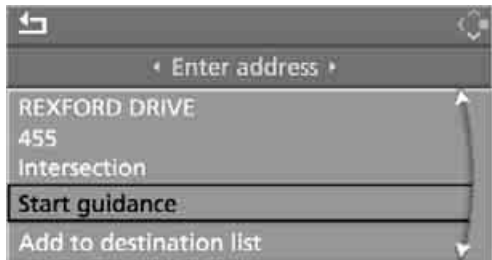

- ▷ Select "Start guidance" and press the controller.
Destination guidance starts immediately.
- ▷ If destination guidance is not to be started immediately:
Select "Add to destination list" and press the controller.
The destination is stored in the destination list, refer to page 131.

Entering destination via voice*

You can enter a desired destination with the voice command system. When entering the destination, it is possible to change between voice command and iDrive at any time. Reactivate the voice command function for this purpose if necessary.

- ▶ With 'Options' you can have the system read aloud the possible commands. ◀

1. Press the  button on the steering wheel or in the center console.

2. 'Enter address'



Selecting country

1. Wait for the system to ask for the country of destination.
2. Say the name of the country of destination.

Say the name of the country of destination in the language of the voice command system.

Entering town/city of destination

The town/city of destination can be spelled or entered as an entire word.

Spelling town/city of destination

To enter the town/city of destination, spell it using the customary spelling of the country of destination.

Pronounce the letters smoothly and at normal volume, avoiding excessive emphasis and pauses.

1. Spell town/city name:
Say at least the first three letters of the town/city of destination. The more letters you say, the more exactly the system recognizes the town/city.

The system can suggest up to 20 towns/cities of destination that match your entries.

Up to 6 entries are displayed at once on the Control Display.



- A destination is suggested by the system.
2. Select a town/city:
 - ▶ Select highlighted town/city: ›Yes‹
 - ▶ Select other town/city: ›No‹
 - ▶ Select entry, e.g. ›Entry 3‹
 - ▶ Display additional entries of the list: ›Next page‹
 - ▶ To respell the town/city: ›Repeat‹

The town/city can also be selected from the list via iDrive:

Turn the controller until the town/city of destination is selected and press the controller.

Entering the destination as an entire word*

Towns/cities of destination and streets located in the region where the language of the voice command system is spoken can be entered as an entire word.

Example: to enter a US town/city of destination as an entire word, the system language must be English.

The condition for this is the use of a suitable navigation DVD.

Speak smoothly and at normal volume, avoiding excessive emphasis and pauses.

1. Wait for the system to request the town/city of destination.
2. Say the name of the town/city of destination.

The system can suggest up to 6 towns/cities of destination that match your entries.

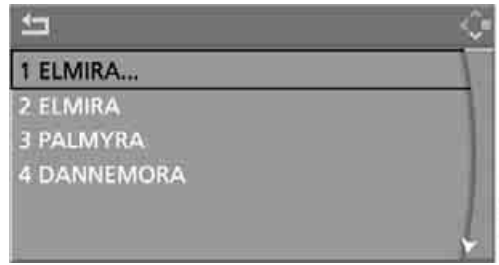

A destination is suggested by the system.

3. Select a town/city:
 - ▶ Select highlighted town/city: ›Yes‹
 - ▶ Select other town/city: ›No‹
 - ▶ Select entry, e.g. ›Entry 3‹
 - ▶ Reenter the town/city: ›Repeat‹
 - ▶ Enter town/city of destination by spelling it: ›Spell‹

The town/city can also be selected from the list via iDrive:

Turn the controller until the town/city of destination is selected and press the controller.

▶ Destinations that sound the same which cannot be differentiated by the system are summarized in a separate list and shown as a destination followed by three dots. Select this entry with ›Yes‹ if necessary. Then select the desired city/town in this list. ◀

Entering street and house number

The street is entered in the same way as the town/city of destination.

To enter the house number:

1. ›House number‹
2. Say the house number.

Up to 4-digit house numbers can be entered. Say the house number as individual digits.

Starting destination guidance

▶Start guidance‹

Destination guidance starts immediately.

Saving destination

The destination is added to the destination list or can be saved in the address book.

- ›Add to destination list‹ or
- ›Add to address book‹

Map-guided destination selection

If you only know the location of the town/city or street of the destination, then you can input the destination by using a map. You can use the cursor to select the destination on the map and then adopt it into the destination guidance.

1. Select "Navigation" and press the controller.
"New destination" is selected.
2. Press the controller.



3. Select "Input map" and press the controller.

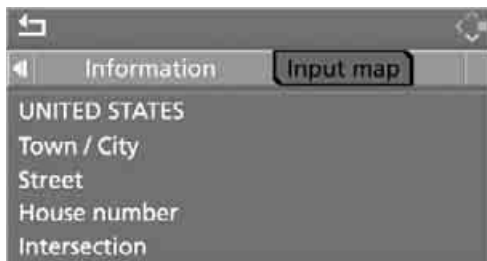

A section of a map is displayed on the Control Display:

- ▷ During destination guidance, around the current destination
- ▷ With the destination guidance deactivated, around the last destination entered



4. Select a destination with the cursor.
 - ▷ Changing scale: turn the controller.
 - ▷ Moving map: move the controller in the corresponding direction.
The controller can be moved to the left, right, forward and back.
5. Press the controller to accept or store the destination in the destination guidance system.
The selected town/city of destination and other menu items are displayed.
6. Select the desired menu item:
 - ▷ "Start route guidance" starts destination guidance.
 - ▷ "Show current position" places the current position in the center of the map.
 - ▷ "Show destination position" places the current destination in the center of the map.
 - ▷ "Return to map" changes back to the "Input map".
 - ▷ ↶ Exit the menu.

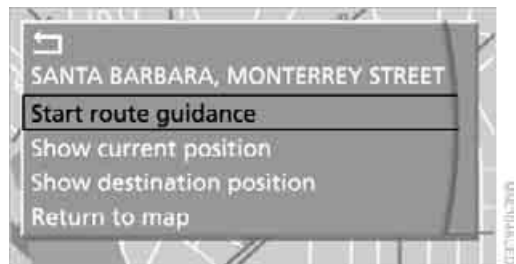

7. Press the controller.

The map for destination input can also be called up from the map view:

Select the  symbol and press the controller.

Selecting destination using information

You can obtain a display of selected destinations, e.g. hotels, sights or hospitals, and adopt them into the destination guidance.

1. Select "Navigation" and press the controller.
2. Select "Information" and press the controller.

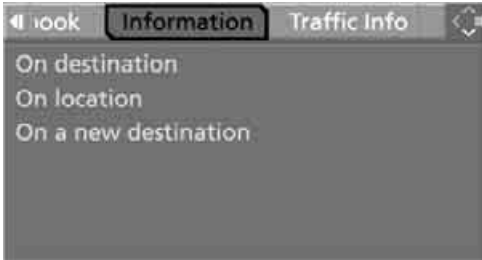

3. Select a location:
 - ▷ "On destination"
 - ▷ "On location"
 - ▷ "On a new destination"

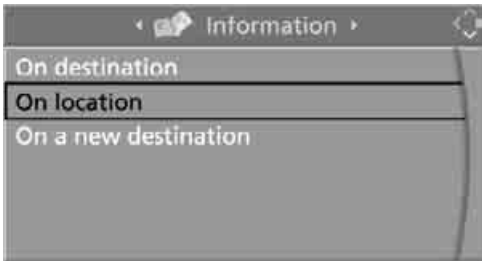





4. Press the controller.
5. Make your selection, e.g. "Hotels and restaurants", and press the controller.
6. Enter search criteria if necessary, e.g. the maximum distance from the current location.

7. Select "<Start search>" and press the controller.
These destinations are displayed on the Control Display.



8. Select a destination and press the controller.

 The scope of the information and symbols is dependent on the respective navigation DVD. ◀

9. Select the desired menu item:
 - ▷ To adopt the address into the destination list and start the destination guidance:
Select the  symbol and press the controller.
 - ▷ To establish a telephone connection:
Select the  symbol and press the controller.
 - ▷ To display additional destinations:
Select the  symbol and press the controller.
 - ▷ To start a new search:
Select the  symbol and press the controller.

To exit from the menu:

Select the  arrow and press the controller.

Symbols in map view

If, for example, you have selected the category Hotels, the hotels are shown on the map as symbols.

To hide the symbols in the map view:

1. Select the symbol and press the controller.



2. Select "Hide map icons" and press the controller.

The symbols are hidden.

To display the symbols:

Select "Show map icons" and press the controller.

To exit from the menu:

Select the  arrow and press the controller.

Destination list

The last 20 destinations entered into the destination list are displayed. You can select these destinations and adopt them into the destination guidance system.

For example, in order to plan a longer route, you can store all of the destinations you wish to visit in the destination list ahead of time, refer to Entering a destination manually on page 124.

Select "Navigation" and press the controller.



The last destination entered is the first item in the destination list.

 This symbol indicates the current destination during destination guidance.

To display other destinations in the destination list:

turn the controller.

Adopting the destination into the destination guidance system

1. Select the desired destination from the destination list and press the controller.
2. Select "Start guidance" and press the controller.

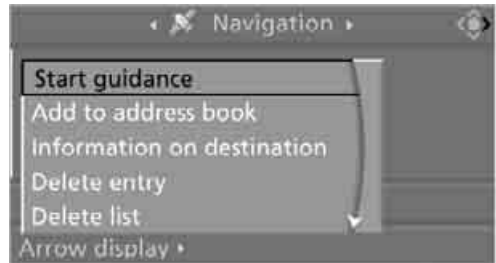

Editing the destination list

1. Select the desired destination from the destination list and press the controller.
2. The selected destination can be edited:
 - ▶ Saving entry:
Select "Add to address book".
 - ▶ Displaying information on destination:
Select "Information on destination".
 - ▶ Deleting entry:
Select "Delete entry".
 - ▶ Deleting all entries:
Select "Delete list". Destination guidance is switched off.
 - ▶ Changing entry:
Select "Edit". For operation, refer to Entering town/city of destination via name, page 125.
3. Press the controller.

Address book

Opening address book

iDrive, for explanation of principle, refer to page 16.

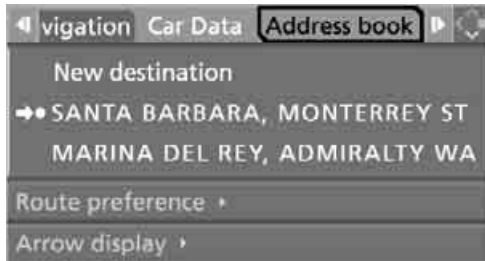

Select "Address book" and press the controller.

Storing destinations in address book

You can store approx. 100 destinations in the address book.

1. Select "Address book" and press the controller.
2. Select "New address" and press the controller.

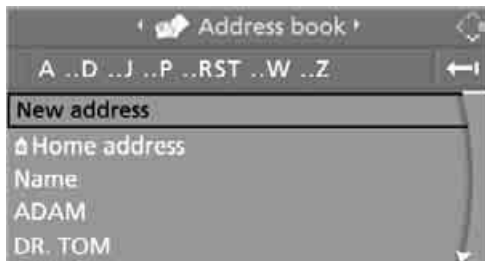

3. Select "Enter address" and press the controller.
4. Enter name and address, also refer to Entering a destination manually, page 124.
5. Select "Store in address book" and press the controller.
The entry is stored in the address book.

You can also store a destination from the destination list in the address book, refer to page 131.

Storing current position*

The current position can be adopted into the address book.

1. Select "Address book" and press the controller.
2. Change into the third field from the top. Turn the controller until "New address" is selected and press the controller.

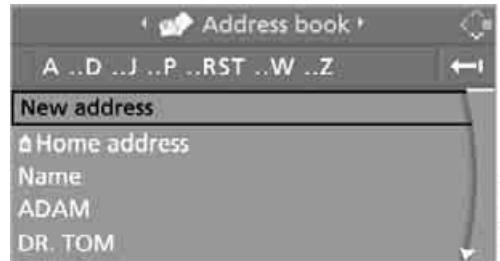

3. Select "Use current location as address" and press the controller.
The name given can be changed. For operation, refer to Entering a destination manually, page 124.
4. Select "Store in address book" and press the controller.

You can also enter your current position in the address book if you have left the sector covered by the navigation DVD. In this case, you must enter a name.

Selecting destinations from address book

1. Select "Address book" and press the controller.
The stored entries are displayed on the Control Display.

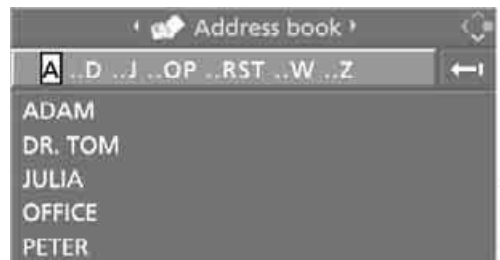

2. Select the entry and press the controller.
To start destination guidance:
Select "Start guidance" and press the controller.

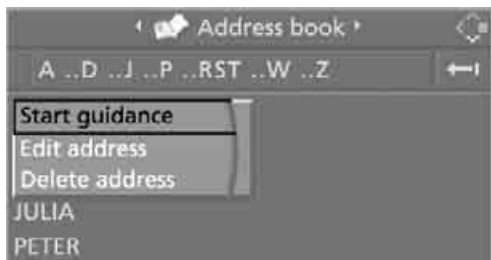

Changing destinations from address book

1. Select "Address book" and press the controller.
2. Select the entry and press the controller.
3. Select "Edit address" and press the controller.

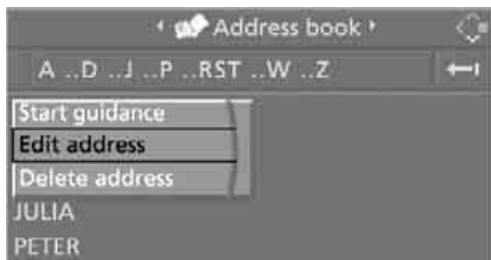

4. Change entry.
For operation, refer to Entering a destination manually, page 124.
5. Select "Store in address book" and press the controller.

Deleting individual destinations from address book

1. Select "Address book" and press the controller.
2. Select the entry and press the controller.
3. Select "Delete address" and press the controller.

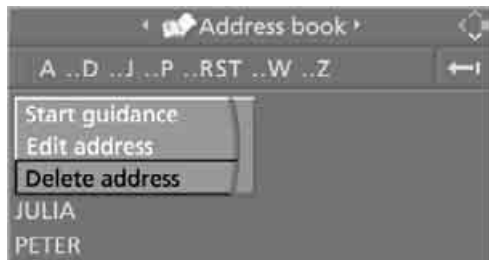

4. Select "Yes" and press the controller.

Deleting all destinations from address book

1. Open the start menu.
2. Press the controller to open the **i** menu.
3. Select "Settings" and press the controller.
4. Select "Vehicle / Tires" and press the controller.
5. Change to upper field if necessary. Turn the controller until "Delete data" is selected and press the controller.



6. Select "Delete address book" and press the controller.
7. Select "Yes" and press the controller.

Storing home address

You can store your current position or the current destination as a home address in the address book. This entry is in the second position in the address book.

1. Select "Address book" and press the controller.
2. Change into the third field from the top. Turn the controller until "Home address" is selected and press the controller.

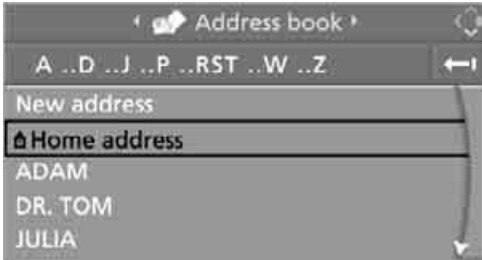

3. Select "Use current location as address", or "Save current destination" during the destination guidance, and press the controller.
4. Select "Store in address book" and press the controller.

Adopting home address as destination

1. Select "Home address" and press the controller.
2. Select "Start guidance" and press the controller.

Changing home address

1. Select "Home address" and press the controller.
2. Select "Edit address" and press the controller. For operation, refer to Entering a destination manually, page 124.

Selecting route

You can influence the calculated route by choosing certain route criteria. You can change the route criteria as often as you like when entering the destination and whenever the destination guidance is active.

The route is planned according to fixed rules, taking the road type into account, e.g. whether it involves freeways or winding roads. The road types are stored on the navigation DVD. As a result, the routes recommended by the navigation system may not always be the same ones that you would choose based on personal experience.

Changing route criteria

1. Select "Navigation" and press the controller.
2. Change into the third field from the top. Turn the controller until "Route preference" is selected and press the controller.

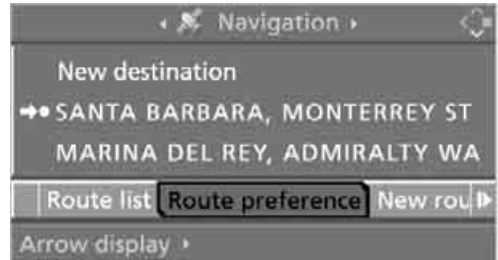

The various criteria are listed on the Control Display.

3. Select a route criterion for the route:
 - ▷ "With highways"
Freeways and major traffic arteries are given priority.
 - ▷ "Avoid highways"
Freeways are avoided where possible.
 - ▷ "Fast route"
The short traveling time, being a combination of the shortest possible route and the fastest roads
 - ▷ "Short route"
Short route, regardless of how fast or slow progress will be

4. Press the controller.

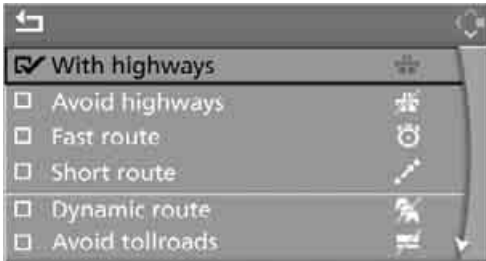

The route criterion is selected.

5. If necessary, select an additional route criterion and then press the controller:
 - ▷ "Dynamic route"*
Automatic changing of the route in case of traffic obstructions. Depending on the type of road as well as the type and length of traffic obstruction, the route can also be calculated in a way that passes through the traffic obstruction.
 - ▷ "Avoid tollroads"
Tollroads are avoided where possible.
 - ▷ "Avoid ferries"
Ferries are avoided where possible.

To exit from the menu:

Select the  arrow and press the controller.

The route criteria can also be changed in the arrow or map view:

1. Select the symbol for the route criterion and press the controller.
2. Select a route criterion and press the controller.

Word matching principle

The system supports the word matching principle to make it easier for you to enter the names of streets or towns/cities. The system runs ongoing checks, comparing your destination entries with the data stored on the navigation DVD as the basis for instant response. The user benefits include:

- ▷ Names of specific towns/cities can also vary from the official versions, provided that the spelling of the entry corresponds to a standard form used in another country.

Example:

Instead of "Munich", you can also enter the German spelling "München" or the Italian spelling "Monaco".

- ▷ When you are entering the names of towns/cities and streets, the system will complete them automatically as soon as enough letters are available to ensure unambiguous identification.
- ▷ The system only accepts name entries beginning with letters that are stored on the navigation DVD. The system will not accept nonexistent names and addresses.

Destination guidance

Starting destination guidance

1. Change to upper field if necessary. Turn the controller until "Navigation" is selected and press the controller.
2. Select a destination from the destination list and press the controller or enter a new destination, refer to page 124.



3. Select "Start guidance" and press the controller.

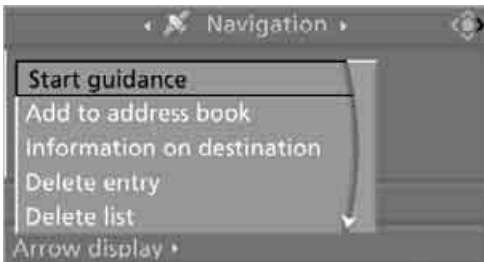

After the route has been calculated, destination guidance is indicated by arrows or a map display on the Control Display.

▶ If the route criteria "Avoid highways", "Avoid tollroads" or "Avoid ferries" are selected, the calculation time for the route can increase considerably. ◀

The destination guidance can also be started in the arrow or map view:

Select the ➡● symbol and press the controller.

During destination guidance, you can operate other equipment via iDrive at any time. You are notified well in advance of a necessary change of direction by spoken instructions and the display of the direction arrows.

Terminating/continuing destination guidance

In arrow display or map view

Select the ➡● symbol and press the controller.

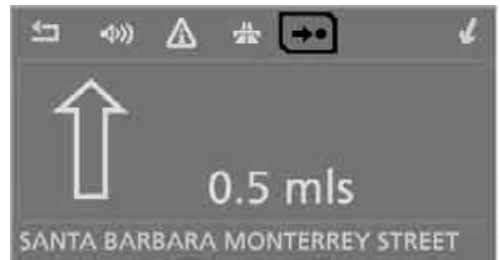

In destination list

➡● This symbol marks the current destination.

1. Select the current destination and press the controller.



2. Select "Stop guidance" and press the controller.

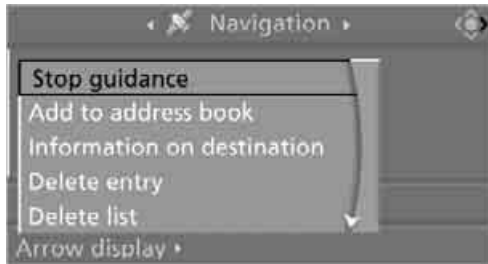

If the destination was not reached before the end of the last trip, upon restarting you will see the question:

"Continue guidance to destination?".

The destination guidance starts automatically after a short time.

To start destination guidance immediately: Select "Yes" and press the controller.

Displaying route

You have the option of displaying various views of the route during destination guidance.

 From another menu, you can change directly to the screen last displayed, refer to Comfort opening of menu items, page 18. ◀

Displaying arrow display

1. Select "Navigation" and press the controller.
2. Change into the fourth field from the top. Turn the controller until "Arrow display" is selected and press the controller.

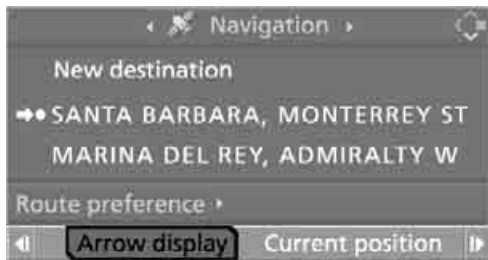

The arrow display is displayed.



- 1 Switching voice instructions on/off
- 2 Manually displaying traffic information*
- 3 Selecting route criteria
- 4 Starting/stopping destination guidance
- 5 Arrow to destination as the crow flies
- 6 Distance to the next change of direction
- 7 Current position
- 8 Direction of travel

▶ Hollow arrow:
Destination guidance on the calculated route.

▶ Solid arrow:
Arrow shows the route to be calculated from a bird's eye view when the vehicle is not located in an area contained on the navigation DVD, e.g. in a multilevel parking lot.

Depending on the equipment, the estimated time of arrival and the distance to the destination are displayed in the top or bottom line of the Control Display.

Before a change of direction, the appearance of the arrow changes.



- 1 Street name for change of direction
- 2 Distance to change of direction
- 3 Change of direction

To exit from the menu:
Select the  arrow and press the controller.

Displaying map view

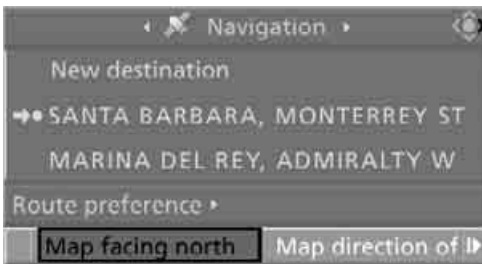

You can have your current position displayed on a map. After starting the destination guidance, the planned route is shown on the map.

1. Select "Navigation" and press the controller.
2. Change into the fourth field from the top. Turn the controller until the desired map view is selected:
 - ▷ "Map facing north"
 - ▷ "Map direction of travel"
 - ▷ "Perspective"



3. Press the controller.



- 1 Switching voice instructions on/off
- 2 Starting/stopping destination guidance
- 3 Selecting destination using map
- 4 Displaying the menu in which the information last selected can be displayed/hidden, refer to Selecting destination via information on page 130
- 5 Changing map view
 - ▷  "Map facing north"
 - ▷  "Map direction of travel"
 - ▷  "Perspective"
- 6 Changing route criteria
- 7 Manually displaying traffic information*
- 8 Arrow to destination as the crow flies

The estimated time of arrival and the distance to the destination are shown in the bottom line of the Control Display.

To exit from the menu:

Select the  arrow and press the controller.

At scales of less than 250 miles/500 km, you have the option of deciding whether to orient the map to north or toward your current direction of travel. At scales of 250 miles/500 km or greater, the map always points toward north.

Changing map view



Select the corresponding symbol and press the controller.

The next map view is displayed.

Changing scale

Turn the controller to change the scale.

Displaying towns/cities and streets of the route

You can have the roads and towns along the route displayed during destination guidance.

The distances remaining to be traveled on each individual road are also displayed.

1. Select "Navigation" and press the controller.
2. Change into the third field from the top. Turn the controller until "Route list" is selected and press the controller.

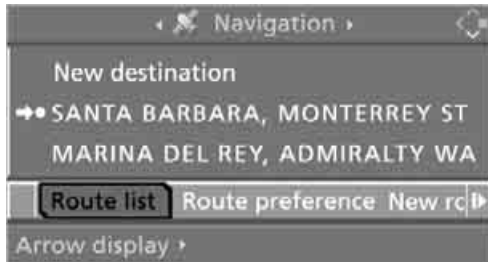

To exit the menu:
Select the  arrow and press the controller.

Destination guidance with voice instructions

Switching voice instructions on/off



Voice instructions can be switched on or off during the destination guidance in the arrow or map view:

Select the  symbol and press the controller.

To switch the voice instructions on/off at any time:

1. Press the **MENU** button.
This opens the start menu.
2. Press the controller to open the **i** menu.
3. Turn the controller until "Settings" is selected and press the controller.



4. Turn the controller until "Language / Units" is selected and press the controller.
5. Change to upper field if necessary. Turn the controller until "Languages" is selected and press the controller.

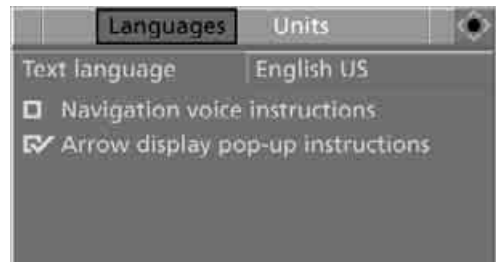

6. Select "Navigation voice instructions" and press the controller.

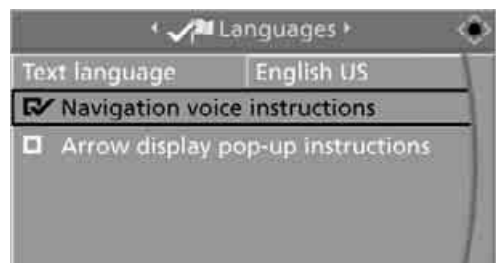

 The voice instructions are switched on.

The setting is stored for the remote control currently in use*.

Repeating and canceling voice instructions

With the programmable button on the steering wheel you can also make the following settings, refer to page 53:

- ▷ Repeat the voice instruction:
Press the button.
- ▷ Switch voice instructions on/off:
Press button longer.

Setting volume of voice instructions

The volume can only be adjusted during a voice instruction.

1. Repeat the last voice instruction, if required.
2. Turn the knob during the voice instruction to select the desired volume.



This volume is independent of the volume of the audio sources.

The setting is stored for the remote control currently in use.

Bypassing route sections

During destination guidance, you can revise the navigation system's route recommendations to avoid particular stretches of road. Enter the number of miles/kilometers that you want to travel before returning to the original route.

1. Select "Navigation" and press the controller.
2. Change into the third field from the top. Turn the controller until "New route" is selected and press the controller.

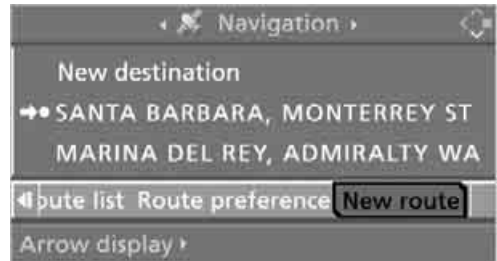

3. Turn the controller to enter the desired number and press the controller.

The route is recalculated.

To exit from the menu without changing the route:

Select the  arrow and press the controller.

Traffic information*

In population centers you can display traffic information from radio stations that transmit information of the Traffic Info traffic warning service. This information of the traffic warning services is constantly updated using measuring data from traffic routing centers and information from traffic congestion indicators.

During destination guidance the traffic information located near you on the route is automatically displayed. Regardless of whether the destination guidance is active, you can display the traffic information in the map view or in a list.

Switching reception of traffic information on/off

1. Press the **MENU** button.
This opens the start menu.
2. Press the controller to open the **i** menu.
3. Turn the controller until "Settings" is selected and press the controller.



4. Turn the controller until "Traffic Info settings" is selected and press the controller.

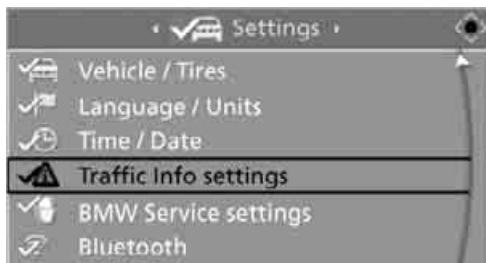

5. Select "Traffic Info" and press the controller.

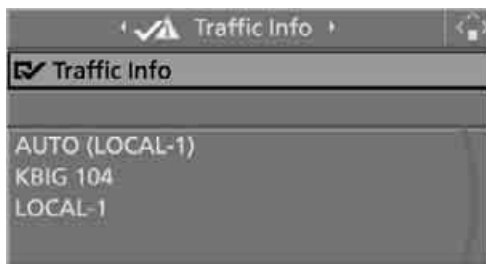

The traffic information can be received and displayed.



"AUTO": automatic selection of the Traffic Info station with the strongest reception.

 Depending on the station, either the station name, frequency, local number or other information is displayed. ◀

Manually displaying traffic information

During destination guidance

Traffic information can be displayed manually during destination guidance in the arrow or map view.

 If the symbol is shown with a red border, traffic information is available for the planned route. Select the  symbol and press the controller.

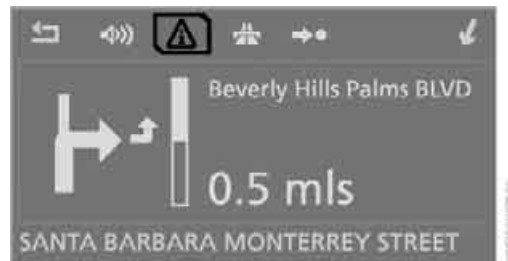

During destination guidance, the traffic information on the planned route is marked with a yellow lozenge.

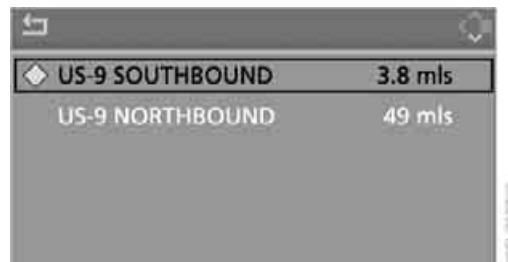

First the traffic information along the planned route is shown sorted according to the distance to the current vehicle position.

With destination guidance switched off

1. Open the start menu.
2. Move the controller to the right to call up "Navigation".
3. Select "Traffic Info" and press the controller.

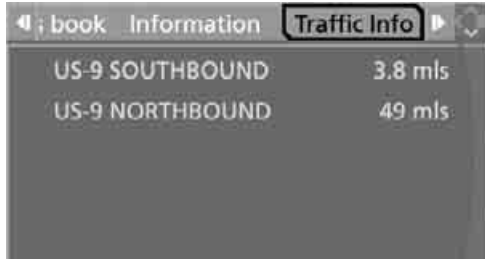

First the traffic information along the planned route is shown sorted according to the distance to the current vehicle position.

Displaying detailed traffic information



Select a traffic information item from the list and press the controller.



To exit from the menu:
Select the  arrow and press the controller.





Depiction of traffic information in map view

The traffic information symbols are shown in the map view up to a scale of 100 miles/200 km.

-  Traffic event with map scales greater than 5 miles/10 km, arrow points in the direction of travel concerned
-  Several traffic events have been received. Select a smaller scale to display these individually.



With a scale of up to 5 miles/10 km, additional information is displayed. The length, direction and effect of a traffic obstruction are indicated with arrows along the route, e.g.

-  Slow traffic or other event
-  Traffic back up
-  Stopped traffic
-  Traffic event in both directions of travel

Along planned route

Colored symbol with the traffic obstruction symbol.

Outside planned route

- ▷ Map scale up to 5 miles/10 km:
White symbol with black or gray border with the traffic obstruction symbol
- ▷ Map scale from 10 miles/20 km:
White symbol with black border and an arrow in the direction concerned

Traffic information during destination guidance

The system behavior varies depending on whether "Dynamic route" is selected.

Displaying traffic obstructions

If a traffic obstruction is reported to the navigation system and "Dynamic route" is not selected, you will be provided with certain information from a distance of approx. 25 miles/40 km, e.g. the length of the traffic congestion. The last possible junction will be displayed shortly before this.



Select "Detour" and press the controller. The navigation system determines a new route to bypass the traffic congestion. This information is also displayed if you have called up a different application on the Control Display.

Hiding traffic obstructions

If "Dynamic route" is selected, the route in case of traffic obstructions is automatically changed. The system does not point out traffic obstructions along the original route. Depending on the type of road as well as the type and length of traffic obstruction, the route can also be calculated in a way that passes through the traffic obstruction.

Symbols for traffic information

-  Traffic light failure
-  Roadwork
-  General traffic obstruction
-  Transport of hazardous load
-  Vehicle on wrong carriage way
-  Danger
-  Low clearance
-  No parking
-  Fog
-  Heavy rain
-  Slippery road
-  Cross winds
-  Smog
-  Road close
-  Slow traffic
-  Traffic back up
-  Stopped traffic
-  Icy roads
-  Uneven surface
-  Accident
-  Lane closure
-  Delay
-  Police checkpoint

Displaying current position

You can also display your current position with the destination guidance switched off.

1. Select "Navigation" and press the controller.
2. Change into the fourth field from the top. Turn the controller until "Current position" is selected and press the controller.

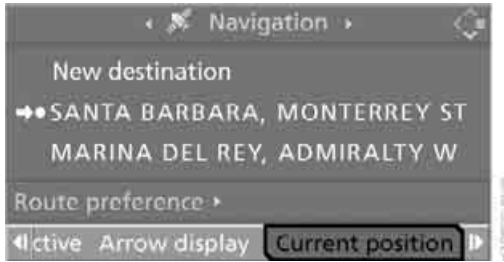

The current position of your BMW is displayed.

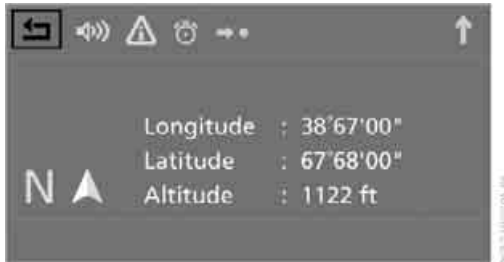

If the navigation system is unable to identify a town or city, your current map coordinates will appear.

To exit from the menu:

Select the  arrow and press the controller.

You can also have the current position displayed on a map, refer to page [138](#).

What to do if ...

What to do if ...

- ▷ a navigation DVD is inserted, but the request to insert the DVD is displayed on the Control Display?
The navigation DVD may not be the right DVD for the navigation system. The DVD is labeled accordingly.
 - ▷ you request the current position of your vehicle, but do not receive a precise display?
The system is unable to receive enough GPS signals at your current position due to obstructions, your position is not yet available on your navigation DVD, or the system is in the process of calculating your position. As a rule, reception is guaranteed in the open air.
 - ▷ the destination guidance does not accept a destination?
The data of the destination is not stored on the navigation DVD that is loaded. Select a destination that is as close as possible to the original.
 - ▷ the destination guidance does not accept a destination without the street name?
On the navigation DVD, no downtown area can be determined for the city or town entered. Enter any street, or a destination such as the railway station etc., then start the destination guidance.
 - ▷ you want to enter a destination for the destination guidance, but it is not possible to select the letters for your desired entry?
The data of the destination is not stored on the navigation DVD that is loaded. In this case, the system will not offer you any letters to choose from. Select a destination that is as close as possible to the original.
- ▷ the system stops furnishing directions on which way to turn as you approach intersections?
You are driving in an area that has not yet been completely recorded on the navigation DVD. Instead of an arrow indicating a turn, you will see an arrow which indicates the general direction of your planned route. Or you have left the recommended route and the system requires a few seconds to calculate a new recommended route.
 - ▷ the navigation system does not react to entries?
If the battery has just been reconnected after having been disconnected, it then takes up to 10 minutes before the system is once again operational.





Entertainment

This chapter describes the operation of the radio and CD player as well as their tone settings.

On/off and tone

The following audio sources have shared controls and setting options:

- ▷ Professional* radio or Business radio
- ▷ CD player
- ▷ CD changer*

Controls

The audio sources can be operated using:

- ▷ Buttons near CD player
- ▷ iDrive
- ▷ Buttons on steering wheel, refer to page 11

Buttons near CD player

The layout of the buttons can vary depending on your vehicle's equipment.

One drive:

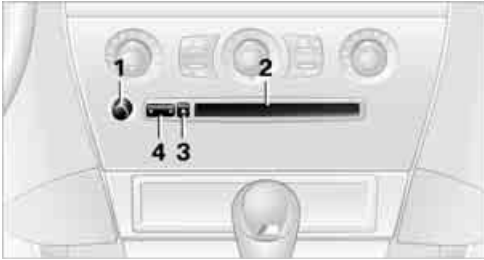

Two drives:

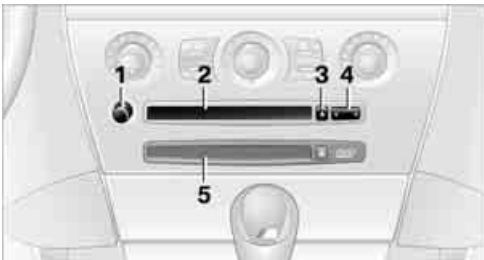

- 1 Entertainment sound output on/off, volume
 - ▷ Press: switch on/off.
When you switch on, the last set radio station or CD track is played.
 - ▷ Turn: adjust volume.
- 2 Drive for audio CDs
- 3 Eject CD
- 4 Station scan/track search
 - ▷ Change radio station.
 - ▷ Select track for CD player and CD changer.
- 5 Drive for navigation DVDs

Operating via iDrive

1. Press the **MENU** button.
This opens the start menu.
2. Move the controller backwards to call up "Entertainment".



You have the following choices:

- ▷ "FM" and "AM": radio reception
- ▷ "WB": Weather Band station
- ▷ "SAT": satellite radio
- ▷ "CD": CD player or CD changer
- ▷ "AUX": AUX-In connection
- ▷ "Set": depending on the audio source, other adjustments can be made, e.g. with the radio: update station with strongest reception, store station, tone control, sample stations.

 From another menu, you can change directly to the screen last displayed, refer to Comfort opening of menu items, page 18. ◀

With the ignition key in radio-ready position or higher, the selected audio source is stored for the remote control currently in use.

Switching on/off

To switch the Entertainment sound output on/off:

Press knob **1** next to the CD player.

 This symbol on the Control Display indicates that sound output is switched off.

For a single drive, the sound output is available for approx. 20 minutes with the ignition switched off.

To do so, switch the sound output on again.

Adjusting volume

Turn knob **1** next to the CD player until the desired volume is set.

You can also adjust the volume with the buttons on the steering wheel, refer to page 11.

From radio readiness, the setting for the remote control used at the moment is saved.

Tone control

You can alter various tone settings, e.g. treble and bass, or the speed-dependent volume increase.

The sound settings are globally adjusted for all audio sources.

From radio readiness, the settings are saved for the remote control used at the moment.

Changing tone settings

1. Press the **MENU** button.
This opens the start menu.
2. Press the controller to open the **i** menu.

3. Turn the controller until "Settings" is selected and press the controller.



4. Select "Audio" and press the controller.
The tone settings can also be selected when you have opened "Entertainment" in the start menu:
Select "Set" and then "Tone", and press the controller.

Treble and bass

1. Change to upper field if necessary. Turn the controller until "Treble / Bass" is selected and press the controller.



2. Move the controller to the left or right to select "Treble" or "Bass".



3. Turn the controller until the desired setting is selected.

Balance and fader

You can adjust the volume distribution in the same manner as "Treble / Bass".

- ▷ "Balance": left/right volume distribution
- ▷ "Fader": front/rear volume distribution

Speed-dependent volume control

The speed-dependent volume control automatically increases the volume with increasing speed. You can set various stages for the increase in volume.

1. Select "Speed volume" and press the controller.

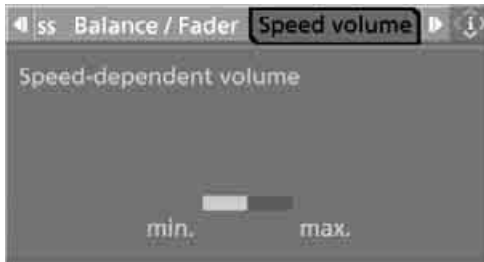

2. Turn the controller:
The adjustment is applied; the field can be changed.



Individual high-end sound system*

You can choose between Stereo and Surround.

1. Select "Surround Settings" and press the controller.



2. Select "Stereo" or "Surround".

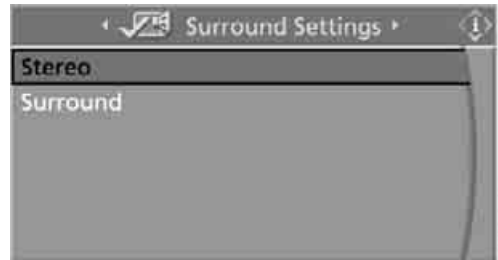

3. Press the controller.
The spatial sound effect is activated.

Professional LOGIC7 HiFi System*

You can select a spatial sound effect that improves the spatial acoustics in all frequency ranges.

1. Select "Surround Settings" and press the controller.



2. Select "Concert hall" or "Theater".



3. Press the controller. LOGIC7 spatial sound is switched on.

To switch off spatial sound:
Select "Off" and press the controller.

LOGIC7 and the LOGIC7 logo are registered trade marks of Lexicon, Inc., a company of the Harman International Group.

Equalizer*

You can set individual sound frequency ranges:

1. Select "Equalizer" and press the controller.



2. Move the controller to the left or right to select the desired frequency range.

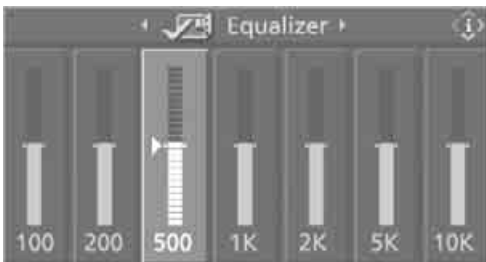

3. Turn the controller until the desired setting is selected.

Resetting tone settings

You can reset all tone settings to the default settings.

1. Open the start menu.
2. Press the controller to open the **i** menu.
3. Turn the controller until "Settings" is selected and press the controller.
4. Select "Audio" and press the controller.
5. Change to upper field if necessary. Turn the controller until "Reset" is selected and press the controller.



With two drives: select "Yes".

Radio

Your radio provides reception of the FM and AM wavebands.

Listening to radio



Press the button if the sound output is switched off.

1. Press the **MENU** button.
This opens the start menu.
2. Move the controller backwards to call up "Entertainment".
3. Change to upper field if necessary. Turn the controller until "FM" or "AM" is selected.



4. Press the controller.

Stations are shown on the Control Display on the basis of various selection criteria, e.g. "Presets".

If "Autostore" does not display any stations or if the stations displayed can no longer be received, to update the station with the strongest signal, refer to page [153](#).

Changing stations



Turn the controller.

In addition to the stations currently displayed, you can have stations with another selection criterion displayed.

Professional* radio

You can choose from the following selection criteria:

- ▷ "All stations":
Stations that can currently be received in the "FM" waveband.
- ▷ "Autostore":
The stations with the strongest received signals in the "AM" waveband.
With High Definition Radio: the stations with the strongest received signals in the "FM" waveband.
- ▷ "Presets":
Stations you have stored, refer to page [154](#).
- ▷ "Manual":
Set stations that are received in addition to those displayed.

Business radio

You can choose from the following selection criteria:

- ▷ "Autostore":
The stations with the strongest signal, refer to page [153](#).
- ▷ "Presets":
Stations you have stored, refer to page [154](#).

- ▷ "Manual":
Set stations that are received in addition to those displayed.

Changing selection criteria

1. Change into the second field from the top.
2. Turn the controller until the desired selection criterion is selected and press the controller.



Buttons next to CD player

Press the  button for the corresponding direction.
The system changes to the next displayed station.
You can also change stations with buttons on the steering wheel, refer to page 11.

Sampling stations, scan

The system automatically plays a brief sample from each of the stations on the current waveband.

1. Select "FM" or "AM" and press the controller.
"Set" is selected.
2. Press the controller.
Other menu items are displayed.
3. Select "Scan" and press the controller.



The stations are sampled.

To end sampling:

1. Press the controller.
2. Select "Scan" and press the controller.

This cancels sampling of the stations, and the radio remains on the current station.

Buttons next to CD player

To sample the stations, press and hold the  button for the corresponding direction.
To stop scanning, press the button again.

Selecting frequency manually

With "Manual" you can select stations that are received in addition to those displayed.

1. Select "FM" or "AM" and press the controller.
2. Change into the second field from the top.
3. Select "Manual" and press the controller.



4. Turn the controller to set a certain frequency.

Updating stations with best reception

For Professional radio with "AM" and Business radio:

If you are on a longer journey and leave the transmission range of the stations originally set, you can update the list of stations with the best reception signal.

1. Select "FM" or "AM" and press the controller.
2. Change into the second field from the top.
3. Select "Autostore" and press the controller.
"Set" is selected.



4. Press the controller. Other menu items are displayed.
5. Select "Autostore" and press the controller.



The display of the stations with the strongest reception is updated. The frequencies of the stations are displayed.

Storing stations

1. Select "FM" or "AM" and press the controller.
2. Change into the second field from the top. Turn the controller until the desired selection criterion is selected and press the controller.
3. Select the desired frequency or station. "Set" is selected.



4. Press the controller. Other menu items are displayed.
5. Select "Store" and press the controller.

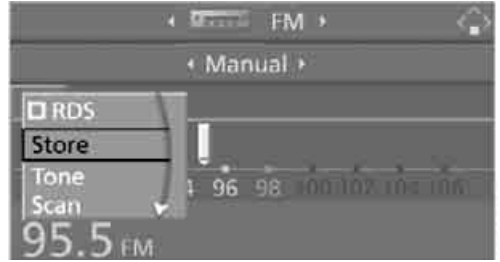

"Presets" is displayed.

6. Turn the controller until the desired memory position is selected.
7. Press the controller. The station is stored.



The stations of the last selection criterion are displayed once again after a short time.

From radio readiness, the stations are saved for the remote control used at the moment.

Changing a memory position

1. Select "Presets" and press the controller.
2. Select the desired station. "Set" is selected.
3. Press the controller. Other menu items are displayed.
4. Select "Store" and press the controller.



- Turn the controller until the desired memory position is selected. The number of the memory position appears beside the name or frequency of the station.
- Press the controller. The station is stored.

RDS Radio Data System

In the FM frequency range, additional information is transmitted via RDS. If the reception conditions are good, the station names are shown on the Control Display. If the reception is weak or disrupted, it can take some time before the station names are displayed.

Switching RDS on/off*

- Select "FM" or "AM" and press the controller. "Set" is selected.
- Press the controller. Other menu items are displayed.
- Select "RDS" and press the controller.



- RDS is activated. The setting is stored for the remote control currently in use.

Automatically sorting stations*

For the "All stations" selection criterion, you can set whether the most frequently used stations are displayed at the beginning.

- Select "All stations" and press the controller. "Set" is selected.
- Select "Favorites" and press the controller.



- The most frequently used stations are shown at the beginning.

Weather news flashes*

Weather Radio is a service of the National Oceanic and Atmospheric Administration (NOAA) of the US Department of Trade. Weather news flashes are repeated every 4 to 6 minutes and are routinely updated at intervals of 1 to 3 hours, and more often when necessary. Most stations operate 24 hours a day. In case of a storm, the National Weather Service interrupts the routine weather news and transmits special warning messages instead. If you have a question about NOAA Weather Radio, please contact the nearest office of the National Weather Service. Details are also provided on the Internet at www.nws.noaa.gov.

Calling up weather news flashes

1. Select "WB" and press the controller.



2. Select a station.

The station for weather news flashes may be unavailable in some regions.

High Definition Radio*

Many stations transmit both analog and digital signals. You can receive these stations digitally and with improved sound quality.

A digital radio network must be available in order to receive digital stations

Activating/deactivating digital radio reception

1. Press the **MENU** button.
This opens the start menu.
2. Press the controller to open the **i** menu.
3. Turn the controller until "Settings" is selected and press the controller.
4. Select "Audio" and press the controller.
5. Change to upper field. Turn the controller until "HD radio" is selected and press the controller.



6. Select "Off" and press the controller.
 The reception of digital stations is deactivated.

HD This symbol is displayed when a station is being received digitally.



With some stations the digital signals are not transmitted simultaneously with the analog signals. If you are in an area in which the selected station is not continuously received digitally, playback switches between analog and digital reception. This can result in repetitions or interruptions. In this case it may be advisable to deactivate digital radio reception.

Selecting programs of a digital station*

Some stations transmit several programs. To select one of these programs:

1. Select "FM" or "AM" and press the controller.



2. Select "Manual" and press the controller.
3. Select a station that is received digitally.
HD This symbol is displayed when a station is being received digitally.
4. Switch to the next program of the digital station with the buttons on the radio or the steering wheel.

Updating stations offering digital reception

If you are on a longer journey and leave the transmission range of the stations originally set, you can update the list of stations with the best reception signal.

1. Select "FM" or "AM" and press the controller.



2. Change into the second field from the top.
3. Select "Autostore" and press the controller.



4. Press the controller.
Other menu items are displayed.
5. Select "Autostore HD" and press the controller.



The display of the stations offering digital reception is updated. This can take up to 2 minutes.

Displaying additional information

With the digital stations, additional information on the current track is displayed, e.g. the name of the artist.

1. Select a station and press the controller.
2. Select "Details" and press the controller.



The information is displayed.



If a digital station is received again when the station is changed, the additional information will be displayed again following a brief interruption.

Satellite radio*

You can receive up to 100 different channels with high sound quality.

The channels are offered to you in predefined packages. To receive the channels of your choice, you must have this package enabled.

With this new technology the signal may fail, causing interruptions in reception. ◀

Enabling or disabling channels

1. Press the **MENU** button.
This opens the start menu.
2. Move the controller backwards to call up "Entertainment".
3. Select "SAT".



4. Press the controller.

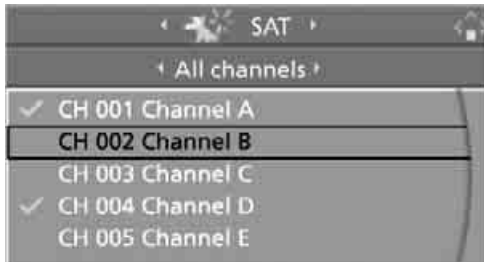

The channels are displayed.

- ✓ These channels are enabled.

Enabling

1. Select a channel that has not yet been enabled and press the controller.
A telephone number and the electronic serial number, ESN, are displayed.
 The electronic serial number is required for enabling or disabling. ◀
2. To enable the channels:
Dial phone number.

Disabling

1. Select an enabled channel and press the controller.

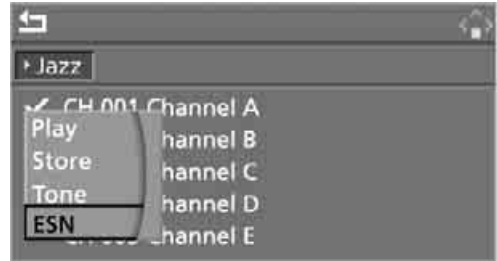

2. Select "ESN" and press the controller.
The electronic serial number, ESN, is displayed.



The electronic serial number is required to disable. ◀

3. To have the channels disabled:
Dial phone number.

Selecting and storing channel

1. Select "SAT" and press the controller.



Channels are shown on the Control Display sorted on the basis of selection criteria.

2. Select a menu item:
 - ▷ "Presets":
Up to twelve channels you have stored previously.
 - ▷ "All channels":
All channels are displayed.
 - ▷ "Categories":
All channels sorted by category, e.g. news, jazz.



3. Press the controller.
4. If "Categories" has been selected: Select the desired category and press the controller.



The channels of this category are displayed.

5. ✓ Select a channel marked with this symbol.

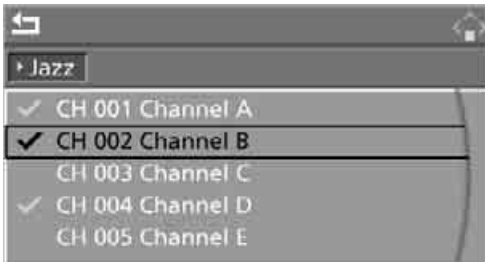

6. Press the controller. Other menu items are displayed.

7. Select "Play" and press the controller.

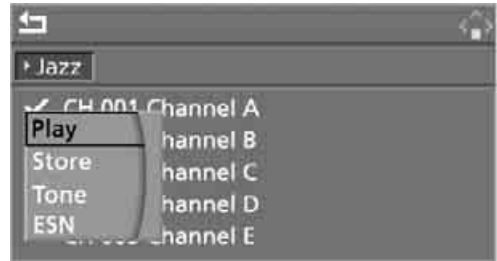

Additional information

The name of the channel and additional information on the current track are displayed, e.g. the name of the artist.

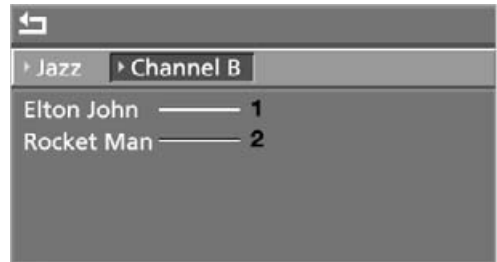

- 1 Artist
- 2 Track

Storing channel

1. Select the desired channel.
2. Press the controller. Other menu items are displayed.
3. Select "Store" and press the controller.

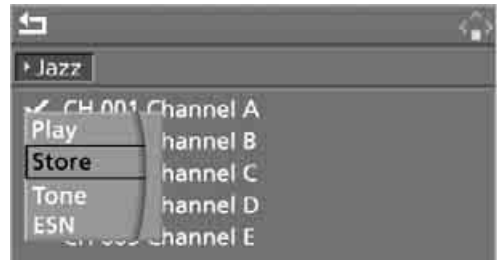

"Presets" is displayed.

- Turn the controller to select a memory position and press the controller.

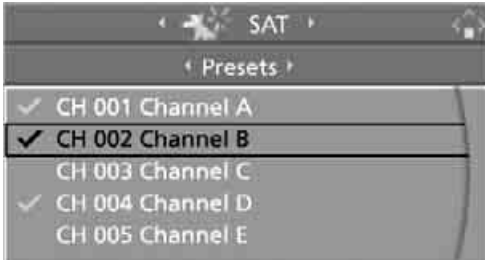

The channel is stored. The stations of the last selection criterion are displayed again after a short time.

Changing channel with buttons next to CD player

Press the  button for the corresponding direction.

The system changes to the next enabled channel.

Notes

If no signal can be received for more than 4 seconds, a message is displayed on the Control Display.



Reception may not be possible for certain reasons, e.g. environmental influences or topographical conditions. The satellite radio has no influence on this.

The signal may not be available in tunnels or underground garages, next to tall buildings, near trees, mountains or other sources of radio interference.

Reception is usually possible again as soon as the signal is available again. ◀

CD player and CD changer*

Listening to CDs

Compressed audio files*

CDs with compressed audio files, i.e. MP3, can be played by the CD player, but not by the CD changer.

CD player: starting CD



With two drives:

The upper drive is for audio CDs.

Insert the CD into the drive with the labeled side up. The CD is automatically pulled in.

Playback starts automatically if the sound output is on. For CDs with compressed audio files, it can take up to approx. 1 minute to read in the data depending on the directory structure.

To start playback when there is already a CD in the drive:

1. Press the **MENU** button.
This opens the start menu.
2. Move the controller backwards to call up "Entertainment".

3. Change to upper field if necessary. Turn the controller until "CD" is selected and press the controller.



4. With a CD changer, change to the second field from the top and turn the controller until "CD" is selected and press the controller.
The CD player is started.



Playback starts automatically if the sound output is switched on.

Press the  button next to CD player.
The CD emerges slightly from the drive.

CD changer: starting CD

Fill the CD magazine and insert, refer to page 165.

1. Press the **MENU** button.
This opens the start menu.
2. Move the controller backwards to call up "Entertainment".
3. Change to upper field if necessary. Turn the controller until "CD" is selected and press the controller.

- Change to the second field from the top if necessary. Turn the controller until the desired CD, CD 1 - 6, is selected and press the controller.



At the end of the last track, the next CD will be selected.

If the CD magazine has been newly filled, playback begins with the lowest CD, e.g. CD 1, track 1.

The CD magazine's load status is indicated on the Control Display.

Selecting a track

Buttons next to CD player

Press the button for the corresponding direction repeatedly until you reach the desired track.

The CD will start to play at the start of the track. The track is displayed on the Control Display.

You can also change the track with buttons on the steering wheel, refer to page 11.

Via iDrive

Select a track by turning the controller.



Compressed audio files*

- Select the directory if necessary and press the controller.



- Select the track and press the controller.

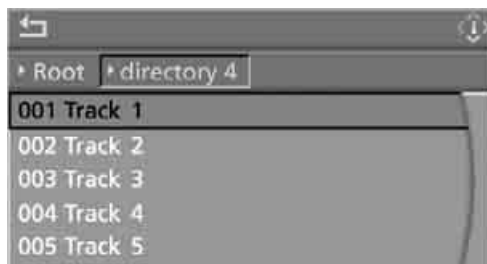

To change the directory:

Select the directory and press the controller.

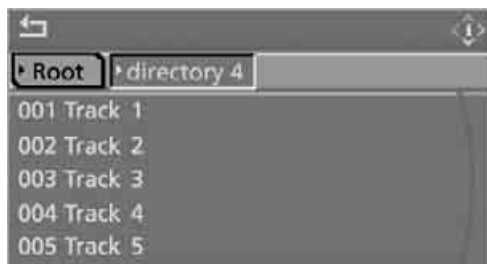

To exit from the menu:

Select the arrow and press the controller.

Displaying information on track*

With compressed audio files, you can display possibly included information about the current track, e.g. the name of the artist.

1. Press the controller.
2. Select "Details" and press the controller.



The information about the current track is displayed.

From radio readiness, the setting for the remote control used at the moment is saved.

Sampling tracks, scan

The system automatically plays a brief sample from each of the tracks on the current CD.

1. Select "Set" and press the controller.
Other menu items are displayed.



2. Select "Scan" and press the controller.



To end sampling:

1. Press the controller.
2. Select "Scan" and press the controller.

This cancels sampling of the tracks, and the player remains on the current track.

Compressed audio files*

1. Select the current track and press the controller.
2. Select the desired menu item:
 - ▶ To sample all tracks of the current directory, select "Scan directory" and press the controller.
 - ▶ To sample all tracks of the CD, select "Scan all" and press the controller.



To end scan search:

1. Press the controller.
2. Select "Scan directory" or "Scan all" and press the controller.

This cancels the scan search and the player remains on the current track.

Repeating track

1. Select "Set" and press the controller.
Other menu items are displayed.



2. Select "Repeat" and press the controller.



The current track on the CD is repeated.

To cancel repeat mode:

1. Press the controller again.
2. Select "Repeat" and press the controller.

Compressed audio files*

1. Select the current track and press the controller.
2. Select the desired menu item:
 - ▷ To repeat the selected track, select "Repeat track" and press the controller.
 - ▷ To repeat all tracks of the current directory, select "Repeat directory" and press the controller.



To cancel repeat mode:

1. Press the controller.
2. Select "Repeat track" or "Repeat directory" and press the controller.

Random play sequence

In this mode, the tracks on the current CD are played once in a random sequence.

1. Select "Set" and press the controller. Other menu items are displayed.
2. Select "Random" and press the controller.

To cancel random mode:

1. Press the controller.
2. Select "Random" and press the controller.

Compressed audio files*

1. Select the current track and press the controller.
2. Select the desired menu item:
 - ▷ To play all tracks of the current directory in random order, select "Random directory" and press the controller.
 - ▷ To play all tracks of the CD in random order, select "Random all" and press the controller.

To cancel random mode:

1. Press the controller.
2. Select "Random directory" or "Random all" and press the controller.

Fast forward/reverse

Buttons next to CD player:

Press and hold the ◀▶ button for the corresponding direction.

CD magazine

The BMW CD changer for six CDs is installed in the glove compartment.

Removing CD magazine

To insert CDs into the CD magazine 1 or remove them from it, you must first remove the magazine from the CD changer:

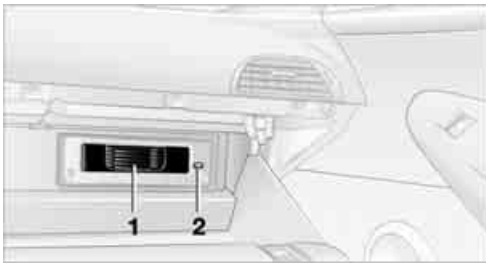

Press button **2** to eject the CD magazine **1**.
Wait at least 2 seconds before pushing in the magazine again so that the inserted CDs can be read in again.

Inserting/removing CDs into/from CD magazine

When inserting or removing CDs, remember to hold them only by their edges, taking care to avoid touching the reflective CD memory surface.

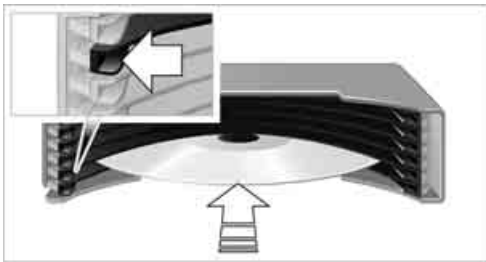

To insert:
Insert one CD into each compartment of the magazine with the labeled side up.



To remove:
Pull out the desired tray and remove the CD.

Inserting CD magazine

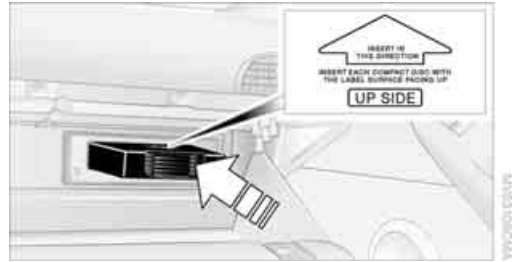

Push in the CD magazine as far as possible in the direction of the arrow.

The CD changer automatically reads in the inserted CDs and is then ready for operation.

Notes

- !** BMW CD/DVD players and changers are officially designated Class 1 laser products. Do not operate if the cover is damaged, otherwise severe eye damage can result. Do not use self-recorded CDs with adhesive labels as these can come loose during playback due to heat build-up and cause irreparable damage to the system.
- Only use round CDs/DVDs with a standard diameter of 4.7 in/12 cm and do not play CDs/DVDs with an adapter, e.g. Single-CDs, otherwise the CDs or the adapter can jam and may no longer be ejected.
- Do not use a combined CD/DVD, e.g. DVD^{Plus}, otherwise, the CD/DVD can jam and will no longer eject. ◀

General malfunctions

BMW CD/DVD changers and players have been optimized for performance in vehicles. In some instances they may be more sensitive to faulty CDs/DVDs than stationary devices would be.

If a CD/DVD cannot be played, first check whether it has been inserted correctly.

Humidity

High levels of humidity can lead to condensation on the CD/DVD or the laser's scan lens and temporarily prevent playback.

Malfunctions with individual CDs/DVDs

If malfunctions occur only with particular CDs/DVDs, this can be due to one of the following causes.

Home-recorded CDs/DVDs

Possible reasons for malfunctions with self-recorded CDs/DVDs are, e.g., inconsistent data-creation or recording processes, or poor quality or advanced age of the CD/DVD blank.

Label CDs/DVDs only on the top, using a marker designed for this purpose.

Damaged CDs/DVDs

Avoid fingerprints dust, scratches, and moisture.

Keep CDs/DVDs in a sleeve.

Do not subject CDs/DVDs to temperatures over 122 °F /50 °C, high levels of humidity or direct sunlight.

CDs/DVDs with copy protection

Manufacturers often provide CDs/DVDs with copy protection. This can mean that some CDs/DVDs cannot be played or can only be played to a limited extent.

Care

If necessary, clean the reflective scanning side of the CDs/DVDs with a commercially available cleaning cloth by wiping in straight lines from the center outward.

AUX-In connection

You can connect an external audio device, e.g. an MP3 player, and play the sound via the vehicle loudspeakers. The sound can be adjusted via iDrive.

4. Select "AUX" and press the controller.
5. Adjust volume and sound if necessary.

Connecting

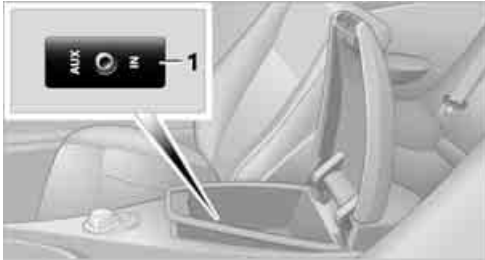

For audio playback via the vehicle loudspeakers, connect the headphones or the line-out connection of the device to the socket **1** with a 1/8 in/3,5 mm jack plug.

Starting audio playback

The audio device must be switched on.

1. Press the **MENU** button.
This opens the start menu.
2. Move the controller backwards to call up "Entertainment".
3. Change to upper field if necessary. Turn the controller until "AUX" is selected and press the controller.





Communications

This chapter summarizes how to operate your mobile phone using iDrive or voice control and how to use BMW Assist or TeleService.

Telephoning*

The concept

Your BMW is equipped with a full mobile phone preparation package. After a suitable mobile phone has been paired in the vehicle once, you can operate the mobile phone via iDrive, with the buttons on the steering wheel and by voice.

A mobile phone that has been paired once is automatically detected again as soon as it is brought back inside the vehicle, provided that the engine is running or the ignition is switched on. The pairing data of up to four mobile phones can be stored simultaneously. If several mobile phones are detected simultaneously, the most recently paired mobile phone can be operated via the vehicle.

Using a phone in your vehicle

Using snap-in adapter*

The so-called snap-in adapter, a mobile phone cradle, enables the battery to be charged and the mobile phone to be connected to the external antenna of your vehicle. This ensures improved network reception and a consistent voice reproduction quality. Ask your BMW center which mobile phones will fit in the snap-in adapters they offer.

 BMW discourages the use of mobile phones or other mobile communications devices inside the vehicle without a direct connection to an outside antenna. Otherwise, the vehicle electronics and mobile communication device can interfere with each other. In addition, there is no assurance that the radiation that results from transmission will be dissipated from the vehicle interior. ◀

For your safety

A car phone makes life more convenient in many ways, and can even save lives in an emergency. While you should consult your mobile phone's separate operating instructions for a detailed description of safety precautions and information, we request that you direct your particular attention to the following:

 Only make entries when the traffic situation allows you to do so. Do not hold the mobile phone in your hand while you are driving; use the hands-free system instead. If you do not observe this precaution, your being distracted can endanger vehicle occupants and other road users. ◀

Suitable mobile phones

Ask your BMW center which mobile phones with a Bluetooth interface are supported by the mobile phone preparation package or which mobile phones will fit in the snap-in adapters they offer. These mobile phones support the functions described in this Owner's Manual, provided they are running a certain software version. Malfunctions can occur with other mobile phones.

Care instructions

You can find what you need to know about caring for your mobile phone in the separate Caring for your vehicle brochure and in the mobile phone operating instructions.

Operating options

You can operate the mobile phone* using:

- ▷ Buttons on steering wheel, refer to page 11
- ▷ iDrive, refer to page 16
- ▷ Voice commands, refer to page 181

A mobile phone detected by the vehicle should not be operated by the mobile phone's keypad; otherwise malfunctions may occur.

Placing phone calls with BMW Assist system*: BMW Assist calls

You can use the BMW Assist system via the hands-free unit for BMW Assist calls.

When the status information "BMW Assist" or "BMW Service" is displayed in "Communication", only BMW Assist calls are possible.

It may not be possible to establish a telephone connection using the mobile phone while a connection is being established to BMW Assist or while a call to BMW Assist is already in progress. If this happens, you must unpair the mobile phone and the vehicle if you wish to place a call with the mobile phone.

Initial operation

Pairing mobile phone in vehicle

The following prerequisites must be met:

- ▷ Suitable mobile phone: the mobile phone is supported by the full mobile phone preparation package. Information on this subject is also provided on the Internet at: www.bmw.com
- ▷ The mobile phone is ready to operate.
- ▷ The Bluetooth links of the vehicle, refer to page 175, and the mobile phone are active.
- ▷ Depending on the mobile phone, presets in the mobile phone are required: e.g. via the following menu items:
 - ▷ Bluetooth activated
 - ▷ Connection not with confirmation
 - ▷ Reconnect

- ▷ Depending on the mobile phone model, the setting energy saving mode can, for example, result in vehicle failing to detect the paired mobile phone.
- ▷ Specify any desired number as the Bluetooth passkey, e.g. 1, for pairing. This Bluetooth passkey is no longer required following successful pairing.
- ▷ The ignition is switched on.



Only pair the mobile phone with the vehicle stopped; otherwise you may become distracted and inadvertently endanger your passengers and other road users. ◀

Switching on ignition

1. Insert the remote control as far as possible into the ignition lock.
2. Switch on the ignition by pressing the Start/Stop button without depressing the brake or clutch pedal.

Preparation with iDrive

iDrive, for explanation of principle, refer to page 16.

3. Press the **MENU** button to open the start menu.



4. Press the controller to open the **i** menu.

5. Select "Settings" and press the controller.



6. Select "Bluetooth" and press the controller.



7. Change into the second field from the top, select "Phone" and press the controller.



8. Select "Pair new phone" and press the controller.



9. Select "Start pairing" and press the controller.



The Bluetooth name of the vehicle is displayed.

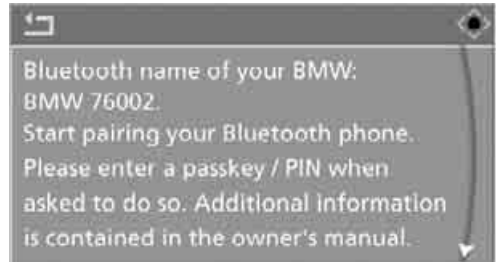

Preparation with mobile phone

10. Additional operations must be carried out on the mobile phone and differ depending on the model, refer to the operating instructions of your mobile phone, e.g. find, connect or pair under Bluetooth device. The Bluetooth name of the vehicle is also shown on the mobile phone display.
11. Select the Bluetooth name of the vehicle on the mobile phone display.

Pairing

Depending on your mobile phone, you will first be requested consecutively via the display of your mobile phone or iDrive to enter the Bluetooth passkey you specified.

12. Enter the Bluetooth passkey.
Depending on the mobile phone, approx. 30 seconds are available for entering the Bluetooth passkey on the mobile phone and on the Control Display.

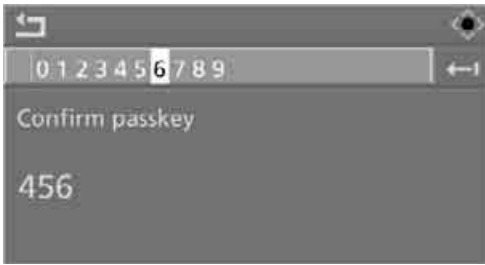

13. Change into the third field from the top, select "Confirm passkey" and press the controller.
14. Wait a few seconds until the "Communication" menu appears.

The next time you use the mobile phone in the vehicle interior, it will be detected within a maximum of 2 minutes with the engine running or the ignition switched on.

 With some mobile phone models it may be necessary to make certain settings for a permanent Bluetooth link, e.g. via the menu item Authorization or Secure connection. Refer to the operating instructions of your mobile phone. ◀

As soon as a mobile phone is detected by the vehicle, the phone book entries stored on the SIM card or on your mobile phone are transmitted to your vehicle. This transmission is dependent on your mobile phone, refer to the operating instructions of your mobile phone if necessary, and can take several minutes.

If not all phone book entries are displayed:

- ▷ Transfer all phone book entries from the SIM card to the mobile phone if necessary.
- ▷ It may not be possible to display phone book entries with special characters.

Up to four mobile phones can be paired consecutively. When you pair a fifth mobile phone, the pairing data of the mobile phone for which the pairing data were stored first in the vehicle will be deleted.

Check if pairing is unsuccessful

- ▷ Is the mobile phone supported by the mobile phone preparation package? Information on this subject is also provided on the Internet at: www.bmw.com.
- ▷ Do the Bluetooth passkey on the mobile phone and the vehicle match? The same Bluetooth passkey must be entered both on the mobile phone display and via iDrive.
- ▷ Have you required longer than 30 seconds to enter the Bluetooth passkey?
- ▷ Only a limited number of devices can be connected to the mobile phone. Delete the connection to other devices if necessary.
- ▷ The mobile phone no longer reacts? Switch the mobile phone off and then on again or disconnect the power supply.

To repeat pairing:

1. Select "Restart pairing" and press the controller.

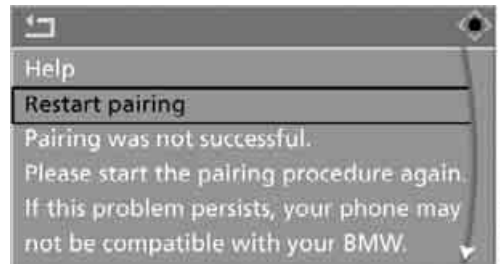

2. Repeat steps 9 to 14.

If pairing was repeatedly unsuccessful, contact the BMW Hotline.

To call the BMW Hotline:

Select "Help" and press the controller.

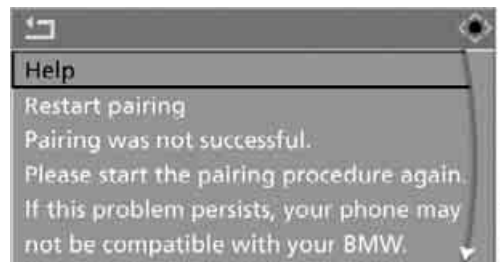

The phone number of the BMW Hotline and information required for pairing is shown on the display. With mobile phones already paired, you can select the phone number of the BMW Hotline to establish the connection.



List of paired mobile phones

The mobile phones for which the vehicle has stored the pairing data can be displayed. If several paired mobile phones are detected by the vehicle simultaneously, you can operate the mobile phone highest up in the list via the vehicle.

You can change the order of the mobile phones in the list. As long as a mobile phone is selected in this list, the mobile phones cannot be operated via the vehicle.

iDrive, for explanation of principle, refer to page 16.

1. Press the **MENU** button to open the start menu.
2. Press the controller to open the **i** menu.
3. Select "Settings" and press the controller.
4. Select "Bluetooth" and press the controller.
5. Change into the second field from the top, select "Phone" and press the controller.
6. Select the desired mobile phone.

With two drives:

- ▷ Move the controller to the rear to change into the bottom field.
- ▷ Select the desired mobile phone and press the controller.

With a single drive:

- ▷ Select the desired mobile phone and press the controller.



7. Select "Move device up" and press the controller.



The selected mobile phone is moved upward by one position.

Unpairing mobile phone from vehicle

If you no longer want to operate a mobile phone via the vehicle, you can delete the pairing data of the mobile phone.

iDrive, for explanation of principle, refer to page 16.

1. Switch off the mobile phone.
2. Press the **MENU** button to open the start menu.
3. Press the controller to open the **i** menu.
4. Select "Settings" and press the controller.
5. Select "Bluetooth" and press the controller. "Bluetooth" is selected.
6. Change into the second field from the top, select "Phone" and press the controller.
7. Select the desired mobile phone.

With two drives:

- ▷ Move the controller to the rear to change into the bottom field.
- ▷ Select the desired mobile phone and press the controller.

With a single drive:

- ▶ Select the desired mobile phone and press the controller.

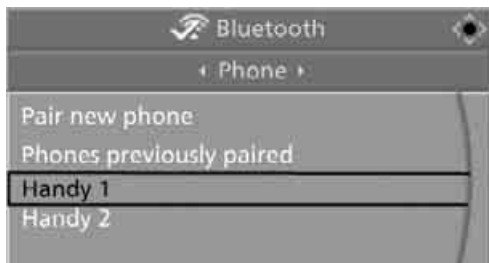

- 8. Select "Delete device" and press the controller.



The unpaired mobile phone is deleted from the list.

The phone book entries and the lists of stored phone numbers are also deleted.

Activating/deactivating Bluetooth link

▶ Bluetooth technology is not approved in all countries. Observe the applicable local regulations. Temporarily deactivate the Bluetooth link between the vehicle and the mobile phone if necessary.

If the Bluetooth link is deactivated, you cannot operate your mobile phone via the vehicle and the mobile phone can use other devices with a Bluetooth interface, e.g. a laptop computer. ◀

To temporarily deactivate the Bluetooth link between your vehicle and your mobile phone:

1. Remove the mobile phone from the cradle and switch it off.
2. Press the **MENU** button to open the start menu.
3. Press the controller to open the **i** menu.

4. Select "Settings" and press the controller.
5. Select "Bluetooth" and press the controller.



- 6. Change into the second field from the top, select "Settings" and press the controller.

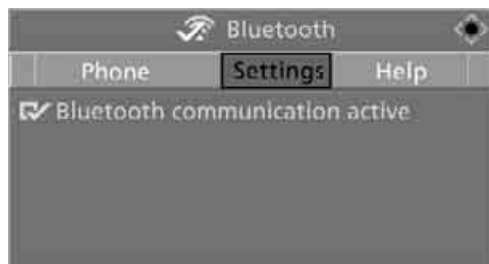

- 7. Select "Bluetooth communication active" and press the controller to activate or deactivate the link.

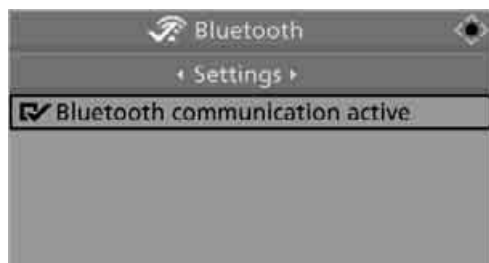

- The Bluetooth link is activated.
- The Bluetooth link is deactivated.

Adjusting volume



Turn the knob during a call to select the desired volume.

This volume for the hands-free system is maintained, even if the other audio sources are set to minimum volume.

You can also adjust the volume with the buttons on the steering wheel, refer to page 11.

The setting is stored for the remote control currently in use.

Operation via iDrive

You can operate the following functions via iDrive:

- ▷ Accepting/rejecting a call
- ▷ Dialing phone numbers
- ▷ Dialing phone numbers from the phone book
- ▷ Dialing stored phone numbers, e.g. from the list of accepted calls
- ▷ Ending a call

When the ignition and radio readiness are switched off, e.g. after removing the remote control from the ignition lock, you can continue an ongoing call via the hands-free system for no more than 25 minutes.

Speech quality

If the person you are talking to cannot understand you well, this may be due to excessively loud background noises. The full mobile phone preparation package can compensate for these noises to a certain degree. To optimize the

speech quality during a call, we recommend that you:

- ▷ Reduce background noises, e.g. by closing the windows, reducing the air volume of the automatic climate control or pointing the opened front vent outlets downward.
- ▷ Reduce the volume of the hands-free system.

Requirements

- ▷ The pairing data of the mobile phone are stored in the vehicle and the mobile phone is ready to operate.
- ▷ The engine is running or the ignition is switched on.
- ▷ The mobile phone is detected by the vehicle.

Opening Communication

You operate many of the functions described in the following via the "Communication" menu.

iDrive, for explanation of principle, refer to page 16.

1. Press the **MENU** button to open the start menu.



2. Move the controller forward to open "Communication".

Receiving calls

If you have the phone number of the caller stored in the phone book and the phone number has been transmitted, the name of the entry is displayed.

Accepting a call

Press the  button on the steering wheel.

Alternative:

"Accept" is selected.

Press the controller.

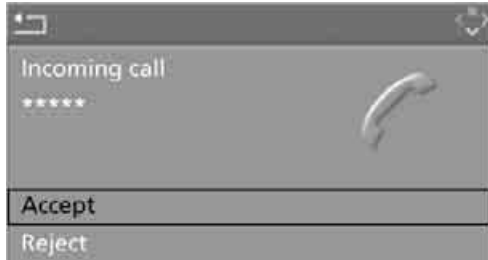

Rejecting a call

Select "Reject" and press the controller.

The caller is diverted to your mailbox if it has been activated.

Calling

Dialing phone numbers

1. Select "Phone" and press the controller.



2. Select "Dial" and press the controller.
3. Enter the desired phone number by dialing the individual digits and pressing the controller.

Always enter the complete phone number consisting of national dialing code, area code, and phone number.

The letters correspond to the digits on the keypad of the mobile phone.

To delete the last digit:

Move the controller toward the right to select the arrow  and press the controller down.

4. Select "Dial number" and press the controller.

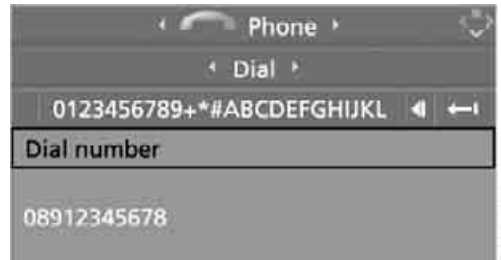

Alternative:

Press the  button on the steering wheel.

For your phone number to be displayed to the person you are calling, the display of phone numbers must be enabled by your service provider.

Ending call

Press the  button on the steering wheel.

Alternative:

1. Select the phone number and press the controller.



- "End call" is selected:
Press the controller.



Dialing a phone number from phone book or a phone number stored in a list

Phone numbers you have called, incoming calls and the entries of the phone book are stored in lists when the mobile phone is connected to the vehicle via Bluetooth. If the caller is entered in the phone book, the name of the entry is displayed instead of the phone number.

You can select the desired subscriber from the list and establish the connection.

Five lists are available:

- ▷ "A - Z"
The entries of the mobile-phone phone book, consisting of the name and phone number, are sorted alphabetically.
- ▷ "Top 8"
The eight numbers called most frequently from the phone book "A - Z" are automatically stored in the Top 8 list.
- ▷ "Redial"
The last eight phone numbers you have dialed are automatically stored. The last number dialed is at the top of the list.
- ▷ "Missed calls"
The phone numbers of the last eight calls which were not accepted are stored. This requires the telephone number of the caller to have been sent.
- ▷ "Received calls"
The phone numbers of the last eight accepted calls are stored. This requires the telephone number of the caller to have been sent.

Dialing phone numbers from phone book

The list "A - Z" is available for you phone book entries. The phone book entries appear on the Control Display.

- Select "Phone" and press the controller.



- Select "A - Z" and press the controller.
- To limit the number of displayed entries, select the first letter of the desired entry and press the controller.
- Select the desired entry and press the controller.

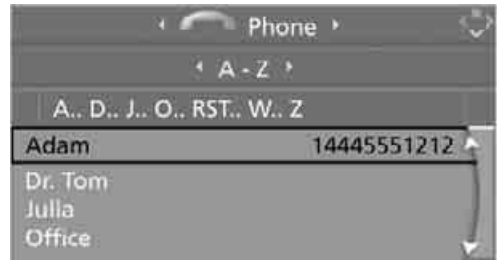

- Select "Call" and press the controller.
The system dials the number.

If different phone numbers are stored in the mobile phone under one name, e.g. office and home, the name is shown once for each phone number.

You can change a phone number stored in the phone book, e.g. to call a specific extension:

- Select "Phone" and press the controller.
- Select "A - Z" and press the controller.
- Select the desired entry and press the controller.
- Select "Add digits" and press the controller.

5. Change the phone number.
6. Select "Dial number" and press the controller.

Dialing a phone number stored in a list

To select an entry and establish a connection:

1. Select "Phone" and press the controller.
2. Select list and press the controller:
 - ▷ "Top 8"
 - ▷ "Redial"
 - ▷ "Missed calls"
 - ▷ "Received calls"



3. Select the desired entry and press the controller.



4. Select "Call" and press the controller.
The system dials the number.

Deleting individual entries

1. Select the desired entry from the list and press the controller.
2. Select "Delete" and press the controller.



The entry is deleted.

Deleting entire list

1. Select an entry from the list and press the controller.
2. Select "Delete all numbers" and press the controller.



3. If applicable, select "Yes" and press the controller.
The list is deleted.

BMW Contact*

If you have not enabled BMW Assist, you can have several service numbers displayed:

- ▷ Roadside Assistance* of the BMW Group when you require breakdown assistance
- ▷ BMW center, e.g. when you want to make an appointment for service
- ▷ BMW Customer Relations* for information on all aspects of your vehicle

If BMW Assist is enabled, refer to page 185.

You can dial the displayed service phone numbers if your mobile phone is paired in the vehicle:

iDrive, for explanation of principle, refer to page 16.

1. Press the **MENU** button.
This opens the start menu.
2. Move the controller forwards to select "Communication".
3. Select "BMW Contact" and press the controller.



4. Select "BMW Contact Numbers" and press the controller.



5. Select one of the following menu items and press the controller:
 - ▷ "Roadside Assistance"
 - ▷ "Customer Relations"
 - ▷ "Service Request"
6. Select "Call" and press the controller.
Contact is established.

Transferring phone number via tone dialing method

The tone dialing method is required for access to network services or for controlling devices, e.g. remote checking of an answering machine.

This function is available when a connection has been established.

1. Establish connection.



2. With a single drive:
Press the controller.
Select "Keypad" and press the controller.
With two drives:
Move the controller backwards until the bottom field is selected.
3. Select the desired character and press the controller.
Each character is sent immediately and confirmed by a tone depending on the mobile phone model.



Changing between mobile phone and hands-free system

From mobile phone to hands-free system

You can continue calls begun outside the Bluetooth range of the vehicle via the hands-free system when the engine is running or the ignition is switched on. Depending on your mobile phone, the system automatically switches over to the hands-free mode.

For mobile phones that do not automatically switch over to the hands-free mode:

- ▷ Depending on the mobile phone model used, the conversation can be continued via the hands-free system if necessary. Follow the instructions displayed on the mobile phone display, refer to the operating instructions of your mobile phone.
- ▷ Press the  button above the storage compartment. Switching over may take several seconds.

From hands-free system to mobile phone

When you telephone via the hands-free system, you can also continue the call via the mobile phone if necessary, depending on the mobile phone model. Act according to what is shown on the mobile phone display, refer to the operating instructions of your mobile phone.

As an alternative, you can deactivate the Bluetooth link.

Depending on your mobile phone model, poor reception of the wireless communications network can result in the system switching from the hands-free system to the mobile phone.

Operation by voice*

The concept

You can operate your mobile phone without having to remove your hands from the steering wheel. When making your entries, you will be supported by announcements or questions in many cases.

The same prerequisites as for operation via iDrive apply, refer to page 176.

Voice commands

Activating system

1. Briefly press the  button on the steering wheel.
An acoustic signal indicates that you can say commands.
2. Say the command.

Ending/canceling operation by voice

Press the  button on the steering wheel or

 ›Cancel‹.

In dialogs where text is spoken, not a command, e.g. a name, canceling is only possible using the button on the steering wheel.

Having possible commands read aloud

The system understands default commands that must be spoken word for word. You can have the system read aloud the possible commands at any point:

 ›Help‹.

Using alternative commands

There are often a number of commands to run a function, e.g.:

 ›Dial name‹ or ›Name‹.

The system recognizes digits from zero to nine. You can say each digit individually or group them into a sequence to accelerate the input.

Example: dialing phone numbers

Start the dialog:

Press the  button on the steering wheel.

You say	The voice control answers
›Dial number‹	››Please say the number‹‹
e.g. ›123 456 7890‹	Depending on equipment: ››123 456 7890. Continue?‹‹ or ››123 456 7890. And next?‹‹
›Dial‹	››Dialing number‹‹

Setting volume of instructions

You can adjust the volume for the instructions from the system:



Turn the knob during instructions.

This volume for the instructions is maintained, even if the other audio sources are set to minimum volume.

The setting is stored for the remote control currently in use.

Calling

Dialing phone numbers

1. ›Dial number‹.
2. Say the phone number.
For telephone calls abroad, say ›Plus‹ and then the country code.
3. ›Dial‹.

The connection to the desired subscriber is established.

Correcting phone number

After the last spoken sequence of digits has been repeated by the system, you can delete this sequence of digits.

- ›Correct number‹.
The digits are deleted.

The command ›Correct number‹ can be repeated as often as you like.

Deleting phone number

- ›Delete‹

All digits entered up to this point are deleted.

Voice phone book

Operating by voice requires a personal voice phone book.

- ▷ With combined drives for audio CDs and navigation DVDs, the entries are automatically adopted from your mobile phone's memory.
- ▷ With a single drive, the entries must be entered by voice and are independent of your mobile phone's memory. In this case, it is not possible to use voice command either to call phone numbers stored in the mobile phone or to store new numbers.

Creating and editing voice phone book*

Save entry:

An entry always consists of a name and phone number.

1. ›Save name‹.
2. Say the name.
The spoken length of the names in the phone book must not exceed approx. 2 seconds.
3. Say the phone number after being requested to do so by the system.
4. To store the phone number:
›Save‹.

Delete entry:

You can delete any entry from the voice phone book.

1. ›Delete name‹.
The dialog for deleting an entry is opened.
2. Say the name when prompted.
3. Confirm the prompt with ›Yes‹.

Delete all entries:

›Delete phone book‹ deletes all entries in the phone book.

1. ›Delete phone book‹.
The dialog for deleting phone book is opened.
2. Confirm the prompt with ›Yes‹.
3. Confirm the repeated prompt with ›Yes‹.

Have entries read aloud and dial:

You can have all the entries of your voice phone book read aloud in the order of input and select a certain entry to establish a connection:

1. ›Read phone book‹.
The dialog for reading phone book is opened.
2. ›Dial number‹ when the desired entry is read aloud.

Selecting an entry

The connection to the phone number of the selected entry is established.

1. ›Dial name‹.
The dialog for selecting an entry is opened.
2. Say the name when prompted.
3. Confirm the prompt with ›Yes‹.

Redialing

The ›Redial‹ command calls up "Redial".

Notes

Important for voice commands

For voice commands, keep the following in mind:

- ▷ Issue the commands smoothly and at normal volume, avoiding excessive emphasis and pauses.
- ▷ Keep the doors and windows closed to prevent interference from ambient noise.
- ▷ Avoid making other noise in the vehicle while speaking.

Mounting/removing snap-in adapter

1. Press the area **1** around the button and remove the cover.

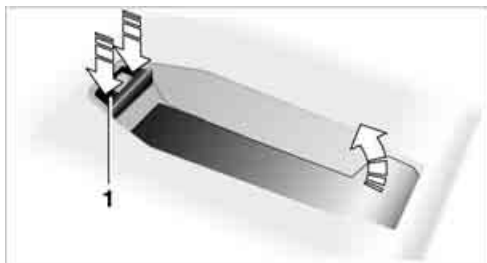

2. Insert the snap-in adapter at the front and press down until it engages.



To remove the snap-in adapter:
Press the area 1 around the button.

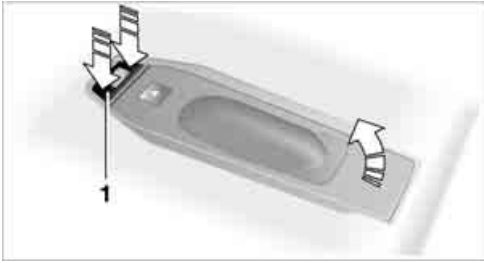

Inserting mobile phone

1. Remove the protective cap from the mobile phone's antenna connector if necessary, so that the mobile phone can engage in the snap-in adapter.
2. With the buttons facing upward, press the mobile phone toward the electrical connections and press down until it engages.

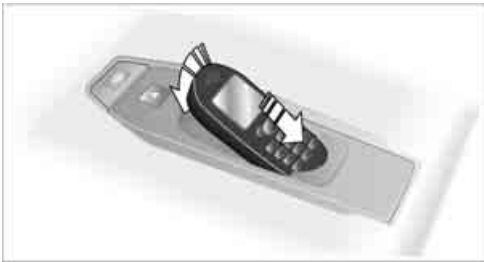

From radio readiness or with the steering unlocked the mobile phone's battery is charged.

 To protect the vehicle's batteries, avoid using the phone when the ignition is switched off. ◀

Removing mobile phone

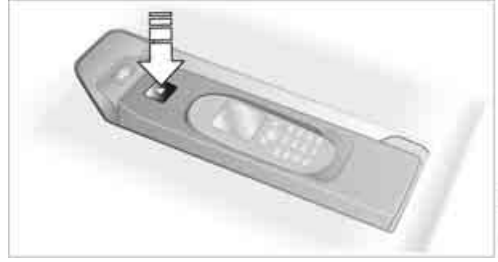

Press button.

BMW Assist provides you with various services. For example, the position data of your vehicle can be transmitted to the BMW Assist Response Center if an emergency call* has been initiated.

Many BMW Assist services depend on the individually agreed contract.

After your contract has expired, the BMW Assist system will be deactivated by the BMW Assist Response Center without you having to visit a BMW center. Following the deactivation of the BMW Assist systems, no BMW Assist service is available. The BMW Assist system be reactivated by a BMW center after signing a new contract.

Requirements

You can use BMW Assist when the following requirements are met:

- ▶ The installed BMW Assist system is logged in on a mobile phone network. This network must be capable of transmitting the services.
- ▶ To transmit position data, the vehicle must be able to determine the current position.
- ▶ A GPS signal must be available in order for BMW Assist to be activated and updated.
- ▶ You have placed an order for the BMW Assist service contract at a BMW center or BMW Assist Response Center and signed the service contract. Enabling must have been completed.
- ▶ BMW Assist is activated, refer to page 190.

Services offered

The following services are available via BMW Assist:

- ▶ **Emergency call, refer to page 219:**
When you press the SOS button, a connection is established to the BMW Assist Response Center. The BMW Assist Response Center contacts you and arranges for further steps to help you.
- ▶ **Automatic emergency call:**
Under certain conditions a connection is established to the BMW Assist Response Center directly following a serious accident. If possible, the BMW Assist Response Center then contacts you and arranges for further steps to help you.
- ▶ **Roadside Assistance:**
You can call Roadside Assistance* of the BMW Group should you require help in the event of a breakdown. If possible, the vehicle and position data are transmitted in the process.
- ▶ **BMW Customer Relations:**
For information related to your vehicle, call BMW Customer Relations.
- ▶ **TeleService:**
Data on your vehicle's service status or necessary inspections are transmitted to your BMW center either automatically before a service due date or when you request a BMW service appointment.
- ▶ **Unlocking vehicle:**
Inform the BMW Assist Response Center, e.g. if your remote control is not available and you want to have the vehicle unlocked.
- ▶ **Vehicle search:**
After your vehicle has been reported to the police as stolen, the BMW Assist Response Center can locate its position. To do this, the vehicle electronics must be ready for operation.

In addition, you can be provided with other services, e.g. the information service or information on route planning, the traffic situation and the weather.

Press the SOS button to contact the BMW Assist Response Center, see below.

You also have access to the BMW Assist information service via the Internet.

Special features of services offered

The following special features apply to the services:

- ▷ The services offered are country-specific.
- ▷ Voice contact is established or data are transferred, depending on the equipment and the country. In some countries, it is possible to do both.
- ▷ The data transmitted can, for example, be the vehicle data, your current position or the data of the CBS Condition Based Service.

Using services

Contacting BMW Assist Response Center

You can contact the BMW Assist Response Center with the SOS button.

1. Briefly press protective cover to open.
With some vehicle equipment packages or in the Convertible, the arrangement of the switches and indicator lamps may differ somewhat.



2. Press the button for at least 2 seconds.
The BMW Assist Response Center is contacted.

Breakdown assistance

iDrive, for explanation of principle, refer to page 16.

1. Press the **MENU** button.
This opens the start menu.



2. Move the controller forwards to select "Communication".
3. Change to upper field if necessary. Turn the controller until "BMW Assist" is selected and press the controller.

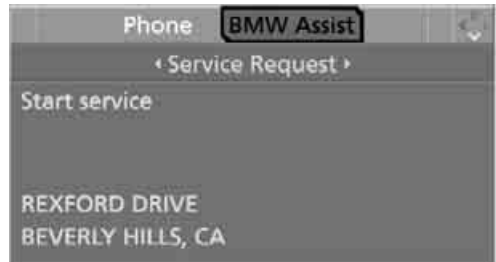

4. Select "Roadside Assistance" and press the controller.

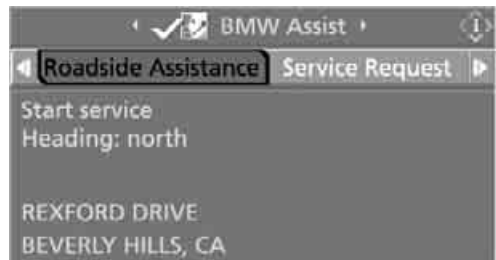

If the location can be determined, the current vehicle position is displayed.

5. Select "Start service" and press the controller.

The BMW Assist Response Center will connect you to the Roadside Assistance of the BMW Group.

TeleService

Automatic service notification*

The data on the service status of your vehicle or on necessary inspections is transmitted automatically prior to the due date. You can check when the BMW center was notified.

1. Press the **MENU** button.
This opens the start menu.
2. Press the controller to open the **i** menu.
3. Select "Info sources" and press the controller.



4. Select "Service" and press the controller.
5. Change to upper field if necessary. Turn the controller until "Service requirements" is selected and press the controller.

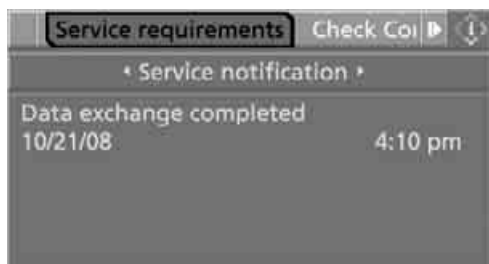

6. Select "Service notification" and press the controller.

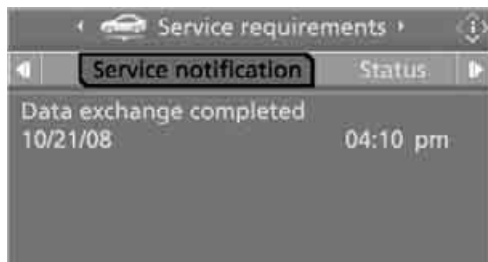

Manual service notification

You can transmit data on the service status of your vehicle to your BMW center if you want to make an appointment for service.

1. Press the **MENU** button.
This opens the start menu.
2. Move the controller forwards to select "Communication".
3. Change to upper field if necessary. Turn the controller until "BMW Assist" is selected and press the controller.

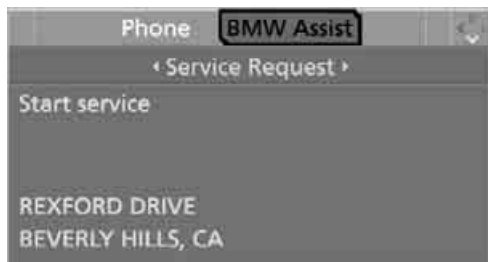

4. Select "Service Request".

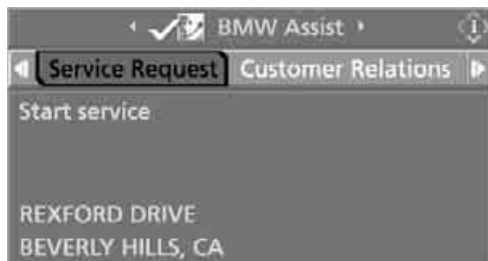

5. Press the controller.
6. Select "Start service" and press the controller.

The data relevant for service are transmitted. Your BMW center will contact you to set up an appointment for service.

Contacting BMW Customer Relations

For information on all aspects of your vehicle, you can contact BMW Customer Relations.

1. Press the **MENU** button. This opens the start menu.
2. Move the controller forwards to select "Communication".
3. Change to upper field if necessary. Turn the controller until "BMW Assist" is selected and press the controller.



4. Select "Customer Relations".

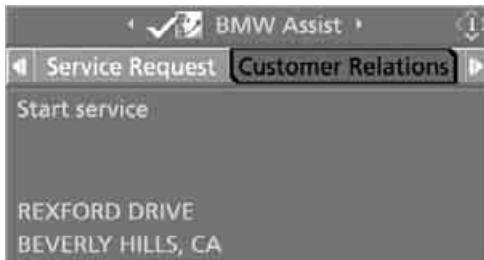

5. Press the controller.
6. Select "Start service" and press the controller.

You are connected to BMW Customer Relations by the BMW Assist Response Center.

Information service*

When you call the information service of BMW Assist, you can, for example, obtain information on current events, filling stations or hotels and have their phone numbers and addresses transmitted. Reservations can be made at many hotels directly by the BMW information service.

The information service must be enabled separately by the BMW Assist Response Center.

Calling up information

1. Press the **MENU** button. This opens the start menu.
2. Move the controller forwards to select "Communication".
3. Change to upper field if necessary. Turn the controller until "BMW Assist" is selected and press the controller.



4. Select "Concierge" and press the controller.



5. Select "Start Service" and press the controller.

The BMW Assist Response Center will connect you to the information service.

Displaying transmitted data

Select the received message if necessary and press the controller.



Dialing phone number or adopting address in destination guidance

1. Select "Options" and press the controller.



2. Select a menu item:
 - ▶ With "Call" you can establish a telephone connection. This requires your Bluetooth mobile phone to be paired in the vehicle.
 - ▶ With "Select as destination" you can adopt the address in the destination guidance of the navigation system.

Updating BMW Assist

Displaying and updating services

You will be notified of any changes in the services offered by BMW Assist. In this case you should update the services.

1. Press the **MENU** button.
This opens the start menu.
2. Press the controller to open the **i** menu.

3. Turn the controller until "Settings" is selected and press the controller.



4. Turn the controller until "BMW Service settings" is selected and press the controller.



5. Change to upper field if necessary. Turn the controller until "Service Status" is selected and press the controller.
The current services available from BMW Assist are displayed.
6. If applicable, select "Options" and press the controller.



7. Select "Update services" and press the controller.

Blocking services*

If you block the services, the connection to BMW Assist is deactivated.

1. Press the **MENU** button.
This opens the start menu.
2. Press the controller to open the **i** menu.
3. Turn the controller until "Settings" is selected and press the controller.
4. Turn the controller until "BMW Service settings" is selected and press the controller.



5. Change to upper field if necessary. Turn the controller until "Service Status" is selected and press the controller.
6. Select "Options" and press the controller.



7. Select "Terminate services" and press the controller.

The use of BMW Assist is blocked, and the current vehicle position will not be transmitted during an emergency call*. To cancel blocking and reactivate BMW Assist, see below. This does not affect the contractual agreements.

Reactivate BMW Assist if necessary to log on again.

Activating BMW Assist

For you to be able to use the services of BMW Assist, BMW Assist must be activated.

Requirements

- ▷ Make sure that the vehicle can determine its current position. Reception is best when you have an unobstructed view to the sky.
- ▷ Leave radio readiness switched on while connecting to the system.

Activating

1. Press the **MENU** button.
This opens the start menu.



2. Press the controller to open the **i** menu.
3. Turn the controller until "Settings" is selected and press the controller.



- Turn the controller until "BMW Service settings" is selected and press the controller.



- Change to upper field if necessary. Turn the controller until "Service Status" is selected and press the controller.



- Select "Enable services" and press the controller. BMW Assist is activated and the data exchange with the BMW Assist Response Center begins.



Activation takes a few minutes. The status is displayed on the Control Display. If you open another menu, the activation process continues to run in the background.

Displaying vehicle data

When BMW Assist is activated, the license plate and the vehicle identification number of your vehicle can be displayed.

- Open the start menu.
- Press the controller to open the **i** menu.
- Select "Settings" and press the controller.



- Select "BMW Service settings" and press the controller.



- Change to upper field if necessary. Turn the controller until "Profile" is selected and press the controller.









Mobility

This section helps you maintain your mobility by supplying important information on vital topics including fuels and lubricants, wheels and tires, service, maintenance and breakdown assistance.

Refueling

 Switch off the engine before refueling, otherwise no fuel can be filled into the tank and a message is displayed. ◀

 When handling fuel, always observe all applicable precautionary measures and regulations. Never transport reserve fuel containers in the vehicle. They can leak and cause an explosion or a fire in an accident. ◀

Fuel filler door



To open and close: briefly press the rear edge of the fuel filler door.

Unlocking manually

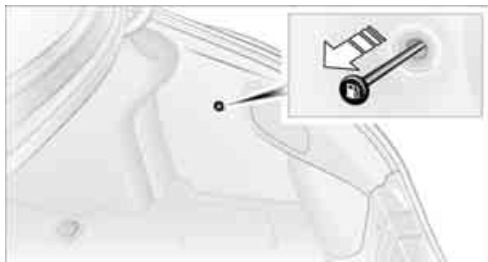

In the event of an electrical malfunction, you can release the fuel filler door manually:

In the luggage compartment, pull the knob with the gas pump symbol on the right side panel.

Observe the following when refueling

 When handling fuels always follow any safety guidelines posted at the gas station. ◀



Place the fuel filler cap in the bracket attached to the fuel filler door.

When refueling, insert the filler nozzle completely into the filler pipe. Avoid raising the filler nozzle during refueling, otherwise this

- ▷ results in premature pump shutoff
- ▷ can lead to reduced efficiency in the fuel-vapor recovery system

The fuel tank is full when the filler nozzle clicks off the first time.

Fuel tank capacity

Approx. 18.5 US gal/70 liters, including the reserve capacity of approx. 4 US gal/15 liters.

 Refuel as soon as possible once your cruising range falls below 30 miles/ 50 km, otherwise engine functions are not ensured and damage can occur. ◀

Fuel filler cap

Closing

Insert the cap and turn it clockwise until there is a clearly audible click.

 Do not jam the strap attached to the fuel filler cap between the fuel filler cap and the vehicle. A message* is displayed if the cap is loose or missing. ◀

Fuel specifications

 Never use leaded gasoline; it will permanently damage the catalytic converter. Do not use E85, i.e. fuel that consists of 85% ethanol, or Flex Fuel. Otherwise permanent damage to the engine and the fuel supply system will result. ◀

Required fuel

Super Premium Gasoline/AKI 93

Always use this premium grade fuel to obtain maximum fuel economy and performance.

The minimum approved fuel grade is AKI 91.

 Do not use gasoline below the specified minimum quality, otherwise engine damage can result. ◀

Use high-quality brands

Field experience has demonstrated significant differences in fuel quality: volatility, composition, additives, etc., among gasolines offered for sale in the United States and Canada. Fuels containing up to and including 10% ethanol or other oxygenates with up to 2.8% oxygen by weight, that is, 15% MTBE or 3% methanol plus an equivalent amount of co-solvent, will not void the applicable warranties with respect to defects in materials or workmanship.

 The use of poor-quality fuels may result in problems relating to drivability and starting, and to a tendency to stall, especially under certain environmental conditions such as high ambient temperature and high altitude. Should you encounter drivability problems which you suspect could be related to the fuel you are using, we recommend that you respond by switching to a recognized high-quality brand such as gasoline that is advertised as Top Tier Detergent Gasoline. Failure to comply with these recommendations may also result in unscheduled maintenance. ◀

Wheels and tires

Tire inflation pressure

Information for your safety

The condition of the tires and the maintenance of the specified tire pressure are crucial not only to the tire's service life, but also to driving comfort and most importantly, driving safety.

Checking pressure

Only check tire inflation pressure when the tires are cold. This means after a maximum of 1.25 miles/2 km driving or when the vehicle has been parked for at least 2 hours. When tires are warm, the tire inflation pressure increases.

 Check the tire inflation pressure regularly and correct if necessary, including on the spare wheel*: at least twice a month and before starting long trips. Otherwise, driving instability or tire damage, and therefore accidents, can result from incorrect tire inflation pressures. ◀

 After correcting the tire inflation pressure, reinitialize the Flat Tire Monitor, refer to page 85, or reset the Tire Pressure Monitor, refer to page 87. ◀

Pressure specifications

The tables below provide all the correct inflation pressures for the specified tire sizes at ambient temperature.

 The inflation pressures apply to the tire sizes and tire brands respectively approved and recommended by BMW; a list of these is available from your BMW center. ◀

For correct identification of the right tire inflation pressure for your tires, observe the following:

- ▷ Tire sizes for your vehicle
- ▷ Load conditions
- ▷ Maximum allowable driving speed

Tire inflation pressures for driving up to 100 mph/160 km/h

For normal driving up to 100 mph/160 km/h, adjust pressures to the respective tire inflation pressures listed on the following pages in the column for traveling speeds up to a max. of 100 mph/160 km/h to achieve optimum driving comfort.

These pressure specifications can be found on the door post when you open the driver's door.





 The permissible top speed for these tire inflation pressures is 100 mph/160 km/h. Do not exceed this speed; otherwise, tire damage and accidents may result. ◀

Tire inflation pressures for driving above 100 mph/160 km/h

 In order to drive at maximum speeds in excess of 100 mph/160 km/h, please note the tire pressures for speeds exceeding 100 mph/160 km/h listed in the relevant column of the table on the following pages and adjust your tire inflation pressures as needed. Otherwise, tire damage and accidents could occur. ◀



Observe all national and local maximum speed limits, otherwise violations of the law could occur.

Tire inflation pressures for M6 Coupe

Tire size	Pressure specifications in psi/kPa					
	Traveling speeds up to max. of 100 mph/160 km/h		Traveling speeds including those exceeding 100 mph/160 km/h			
All pressure specifications in the table are indicated in psi/kilopascal with cold tires. Cold = ambient temperature						
	245/45 R 18 100 V XL M+S	35/240	38/260	35/240	38/260	41/280 46/320
	255/40 ZR 19	33/230	-	33/230	-	41/280 -
	285/35 ZR 19	-	36/250	-	36/250	- 46/320

More details on the permissible load and weights can be found on page [228](#).

Tire inflation pressures for M6 Convertible

Tire size	Pressure specifications in psi/kPa					
	Traveling speeds up to max. of 100 mph/160 km/h		Traveling speeds including those exceeding 100 mph/160 km/h			
All pressure specifications in the table are indicated in psi/kilopascal with cold tires. Cold = ambient temperature						
	245/45 R 18 100 V XL M+S	35/240	38/260	35/240	38/260	41/280 46/320
	255/40 ZR 19	32/220	-	32/220	-	41/280 -
	285/35 ZR 19	-	35/240	-	35/240	- 46/320

More details on the permissible load and weights can be found on page [228](#).

Tire identification marks

Knowledge of the labeling on the side of the tire makes it easier to identify and choose the right tires.

Tire size

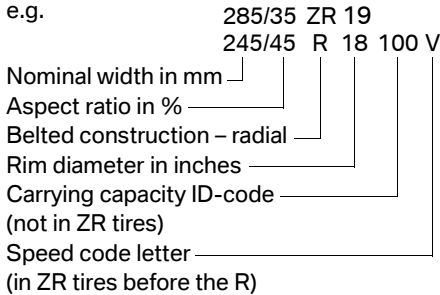

Speed letter

- T = up to 118 mph/190 km/h
- H = up to 131 mph/210 km/h
- V = up to 150 mph/240 km/h
- W = up to 167 mph/270 km/h
- Y = up to 186 mph/300 km/h
- Z = over 150 mph/240 km/h

Tire Identification Number

Tires with DOT codes meet the guidelines of the US Department of Transportation.

DOT code:

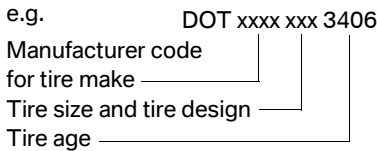

Tire age

The tire's date of manufacture is indicated on the sidewall:

DOT ... 3406 indicates that a tire was manufactured in week 34 of the year 2006.

BMW recommends replacing all tires at least every 6 years, even if some tires may last for

10 years. This also concerns the tire of the spare wheel*.

Uniform Tire Quality Grading

Quality grades can be found where applicable on the tire sidewall between tread shoulder and maximum section width. For example:

Tread wear 200 Traction AA
Temperature A

DOT Quality Grades

Tread wear
Traction AA A B C
Temperature A B C



All passenger car tires must conform to Federal Safety Requirements in addition to these grades. ◀

Tread wear

The tread wear grade is a comparative rating based on the wear rate of the tire when tested under controlled conditions on a specified government test course.

For example, a tire graded 150 would wear one and one-half, 1½, times as well on the government course as a tire graded 100. The relative performance of tires depends upon the actual conditions of their use, however, and may depart significantly from the norm due to variations in driving habits, service practices and differences in road characteristics and climate.

Traction

The traction grades, from highest to lowest, are AA, A, B, and C.

These grades represent the tire's ability to stop on wet pavement as measured under controlled conditions on specified government test surfaces of asphalt and concrete. A tire marked C may have poor traction performance.



The traction grade assigned to this tire is based on straight-ahead braking traction tests, and does not include acceleration, cornering, hydroplaning, or peak traction characteristics. ◀

Temperature

The temperature grades are A, the highest, B, and C, representing the tire's resistance to the generation of heat and its ability to dissipate heat when tested under controlled conditions on a specified indoor laboratory test wheel. Sustained high temperature can cause the material of the tire to degenerate and reduce tire life, and excessive temperature can lead to sudden tire failure. The grade C corresponds to a level of performance which all passenger car tires must meet under the Federal Motor Vehicle Safety Standard No. 109. Grades B and A represent higher levels of performance on the laboratory test wheel than the minimum required by law.

 The temperature grade for this tire is established for a tire that is properly inflated and not overloaded. Excessive speed, underinflation, or excessive loading, either separately or in combination, can cause heat buildup and possible tire failure. ◀

M+S

Winter and all-season tires. These have better winter properties than summer tires.

XL

Indicates specially reinforced tires.

Tire condition

Inspect your tires frequently for tread wear, signs of damage and foreign objects lodged in the tread, and check the tread depth.

Minimum tread depth

The tread depth should not drop below 0.12 in/ 3 mm, although, for example, European legislation only specifies a minimum tread depth of 0.063 in/1.6 mm. At tread depths below 0.12 in/ 3 mm, there is an increased risk of high-speed hydroplaning, even when only small amounts of water are present on the road surface. Winter tires noticeably lose their suitability for winter use below a tread depth of 0.16 in/4 mm.

New tires should be mounted in the interest of safety.

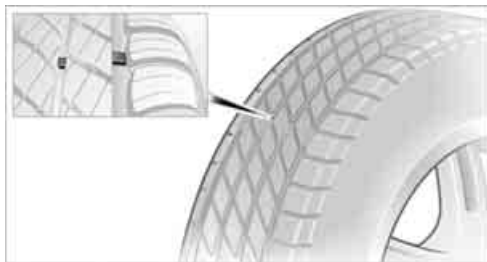

Wear indicators at the tread-groove base, refer to arrow, are distributed over the tire's circumference and are marked on the side of the tire with TWI – Tread Wear Indicator. If the tire tread has been driven down to the wear indicators, a tread depth of 0.063 in/1.6 mm has been reached.

Wheel/tire damage

Please note that low-profile tires cause wheels, tires and suspension parts to be more susceptible to road hazards and consequential damages.

Unusual vibrations encountered during normal vehicle operation can indicate tire failure or some other vehicle defect. This can, for example, be caused by driving over curbs. These kinds of problems may also be signaled by other changes in vehicle response, such as a strong tendency to pull to the left or right.

 In these cases reduce your speed immediately and have the wheels and tires inspected immediately. To do this, carefully drive to the nearest BMW center or a specialized tire dealer that works in accordance with BMW guidelines and uses appropriately trained personnel. Have the vehicle towed to the repair shop if necessary. Tire damage can be extremely dangerous to vehicle occupants and other road users. ◀

New wheels and tires

! Only have new wheels and tires mounted by a BMW center or a repair shop that works in accordance with BMW guidelines and uses appropriately trained personnel. If this work is performed inexpertly, there is a danger of damage and associated safety risks. Make sure that the new wheels are balanced. ◀

Retreaded tires

! BMW does not recommend the use of retreaded tires; otherwise, driving safety may be reduced. Potentially substantial variations in the design and the age of the carcasses can result in a reduced service life. ◀

The right wheels and tires

! BMW recommends that you use only wheel and tire combinations that BMW has tested and approved for your particular vehicle. Variations in factors such as manufacturing tolerances mean that even wheels and tires with identical official size ratings could actually have different dimensions than the approved units – these differences could lead to body contact, and with it the risk of severe accidents. When selecting the tires, also ensure that they have a sufficient load-carrying capacity. If non-approved wheels and tires are used, BMW cannot evaluate their suitability, and therefore cannot be held liable for driving safety. ◀

You can find out the right wheel-tire combination from your BMW center.

The right wheel-and-tire combination is another vital factor in ensuring reliable operation of various vehicle systems such as ABS and DSC.

To maintain good handling and vehicle response, use only tires of a single tread configuration from a single manufacturer. After a tire is damaged, always remember to have the original wheel and tire combination remounted on the vehicle as soon as possible.

Wheels with electronics for TPM Tire Pressure Monitor

When mounting new tires or converting from summer to winter tires or vice versa, only use wheels with TPM electronics, otherwise the Tire Pressure Monitor cannot detect a flat tire, refer to page 86. Your BMW center will be happy to advise you on this subject.

Recommended tire brands

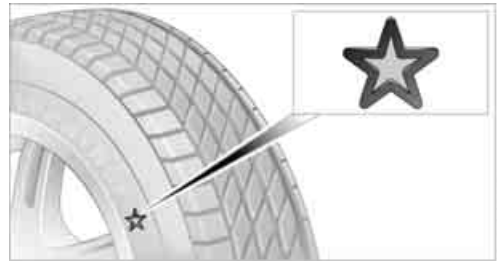

BMW recommends particular tire brands for each tire size. You can recognize these from the clearly visible BMW marking on the tire sidewall. With proper use, these tires meet the highest standards for safety and handling characteristics.

Special characteristics of winter tires

BMW recommends winter tires for use in cold winter driving conditions. Although all-season M+S tires provide better winter traction than summer tires, they generally fail to provide the same levels of cold-weather performance as winter tires.

Watch speed

! Always observe the maximum permissible speed for the winter tires, otherwise tire damage may occur, which can result in accidents. ◀

After changing wheels/tires

After changing tires or wheels, the slip detection of the Sequential Manual Transmission must become familiar with the changed state.

Reinitialize the system for this purpose:

1. Move the selector lever into the idling position N on a straight stretch of road at a speed between 20 mph/30 km/h and 90 mph/150 km/h.
2. Pull both shift paddles for approx. 2 seconds.

If you do not carry out initialization, the system will automatically learn the changed state gradually during driving. This may be noticeable from the clutch opening and closing briefly.

Storage

Store wheels and tires in a cool, dry place with as little exposure to light as possible. Always protect tires against all contact with oil, grease and fuels. Do not exceed the maximum tire inflation pressure indicated on the side wall of the tire.

Rotating wheels between axles

BMW does not recommend moving the front wheels to the rear or vice versa, as otherwise the handling characteristics may be impaired.

Snow chains*

BMW only tests certain fine-link snow chains, classifies them as road-safe and recommends them. Consult your BMW center for more information.

Use is only permitted in pairs, with winter tires of the size 245/45 R 18 on the rear wheels.

Observe the manufacturer's instructions when mounting snow chains. Do not exceed a speed of 30 mph/50 km/h with the chains mounted.

Make sure that the snow chains are always sufficiently tensioned. Retension in accordance with the chain manufacturer's specifications if necessary.



Do not initialize the Flat Tire Monitor after installing snow chains as this could cause the Flat Tire Monitor to malfunction.

After mounting or removing snow chains, the slip detection of the Sequential Manual Transmission must become familiar with the altered state. To do this, reinitialize the system, refer to After changing wheels/tires. ◀

Under the hood

⚠ Never attempt to perform any service or repair operations on your vehicle without the required professional technical training. If you are unfamiliar with the specifications to be observed, only have work carried out on your vehicle by a BMW center or a repair shop that works in accordance with BMW guidelines and uses appropriately trained personnel. Otherwise, there is a danger of damage and associated safety risks if this work is performed improperly. ◀

Hood

Releasing



Pull lever.

Opening

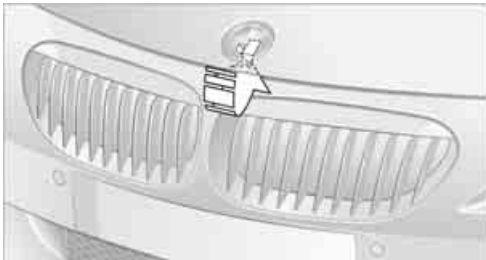

Press the release handle and open the hood.

▷ You cannot start off with the hood open. ◀

Closing

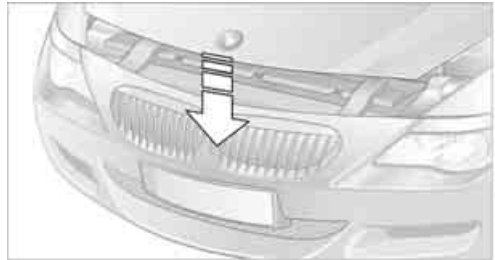

Close the hood from a height of approx. 16 in/ 40 cm with momentum. It must be clearly heard to engage.

⚠ Make sure that the closing path of the hood is clear; otherwise, injuries may result.

If you see any signs that the hood is not completely closed while you are driving your vehicle, you should stop at once and close it securely. ◀

Engine compartment

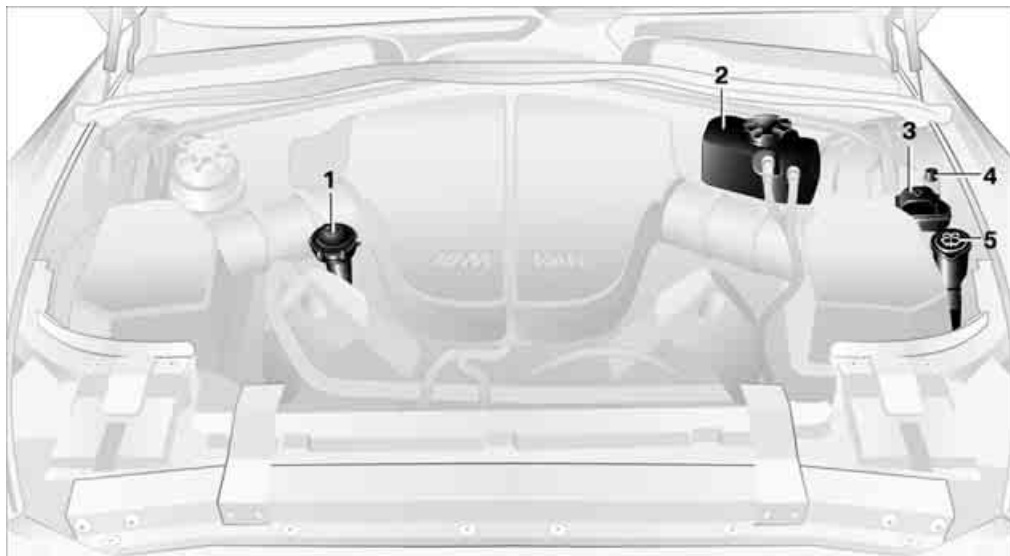

- 1 Filler neck for engine oil, refer to Adding engine oil
- 2 Expansion tank for coolant, refer to page 205
- 3 Jump-starting terminal, refer to page 220
- 4 Body ground/negative terminal
- 5 Filler neck for washer fluid of the headlamp and windshield cleaning systems, refer to page 66

Engine oil

Engine oil consumption depends on driving style and driving conditions.

Checking engine oil level

Your vehicle is equipped with an electronic oil level check. You can display the oil level in the instrument cluster.



- 1 Oil level
- 2 Maximum marking
- 3 Minimum marking

Press the BC button in the turn signal lever repeatedly until the oil level display is shown in the instrument cluster. The displayed numeric value indicates the current oil level in liters above Minimum.

After starting the engine, the last determined value is displayed.

The oil level must be between the two marks.

 Manual transmission: the fluid level will be shown in the lower display. ◀

Exact measurement

The oil level is measured continuously while driving or when stopped with the engine running.

The determination of a new value can take 30 minutes or longer.

 If only dashes are shown in the display, it was not possible to determine a new value. This can, for example, be the case when driving short distances or with a sporty driving style. ◀

Fast measurement

In addition to the continuous measurement, you can also quickly determine the current oil level, e.g. after adding engine oil, however with a low measuring accuracy.

1. With the engine at operating temperature, i.e. after at least 6 miles/10 km of uninterrupted driving, park the vehicle in a horizontal position.
2. Allow the engine to run at idle.
3. Press the BC button in the turn signal lever repeatedly until the oil level display is shown in the instrument cluster.
4. Press the BC button in the turn signal lever for at least 2 seconds.

The oil level is determined. A clock symbol is displayed during the measurement.

5. After approx. 1 minute the current oil level is displayed.

 If not all measuring conditions are met, e.g. with the engine cold, "-.-" is displayed. The requested measurement is carried out as soon as possible. ◀

Possible displays

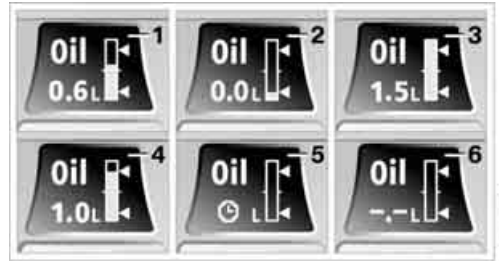

- 1 Oil level OK
- 2 Oil level at minimum:
Add a maximum of 1 US quart/1 liter of engine oil at the next opportunity, refer to Adding engine oil below
- 3 Oil level is too high
 Have the vehicle checked immediately; otherwise, engine damage may result if too much oil has been added. ◀
- 4 Oil level at maximum
- 5 Fast measurement running: oil level is being determined
- 6 No value can be determined at this time

Adding engine oil

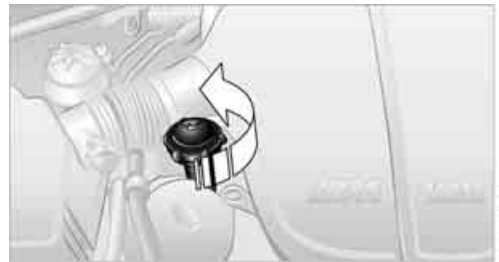

Do not add oil until a value slightly above the minimum of 0.0 US quarts/liters is displayed by the oil level measurement. In this area a message is also shown on the Control Display.

 Add oil within the next 125 miles/200 km, otherwise the engine could be damaged. Add a maximum of 1 US quart/1 liter of oil, otherwise the engine may be damaged by adding too much oil.

Add at least 0.5 US quart/0.5 liter of oil, otherwise the oil level check cannot reliably display the current oil level. ◀

 Please conduct a quick measurement after adding engine oil to check the oil quantity added and to update the display. ◀

 Continuous exposure to used oil has caused cancer in laboratory testing. For this reason, thoroughly wash exposed areas of skin with soap and water after such work. Keep oil, grease, etc. out of reach of children and observe warnings on containers. Failure to do so could pose health risks. ◀

Oil change

Have oil changes carried out only by a BMW center or a repair shop that works in accordance with BMW guidelines and uses appropriately trained personnel.

Approved engine oils

The quality of the engine oil selected has critical significance for the operation and service life of an engine. BMW continuously approves specific oils after confirming their suitability for use in its vehicles with extensive testing.

 Do not use oil additives; under some circumstances, they can damage your engine. ◀

 Your BMW center will be happy to answer detailed questions on BMW High Performance Synthetic Oil or approved synthetic oils. ◀

You can also call BMW of North America at 1-800-831-1117 or visit the website at www.bmwusa.com to obtain this information.

Viscosity grades

The viscosity is a measure of the thickness of the oil and is specified in SAE grades.

 Approved oils belong to the SAE grade 10W-60. ◀

Alternative oil types

If BMW High Performance Synthetic Oil is unavailable, you can add small quantities of other synthetic oils between oil changes. Only use oils with the following specifications:

- ▷ Viscosity
preferred: SAE 10W-60;
alternative: SAE 10W-40, SAE 5W-50 or SAE 10W-50
- ▷ Specification
API SJ/CF, API SK/CF or higher

Low ambient temperatures

The oils used by BMW from the factory for your vehicle model can be used at virtually all ambient temperatures. However, if the vehicle is operated for a longer period at temperatures below -4°F / -20°C , your BMW center will be happy to recommend a suitable oil.

BMW recommends 

Coolant

 Do not open the cooling system when the engine is hot. Escaping coolant can cause burns. ◀

Coolant consists of water and coolant additive. Not all commercially available additives are suitable for your BMW. Ask your BMW center for suitable additives.

 Only use suitable additives, otherwise engine damage may result. The additives present a health hazard. ◀

 Always observe all applicable environmental laws and regulations when disposing of used coolant additives. ◀

Checking coolant level

1. Allow the engine to cool.
2. Turn the cap of the expansion tank counterclockwise to allow any accumulated pressure to escape, then continue turning to open.

3. The coolant level is correct when the upper end of the float rod is at the same height as the upper edge of the filler neck, also refer to the drawing next to the filler neck.



4. If the coolant is low, slowly add coolant up to the specified level – do not overfill.
5. Turn the cap until it clicks.
6. Have the reason for the coolant loss eliminated as soon as possible.

Maintenance

BMW Maintenance System

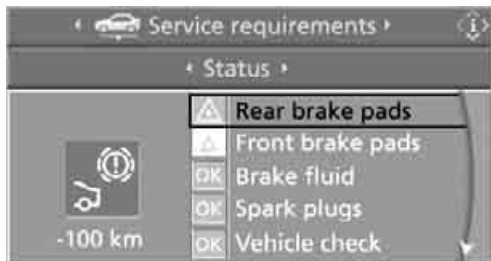

The BMW Maintenance System supports the preservation of the traffic and operating safety of your BMW. The service schedule also includes operations related to the vehicle's comfort and convenience features, such as replacement of the filters for the inside air. The ultimate objective is to ensure economical maintenance by providing the ideal service for your vehicle.

Should the day come when you decide to sell your BMW, you will find that a complete dealer service history is an asset of inestimable value.

CBS Condition Based Service

Sensors and special algorithms take the different driving conditions of your BMW into account. Condition Based Service uses this to determine the current and future service requirements. By letting you define a service and maintenance regimen that reflects your own individual requirements, the system builds the basis for trouble-free driving.

You can set the Control Display to show remaining distances and times of selected maintenance intervals and legally mandated deadlines, refer to page 71:

- ▷ Engine oil
- ▷ Brake pads, front and rear separately
- ▷ Microfilter/activated-charcoal filter
- ▷ Brake fluid
- ▷ Spark plugs

- ▷ Vehicle check
- ▷ Legally required tests depending on local regulations

Service data in remote control

Your vehicle stores the information required for maintenance continuously in the remote control during driving. After accessing the data stored in the remote control, your BMW Service Advisor can suggest precisely the right array of service procedures for your own individual vehicle. For this reason, when you take your vehicle in for service, you should give the BMW Service Advisor the remote control last used to drive it.

 Make sure the date is set correctly, refer to page 78, otherwise the effectiveness of CBS Condition Based Service is not ensured. ◀

Service and Warranty Information Booklet for US models and Warranty and Service Guide Booklet for Canadian models

Please consult your Service and Warranty Information Booklet for US models and Warranty and Service Guide Booklet for Canadian models for additional information on service requirements.

 BMW recommends that you have service and repair operations performed at your BMW center.

Take the time to ensure that these service procedures are confirmed by entries in your vehicle's Service and Warranty Information Booklet for US models and Warranty and Service Guide Booklet for Canadian models. These entries verify that your vehicle has received the specified regular maintenance. ◀

Socket for OBD Onboard Diagnostics interface



Components which are decisive for the exhaust-gas composition can be checked via the OBD socket with a device.

This socket is located under a cover on the left side of the driver's footwell, directly under the instrument panel.

Exhaust-gas values



The warning lamp lights up. The exhaust-gas values are deteriorating. Have the vehicle checked as soon as possible.



Display of the previously described malfunction on Canadian models.

The lamp flashes under certain conditions. This is a sign of excessive misfiring of the engine. In this case, you should reduce speed and drive to the nearest BMW center as soon as possible. Heavy engine misfiring causes serious damage to the emission-relevant components, especially the catalytic converter, within a short time.



If the fuel filler cap is not properly tightened, the OBD system can detect the escape of fuel vapor. This causes a display to light up. If the cap is then tightened, the display should go out within a few days. ◀

Event data recorders

Your vehicle may be equipped with one or several measuring and diagnosis modules, or with a device for recording or transmitting certain vehicle data or information. If you have also subscribed to a BMW Assist plan, then certain vehicle data can be transmitted or recorded to enable corresponding services.

Care

Important information on care and maintenance of your BMW is contained in the Caring for your vehicle brochure.

Replacing components

Onboard tool kit



The onboard tool kit is located in the luggage compartment under the floor mat.

Replacing wiper blades

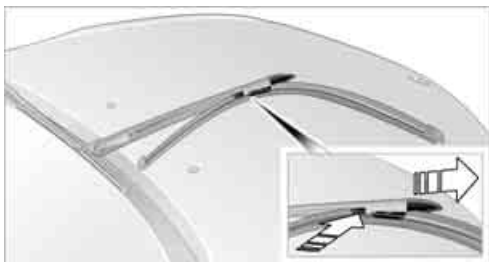

1. Fold the wiper arm out and grasp it firmly.
2. Press the locking tabs together while sliding the wiper blade toward the front to disengage it.
3. Insert the new wiper blade and slide it in until it audibly clicks into place.

Lamps and bulbs

Lamps and bulbs make an essential contribution to driving safety. You must be duly diligent in replacing them. If you are not familiar with the specified procedures, have the corresponding work carried out at your BMW center.

⚠ Never touch the glass on new bulbs with your bare fingers, as even minute amounts of contamination will burn into the bulb's surface and reduce its service life. Use a clean cloth, napkin, etc., or hold the bulb by its metal socket. ◀

A selection of replacement bulbs is available at your BMW center.

⚠ Whenever you perform any work on the electrical system, turn off the electrical devices involved to prevent short circuits from occurring. To avoid possible injury or equipment damage when replacing bulbs, follow any instructions provided by the bulb manufacturer. ◀

When performing maintenance on the headlamps, follow the instructions in the separate Caring for your vehicle brochure.

⚠ For bulbs for which changing is not described, and for checking and adjusting headlamp aim, please contact your BMW center. ◀

Light-emitting diodes LEDs

Light-emitting diodes installed behind translucent lenses serve as the light source for many of the controls and displays in your vehicle. These light-emitting diodes, which operate using a concept similar to that applied in conventional lasers, are officially designated as Class 1 light-emitting diodes.

⚠ Do not remove the covers, and never stare into the unfiltered light for several hours, as irritation of the retina could result. ◀

Xenon lamps

The service life of these lamps is very long and the probability of a failure is very low, provided that they are not switched on and off an unusual number of times.

⚠ Have work on the xenon lighting system performed only by your BMW center or a workshop that works according to BMW repair procedures with correspondingly trained personnel. Due to the high voltage involved, there is a danger to life and limb when work is carried out improperly. ◀

High beams, parking lamps

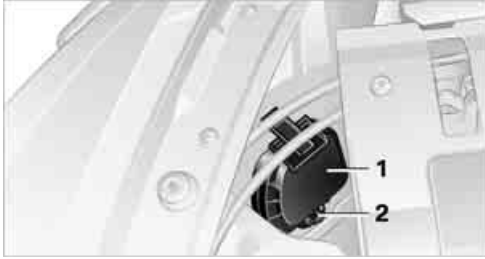

The illustration shows the front left side of the engine compartment.

High beams

55-watt bulb, H 7

1. Remove the cover cap **1** by pressing the tab and removing the cover cap upward.
2. Press the bulb holder from above to release it.
3. Remove the bulb holder.
4. Remove and replace the bulb.

⚠ The lamp H7 is pressurized; wear eye protection and protective gloves. Otherwise, there is a danger of injuries if the bulb is accidentally damaged during replacement. ◀

Parking lamps

10-watt bulb

▷ Bulb holder and reflector are one unit and are replaced together. ◀

1. Turn the bulb holder **2** to the right and remove.
2. Press the snap connection on the plug connector, pull off the bulb holder and replace.

Front turn signals, side marker lamps

Your BMW is equipped with two turn signal lamps per side in the front.

Turn signal lamp 1

21-watt bulb, WY21SV

The illustration shows the front right side of the engine compartment.

1. Press the lever shown:
 - ▷ downward for the right turn signal
 - ▷ upward for the left turn signal



2. Remove the bulb holder towards the rear.
3. Remove and replace the bulb.

Turn signal lamp 2

21-watt bulb, WY21SV

The bulb for the turn signal lamp 2 can be replaced via the wheel well.

The illustration shows the front left side of the vehicle.

1. Steering turned all the way to the left or right.
2. Turn off the light, switch off the ignition and remove the remote control from the ignition lock.

- Unscrew the bolt **1** with an open-ended wrench.

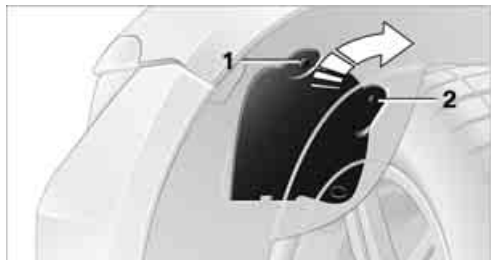

- Turn the cover around the rear securing point **2** upward while simultaneously pulling it out of the trim panel at the bottom.
- Turn the bulb holder to the left and remove, refer to arrow.



- Remove and replace the bulb.

Side marker lamps

5-watt bulb, WY5WST

The bulb can be replaced via a cover at the front of the wheel well, refer to the description for turn signal lamp 2.

- The bulb holder of the side marker lamp is located toward the outside of the vehicle next to the bulb holder of turn signal lamp 2.
- Turn the bulb holder to the left and remove.
- Remove and replace the bulb.

Side turn signals

5-watt bulb, WY5W

- Press against the front edge of the lamp with the tip of your finger, then push it to the rear, release the snap connection at the front and take it off the trim strip.

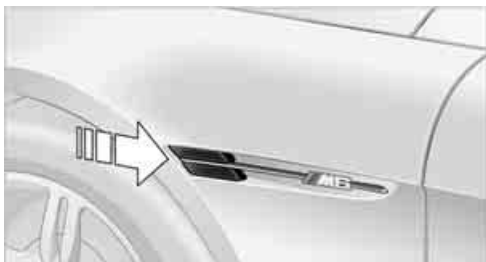

- Turn the bulb holder to the left by 90° and remove.
- Remove and replace the bulb.

Tail lamps

▶ The roadside parking, rear and brake lamps are LEDs. The backup lamps are equipped with long-life bulbs. Please contact a BMW center in case of a malfunction. ◀

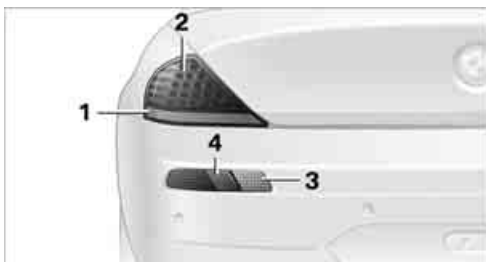

- Turn signals
- Roadside parking, tail and brake lamp
- Backup lamp
- Reflector

Rear turn signals



21-watt bulb, PY21W

The illustrations shows the left section of the luggage compartment.

1. Remove the cover.
2. Unclip the bulb holder and remove.
3. Apply gentle pressure to the bulb while turning it to the left for removal and replacement.

License plate lamps



5-watt bulb, W5W

1. Push a screwdriver from the left under the lamp and pry out the lamp toward the right.
2. Turn the bulb holder to the left by 90° and remove.
3. Remove and replace the bulb.

Repairing flat tire with M Mobility System

To repair a flat tire, an M Mobility System is provided in the BMW M6. Using this system you can apply a sealant in the inside of the tire, seal off the damaged area, restore the tire inflation pressure and then continue driving.

-  Safety measures in case of a breakdown:
 - 1. Park the vehicle as far as possible from passing traffic and on solid ground. Switch on the hazard warning flashers.
 - 2. Apply the handbrake and engage first gear or reverse gear with a manual transmission, or select a drive position with the selector level for a sequential transmission. Have all vehicle occupants get out of the vehicle and ensure that they remain outside the immediate area in a safe place, such as behind a guardrail.
 - 3. If a warning triangle* or portable hazard warning lamp* is required, set it up on the roadside at an appropriate distance from the rear of the vehicle. Comply with all safety guidelines and regulations. ◀

Preparation

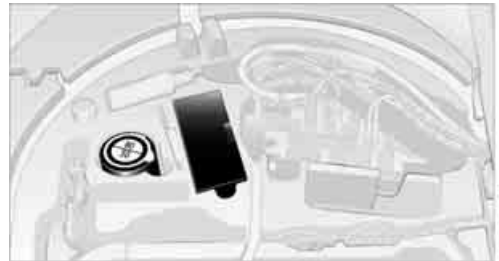

The M Mobility System is located in the luggage compartment under the floor panel flap. Do not remove foreign bodies which have penetrated the tire if possible.

-  Corresponding information on using the M Mobility System are also provided on the device. ◀

-  Before using the M Mobility System, observe the information on the sealant bottle. ◀

Pull the sticker for the speed limit off the sealant bottle and apply it to the steering wheel.

 Please observe the best-by date on the sealant bottle. ◀

The M Mobility System consists of



- 1 Sealant bottle and sticker with speed limit
- 2 Filling hose from sealant bottle to wheel

Model with pressure gauge on hose*

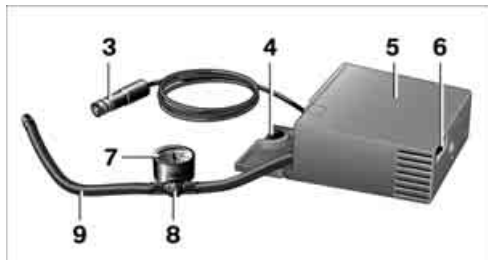

- 3 Connector and cable for lighter socket
- 4 Mounting for sealing bottle
- 5 Compressor
- 6 On/Off switch
- 7 Pressure gauge for indicating tire inflation pressure
- 8 Screw on pressure gauge for reducing tire inflation pressure
- 9 Connecting hose for connecting compressor and sealant bottle or compressor and wheel

Connector, cable and connecting hose are stored in the compressor housing.

Model with pressure gauge integrated in housing*

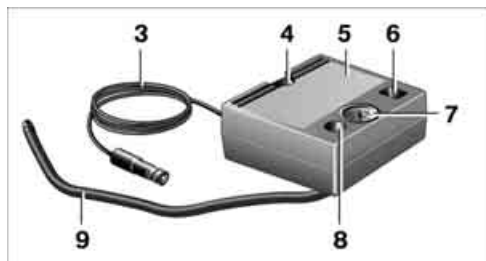

- 3 Connector and cable for lighter socket
- 4 Mounting for sealing bottle
- 5 Compressor
- 6 On/Off switch
- 7 Pressure gauge for indicating tire inflation pressure
- 8 Button for reducing tire inflation pressure
- 9 Connecting hose for connecting compressor and sealant bottle or compressor and wheel

Connector, cable and connecting hose are stored on underside of compressor.

Using M Mobility System

To repair a flat tire with the M Mobility System, proceed as follows:

- ▷ Fill sealant into wheel, refer to page 213.
- ▷ Distribute sealant, refer to page 214.
- ▷ Produce tire inflation pressure, refer to page 214.

Filling sealant into wheel

 Strictly comply with the specified order, otherwise highly pressurized sealant could escape. ◀

1. Shake sealant bottle.
2. Screw hose 9 onto connection of sealant bottle.
3. For model with pressure gauge on hose: Make sure that screw 8 on pressure gauge is closed.

4. Screw dust cap off valve of defective wheel and screw filling hose **2** of sealant bottle onto valve.
5. Insert sealant bottle on compressor housing so that it is positioned upright.

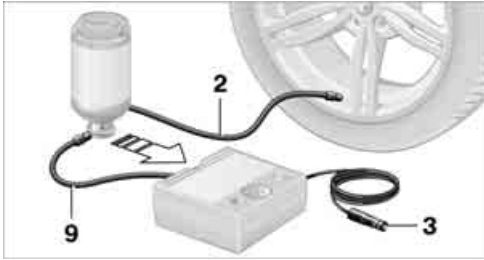

6. Make sure that device is switched off, position 0.
7. Insert connector **3** into lighter socket in vehicle interior, refer to page 108.
8. With the ignition switched on, refer to page 58:
Switch on the device and allow to run for approx. 3 minutes to fill wheel with sealant. It is not important what inflation pressure the tire has after filling.
9. Switch off device.
10. Remove connecting hose from connection of sealant bottle and tire valve.
Stow the M Mobility System in the vehicle again.

Distributing sealant

Immediately drive approx. 2 miles/3 km so that sealant is evenly distributed in tire.

- ▶ Do not exceed a maximum speed of 35 mph/60 km/h. Do not drop below 12 mph/20 km/h if possible. ◀

Producing tire inflation pressure

1. After approx. 2 miles/3 km, stop at suitable location.
2. Screw compressor hose **9** directly onto tire valve.
3. Insert connector **3** in lighter socket in vehicle interior.
4. Correct tire inflation pressure to 29 psi/200 kPa. With the ignition switched on:
 - ▶ Increase inflation pressure: switch on device, position I. To check currently set inflation pressure, briefly switch off device.

⚠ Do not allow compressor to run longer than 10 minutes, otherwise the device will overheat and may be damaged. ◀

- ▶ Reduce inflation pressure: press button **8** or turn screw **8** on pressure gauge.

▶ If the inflation pressure is not held, drive the vehicle again, refer to Distributing sealant. Then repeat steps 1 to 4 once. Using the M Mobility System can be ineffective with tire damage from a size of approx. 0.16 in/4 mm. Please contact the nearest BMW center, refer to page 220, or a workshop that works according to BMW repair procedures with correspondingly trained personnel if the tire cannot be made ready for driving with the M Mobility System. ◀

⚠ The tire inflation pressure must be at least 29 psi/200 kPa. Otherwise, do not continue driving. ◀

Continue driving

⚠ Do not exceed the permissible maximum speed of 50 mph/80 km/h, otherwise accidents can occur. ◀

- ▶ Reinitialize the Flat Tire Monitor. For details, refer to page 85.

Have the defective tire and the sealant bottle of the M Mobility System replaced as soon as possible. ◀

Changing wheels*

! Safety precautions in the event of a flat tire or wheel change: Park the vehicle as far as possible from passing traffic and on solid ground. Switch on the hazard warning flashers. Apply the handbrake and engage first gear or reverse gear with a manual transmission, or select a drive position with the selector level for a sequential transmission.

Have all vehicle occupants get out of the vehicle and ensure that they remain outside the immediate area in a safe place, such as behind a guardrail.

If a warning triangle* or portable hazard warning lamp* is required, set it up on the roadside at an appropriate distance from the rear of the vehicle. Comply with all safety guidelines and regulations.

Change the wheel only on a level, firm surface which is not slippery. The vehicle or the jack could slip to the side if you attempt to raise the vehicle on a soft or slippery surface such as snow, ice, tiles, etc.

Position the jack on a firm support surface.

Do not use a wooden block or similar object as a support base for the jack, as this would prevent it from extending to its full support height and reduce its load-carrying capacity.

To avoid serious or fatal injury: never lie under the vehicle, and never start the engine while it is supported by the jack. ◀

What you will need

To avoid rattling noises later on, note the positions of the tools before removing them, then return them to their initial positions after completing work.



- 1 Chock*
- 2 Vehicle jack*
- 3 Lug wrench*

The tools are located in the hollow of the spare wheel.

Spare wheel*

1. Fold up the convertible top compartment floor, refer to Convertible: increasing luggage compartment capacity, page 35.
2. Pull back lock **1**, fold open tensioning lock **2** completely and loosen the belt **3**.

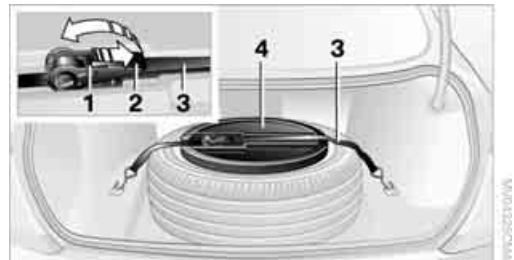

3. Remove the cover **4**.
4. Take the tool mounting out of the spare wheel.
5. Remove the spare wheel.

Preparing wheel change

1. Observe the safety precautions above.
2. Prevent the vehicle from rolling: Place the chock behind the front wheel on the other side of the vehicle, or on inclines, in front of this wheel. On steeply inclined roads, always secure the vehicle against rolling.
3. Loosen the lug bolts a half turn.

Jacking up vehicle



The jacking points for the car jack are located in the positions shown.

1. Position the vehicle jack at the jacking point closest to the wheel so that the entire surface of the jack base rests on the ground perpendicularly beneath the jacking point.

 The vehicle jack is designed for changing wheels only. Do not attempt to raise another vehicle model with it or to raise any load of any kind. To do so could cause accidents and personal injury. ◀

2. Guide the jack head into the rectangular recess of the jacking point when cranking up, refer to illustration detail.



3. Jack the vehicle up until the wheel you are changing is raised from the ground.

Mounting a wheel

1. Unscrew the lug bolts and remove the wheel.
2. Remove accumulations of mud or dirt from the mounting surfaces of the wheel and hub. Also clean the lug bolts.

3. Position the new wheel or spare wheel. Secure the wheel by screwing at least two lug bolts into opposite bolt holes. When you mount wheels other than Genuine BMW light-alloy wheels, different lug bolts may also be required.
4. Screw in the remaining lug bolts. Tighten all the bolts securely in a diagonal pattern.
5. Lower the vehicle and remove the jack from beneath the vehicle.

After mounting

1. Tighten the lug bolts in a diagonal pattern.

 To ensure safety, always have the lug bolts checked with a calibrated torque wrench as soon as possible to ensure that they are tightened to the specified torque. The tightening torque is 88.5 lb ft/120 Nm. ◀

2. Check and correct the tire inflation pressure at the earliest opportunity.

 Protect valve stems with valve stem seal caps against dirt and contamination. Dirt in valve stems is a frequent source of gradual air loss. ◀

3. Initialize the Flat Tire Monitor, refer to page 85, and the Sequential Manual Transmission, refer to After changing wheels/tires on page 201.
4. Replace the damaged tire as soon as possible and have the new wheel/tire balanced.

Stowing wheel and tools

 Convertible: A rear wheel can only be transported with the convertible top compartment floor folded up. ◀

1. Lay the wheel in the tool mounting.
2. Lay the cover on the mounting.
3. Coupe: center the wheel and cover relative to the lashing eyes 5. Convertible: slide the wheel as far as possible to the left and to the rear.

- Coupe: hook the belt into the lashing eyes **5** and lay it in the belt guide which runs in the center of the lid.

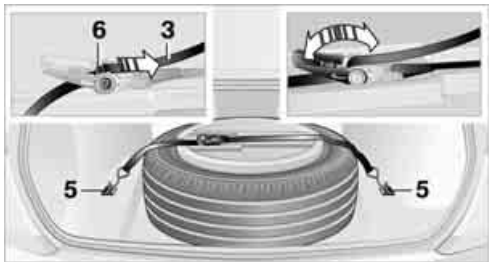

Convertible: hook the belt into the lashing eyes **5** and **7** and lay it in the belt guide of the lid which runs offset.



- Completely open the tensioning lock.
- Thread the belt **3** through the axis **6** of the tensioning lock without twisting it and tension it by hand.
- Tighten the belt firmly with the tensioning lock by opening and closing the lock several times.
- Fold the tensioning lock closed and stow the protruding belt end.

Driving with spare wheel

 With certain wheel-and-tire combinations the size of the spare wheel differs from that of the other wheels. The spare wheel is equivalent to them in all load and speed ranges. However, to restore the original state, the normal wheel should be remounted as soon as possible. ◀

Vehicle battery

Maintenance

The battery is 100% maintenance-free, i.e., the electrolyte will last for the life of the battery when the vehicle is operated in a temperate climate.

Your BMW center will be glad to advise in all matters concerning the battery.

Charging battery

Only charge the battery in the vehicle via the terminals in the engine compartment with the engine switched off. For the connections, refer to Jump starting on page [220](#).

Disposal



After replacement, have old batteries disposed of by your BMW center or deposit them at a recycling center. Maintain the battery in an upright position for transport and storage. Always secure the battery to prevent it from tipping over during transport. ◀

Power failure

Following a temporary interruption of the power supply, the operation of some equipment is limited and must be reinitialized. Individual settings are also lost and must be updated:

- ▷ Seat, mirror and steering wheel memory
The position must be stored again, refer to page [48](#).
- ▷ Time and Date
The values must be updated, refer to page [76](#).
- ▷ Radio
Stations must be stored again if necessary, refer to page [154](#).
- ▷ Navigation system
Wait until the system starts, refer to page [122](#).

Fuses

 Never attempt to repair a blown fuse, and do not replace a defective fuse with a substitute of another color or amperage rating, as this could lead to overloading of the wiring, ultimately resulting in a fire in the vehicle. ◀

Spare fuses and a pair of plastic tweezers are located in the compartment for the onboard tool kit, refer to page 209.

Information on fuse allocation is located below the bracket for the onboard tool kit, see below.

In glove compartment

1. Press the button on the back in the center of partition **1** and pull out the partition upward, arrow **2**.

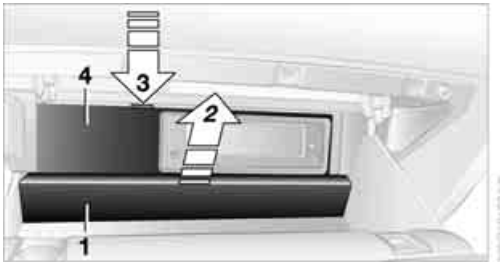

2. Press the coupling downward, arrow **3**, and fold the lid **4** forward.

In luggage compartment



Fold the cover under the floor mat upward and remove the bracket for the onboard tool kit. Information on fuse allocation **1** and additional fuses **2** are provided there.

Giving and receiving assistance

Emergency call

Conditions for an emergency call:

- ▶ Full preparation package mobile phone. With this equipment, an emergency call is still possible when no mobile phone is paired in the vehicle.
- ▶ BMW Assist is activated. Activating BMW Assist, refer to page 190.
- ▶ Radio readiness is activated.
- ▶ The BMW Assist system is logged on to a mobile phone network.
- ▶ The emergency call system is operable.

Once your service contract for BMW Assist expires, the BMW Assist system can be deactivated by a BMW center without you having to visit a workshop. Following deactivation of the BMW Assist system, no emergency calls can be made. The BMW Assist system can be reactivated after concluding a new agreement at a BMW center.

Initiating an emergency call

1. Briefly press protective cover to open. With some vehicle equipment packages or in the Convertible, the arrangement of the switches and indicator lamps may differ somewhat.



2. Press the button for at least 2 seconds. The LED in the button lights up. As soon as the voice connection to the BMW Assist Response Center has been established, the LED flashes.

When the emergency call is received at the BMW Assist Response Center, the BMW Assist Response Center contacts you and arranges for additional steps to help you.

If conditions allow, remain in the vehicle until the connection has been established. You will then be able to provide a detailed description of the situation.

If the current position of your vehicle can be determined, it will be transmitted to the BMW Assist Response Center.

If the LED is flashing but the BMW Assist Response Center cannot be heard over the hands-free system, it is possible that the hands-free system is malfunctioning. You may still be heard by the BMW Assist Response Center, however.

Under certain conditions, an emergency call is automatically initiated immediately after a severe accident. The automatic emergency call is not affected by the button being pressed.

 For technical reasons, the emergency call cannot be guaranteed under the most unfavorable conditions. ◀

 You can also use other services of BMW Assist with this button, refer to page 185. ◀

Warning triangle*



The warning triangle is located on the left-hand side in the luggage compartment.

First-aid kit*

The first-aid kit is located in the filler element of the rear seat backrest.

1. Press the button downward and pull the filler element forward.



2. Take out first-aid kit.



! To refit the filler element, insert the two bottom tabs into the strip and press the filler element back into place. Make sure that you do not damage the rear seat upholstery. ◀

Some of the articles contained in the first-aid kit have a limited service life. For this reason, check the expiration dates of each of the items regularly and replace any whose expiration dates have passed.

Roadside Assistance*

The Roadside Assistance of the BMW Group offers you assistance in the event of a breakdown around the clock, including on weekends and public holidays.

The phone numbers of the Roadside Assistance in your home country can be found in the BMW Contact directory.

With BMW Assist you can contact the Roadside Assistance of the BMW Group for assistance in the event of a breakdown directly via iDrive, refer to page 186.

Jump starting

When your battery is discharged, you can use two jumper cables to start your BMW with power from the battery in a second vehicle. You can also use the same method to help start another vehicle. Use only jumper cables with fully-insulated clamp handles.

! To avoid the risk of potentially fatal injury, always avoid all contact with electrical components while the engine is running. Carefully adhere to the following sequence, both to prevent damage to one or both vehicles, and to guard against possible personal injuries. ◀

Preparing

1. Check whether the battery of the other vehicle has a voltage of 12 Volts and approximately the same capacitance in Ah. This information can be found on the battery.
2. Switch off the engine of the vehicle providing assistance.
3. Switch off any electrical systems and components in both vehicles.

! There must not be any contact between the bodies of the two vehicles; otherwise, there is a danger of short circuiting. ◀

Connecting jumper cables

! To avoid personal injury from sparks, follow this sequence when connecting jumper cables. ◀

In your BMW M6, the so-called jump-starting terminal for jump starting in the engine compartment serves as a positive terminal for the battery, also refer to engine compartment overview on page 203. The cover cap is marked with a +.

1. Fold open the cover of the BMW jump-starting terminal. To do so, pull the tab.



2. Attach one end of the jumper cable plus/+ to the positive terminal of the battery or a jump-starting terminal of the vehicle providing assistance.
3. Attach the second end of the cable to the positive terminal of the battery or to a jump-starting terminal of the vehicle to be started.
4. Attach one end of the jumper cable minus/- to the negative terminal of the battery or to an engine or body ground of the vehicle providing assistance.
Your BMW M6 has a special nut as body ground or negative terminal.



5. Attach the second end of the cable to the negative terminal of the battery or to the engine or body ground of the vehicle to be started.

Starting engine

1. Start the engine on the assisting vehicle and allow it to run at idle for several minutes at slightly increased speed.
2. Start the engine on the other vehicle in the usual way.
If the first starting attempt is not successful,

wait a few minutes before another attempt in order to allow the discharged battery to recharge.

3. Let the engines run for a few minutes.
4. Disconnect the jumper cables by reversing the connection sequence.

Check the battery and recharge if necessary.

- ⚠ Never use spray fluids to start the engine. ◀

Tow-starting and towing

- ⚠ Observe applicable laws and regulations for tow-starting and towing. ◀

- ⚠ Do not transport any passengers other than the driver in a vehicle that is being towed. ◀

Using tow fitting

The threaded tow fitting is stored in the tool kit mounted on the inside of the luggage compartment under the floor mat, refer to page 209, and should always remain in the vehicle. It can be screwed in at the front or rear of the BMW M6.

- ⚠ Only use the tow fitting that comes with the vehicle and screw it in as far as possible. Use the tow fitting for towing only on roads. Avoid lateral loading of the tow fitting, e.g. do not lift the vehicle by the tow fitting. Otherwise, the tow fitting and vehicle can be damaged. ◀

Access to screw thread

Front: press the arrow symbol on the cover in the bumper.

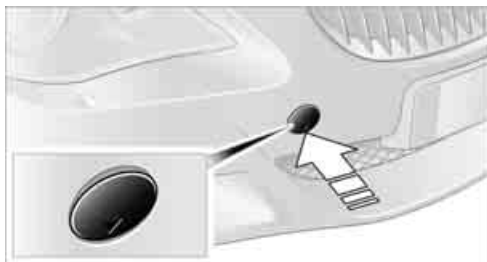

Rear: press the arrow symbol on the cover while prying out the cover upward by hand.



Being towed

⚠ Make sure that the ignition is switched on, refer to page 58; otherwise, the low-beam headlamps, tail lights, turn signals and wind-shield wipers would not be available. Do not tow the vehicle with the rear axle raised, as otherwise the steering can turn to the left or right. When the engine is stopped, there is no power assist. This then requires increased effort for braking and steering. ◀

Switch on the hazard warning flashers depending on the local regulations. If the electrical system fails, mark the vehicle to be towed, e.g. with a sign or warning triangle in the rear window.

Manual transmission

Gearshift lever in neutral position.

Sequential Manual Transmission with Drivelogic

⚠ Make sure that selector lever position N is engaged with the ignition switched on, as otherwise the engine can be damaged during towing. ◀

Towing methods

⚠ Do not lift vehicle by tow fitting or body and chassis parts; otherwise, damage may result. ◀

In some countries, towing with tow bars or ropes in public traffic is not permitted. Familiarize yourself with the regulations on towing in the respective country.

With tow bar

⚠ The towing vehicle may not be lighter than the vehicle to be towed; otherwise, it will not be possible to reliably control vehicle response. ◀

The tow fittings used should be on the same side on both vehicles. Should it prove impossible to avoid mounting the tow bar at an offset angle, please note the following:

- ▷ Clearance and maneuvering capability will be strictly limited during cornering.
- ▷ When mounted at an angle, the tow bar will exert lateral forces, tending to push the vehicle sideways.

⚠ Attach the tow bar to the tow fittings only, as attachment to other vehicle parts can lead to damage. ◀

With tow rope

When starting off in the towing vehicle, make sure that the tow rope is taut.

⚠ To avoid jerking and the associated stresses on vehicle components when towing, always use nylon ropes or nylon straps. Attach tow ropes to the tow fittings only, as attachment to other vehicle parts can lead to damage. ◀

With tow truck

⚠ Do not tow the vehicle with only the front or rear axle raised, as otherwise the engine may be damaged or the steering can turn to the left or right. ◀

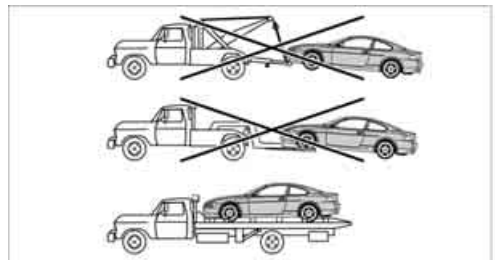

Have the vehicle transported on a flatbed surface only.

Tow-starting

Do not tow-start the vehicle if possible, but instead start the engine by means of jump starting, refer to page 220. With a catalytic converter, the vehicle should only be tow-started with the engine cold.

Manual transmission

1. Switch on the hazard warning flashers, comply with country-specific regulations.
2. Switch on the ignition, refer to page 58.
3. Shift into 3rd gear.
4. Tow-start with the clutch completely depressed and slowly release the clutch. After the engine starts, immediately depress the clutch again completely.
5. Stop at a suitable location, remove the tow bar or rope and switch off the hazard warning flashers.
6. Have the vehicle checked.

Sequential Manual Transmission with Drivelogic

1. Switch on the hazard warning flashers, comply with country-specific regulations.
2. Switch on the ignition, refer to page 58.
3. Tow-start in selector lever position N.
4. Move the selector lever into the drive position and pull toward + within 2 seconds. The correct gear will be selected and engaged automatically.
5. Stop at a suitable location, remove the tow bar or rope and switch off the hazard warning flashers.
6. Have the vehicle checked.



Reference

This chapter contains the technical data, the short commands of the voice command system, and the index that will direct you as quickly as possible to the information you are looking for.

Technical data

Dimensions

Coupe

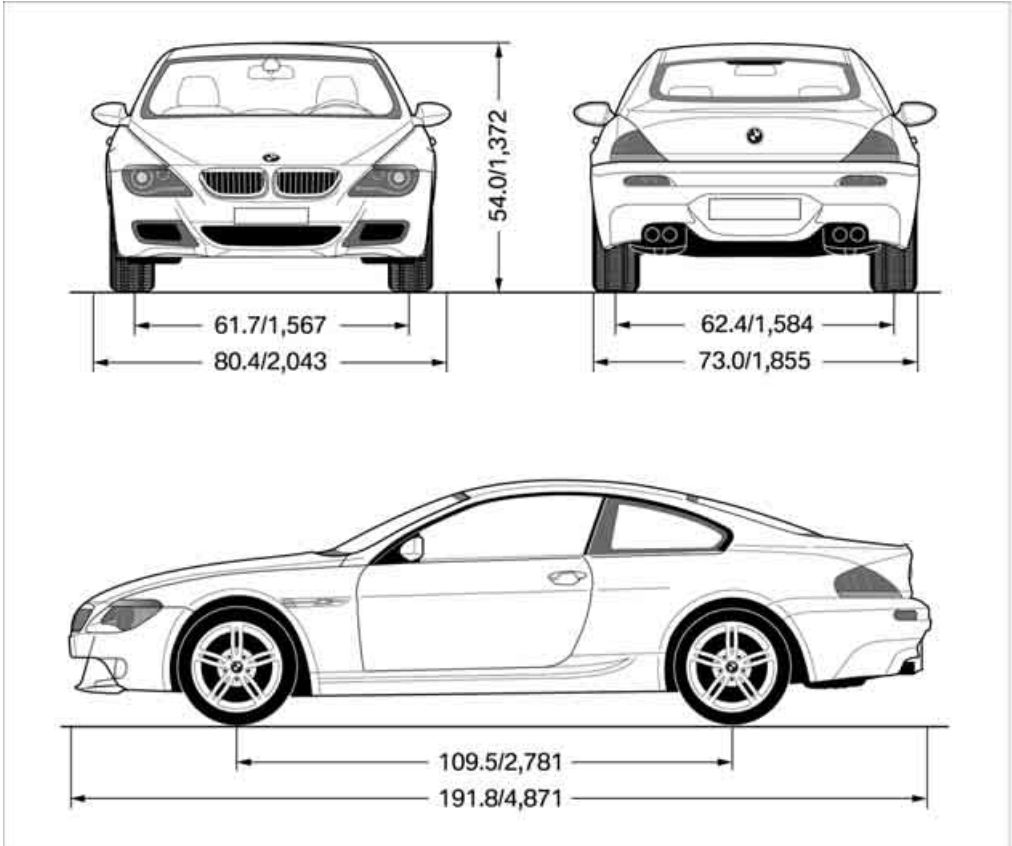

All dimensions given in inches/mm. Smallest turning circle diam.: 41.0 ft/12.5 m

Convertible

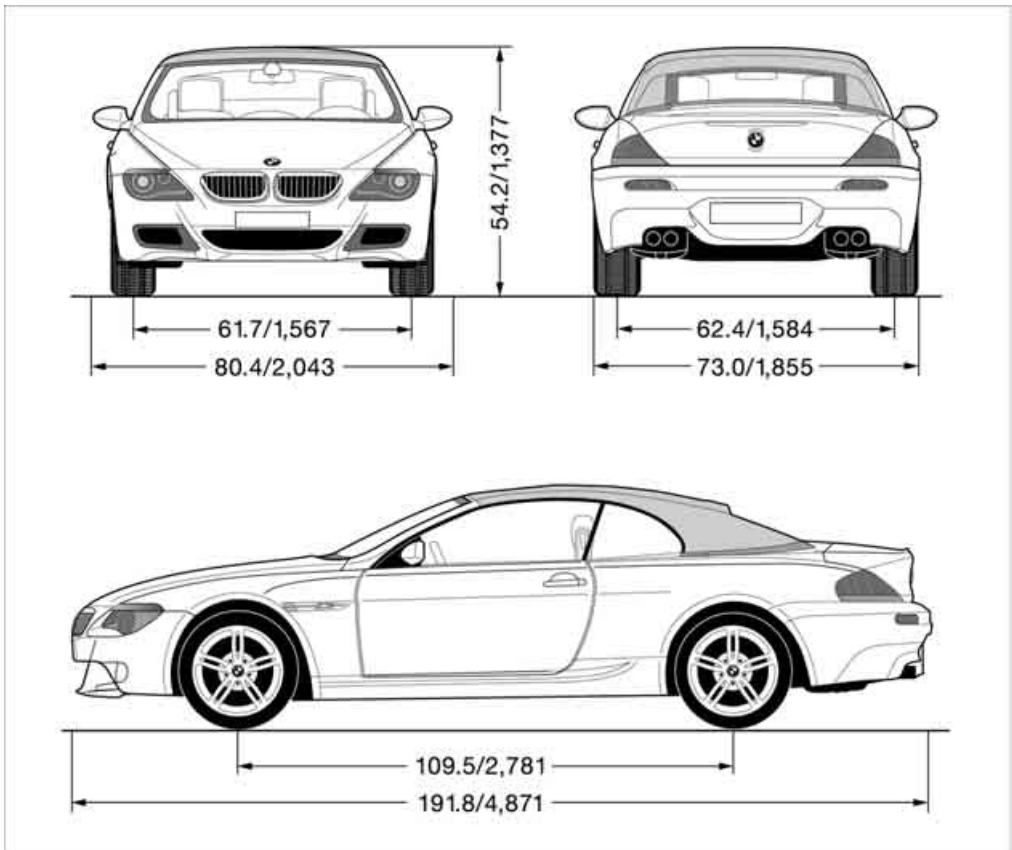

All dimensions given in inches/mm. Smallest turning circle diam.: 41 ft/12.5 m

Weights

		M6 Coupe	M6 Convertible
Curb weight	lbs./kg	3,909/1,773	4,398/1,995
Approved gross vehicle weight	lbs./kg	4,850/2,200	5,247/2,380
Load	lbs./kg	941/427	849/385
Approved front axle load	lbs./kg	2,403/1,090	2,469/1,120
Approved rear axle load	lbs./kg	2,646/1,200	2,844/1,290
Luggage compartment capacity	cu ft/l	15.9/450	10.6/300
▶ with raised convertible top compartment floor, refer to page 35	cu ft/l	–	12.4/350

Never exceed either the approved axle loads or the gross vehicle weight.

Capacities

			Notes
Fuel tank	US gal/liters	approx. 18.5/70	Fuel specification: page 195
including reserve of:	US gal/liters	approx. 4/15	
Window and headlamp wiper system	US quarts/liters	approx. 5.3/5	For details: page 66

Short commands of voice command system*

With short commands you can run certain functions directly, regardless of which menu item is

selected. Here are the important short commands for the voice command system.

Assistance window

Function	Command
To open the assistance window 20	›Assistance window‹
To select the display in the assistance window 20	›Assistance window map facing north‹, ›Assistance window map direction of travel‹, ›Assistance window arrow display‹, ›Assistance window perspective‹, ›Assistance window current position‹, ›Assistance window trip computer‹ or ›Assistance window onboard info‹
To change scale in assistance window 122	›Assistance window scale ... feet‹ or ›Assistance window scale ... miles‹

Communication

Function	Command
To activate telephone 177	›Phone‹
To dial phone number 177	›Dial number‹
To display the phone book 178	›A to Z‹
To dial from phone book 178	›Call ...‹ or ›Dial name‹
To display "Top 8" 179	›Top 8‹
To redial 179	›Redial‹
To display "Received calls" 179	›Received calls‹
To display "Missed calls" 179	›Missed calls‹
To display "Bluetooth" 171	›Bluetooth‹
To open BMW Assist 185	›BMW Assist‹
To open BMW Service, Services 185	›BMW Service‹
To open "BMW Contact" 179	›BMW Contact‹
To open "BMW Contact Numbers" 187	›BMW Contact numbers‹
To open "Roadside Assistance" 186	›Roadside Assistance‹

Navigation

Function	Command
To open navigation 122	›Navigation‹
To open "Enter address"	›Enter address‹
To open "New destination"	›New destination‹
To display "Input map"	›Input map‹
To display destination list	›Destination list‹
To display the address book	›Address book‹
To display the route criteria	›Route preference‹
To start destination guidance	›Start guidance‹
To end destination guidance	›Stop guidance‹
To display arrow display	›Arrow display‹
To display map view	›Map‹, ›Map facing north‹, ›Map direction of travel‹ or ›Perspective‹
To change scale	›Scale ... miles‹ or ›Scale ... feet‹
To display streets and towns/cities of the route	›Route list‹
To switch on voice instructions	›Navigation info on‹
To switch off voice instructions	›Navigation info off‹
To repeat voice instructions	›Repeat navigation info‹
To open route	›Route menu‹
To display current position	›Current position‹

Onboard info

Function	Command
To open "Car Data" 70	›Car data‹
To display the computer 70	›Onboard info‹
To display the trip computer 71	›Trip computer‹
To start the stopwatch 76	›Stopwatch‹
To set the speed limit 75	›Limit‹
To activate speed limit 76	›Limit on‹
To deactivate speed limit 76	›Limit off‹

Entertainment

Function	Command
Tone control 149	›Audio‹
To switch on radio 152	›Radio on‹, ›FM‹ or ›AM‹
To open "FM" 152	›FM menu‹
To open "AM" 152	›AM menu‹
To open "All stations" 152	›FM All stations‹
To select the radio station 152	›Station ...‹, e.g. ›Station WNYC‹, or ›Choose station‹
To open "Presets" 152	›FM presets‹ or ›AM presets‹
To select preset radio station 152	›Preset ...‹, e.g. ›Preset 1‹
To open "Manual" 153	›FM manual‹, ›AM manual‹ or ›Choose frequency‹, ›Frequency ... Megahertz‹
To open the radio station with the best reception 153	›AM Autostore‹
To open "WB" 156	›Weatherband menu‹
To switch on weatherband 156	›Weatherband on‹
To select a weatherband station 156	›Choose weatherband station‹
To open "SAT" 158	›SAT radio menu‹
To switch on satellite radio 158	›SAT radio‹
To open "Presets" of satellite radio 159	›SAT radio presets‹
To open "All channels" of satellite radio 158	›SAT radio all channels‹
To open "Categories" of satellite radio 158	›SAT radio categories‹
To select CD player 161	›CD menu‹
To switch on CD player 161	›CD‹
To select CD changer 161	›CD changer menu‹
To switch on CD changer 161	›CD changer‹
To select a CD in the CD changer 161	›CD 1...6‹
To select music track 162	›CD track ...‹
To select a CD and music track in the CD changer 162	›CD 1...6 track ...‹
To switch on audio playback with external audio device 167	›Audio Aux‹

Climate

Function	Command
To open "Vent settings" 101	›Vent settings‹
To open "Automatic programs" 100	›Automatic programs‹
To open "Parked car ventilation" 103	›Parked car operation‹
To open "Automatic ventilation" 103	›Automatic ventilation‹
To display the activation times 103	›Activation time‹

i menu

Function	Command
To open the i menu	›Settings menu‹
"Display off" 21	›Display off‹
To open "Info sources"	›Info sources‹
To open "Settings"	›Settings‹
To open "Door locks" 30, 32	›Door locks‹
To open "Steering wheel buttons" 53	›Steering wheel buttons‹
To open MDrive 54	›MDrive‹
To open "Lighting" 64, 95	›Lighting‹
To open "Service requirements" 72, 187	›Service requirements‹
To open "Service" 72, 187	›Service‹
To open "BMW Service settings" settings 189	›BMW service settings‹
To display "Check Control messages" 73	›Check Control messages‹
To open "Head-Up Display" 92	›Head-up display‹
To adjust the brightness of the Control Display 78	›Brightness‹
To open "Units" 78	›Units‹
To open "Languages" 79, 122	›Language‹
To open "Time" 77	›Time‹
To open "Date" 78	›Date‹
To open "PDC" 81	›PDC‹
To open "FTM" 85	›FTM‹
To open "TPM" 87	›TPM‹
To display "Bluetooth" 171	›Bluetooth‹

Everything from A to Z

Index

"..." Identifies Control Display texts used to select individual functions, and indicates where to find them in the text.

A

- ABS Antilock Brake System [81](#)
 - indicator/warning lamp [83](#)
- Accepted calls [178](#)
- Accessories [6](#)
- Accident, refer to Emergency call [219](#)
- Activated-charcoal filter for automatic climate control [103](#)
- Activating hour signal [77](#)
- "Activation time" for parked-car ventilation [103](#)
- Adapter for spare key [28](#)
- Adaptive brake lamps, refer to Brake force display [88](#)
- Adaptive Head Light [96](#)
- "Add digits" for mobile phone [178](#)
- Additives
 - coolant [205](#)
 - engine oil, refer to Approved engine oils [205](#)
- "Address book" for navigation system [132](#)
- Address for navigation
 - deleting [133](#)
 - entering [124](#), [127](#)
 - selecting [132](#)
 - storing [132](#)
 - storing current position [132](#)
- "Add to address book" [131](#)
- "Add to destination list" [127](#), [129](#)
- Adjusting interior temperature [100](#)
- Adjusting thigh support [47](#)
- Adjusting tone in audio mode, refer to Tone control [149](#)
- "After door opened" [49](#)
- "After unlocking" [49](#)
- Airbags [89](#)
 - deactivating, refer to Exception for front passenger seat [56](#)
 - indicator/warning lamp [90](#)
 - indicator lamp for front passenger airbags [90](#)
 - sitting safely [46](#)
- Air distribution
 - automatic [100](#)
 - manual [101](#)
- Airing, refer to Ventilation [102](#)
- Air outlets, refer to Ventilation [102](#)
- Air recirculation, refer to AUC Automatic recirculated-air control [102](#)
- "Air recirculation on / off" [53](#)
- Air supply, automatic climate control [99](#)
- Air volume [101](#)
- AKI, refer to Fuel specifications [195](#)
- Alarm system [35](#)
 - avoiding unintentional alarms [36](#)
 - interior motion sensor [36](#)
 - switching off alarm [36](#)
 - switching off tilt alarm sensor and interior motion sensor [36](#)
 - tilt alarm sensor [36](#)
- "All channels" [158](#)
- "All doors" [30](#)
- All-season tires, refer to Winter tires [200](#)
- "All stations", calling up with radio [152](#), [155](#)
- Alterations, technical, refer to For your own safety [6](#)
- "AM", reception range [148](#), [152](#)
- Antenna, refer to Caring for your vehicle brochure
- Antenna for mobile phone [170](#)
- Antifreeze
 - coolant [205](#)
 - washer fluid [66](#)
- Antilock Brake System ABS [81](#)
 - indicator/warning lamp [83](#)
- Anti-theft alarm system, refer to Alarm system [35](#)
- Anti-theft system, refer to Central locking system [30](#)
- Approved axle loads, refer to Weights [228](#)
- Approved engine oils [205](#)
- Approved gross vehicle weight, refer to Weights [228](#)
- Armrest, refer to Center armrest [107](#)
- Around the center console [14](#)
- Around the steering wheel [10](#)
- Arrival time
 - refer to Computer [70](#)
 - refer to Starting destination guidance [136](#)
- "Arrow display" for navigation system [137](#)
- Artificial leather, refer to Caring for your vehicle brochure
- Ashtray [108](#)
- Assist, refer to BMW Assist [185](#)
- Assistance systems, refer to Driving stability control systems [81](#)

Assistance window [20](#)
"Assist. window off" [21](#)
AUC Automatic recirculated-air control [102](#)
"Audio" [149](#), [151](#), [156](#)
Audio [148](#)
– controls [148](#)
– switching on/off [148](#)
– tone control [149](#)
– volume [149](#)
Audio device, external [107](#)
Automatic
– air distribution [100](#)
– air volume [100](#)
– cruise control [66](#)
– headlamp control [95](#)
– recirculated-air control AUC [102](#)
– service notification [187](#)
– steering wheel adjustment [48](#)
– storing stations [153](#)
Automatic car washes [116](#)
– also refer to Caring for your vehicle brochure
Automatic climate control [99](#)
– automatic air distribution [100](#)
– convertible program [100](#)
– switching on and off [102](#)
– ventilation with vehicle parked [103](#)
Automatic closing of doors, refer to Automatic soft closing [34](#)
Automatic curb monitor [52](#)
Automatic lighting
– refer to Automatic headlamp control [95](#)
– refer to Daytime running lamps [96](#)
– refer to Interior lamps [97](#)
– refer to Pathway lighting [95](#)
"Automatic programs" [100](#)
Automatic soft closing [34](#)
Automatic station search [153](#)
"Automatic ventilation" [103](#)

AUTO program with automatic climate control [100](#)
"Autostore" on the radio [152](#), [154](#)
"AUX" [148](#), [167](#)
AUX-In connection [107](#), [167](#)
Average fuel consumption [70](#)
– setting units [78](#)
"Avoid ferries" for navigation system [135](#)
"Avoid highways" for navigation system [134](#)
Avoiding freeways for navigation [134](#)
Avoiding unintentional alarms [36](#)
"Avoid tollroads" for navigation system [135](#)
Axle loads, refer to Weights [228](#)
"A - Z" [178](#)

B

Backrest contour, refer to Lumbar support [47](#)
Backrests, refer to Seats [47](#)
Backrest width adjustment [47](#)
Backup lamps, replacing bulbs, refer to Tail lamps [211](#)
"Balance", refer to Tone control [150](#)
Band-aids, refer to First-aid kit [220](#)
Bass, refer to Tone control [149](#)
"Bass", tone control [149](#)
Battery
– jump starting [220](#)
– refer to Vehicle battery [217](#)
Battery replacement, remote control for comfort access [38](#)
BC button, refer to Computer [69](#)
Being towed [222](#)
Belts, refer to Safety belts [51](#)
Beverage holder, refer to Cup holders [108](#)
Blower, refer to Air volume [101](#)
"Bluetooth" [172](#)
"BMW Assist" [186](#)
BMW Assist [185](#)
– activating [190](#)
– breakdown assistance [186](#)
– contacting BMW Customer Relations [188](#)
– displaying vehicle data [191](#)
– information service [188](#)
– services offered [185](#)
– TeleService [187](#)
– updating [189](#)
"BMW Contact" [180](#)
"BMW Contact Numbers" [180](#)
BMW homepage [4](#)
BMW Maintenance System [207](#)
"BMW Service settings" [189](#)
BMW website [4](#)
Bottle holder, refer to Cup holders [108](#)
Bracket for telephone or mobile phone, refer to Snap-in adapter [183](#)
Brake assistant [82](#)
Brake force display [88](#)
Brake lamps
– replacing bulbs, refer to Tail lamps [211](#)
– two-stage [88](#)
Brake rotors
– breaking-in [114](#)
– refer to Braking safely [116](#)
Brakes
– ABS Antilock Brake System [81](#)
– brake force display [88](#)
– breaking-in [114](#)
– CBC Cornering Brake Control [81](#)
– electronic brake-force distribution [81](#)
– handbrake [60](#)
– refer to Braking safely [116](#)

Brake system [114](#)
 – brake pads [114](#)
 – brake rotors [116](#)
 – breaking-in [114](#)
 – warning lamp [13, 83](#)
 Braking safely [116](#)
 Breakdown, M Mobility System [212](#)
 Breakdown assistance [186](#)
 Breakdown services, refer to Roadside Assistance [220](#)
 Breaking-in [114](#)
 Breaking-in brake pads [114](#)
 Breaking-in the clutch [114](#)
 Breaking-in the differential, refer to Engine and differential [114](#)
 "Brightness" [78, 93](#)
 Brightness of Control Display [78](#)
 Button for starting engine, refer to Start/Stop button [58](#)
 Buttons on steering wheel [11](#)
 Bypassing route sections [140](#)

C

California Proposition 65 Warning [6](#)
 "Call" [178, 189](#)
 Call
 – accepting [176](#)
 – displaying accepted [179](#)
 – ending [177](#)
 – in absence [179](#)
 – rejecting [177](#)
 – starting [177](#)
 Calling
 – by entering phone number [177](#)
 – from phone book [178](#)
 – from Top 8 list [179](#)
 – redialing [179](#)
 Can holder, refer to Cup holders [108](#)
 Capacities [228](#)
 Car battery, refer to Vehicle battery [217](#)
 Car care, refer to Caring for your vehicle brochure
 Car-care products, refer to Caring for your vehicle brochure
 "Car Data" [70](#)
 Care [208](#)
 – refer to Caring for your vehicle brochure
 Cargo loading
 – securing cargo [118](#)
 – stowing cargo [117](#)
 – vehicle [117](#)
 Caring for artificial leather, refer to Caring for your vehicle brochure
 Caring for leather, refer to Caring for your vehicle brochure
 Caring for light-alloy wheels, refer to Caring for your vehicle brochure
 Caring for plastic, refer to Caring for your vehicle brochure
 Caring for the carpet, refer to Caring for your vehicle brochure
 Caring for the vehicle finish, refer to Caring for your vehicle brochure
 Car key, refer to Keys/remote control [28](#)
 Car phone [171](#)
 – installation location, refer to Center armrest [107](#)
 – refer to Mobile phone [170](#)
 – refer to separate operating instructions
 Car radio, refer to Radio [152](#)
 Car wash [116](#)
 – refer to Before driving into a car wash [116](#)
 – refer to Caring for your vehicle brochure
 Catalytic converter, refer to Hot exhaust system [115](#)
 "Categories" [158](#)
 CBC Cornering Brake Control [81](#)
 CBS Condition Based Service [207](#)
 "CD" [148, 161](#)
 CD changer [161](#)
 – controls [148](#)
 – fast forward/reverse [164](#)
 – installation location [164](#)
 – random sequence [164](#)
 – repeating a track [163](#)
 – sampling a track [163](#)
 – selecting a CD [161](#)
 – selecting a track [162](#)
 – switching on/off [148](#)
 – tone control [149](#)
 – volume [149](#)
 CD player [161](#)
 – controls [148](#)
 – fast forward/reverse [164](#)
 – random sequence [164](#)
 – repeating a track [163](#)
 – sampling a track [163](#)
 – selecting a track [162](#)
 – switching on/off [148](#)
 – tone control [149](#)
 – volume [149](#)
 Center armrest, adjusting height [107](#)
 Center console [14](#)
 "Central locking" [30](#)
 Central locking
 – from inside [32](#)
 – from outside [30](#)
 Central locking system [30](#)
 – comfort access [37](#)
 – hotel function [33](#)
 Changes, technical, refer to For your own safety [6](#)
 Changing a wheel [215](#)
 Changing language on Control Display [79](#)
 Changing scale for navigation system display [138](#)
 Changing units of measure on Control Display [78](#)

- Changing wheels [200](#)
- CHECK button [74](#)
- Check Control [73](#)
- "Check Control messages" [74](#)
- Check Gas Cap [194](#)
- Checking air pressure, refer to
 - Tire inflation pressure [196](#)
- Child-restraint fixing system LATCH [57](#)
- Child restraint systems [56](#)
- Child seats, refer to
 - Transporting children safely [56](#)
- Chock [215](#)
- Chrome parts, refer to Caring for your vehicle brochure
- Cigarette lighter [108](#)
- Cigarette lighter socket, refer to Connecting electrical devices [109](#)
- Cleaning, refer to Caring for your vehicle brochure
- "Climate" [100](#)
- Clock [69](#)
 - 12h/24h mode [77](#)
 - hour signal [77](#)
 - setting time and date [77](#)
- Closing
 - from inside [32](#)
 - from outside [30](#)
- Closing fuel filler cap [194](#)
- Clothes hooks, Coupe [108](#)
- Cockpit [10](#)
- Cold start, refer to Starting engine [59](#)
- Comfort access [37](#)
 - replacing battery, remote control [38](#)
- Comfort closing
 - windows, with comfort access with Coupe [37](#)
 - with comfort access [37](#)
- Comfort operation
 - convertible top [31](#), [32](#)
 - windows [31](#), [32](#)
- "Comfort" with EDC [84](#)
- "Communication" [176](#), [186](#)
- Compact disc
 - refer to CD changer [161](#)
 - refer to CD player [161](#)
- Compartment for remote control, refer to Ignition lock [58](#)
- Compartments, refer to
 - Storage compartments [107](#)
- Compressed audio files [161](#)
- Computer [69](#)
 - clock [69](#)
 - displays on Control Display [70](#)
 - hour signal [77](#)
- "Concert hall", refer to Tone control [151](#)
- "Concierge" [188](#)
- Condensation, refer to When vehicle is parked [116](#)
- Condition Based Service CBS [207](#)
- "Confirmation" [31](#)
- Confirmation signals for locking and unlocking [31](#)
- Connecting car vacuum cleaner, refer to Connecting electrical devices [109](#)
- Consumption display, refer to
 - Average fuel consumption [70](#)
- Consumption statistics, refer to
 - Average fuel consumption [70](#)
- "Continue guidance to destination?" [137](#)
- Control Center, refer to iDrive [16](#)
- Control Display, refer to iDrive [16](#)
 - setting brightness [78](#)
 - switching off/on [21](#)
- Controller, refer to iDrive [16](#)
- Controls, refer to Cockpit [10](#)
- Convertible
 - convertible program for automatic climate control [100](#)
 - opening and closing windows [39](#)
 - rollover protection system [91](#)
 - top [40](#)
 - wind deflector [44](#)
 - window and convertible top operation with comfort access [37](#)
- Convertible top
 - care, refer to Caring for your vehicle brochure
 - closing manually [42](#)
 - comfort operation [32](#)
 - emergency closing [42](#)
 - opening and closing [41](#)
- Coolant [205](#)
 - checking level [205](#)
 - temperature [68](#)
- Cooling, maximum [102](#)
- Cooling function, automatic climate control [101](#)
- Cooling system, refer to
 - Coolant [205](#)
- Copyright [2](#)
- Cornering Brake Control CBC [81](#)
- Country of destination for navigation [125](#)
- Courtesy lamps, refer to
 - Interior lamps [97](#)
- Cradle for telephone or mobile phone [107](#)
- Cruise control [66](#)
- Cruising range [70](#)
- Cup holders [108](#)
- Curb weight, refer to
 - Weights [228](#)
- "Current position" [144](#)
- Current position
 - displaying [144](#)
 - entering [132](#)
 - storing [132](#)
- "Customer Relations" [180](#), [188](#)

D

- Dashboard, refer to Cockpit [10](#)
- Data, technical [226](#)
 - capacities [228](#)
 - dimensions [226](#)
 - measurements [226](#)
 - weights [228](#)
- "Date" [78](#)
- Date
 - display format [78](#)
 - setting [78](#)
- "Date format" [78](#)
- "Daytime running lamps" [96](#)
- Daytime running lamps [96](#)
- DBC Dynamic Brake Control, warning lamp [84](#)
- "Deactivated" [49](#)
- Decommissioning the vehicle, refer to Caring for your vehicle brochure
- Defect
 - tires, refer to Flat Tire Monitor [84](#)
 - tires, refer to Tire Pressure Monitor [86](#)
- Defrosting windows [101](#)
- Defrosting windows and removing condensation [101](#)
- Defrosting windshield, refer to Defrosting windows [101](#)
- Defrost position, refer to Defrosting windows [101](#)
- "Delete address book" for navigation system [133](#)
- "Delete all numbers" for mobile phone [179](#)
- "Delete data" for navigation system [133](#)
- "Delete" for mobile phone [179](#)
- Destination address
 - deleting [133](#)
 - entering [124](#), [127](#)
- Destination for navigation
 - destination list [131](#)
 - entering via voice [127](#)
 - entry [124](#)
 - home address [134](#)
 - selecting from address book [132](#)
 - selecting using information [130](#)
 - storing [132](#)
- Destination guidance [136](#)
 - bypassing route sections [140](#)
 - canceling voice instructions [54](#)
 - changing specified route [134](#)
 - displaying route [137](#)
 - distance and arrival [136](#)
 - interrupting [136](#)
 - starting [136](#)
 - terminating/continuing [136](#)
 - voice instructions [139](#)
 - volume of voice instructions [140](#)
- Destination list for navigation [131](#)
- Destinations recently driven to [131](#)
- "Details" in audio mode [163](#)
- "Detour" for navigation system [143](#)
- "Dial" for mobile phone [177](#)
- "Dial number" [177](#)
- Digital clock [69](#)
- Digital radio, refer to High Definition Radio [156](#)
- Dimensions
 - Convertible [227](#)
 - Coupe [226](#)
- Directional indicators, refer to Turn signals [64](#)
- Direction announcements, refer to Voice instructions [139](#)
- Direction instructions, refer to Voice instructions [139](#)
- Directory, refer to Phone book [178](#)
- Directory for navigation, refer to Address book [132](#)
- "Display" [78](#)
- Display, refer to iDrive controls [16](#)
- Display elements, refer to Instrument cluster [12](#)
- Displaying vehicle data [191](#)
- Display lighting, refer to Instrument lighting [97](#)
- "Display off" [21](#)
- Displays
 - on Control Display, refer to iDrive [16](#)
 - refer to Instrument cluster [12](#)
- "Display settings" [78](#), [92](#)
- Displays on the windshield, refer to Head-Up Display [91](#)
- Disposal
 - battery of remote control with comfort access [38](#)
 - coolant [205](#)
 - vehicle battery [217](#)
- Distance, refer to Computer [70](#)
- "Distance to dest." [70](#)
- Distance to destination, refer to Computer [70](#)
- Distance warning, refer to PDC Park Distance Control [80](#)
- Door entry lighting, refer to Interior lamps [97](#)
- Door key, refer to Keys/remote control [28](#)
- Door lock [32](#)
- "Door locks" [30](#), [72](#)
- Doors
 - manual operation [32](#)
 - remote control [31](#)
- DOT Quality Grades [198](#)
- Draft-free ventilation [103](#)
- Drivelogic [62](#)
- "Driver's door only" [31](#)

Driving lamps, refer to Parking lamps/low beams [95](#)
 Driving programs, refer to Drivelogic [62](#)
 Driving route, refer to Displaying route [137](#)
 Driving stability control systems [81](#)
 Driving through water [115](#)
 Driving tips, refer to General driving notes [114](#)
 Drying the air, refer to Cooling function [101](#)
 "DSC" [54](#), [82](#)
 DSC Dynamic Stability Control [82](#)
 – indicator lamp [13](#), [82](#)
 – malfunction [83](#)
 DVD for navigation [122](#)
 "Dynamic route" for navigation [135](#)
 Dynamic Stability Control DSC [82](#)
 – M Dynamic Mode MDM [82](#)

E

Easy entry, refer to Entering rear [50](#)
 Easy entry/exit [53](#)
 "EDC" [54](#)
 EDC Electronic Damping Control [84](#)
 – "Comfort" [84](#)
 – "Normal" [84](#)
 – "Sport" [84](#)
 Eject button, refer to Buttons on CD player [148](#)
 Electrical malfunction
 – convertible top [42](#)
 – door lock [32](#)
 – driver's door [32](#)
 – fuel filler door [194](#)
 – luggage compartment lid [34](#)
 – storage compartment, hotel function [34](#)

Electric convertible top [40](#)
 Electric steering wheel adjustment [53](#)
 Electronic brake-force distribution [81](#)
 Electronic Damping Control EDC [84](#)
 Emergency assistance, refer to Roadside Assistance [220](#)
 Emergency call [219](#)
 Emergency operation, refer to Manual operation
 – convertible top [42](#)
 – door lock [32](#)
 – driver's door [32](#)
 – fuel filler door [194](#)
 – hotel function [34](#)
 – luggage compartment lid [34](#)
 Emergency release for luggage compartment lid in luggage compartment [35](#)
 Emergency services, refer to Roadside Assistance [220](#)
 "Enable services" [191](#)
 "End call" [178](#)
 Engaging forward position, refer to Selector lever positions [61](#)
 Engine
 – breaking-in [114](#)
 – M Engine Dynamic Control [64](#)
 – overheated, refer to Coolant temperature [68](#)
 – starting [59](#)
 – starting, comfort access [37](#)
 – switching off [59](#)
 Engine compartment [203](#)
 Engine coolant [205](#)

Engine oil
 – adding [204](#)
 – additives, refer to Approved engine oils [205](#)
 – approved oils [205](#)
 – checking oil level [203](#)
 – exact measurement [204](#)
 – fast measurement [204](#)
 – interval between changes, refer to Service requirements [71](#)
 – oil change [205](#)
 – oil grades, refer to Approved engine oils [205](#)
 – possible displays [204](#)
 – recommended oils [205](#)
 – temperature [69](#)
 – temperature gauge [69](#)
 Engine overheating, refer to Coolant temperature [68](#)
 Engine starting, refer to Starting engine [59](#)
 "Enter address" [124](#), [132](#)
 Entering address [124](#), [127](#)
 Entering intersection, navigation [126](#)
 Entering rear [50](#)
 Entering town/city for navigation [125](#)
 Entering town/city of destination name [125](#)
 Entering zip code for navigation [125](#)
 "Entertainment" [148](#)
 Entertainment sound output on/off [149](#)
 Entry map for destination [129](#)
 Equalizer, refer to Tone control [151](#)
 "Equalizer", tone control [151](#)
 "ESN" [158](#)
 ESP Electronic Stability Program, refer to DSC Dynamic Stability Control [82](#)
 Event data recorders [208](#)

Exhaust system, refer to Hot exhaust system [115](#)
 Exterior mirrors [52](#)
 – adjusting [52](#)
 – automatic dimming feature [52](#)
 – automatic heating [52](#)
 – folding in and out [52](#)
 – tilting down passenger-side mirror [52](#)
 External audio device [107](#)
 Eye for tow-starting and towing, refer to Tow fitting [221](#)
 Eyes for lashing, refer to Securing cargo [118](#)

F

"Fader", refer to Tone control [150](#)
 Fader, refer to Tone control [150](#)
 Failure messages, refer to Check Control [73](#)
 False alarm
 – refer to Avoiding unintentional alarms [36](#)
 – refer to Switching off alarm [36](#)
 Fastening safety belts, refer to Safety belts [51](#)
 Fastest route for navigation [134](#)
 Fast forward
 – CD changer [164](#)
 – CD player [164](#)
 "Fast route" for navigation [134](#)
 "Favorites", calling up with radio [155](#)
 Filler neck for washer fluid [66](#)
 Filling bottle, refer to M Mobility System [212](#)
 Filter, refer to Microfilter/activated-charcoal filter [103](#)

Fine wood, refer to Caring for your vehicle brochure
 First aid, refer to First-aid kit [220](#)
 First-aid kit [220](#)
 Flashing, when locking and unlocking, refer to Setting confirmation signals [31](#)
 Flashlight, refer to Rechargeable flashlight [106](#)
 Flat tire
 – Flat Tire Monitor [84](#)
 – M Mobility System [212](#)
 – run-flat tires [87](#)
 – spare wheel [215](#)
 – Tire Pressure Monitor [86](#)
 – warning lamp [86, 87](#)
 Flat Tire Monitor [84](#)
 – false alarms [85](#)
 – initializing system [85](#)
 – limits of system [85](#)
 – snow chains [201](#)
 – warning lamp [86](#)
 Floor mats, refer to Caring for your vehicle brochure
 Floor mats/carpets, refer to Caring for your vehicle brochure
 Fluid reservoir, refer to Filler neck for washer fluid [66](#)
 "FM", reception range [148, 152](#)
 FM, waveband [152](#)
 Folding into raised position convertible top compartment floor, Convertible [35](#)
 Footbrake, refer to Braking safely [116](#)
 Footwell lighting, refer to Interior lamps [97](#)
 For specified oil grades, refer to Approved engine oils [205](#)
 For your own safety [6](#)
 Freeway, refer to Route criteria [134](#)
 Front airbags [89](#)

Front passenger airbags
 – deactivating [89](#)
 – deactivating, refer to Exception for front passenger seat [56](#)
 "FTM" [85](#)
 FTM, refer to Flat Tire Monitor [84](#)
 Fuel
 – average consumption [70](#)
 – display [69](#)
 – fuel specifications [195](#)
 – high-quality brands [195](#)
 – quality [195](#)
 – specifications [195](#)
 – tank contents, refer to Capacities [228](#)
 Fuel display, refer to Fuel gauge [69](#)
 Fuel filler door [194](#)
 – releasing in the event of electrical malfunction [194](#)
 Fuel gauge [69](#)
 Full mobile phone preparation package [170](#)
 Full screen display, refer to Switching assistance window off [20](#)
 Fuses [218](#)

G

Garage-door opener, refer to Integrated universal remote control [105](#)
 Gasoline
 – refer to Average fuel consumption [70](#)
 – refer to Fuel specifications [195](#)
 – refer to Required fuel [195](#)
 Gasoline display, refer to Fuel gauge [69](#)
 Gear changes [62](#)
 Gear display, refer to Displays in instrument cluster [62](#)
 Gearshift lever, manual transmission [60](#)

General driving notes [114](#)
Glove compartment [106](#)
– rechargeable flashlight [106](#)
GPS navigation, refer to
Navigation system [122](#)
Grills, refer to Ventilation [102](#)
Gross vehicle weight, refer to
Weights [228](#)
Ground clearance [116](#)

H

Handbrake [60](#)
– indicator lamp [13, 60](#)
Hands-free system, refer to
Microphone [14](#)
Hazard warning flashers [15](#)
"HD radio" [156](#)
HD radio, refer to High
Definition Radio [156](#)
Head airbags [89](#)
Headlamp control,
automatic [95](#)
Headlamp flasher [64](#)
Headlamps
– care, refer to Caring for your
vehicle brochure
– cleaning, refer to Wiper
system [65](#)
– cleaning tank, refer to
Capacities [228](#)
– filler neck for washer
fluid [203](#)
– replacing bulbs [209](#)
Head Light, refer to Adaptive
Head Light [96](#)
Head restraints
– front [49](#)
– removing [49](#)
– sitting safely [46](#)
"Head-Up Display" [54, 92](#)
Head-Up Display [91](#)
– default view [92](#)
– shift lights [63](#)
Heated
– mirrors [52](#)
– rear window [101](#)
– seats [51](#)

Heater [100](#)
Heating
– exterior mirrors [52](#)
– interior [99](#)
– rear window [101](#)
– residual heat utilization [102](#)
– seats [51](#)
Heating with engine switched
off, refer to Residual
heat [102](#)
Heavy cargo, refer to Securing
cargo [118](#)
Height, refer to
Dimensions [226](#)
Height adjustment
– seats [47](#)
– steering wheel [53](#)
High beams [97](#)
– headlamp flasher [97](#)
– indicator lamp [13](#)
– replacing bulbs [210](#)
High Definition Radio [156](#)
High water, refer to Driving
through water [115](#)
Hills [116](#)
Holder for cups [108](#)
"Home address" for
navigation system [134](#)
Homepage of BMW [4](#)
Hood [202](#)
Horn [10](#)
Hotel function [33](#)
– unlocking manually [34](#)
Hot exhaust system [115](#)
"Hour memo" [77](#)
"House number" for
destination entry [127](#)
Hydraulic brake assistant,
refer to Brake assistant [82](#)
Hydroplaning [115](#)
– also refer to Minimum tread
depth [199](#)

I
IBOC, refer to High Definition
Radio [156](#)
Ice, refer to Outside
temperature warning [69](#)
ID3-Tag, refer to Information
about track [162](#)
Identification mark
– recommended tire
brands [200](#)
– tire coding [198](#)
Idle [61](#)
iDrive [16](#)
– adjusting brightness [78](#)
– assistance window [20](#)
– changing date and time [77](#)
– changing language [79](#)
– changing menu page [19](#)
– changing settings [76](#)
– changing units of measure
and display form [78](#)
– controller [16](#)
– controls [16](#)
– displays, menus [17](#)
– operating principle [17](#)
– selecting menu item [19](#)
– selecting or confirming
entry [19](#)
– start menu [17](#)
– status information [20](#)
– symbols [18](#)
Ignition [58](#)
– switched off [59](#)
– switched on [58](#)
Ignition key, refer to Keys/
remote control [28](#)
Ignition key position 1, refer to
Radio readiness [58](#)
Ignition key position 2, refer to
Ignition on [58](#)
Ignition lock [58](#)
– starting engine with comfort
access [38](#)
i menu [17](#)
Imprint [2](#)

Indicator/warning lamps
 – ABS Antilock Brake System [83](#)
 – airbags [90](#)
 – brake system [83](#)
 – DSC [13](#), [82](#)
 – Flat Tire Monitor [86](#)
 – handbrake [13](#), [60](#)
 – MDrive [13](#), [54](#)
 – M Dynamic Mode [13](#), [82](#)
 – parking lamps/low beams [13](#)
 – safety belt warning [51](#)
 – TPM Tire Pressure Monitor [87](#)

Indicator and warning lamps, overview [13](#)

Inflation pressure, refer to Tire inflation pressure [196](#)

Inflation pressure monitoring
 – refer to Flat Tire Monitor [84](#)
 – refer to Tire Pressure Monitor [86](#)

Info menu [17](#)

Information
 – on another location [130](#)
 – on current position [130](#)
 – on town/city of destination [130](#)

"Information" for navigation system [130](#)

Information menu, refer to i menu [17](#)

"Information on destination" [131](#)

Information service [188](#)

"Info sources" [72](#)

Initializing
 – Flat Tire Monitor [85](#)
 – radio, refer to Storing stations [154](#)
 – refer to Power failure [217](#)
 – seat, mirror and steering wheel memory [48](#)
 – time and date [76](#)

"Input map" [129](#)

Installation location
 – CD changer [164](#)
 – drive for navigation DVD [122](#)

Instructions for navigation system, refer to Voice instructions [139](#)

Instrument cluster [12](#)

Instrument illumination, refer to Instrument lighting [97](#)

Instrument lighting [97](#)

Instrument panel, refer to Cockpit [10](#)

Instrument panel, refer to Instrument cluster [12](#)

Integrated key [28](#)

Integrated universal remote control [105](#)

Interesting destination for navigation [130](#)

"Interim time" [76](#)

Interior lamps [97](#)
 – switching on with remote control [31](#)

Interior motion sensor [36](#)
 – switching off [36](#)

Interior rearview mirror, automatic dimming feature [52](#)

Intermittent wiper mode [65](#)

J

Jacking points [216](#)

Joystick, refer to iDrive [16](#)

Jump starting [220](#)

K

Keyless-Go, refer to Comfort access [37](#)

Keyless opening and closing, refer to Comfort access [37](#)

Key Memory, refer to Personal Profile [29](#)

"Keypad" [180](#)

Keys [28](#)
 – key-related settings, refer to Personal Profile [29](#)
 – spare key [28](#)

Kick-down, refer to Drive mode [62](#)

Knee airbags [89](#)

Knock control [195](#)

L

Lamps, refer to Parking lamps/low beams [95](#)

Lamps and bulbs [209](#)

"Language / Units" [78](#)
 – for navigation system [123](#), [139](#)

"Languages" [79](#)
 – for navigation system [123](#), [139](#)

Lashing eyes, refer to Securing cargo [118](#)

Last destinations, refer to Destination list [131](#)

"Last seat pos." [49](#)

LATCH child restraint fixing system [57](#)

LEDs light-emitting diodes [209](#)

Length, refer to Dimensions [226](#)

License plate lamps, replacing bulbs [212](#)

Light-emitting diodes LEDs [209](#)

Lighter [108](#)

"Lighting" [65](#), [96](#)

Lighting
 – instruments [97](#)
 – lamps and bulbs [209](#)
 – of the vehicle, refer to Lamps [95](#)

Light switch [95](#)

"Limit" [75](#)

Loading, refer to Cargo loading [117](#)

Load securing equipment, refer to Securing cargo [118](#)

"Lock after driving" [33](#)

Lock buttons in the doors, refer to Locking [33](#)

Locking 31
 – confirmation signals 31
 – from inside 33
 – from outside 31
 – without key, refer to Comfort access 37

Locking and unlocking doors
 – confirmation signals 31
 – from inside 32
 – from outside 30

Low beams 95
 – automatic 95
 – indicator lamp 13
 – replacing bulbs 209

Lower back support, refer to Lumbar support 47

Lug bolts 215
 – tightening torque, refer to After mounting 216
 – wrench 215

Luggage compartment
 – capacity 228
 – emergency release 35
 – hotel function 33
 – increasing capacity, Convertible 35
 – opening/closing, refer to Luggage compartment lid 34
 – opening from inside 34
 – opening from outside 34
 – opening with remote control 31

Luggage compartment lid 34
 – comfort access 38
 – emergency operation 34
 – emergency release 35
 – opening from inside 34
 – opening from outside 34
 – opening with remote control 31, 34
 – unlocking manually 34

Lumbar support 47

LW, waveband 152

M

M Dynamic Mode MDM 82
 – indicator lamp 13, 82

M Engine Dynamic Control 64
 – "P 400" 64
 – "P 500" 64
 – "P 500 Sport" 64

M Mobility System 212

M+S tires, refer to Winter tires 200

Maintenance 207
 – refer to Service and Warranty Information Booklet for US models 207
 – refer to Service requirements 71
 – refer to Warranty and Service Guide Booklet for Canadian models 207

Maintenance system 207

Malfunction
 – convertible top 42
 – door lock 32
 – driver's door 32
 – fuel filler door 194
 – hotel function 34
 – luggage compartment lid 34

Malfunction warnings, refer to Check Control 73

Manual air distribution 101

"Manual" on the radio 153

Manual operation
 – convertible top 42
 – door lock 32
 – driver's door 32
 – fuel filler door 194
 – hotel function 34
 – luggage compartment lid 34

Manual transmission 60
 – tow-starting 223

"Map direction of travel" 138

"Map facing north" 138

Map for navigation
 – changing scale 138
 – destination entry 129

Map view 138

Map view facing north 138

Master key, refer to Keys/remote control 28

Maximum cooling 102

Maximum speed with winter tires 200

MDM, refer to M Dynamic Mode 82

"MDrive" 54

MDrive 54

"M Dynamic Mode" 82

Measurements, refer to Dimensions
 – Convertible 227
 – Coupe 226

Memory, refer to Seat, mirror and steering wheel memory 48

MENU, button refer to Start menu 17

Menus, refer to iDrive 16

Message list for traffic information 141

Microfilter 103

Microphone
 – for telephone 14
 – for voice command system 14

Mirror dimming feature 52

Mirrors 52
 – automatic curb monitor 52
 – folding in and out 52
 – heating 52
 – memory, refer to Seat, mirror and steering wheel memory 48

"Missed calls" 178

Missed calls 179

Mobile communications devices in vehicle 115

Mobile phone

- accepted calls [179](#)
- adjusting volume [176](#)
- calling [177](#)
- ending call [177](#)
- installation location, refer to Center armrest [107](#)
- missed calls [179](#)
- operation by voice [181](#)
- operation via iDrive [176](#)
- redialing [179](#)
- refer to separate operating instructions
- Top 8 [179](#)
- touch tone dialing, refer to Tone dialing method [180](#)

Mobile phone battery [184](#)

Mobile phones, use in vehicle, refer to Mobile communications devices in vehicle [115](#)

Mobile Service, refer to Roadside Assistance [220](#)

Mobility System [212](#)

Monitor, refer to iDrive [16](#)

Monitoring pressure of tires, refer to Flat Tire Monitor [84](#)

"Monitor on / off" [53](#)

Most recent mobile phone numbers [179](#)

MP3, compressed audio files [161](#)

Multifunction steering wheel, refer to Buttons on steering wheel [11](#)

Multifunction switch

- refer to Turn signals/headlamp flasher [64](#)
- refer to Wiper system [65](#)

Music tracks

- random play sequence [164](#)
- sampling, scan [163](#)

"Mute on / off" [53](#)

"M View" [92](#)

M view [93](#)

MW, waveband [152](#)

N

"Navigation" [70](#), [124](#)

Navigation destination

- entering manually [124](#)
- selecting via map [129](#)

Navigation drive, installation location [122](#)

Navigation DVD [122](#)

Navigation instructions, refer to Switching voice instructions on/off [139](#)

Navigation system [122](#)

- address book [132](#)
- bypassing route sections [140](#)
- destination entry [124](#)
- destination guidance in assistance window [122](#)
- destination list [131](#)
- displaying current position [144](#)
- displaying route [137](#)
- entering a destination manually [124](#)
- entering destination via voice [127](#)
- last destinations [131](#)
- looking for interesting destination [130](#)
- navigation DVD [122](#)
- route list [139](#)
- selecting destination using information [130](#)
- selecting destination via map [129](#)
- selecting route criteria [134](#)
- starting destination guidance [136](#)
- switching off, refer to Terminating/continuing destination guidance [136](#)
- terminating/continuing destination guidance [136](#)
- voice instructions [139](#)
- volume adjustment [140](#)

"Navigation voice instructions" [53](#), [123](#), [139](#)

Neck support, refer to Front head restraints [49](#)

"New address" for navigation system [132](#)

"New destination" [124](#), [129](#)

New remote controls [28](#)

"New route" [140](#)

New wheels and tires [200](#)

"Next entertainment source" [53](#)

"Normal" with EDC [84](#)

Nozzles

- refer to Ventilation [102](#)
- refer to Windshield washer nozzles [66](#)

Nylon rope, refer to Tow-starting and towing [221](#)

O

OBD socket, refer to Socket for OBD Onboard Diagnostics interface [208](#)

Octane ratings, refer to Fuel specifications [195](#)

Odometer [68](#)

Oil, refer to Engine oil [203](#)

Oil change intervals

- refer to Service requirements [71](#)
- refer to the Service and Warranty Information Booklet for US models or to the Warranty and Service Guide Booklet for Canadian models

"On a new destination" for navigation system [130](#)

"Onboard info" [70](#)

Onboard monitor, refer to iDrive [16](#)

Onboard tool kit [209](#)

"On destination" [130](#)

"On location" [130](#)

- Opening and closing
 - comfort access [37](#)
 - from inside [32](#)
 - from outside [30](#)
 - using door lock [32](#)
 - using the remote control [30](#)
- Operating principle, iDrive [17](#)
- Operation by voice for mobile phone [181](#)
 - adjusting volume [182](#)
 - canceling [181](#)
 - commands [181](#)
 - correcting phone number [182](#)
 - dialing phone number [182](#)
 - placing a call [182](#)
 - redialing [183](#)
 - voice phone book [182](#)
- "Options" [189](#)
- Orientation menu, refer to Start menu [17](#)
- Outside air, refer to AUC Automatic recirculated-air control [102](#)
- Outside temperature display [69](#)
 - changing unit of measure [78](#)
- Overview
 - operating principle [17](#)
 - radio control [148](#)
 - screen display [20](#)

P

- "P 400" [64](#)
- "P 500" [64](#)
- "P 500 Sport" [64](#)
- Panic mode [31](#)
- Park Distance Control PDC [80](#)
- "Parked car operation" [103](#)
- "Parked car ventilation" [103](#)
- Parked car ventilation
 - activating activation times [104](#)
 - setting activation time [103](#)
 - switching on and off directly [103](#)
- Parked car ventilation system, LED [99](#)
- Parking, vehicle [59](#)
- Parking aid, refer to PDC Park Distance Control [80](#)
- Parking assistant, refer to PDC Park Distance Control [80](#)
- Parking brake, refer to Handbrake [60](#)
- Parking lamps [95](#)
 - indicator lamp [13](#)
 - replacing bulbs [210](#)
- Parts and accessories [6](#)
- Passenger-side exterior mirror, tilting down [52](#)
- "Pathway lighting" [96](#)
- Pathway lighting [95](#)
- "PDC" [81](#)
- "PDC display on" [81](#)
- PDC Park Distance Control [80](#)
- Personal Profile [29](#)
- "Perspective" [138](#)
- "Phone" [172, 174, 177](#)
- Phone book [176](#)
 - changing entry [178](#)
 - creating and editing voice phone book [182](#)
 - deleting all entries [179](#)
 - deleting entry [179](#)
 - dialing phone number [178](#)
- Phone numbers
 - deleting from phone book [179](#)
 - dialing [177](#)
 - most recent numbers [179](#)
 - selecting in phone book [179](#)
 - Top 8 [179](#)
- Pinch protection system of power windows [40](#)
- Plasters, refer to First-aid kit [220](#)
- Plastic, refer to Caring for your vehicle brochure
- "Play" on the radio [159](#)
- Plugin unit for remote control, refer to Ignition lock [58](#)

- Pollen, refer to Microfilter/activated-charcoal filter [103](#)
- Position
 - displaying [144](#)
 - storing [132](#)
- "POWER" [54](#)
- POWER, refer to M Engine Dynamic Control [64](#)
- Power failure [217](#)
- Power windows, refer to Windows [38](#)
 - "Presets" on the radio [152, 158](#)
- Presetting parked car ventilation activation times [103](#)
- Pressure, tires [196](#)
 - producing with M Mobility System [212](#)
- Pressure monitoring of tires, refer to TPM Tire Pressure Monitor [86](#)
- "Profile" [191](#)
- Programmable button on steering wheel [53](#)
- Protective function, refer to Pinch protection system of windows [40](#)

R

- Radiator fluid, refer to
 - Coolant [205](#)
- Radio
 - Autostore [153](#)
 - controls [148](#)
 - High Definition Radio [156](#)
 - sampling stations [153](#)
 - satellite radio [157](#)
 - selecting frequency manually [153](#)
 - selecting waveband [148](#), [152](#)
 - station search [153](#)
 - station selection [152](#)
 - station with best reception [153](#)
 - storing stations [154](#)
 - switching on/off [148](#)
 - tone control [149](#)
 - volume [149](#)
 - Weather Band, refer to Weather news flashes [155](#)
- Radio key, refer to Keys/remote control [28](#)
- Radio position, refer to Radio readiness [58](#)
- Radio readiness [58](#)
 - switched off [59](#)
 - switched on [58](#)
 - with comfort access [38](#)
- Radio stations, storing [154](#)
- Rain sensor, windshield wiper system [65](#)
- "Random", random play sequence [164](#)
- "Random all" in audio mode [164](#)
- "Random directory" in audio mode [164](#)
- Random play sequence
 - CD changer [164](#)
 - CD player [164](#)
- "RDS" [155](#)
- Reading lamps [98](#)
- Rear lamps, refer to Tail lamps [211](#)
- Rearview mirrors, refer to Mirrors [52](#)
- Rear window
 - heating [101](#)
 - opening and closing [39](#)
- "Received calls" [178](#)
- Reception
 - quality [155](#)
 - radio stations [155](#)
 - regional station [153](#)
- Reception quality of mobile phone, refer to Status information [20](#)
- Rechargeable flashlight [106](#)
- Recirculated-air mode, refer to AUC Automatic recirculated-air control [102](#)
- Recirculation of air, refer to AUC Automatic recirculated-air control [102](#)
- Reclining seat, refer to Seats [47](#)
- Recording times, refer to Stopwatch [76](#)
- "Redial" for mobile phone [178](#)
- Redialing with mobile phone [183](#)
- Reflectors, refer to Tail lamps [211](#)
- Refueling [194](#)
- Releasing, hood [202](#)
- Releasing the locks, refer to Unlocking [37](#)
- "Relock door if not opened" [33](#)
- Remaining distance, refer to Cruising range [70](#)
- Remaining distance to destination, refer to Computer [70](#)
- Remote control [28](#)
 - battery replacement [38](#)
 - comfort access [37](#)
 - garage-door opener [105](#)
 - luggage compartment lid [31](#)
 - malfunction [31](#), [38](#)
- Removing condensation from windows [101](#)
- "Repeat directory" in audio mode [164](#)
- "Repeat" in audio mode [164](#)
- "Repeat track" in audio mode [164](#)
- Replacement fuses [218](#)
- Replacement remote control, refer to New remote controls [28](#)
- Replacing bulbs, refer to Lamps and bulbs [209](#)
- Replacing tires, changing a wheel [215](#)
- Reporting safety defects [7](#)
- Required fuel [195](#)
- Reserve warning, refer to Fuel gauge [69](#)
- "Reset" [85](#), [87](#)
 - stopwatch [76](#)
 - tone settings [151](#)
- Reset, refer to Resetting tone settings [151](#)
- "Reset to default" with MDrive [54](#)
- Residual heat [102](#)
- Restraint systems
 - for children [56](#)
 - refer to Safety belts [51](#)
- Retreaded tires [200](#)
- Reverse, fast
 - CD changer [164](#)
 - CD player [164](#)
- Reverse gear [61](#)
 - manual transmission [60](#)
- Road map [138](#)
- "Roadside Assistance" [180](#), [186](#)
- Roadside Assistance [220](#)
- Roadside parking lamps [97](#)
 - replacing bulbs, refer to Parking lamps [210](#)
- Rollover protection system on Convertible [91](#)
 - lowering [91](#)
- Rope, refer to Tow-starting and towing [221](#)
- Rotary/pushbutton, refer to iDrive [16](#)

Route [134](#)

- bypassing sections [140](#)
- changing [140](#)
- changing criteria [134](#)
- display [137](#)
- displaying arrow display [137](#)
- displaying map view [138](#)
- displaying streets or towns/cities [139](#)
- selecting [134](#)

Route information, refer to Destination guidance with voice instructions [139](#)

Route map, refer to Displaying map view [138](#)

"Route preference", changing [134](#)

Route selection [134](#)

Rubber parts, refer to Caring for your vehicle brochure

Run-flat tires

- continuing driving with a damaged tire [87](#)
- flat tire [87](#)

S

Safety belts [51](#)

- damage [51](#)
- indicator lamp [51](#)
- refer to Caring for your vehicle brochure
- reminder [51](#)
- sitting safely [46](#)

Safety belt tensioners, refer to Safety belts [51](#)

Safety systems

- ABS Antilock Brake System [81](#)
- airbags [89](#)
- driving stability control systems [81](#)
- rollover protection system, Convertible [91](#)
- safety belts [51](#)

Satellite radio [157](#)

- enabling channels [158](#)
- selecting channel [158](#)
- storing channel [158](#)

"SAT" with radio [148](#), [158](#)

"Save current destination" [134](#)

"Scan"

- music tracks on CD [163](#)
- stations with radio [153](#)

Scan

- CD changer [163](#)
- CD player [163](#)
- radio [153](#)

"Scan all" in audio mode [163](#)

"Scan directory" in audio mode [163](#)

Screw thread for tow fitting [221](#)

SDARS, refer to Satellite radio [157](#)

Seats [47](#)

- adjusting [47](#)
- adjusting backrest width [47](#)
- heating [51](#)
- lumbar support [47](#)
- memory, refer to Seat, mirror and steering wheel memory [48](#)
- sitting safely [46](#)
- storing the setting [48](#)
- thigh support [47](#)

Securing cargo [118](#)

- ski bag [110](#)

"Select as destination" [130](#), [189](#)

"Select current speed" [76](#)

Selecting audio sources, refer to Operating via iDrive [148](#)

Selecting frequency manually [153](#)

Selecting menu items [19](#)

Selecting route [134](#)

Selection options with navigation system [134](#)

Selector lever [61](#)

- manual transmission [60](#)

Selector lever lock, refer to Shiftlock [61](#)

Selector lever positions [61](#)

- manual transmission [60](#)

Sequential Manual Transmission with Drivelogic [61](#)

- Drivelogic driving programs [62](#)
- Drive mode [62](#)
- idle [61](#)
- initializing system, refer to After changing wheels/tires [201](#)
- kick-down [62](#)
- reverse gear [61](#)
- Sequential mode [61](#)
- shift lights [63](#)
- shiftlock [61](#)
- towing [222](#)
- tow-starting [223](#)

Sequential mode [61](#)

"Service" [72](#), [187](#)

Service, refer to Roadside Assistance [220](#)

Service and Warranty Information Booklet for US models [207](#)

Service Interval Display

- refer to CBS Condition Based Service [207](#)
- refer to Service requirements [71](#)

"Service notification" [187](#)

"Service Request" [180](#), [187](#)

"Service requirements" [72](#), [187](#)

Service requirements [71](#)

- refer to CBS Condition Based Service [207](#)

"Service Status" [191](#)

"Set"

- in audio mode [148](#)
- in trip computer [71](#)

"Set date" [78](#)

"Set service date" [73](#)

"Set time" [77](#)

Setting button, refer to Controls, controller [16](#)

"Settings" [191](#)

- for BMW Assist [189](#)
- for unlocking [30](#)

- Settings
 - changing on Control Display [76](#)
 - clock, 12h/24h mode [77](#)
 - configuring, refer to MDrive [54](#)
 - configuring, refer to Personal Profile [29](#)
 - date [78](#)
 - language [79](#)
 - units of measure [78](#)
- Settings menu, refer to i menu [17](#)
- Setting time, refer to Preselecting activation time [103](#)
- Shifting [62](#)
- Shift lights [63](#)
- Shiftlock [61](#)
- Shift paddles on steering wheel [62](#)
- Shock absorber control, refer to EDC Electronic Damping Control [84](#)
- Short commands of voice command system [229](#)
- "Short route" for navigation [134](#)
- Short route in navigation, refer to Selecting route [134](#)
- "Show current position" [129](#)
- "Show destination position" [129](#)
- Side airbags [89](#)
- Side marker lamps, replacing bulbs [211](#)
- Side turn signals, replacing bulbs [211](#)
- Signal horn, refer to Horn [10](#)
- Signaling a turn, triple turn signal activation [64](#)
- Sill panel lighting, refer to Interior lamps [97](#)
- Sitting safely [46](#)
 - with airbags [46](#)
 - with head restraints [46](#)
 - with safety belts [46](#)
- Ski bag [109](#)
- Slope assistant, refer to Starting off on slopes [115](#)
- SMG, refer to Sequential Manual Transmission with Drivelogic [61](#)
- "SMG Drivelogic" [54](#), [63](#)
- Snap-in adapter
 - mounting/removing [183](#)
 - using [170](#)
- Snow chains [201](#)
- Socket, refer to Connecting electrical devices [109](#)
- Socket for Onboard Diagnostics interface [208](#)
- Socket for remote control, refer to Ignition lock [58](#)
- Soft closure aid, refer to Automatic soft closing [34](#)
- Song search with CD, refer to Sampling tracks, scan [163](#)
- SOS, refer to Initiating an emergency call [219](#)
- Spare
 - adapter for spare key [28](#)
 - fuses [218](#)
 - key [28](#)
 - wheel, driving with spare wheel [217](#)
 - wheel, refer to Changing wheels [215](#)
- Special oils, refer to Approved engine oils [205](#)
- Speed-dependent volume [150](#)
- Speed limit warning, refer to Speed limit [75](#)
- Speedometer [12](#)
- "Speed volume", refer to Tone control [150](#)
- Speed with winter tires [200](#)
- "Sport" with EDC [84](#)
- Stability control, refer to Driving stability control systems [81](#)
- Start/Stop button [58](#)
 - starting the engine [59](#)
 - switching off the engine [59](#)
- "Start" for stopwatch [76](#)
- "Start guidance" [127](#), [136](#)
- Starting assistant, refer to Starting off on slopes [115](#)
- Starting difficulties, jump starting [220](#)
- Starting engine [59](#)
- Starting off
 - on a slippery surface [115](#)
 - on slopes [115](#)
- Start menu, iDrive [17](#)
- "Start route guidance" [129](#)
- "Start service" [186](#)
- "Start Service" for BMW Assist [188](#)
- "State / Province" for destination entry [125](#)
- "State inspection" [73](#)
- Station, refer to Radio [152](#)
- "Status" [72](#)
- Status information on Control Display [20](#)
- Status of this Owner's Manual at time of printing [5](#)
- Steering wheel
 - adjustment [53](#)
 - automatic adjustment, refer to Easy entry/exit [53](#)
 - automatic adjustment, refer to Steering wheel memory [48](#)
 - buttons on steering wheel [11](#)
 - lock, refer to Ignition lock [58](#)
 - MDrive button [54](#)
 - memory [48](#)
 - programmable button [53](#)
 - shift paddles [62](#)
 - "Steering wheel button" [53](#)
- Steering-wheel shift buttons, refer to Shift paddles [62](#)
- "Stop" for stopwatch [76](#)
- "Stopwatch" [76](#)
- Stopwatch [76](#)
- Storage compartments [107](#)
- "Store in address book" for navigation system [132](#)
- "Store" on the radio [154](#), [159](#)
- Storing current position [132](#)
- Storing radio stations [154](#)

Storing sitting position, refer to Seat, mirror and steering wheel memory [48](#)

Storing tires [201](#)

"Street" for destination entry [126](#)

Summer tires, refer to Wheels and tires [196](#)

"Surround Settings", refer to Tone control [150](#)

SW, waveband [152](#)

Switches, refer to Cockpit [10](#)

Switching on

– audio [148](#)

– CD changer [148](#)

– CD player [148](#)

– radio [148](#)

Swiveling headlamps, refer to Adaptive Head Light [96](#)

Symbols [4](#)

– indicator and warning lamps [13](#)

– navigation system [143](#)

– status information [20](#)

– traffic information with navigation system [140](#)

T

Tachometer [68](#)

Tail lamps [211](#)

– replacing bulbs [211](#)

Tank capacity

– also refer to Capacities [228](#)

– fuel tank capacity [194](#)

Target cursor for navigation [129](#)

Technical alterations, refer to For your own safety [6](#)

Technical data [226](#)

Telematics, refer to BMW Assist [185](#)

Telephone

– installation location, refer to Center armrest [107](#)

– refer to Mobile phone [170](#)

– refer to separate operating instructions

"Telephone list" [53](#)

TeleService [187](#)

Temperature

– adjusting in upper body region [101](#)

– adjusting with automatic climate control [100](#)

– changing units of measure [78](#)

– refer to Coolant temperature [68](#)

Temperature display

– changing units of measure [78](#)

– outside temperature [68](#)

– outside temperature warning [69](#)

Temperature gauge, engine oil [69](#)

Tempomat, refer to Cruise control [66](#)

"Terminate services" [190](#)

"Text language" [79](#)

"Theater", refer to Tone control [151](#)

The individual vehicle [5](#)

Tie-down points, refer to Securing cargo [118](#)

Tightening torque of the lug bolts, refer to After mounting [216](#)

Tilt alarm sensor [36](#)

– switching off [36](#)

Tilting down passenger-side exterior mirror [52](#)

"Time" [77](#)

"Time / Date" [77](#)

"Time format" [77](#)

Timer, refer to Preselecting activation time [103](#)

"Timer 1" for parked-car ventilation [103](#)

"Timer 2" for parked-car ventilation [103](#)

Tire inflation pressure [196](#)

Tire pressure loss [87](#)

Tire Pressure Monitor TPM [86](#)

Tire Quality Grading [198](#)

Tire replacement, new wheels and tires [200](#)

Tires

– age [198](#)

– air loss [86, 87](#)

– breaking-in [114](#)

– condition [199](#)

– damage [199](#)

– inflation pressure [196](#)

– minimum tread depth [199](#)

– M Mobility System [212](#)

– monitoring inflation pressure, refer to Flat Tire Monitor [84](#)

– new wheels and tires [200](#)

– pressure monitoring, refer to Tire Pressure Monitor [86](#)

– replacing [200](#)

– retreaded tires [200](#)

– size [197](#)

– size, refer to The right wheels and tires [200](#)

– wear indicators [199](#)

– wheel/tire combination [200](#)

– winter tires [200](#)

TMC station, refer to Traffic information [140](#)

"Tone" [149](#)

Tone dialing method [180](#)

Tone in audio mode

– adjusting [149](#)

– middle setting [151](#)

Tone on locking/unlocking [31](#)

Tools, refer to Onboard tool kit [209](#)

Top [40](#)

"Top 8" for mobile phone [178](#)

Torque, lug bolts, refer to After mounting [216](#)

Touch tone dialing, refer to Tone dialing method [180](#)

Tow bar [222](#)

Tow fitting [221](#)

Towing [221](#)
 – methods [222](#)
 – tow fittings [221](#)
 – with manual transmission [222](#)
 "Town / City" for destination entry [125](#)
 Tow rope [222](#)
 Tow-starting [221](#)
 "TPM" [87](#)
 TPM Tire Pressure Monitor [86](#)
 – resetting system [87](#)
 – system limits [86](#)
 – warning lamp [87](#)
 Tracks
 – finding [163](#)
 – random play sequence [164](#)
 – sampling on CD [163](#)
 – selecting with CD [162](#)
 Track width, refer to Dimensions [226](#)
 Traction control, refer to DSC Dynamic Stability Control [82](#)
 Traffic congestion
 – displaying traffic information [140](#)
 – refer to Bypassing route sections [140](#)
 Traffic information for navigation
 – depiction in route map [142](#)
 – displaying [141](#)
 – during destination guidance [143](#)
 – symbols [143](#)
 Traffic information with navigation [140](#)
 "Traffic Info settings" [141](#)

Transmission
 – breaking-in [114](#)
 – Drivelogic [62](#)
 – Drive mode [62](#)
 – idle [61](#)
 – kick-down, refer to Drive mode [62](#)
 – manual transmission [60](#)
 – reverse gear [61](#)
 – Sequential Manual Transmission with Drivelogic [61](#)
 – Sequential mode [61](#)
 – shift lights [63](#)
 – starting assistant, refer to Starting off on slopes [115](#)
 – towing [222](#)
 – tow-starting [223](#)
 Transporting children safely [56](#)
 Transport securing device, refer to Securing cargo [118](#)
 Tread depth, refer to Minimum tread depth [199](#)
 Treble, refer to Tone control [149](#)
 "Treble", tone control [149](#)
 "Trip computer" [71](#)
 Trip computer [71](#)
 Trip-distance counter, refer to Trip odometer [68](#)
 "Triple turn signal" [65](#)
 Trip odometer [68](#)
 Trunk, refer to Luggage compartment [35](#)
 Trunk lid, refer to Luggage compartment lid [34](#)
 Turning circle, refer to Dimensions [226](#)
 Turn signals [64](#)
 – replacing bulbs [210](#)

U

"Unchanged", with MDrive [55](#)
 Undercarriage protection, refer to Caring for your vehicle brochure
 Uniform Tire Quality Grading/UTQR [198](#)
 "Units" [78](#)
 Units
 – average fuel consumption [78](#)
 – temperature [78](#)
 Universal garage-door opener, refer to Integrated universal remote control [105](#)
 Universal remote control, refer to Integrated universal remote control [105](#)
 "Unlock button" [30](#)
 Unlocking
 – from inside [33](#)
 – from outside [30](#)
 – without key, refer to Comfort access [37](#)
 Unlocking without key, refer to Comfort access [37](#)
 "Update services" [189](#)
 Upshift display, refer to Shift lights [63](#)
 "USB" in audio mode [167](#)
 "Use current location as address" [132](#), [134](#)
 Used batteries
 – refer to Disposal [217](#)
 – refer to Replacing battery [38](#)
 Using turn signals [64](#)

V

Valve screw caps, refer to
After mounting **216**

Vehicle

- battery **217**
- breaking-in **114**
- care, refer to Caring for your vehicle brochure
- cargo loading **117**
- measurements, refer to Dimensions **226**
- parking **59**
- washing, refer to Caring for your vehicle brochure
- weights **228**

"Vehicle / Tires" for
unlocking **30**

Vehicle jack **215**

- jacking points **216**

Vehicle position, refer to
Displaying current
position **144**

Ventilation **102**

- draft-free **103**
- for cooling **103**
- parked car ventilation **103**

Vent outlets of automatic
climate control **99**

"Vent settings" **101**

Viscosity **205**

Voice, refer to Destination
guidance with voice
instructions **139**

Voice command system
- overview **22**

- short commands **229**

Voice instructions for
navigation system **139**

- muting **54**
- repeating **54, 140**
- switching on/off **54, 139**
- volume **140**

Voice phone book **182**

Volume **148**

- audio sources **148**
 - fuel tank, refer to Capacities **228**
 - luggage compartment **228**
 - mobile phone **176**
 - setting speed-dependent **150**
 - voice instructions **140**
 - windshield cleaning system, refer to Capacities **228**
- Volume adjustment in audio mode
- front-to-rear **150**
 - right/left **150**

W

Warning lamps, refer to
Indicator and warning
lamps **13**

Warning messages, refer to
Check Control **73**

Warning triangle **219**

Warranty and Service Guide
Booklet for Canadian
models **207**

Washer fluid

- capacity of the reservoir **66**
- wiper system **66**

Water on roads, refer to
Driving through water **115**

Waveband for radio **152**

"WB" **148, 156**

Wear indicators in tires, refer
to Minimum tread depth **199**

Weather news flashes **155**

Website BMW **4**

Weights **228**

Wheel/tire combination, refer
to New wheels and tires **200**

Wheel/tire damage **199**

Wheel/tire replacement, refer
to New wheels and tires **200**

Wheelbase, refer to
Dimensions **226**

Wheels and tires **196**

Width, refer to
Dimensions **226**

Wind deflector **44**

Windows **38**

- comfort closing with comfort access **37**
- comfort operation **31, 32**
- opening and closing, Convertible **39**
- opening and closing, Coupe **38**
- rear window, Convertible **39**

Windshield

- cleaning, refer to Wiper system **65**
- defrosting, refer to Defrosting windows **101**
- displays, refer to Head-Up Display **91**

Windshield wash

- automatic, refer to Rain sensor **65**
- capacities, reservoir **228**
- filler neck for washer fluid **203**
- nozzles **66**
- washer fluid **66**
- wiper system **65**

Windshield wipers, refer to
Wiper system **65**

- care, refer to Caring for your vehicle brochure
- replacing wiper blades **209**

Winter tires **200**

- setting speed limit **75**
- storage **201**

Wiper blades

- care, refer to Caring for your vehicle brochure
- replacing **209**

Wiper system **65**

- rain sensor **65**
- washer fluid **66**
- windshield washer nozzles **66**

"With highways" for
navigation system **134**

Wood decoration, refer to

Caring for your vehicle
brochure

Word matching principle for
navigation [135](#)

Working in the engine
compartment [202](#)

Wrenches/screwdrivers, refer
to Onboard tool kit [209](#)

X

Xenon lamps [209](#)

– replacing bulbs [209](#)

Y

Your individual vehicle

– programmable button on
steering wheel [53](#)

– settings, refer to MDrive [54](#)

– settings, refer to Personal
Profile [29](#)

More about BMW

bmwusa.com



The Ultimate
Driving Machine

01 41 0 013 314 ue

