

Owner's Manual for  
Vehicle



The Ultimate Driving  
Machine

## Contents A-Z





**750i**  
**750Li**  
**760Li**  
**750i xDrive**  
**750Li xDrive**

## **Owner's Manual for Vehicle**

Thank you for choosing a BMW.

The more familiar you are with your vehicle, the better control you will have on the road. We therefore strongly suggest:

Read this Owner's Manual before starting off in your new BMW. Also use the integrated Owner's Manual in your vehicle. It contains important information on vehicle operation that will help you make full use of the technical features available in your BMW. The manual also contains information designed to enhance operating reliability and road safety, and to contribute to maintaining the value of your BMW.

Supplementary information can be found in the additional brochures in the onboard literature.

We wish you a safe and enjoyable drive.

BMW AG

© 2009 Bayerische Motoren Werke  
Aktiengesellschaft  
Munich, Germany  
Reprinting, including excerpts, only with the written  
consent of BMW AG, Munich.  
English VIII/09, 09 09 510  
Printed on environmentally friendly paper, bleached  
without chlorine, suitable for recycling.

# Contents

The fastest way to find information on a particular topic or item is by using the [index](#), refer to [page 268](#).

## Using this Owner's Manual

6 Notes

## At a glance

12 Cockpit  
19 iDrive  
25 Voice activation system  
28 Integrated Owner's Manual in the vehicle

## Controls

32 Opening and closing  
47 Adjusting  
60 Transporting children safely  
64 Driving  
75 Displays  
85 Lamps  
90 Safety  
100 Driving stability control systems  
107 Driving comfort  
126 Climate control  
133 Interior equipment  
139 Storage compartments

## Driving tips

146 Things to remember when driving

## Navigation

154 Navigation

## Entertainment

170 Tone  
172 Radio  
179 CD/multimedia  
193 Rear entertainment  
198 Professional rear entertainment

## Communication

206 Telephone  
214 Contacts  
216 BMW Assist

## Mobility

224 Refueling  
225 Fuel  
226 Wheels and tires  
233 Engine compartment  
235 Engine oil  
237 Maintenance  
239 Replacing components  
245 Breakdown assistance  
250 Care

## Reference

256 Technical data  
260 Short commands for voice activation system  
268 Everything from A to Z

# Notes

## Using this Owner's Manual

The fastest way to find information on a particular topic is by using the index.

An initial overview of the vehicle is provided in the first chapter.

### Additional sources of information

Should you have any questions, your service center will be glad to advise you at any time.

Information on BMW, e.g., on technology, is available on the Internet: [bmwusa.com](http://bmwusa.com).

## Symbols

 Indicates precautions that must be followed precisely in order to avoid the possibility of personal injury and serious damage to the vehicle.

◄ Marks the end of a specific item of information.

\* Indicates special equipment, country-specific equipment and optional accessories, as well as equipment and functions not yet available at the time of printing.

"..." Identifies Control Display texts used to select individual functions.

>...< Verbal instructions to use with the voice activation system.

>>...<< Identifies the answers generated by the voice activation system.

 Refers to measures that can be taken to help protect the environment.

### Symbols on vehicle components

 Indicates that you should consult the relevant section of this Owner's Manual for information on a particular part or assembly.

## Your individual vehicle

You have decided in favor of a vehicle with individualized equipment and features.

This Owner's Manual describes the entire array of options and equipment available for a specific model.

As a result, the manual may contain accessories and equipment that you may not have specified for your own vehicle.

All options and special equipment are marked with an asterisk \*.

For options and equipment not described in this Owner's Manual, please refer to the Supplementary Owner's Manuals.

On right-hand drive vehicles, some controls are arranged differently than shown in the illustrations.

## Status at publication

The manufacturer of your vehicle pursues a policy of constant development that is conceived to ensure that our vehicles continue to embody the highest quality and safety standards. For this reason, it is possible that the features described in this Owner's Manual could differ from those on your vehicle.

## For your own safety

### Maintenance and repairs

Advanced technology, e.g., the use of modern materials and high-performance electronics, requires suitable maintenance and repair methods.

Therefore, have this work performed only by a BMW center or a workshop that works according to BMW repair procedures with appropriately trained personnel.

If this work is not carried out properly, there is the danger of subsequent damage and related safety hazards.

## Parts and accessories

BMW recommends using parts and accessories approved by BMW for this purpose.

Your BMW center is the right contact for genuine BMW parts and accessories, other products approved by BMW and related qualified advice.

BMW has tested these products for safety and suitability in relation to BMW vehicles.

BMW can assume responsibility for them. However, we cannot assume any responsibility whatsoever for parts and accessories that have not been specifically approved by BMW.

BMW cannot evaluate whether each individual product from another manufacturer can be used with BMW vehicles without presenting a safety hazard. This guarantee is also not applicable when country-specific government approval has been granted. Testing of this kind may fail to embrace the entire range of potential operating conditions to which components might be exposed on BMW vehicles. Such products could conceivably fail to comply with BMW's own stringent quality standards.

## Parts and Accessories

For your own safety, use genuine parts and accessories approved by BMW. When you purchase accessories tested and approved by BMW and Genuine BMW Parts, you simultaneously acquire the assurance that they have been thoroughly tested by BMW to ensure optimum performance when installed on your vehicle. BMW warrants these parts to be free from defects in material and workmanship. BMW will not accept any liability for damage resulting from installation of parts and accessories not approved by BMW. BMW cannot test every product made by other manufacturers to verify if it can be used on a BMW safely and without risk to either the vehicle, its operation, or its occupants. Genuine BMW Parts, BMW Accessories and other products approved by BMW, together with professional advice on using these items, are available

from all BMW centers. Installation and operation of non-BMW approved accessories such as alarms, radios, amplifiers, radar detectors, wheels, suspension components, brake dust shields, telephones, including operation of any mobile phone from within the vehicle without using an externally mounted antenna, or transceiver equipment, for instance, CBs, walkie-talkies, ham radios or similar accessories, may cause extensive damage to the vehicle, compromise its safety, interfere with the vehicle's electrical system or affect the validity of the BMW Limited Warranty. See your BMW center for additional information. Maintenance, replacement, or repair of the emission control devices and systems may be performed by any automotive repair establishment or individual using any certified automotive part.

## California Proposition 65 Warning

California laws require us to state the following warning:

Engine exhaust and a wide variety of automobile components and parts, including components found in the interior furnishings in a vehicle, contain or emit chemicals known to the State of California to cause cancer and birth defects and reproductive harm. In addition, certain fluids contained in vehicles and certain products of component wear contain or emit chemicals known to the State of California to cause cancer and birth defects or other reproductive harm. Battery posts, terminals and related accessories contain lead and lead compounds. Wash your hands after handling. Used engine oil contains chemicals that have caused cancer in laboratory animals. Always protect your skin by washing thoroughly with soap and water.

## Service and warranty

We recommend that you read this publication thoroughly. Your vehicle is covered by the following warranties:

- ▶ New Vehicle Limited Warranty
- ▶ Rust Perforation Limited Warranty
- ▶ Federal Emissions System Defect Warranty

- ▷ Federal Emissions Performance Warranty
- ▷ California Emission Control System Limited Warranty

Detailed information about these warranties is listed in the Service and Warranty Information Booklet for US models or in the Warranty and Service Guide Booklet for Canadian models.

Your vehicle has been specifically adapted and designed to meet the particular operating conditions and homologation requirements in your country and continental region in order to deliver the full driving pleasure while the vehicle is operated under those conditions. If you wish to operate your vehicle in another country or region, you may be required to adapt your vehicle to meet different prevailing operating conditions and homologation requirements. You should also be aware of any applicable warranty limitations or exclusions for such country or region. In such case, please contact Customer Relations for further information.

## Reporting safety defects

### For US customers

The following only applies to vehicles owned and operated in the US.

If you believe that your vehicle has a defect which could cause a crash or could cause injury or death, you should immediately inform the National Highway Traffic Safety Administration NHTSA, in addition to notifying BMW of North America, LLC, P.O. Box 1227, Westwood, New Jersey 07675-1227, Telephone 1-800-831-1117.

If NHTSA receives similar complaints, it may open an investigation, and if it finds that a safety defect exists in a group of vehicles, it may order a recall and remedy campaign.

However, NHTSA cannot become involved in individual problems between you, your dealer, or BMW of North America, LLC.

To contact NHTSA, you may call the Vehicle Safety Hotline toll-free at 1-888-327-4236 (TTY: 1-800-424-9153); go to [\[rcar.gov\]\(http://www.safercar.gov\); or write to: Administrator, NHTSA, 400 Seventh Street, SW., Washington, DC 20590. You can also obtain other information about motor vehicle safety from <http://www.safercar.gov>](http://www.safe-</a></p>
</div>
<div data-bbox=)

### For Canadian customers

Canadian customers who wish to report a safety-related defect to Transport Canada, Defect Investigations and Recalls, may telephone the toll-free hotline 1-800-333-0510, or contact Transport Canada by mail at: Transport Canada, ASFAD, Place de Ville Tower C, 330 Sparks Street, Ottawa ON K1A 0N5.







## At a glance

These overviews of buttons, switches and displays are intended to familiarize you with your vehicle. You will also become quickly acquainted with the available control concepts and options.

# Cockpit

## All around the steering wheel

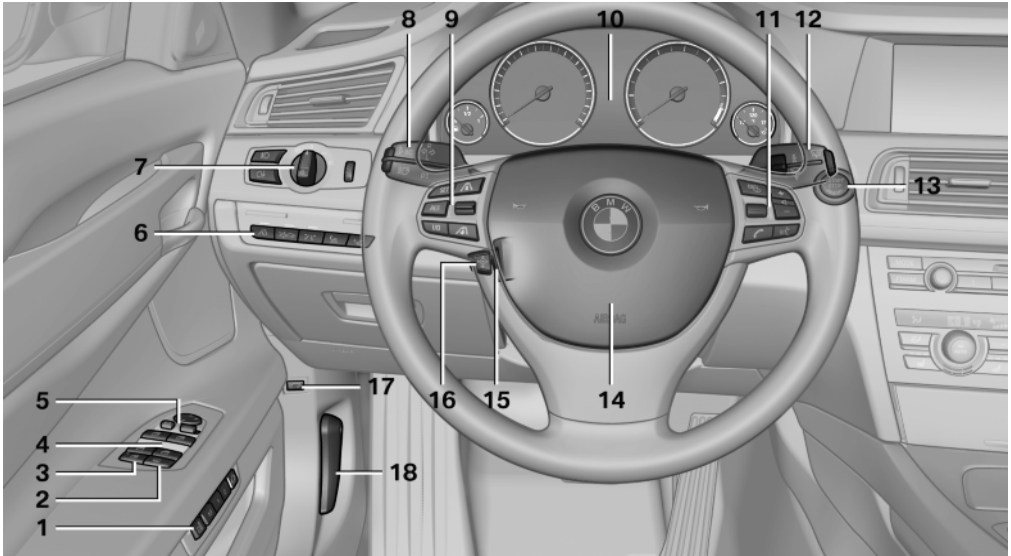

### 1 Seating comfort functions\*



Gentleman function\* 48



Seat, mirror, steering wheel memory\* 56



Active seat\* 49

2 Roller sun blind\* for rear window 44

3 Safety switch for the windows and the roller sun blind\* in the rear 44

4 Power windows 43

5 Exterior mirror operation 56

6 Driver assistance systems\*



Active Blind Spot Detection\* 98



Collision warning\* 112



Lane departure warning\* 96



Night Vision with pedestrian detection\* 121



Head-up Display\* 124

### 7 Lamps



Front fog lamps\* 88



Parking lamps 85



Low beams 85



Automatic headlamp control\* 86

Daytime running lights\* 86

High-beam assistant\* 87

Instrument lighting 88



**8** Steering column stalk, left



Turn signal 69



High beams, headlamp flasher 69



High-beam assistant\* 87



Roadside parking lamps 86



Computer\* 78

**9** Steering wheel buttons, left



Store speed 114, 108



Resume speed 115, 109



System on/off, interrupt 114, 107



Increase distance\* 109



Decrease distance\* 108

**10** Instrument cluster 14

**11** Steering wheel buttons, right



Entertainment source



Volume



Voice activation\* 25



Telephone\* 206

**12** Steering column stalk, right



Windshield wipers 69



Rain sensor\* 70



Clean the windshields and headlamps\* 69

**13**  Start/stop the engine and switch the ignition on/off 64

**14** Horn

**15**  Steering wheel heating\* 58

**16**  Adjust steering wheel 58

**17**  Open the trunk lid\* 39

**18** Unlock the hood

## Instrument cluster

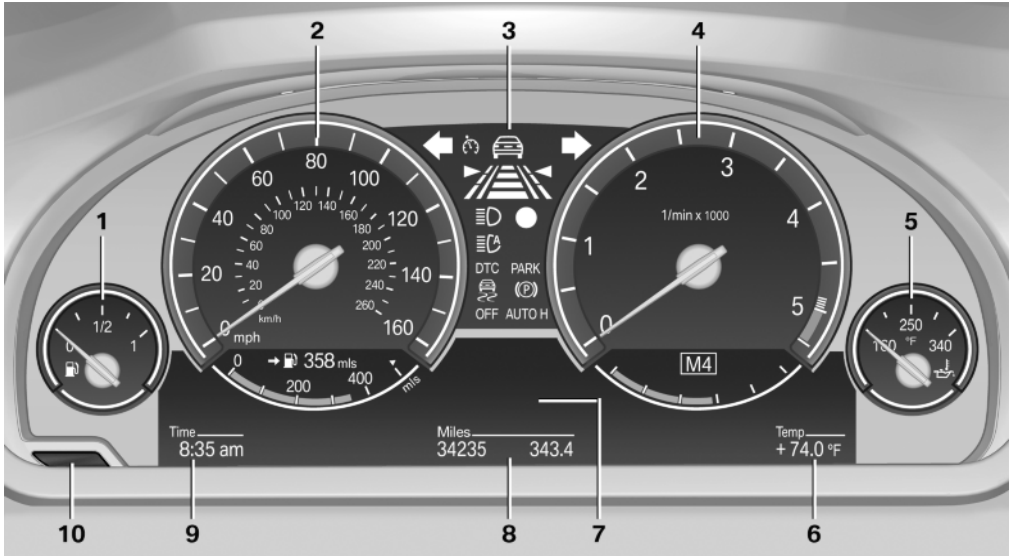

- |                                  |                           |
|----------------------------------|---------------------------|
| 1 Fuel gauge 77                  | 6 External temperature 75 |
| 2 Speedometer                    | 7 Electronic displays 16  |
| 3 Indicator and warning lamps 14 | 8 Miles, trip miles 75    |
| 4 Tachometer 76                  | 9 Clock 80                |
| 5 Engine oil temperature 76      | 10 Reset miles 75         |

## Indicator/warning lamps

### In the instrument cluster



















The indicator and warning lamps can light up in a variety of combinations and colors.

Several of the lamps are checked for proper functioning when the engine is started or the ignition is switched on, and light up briefly.

### Overview: indicator/warning lamps

Symbol	Function or system
	Turn signal
	Parking brake
	Automatic Hold
	Front fog lamps
	High beams

Symbol	Function or system
	High-beam assistant*
	Parking lamps, headlamp control
	Active Cruise Control*
	Vehicle detection, Active Cruise Control*
	Cruise control
	Lane departure warning*
	DSC Dynamic Stability Control
	DSC Dynamic Stability Control or DTC Dynamic Traction Control
	Tire Pressure Monitor Flat Tire Monitor
	Safety belts
	Airbag system

Symbol	Function or system
	Steering system
	Engine functions
	Brake system
	Brake system in Canadian models
	Antilock Brake System ABS
	Antilock Brake System ABS in Canadian models

### Text messages

Text messages in combination with a symbol in the instrument cluster explain a Check Control message and the meaning of the indicator and warning lamps.

### Supplementary text messages

Additional information on the Control Display, e.g., on the cause of a malfunction or the required action, can be called up via [Check Control](#), refer to [page 83](#).

The text of urgent messages is displayed automatically.

## Instrument cluster, electronic displays

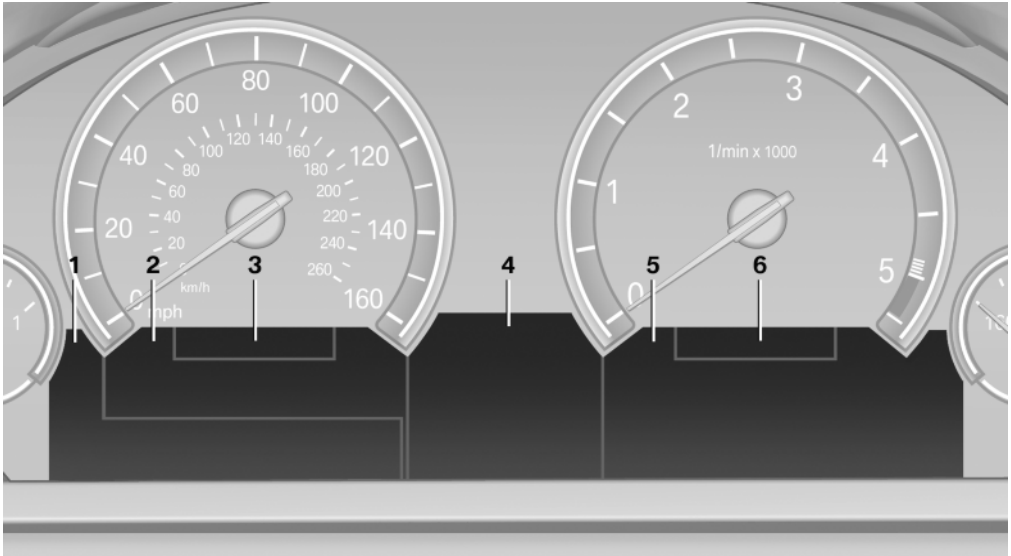

- |   |                                      |     |   |                             |    |
|---|--------------------------------------|-----|---|-----------------------------|----|
| 1 | Symbols and messages, e.g., warnings | 14  | 5 | Selection list, e.g., radio | 77 |
| 2 | Range                                | 77  | 6 | Transmission displays       | 73 |
| 3 | Computer*                            | 78  |   |                             |    |
| 4 | Navigation display*                  | 154 |   |                             |    |
|   | Service display                      | 82  |   |                             |    |



## All around the center console

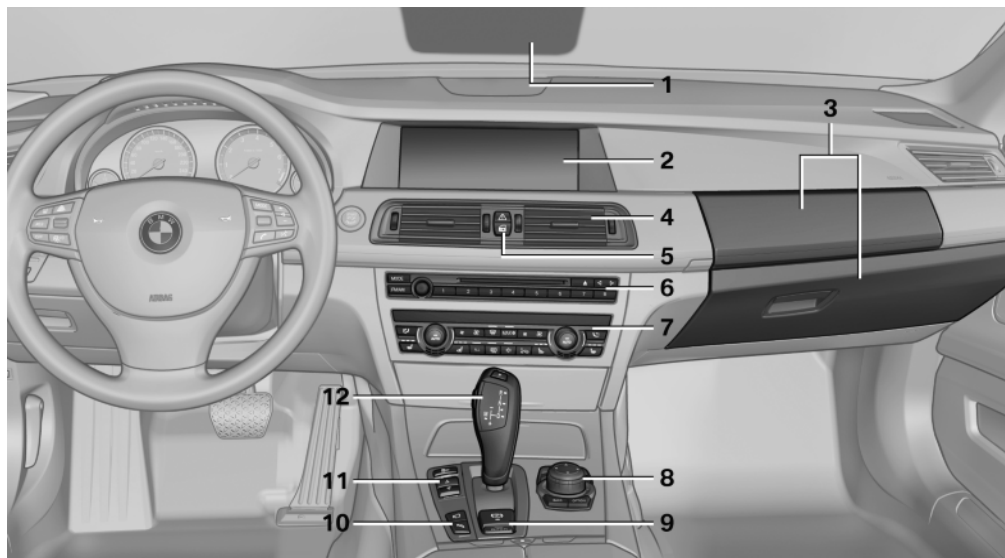

- 1 Headliner 18
- 2 Control Display 19
- 3 Glove compartment, top/bottom 139
- 4 Air vent 129
- 5  Hazard warning system 245







Central locking system 37

- 6 Radio 172  
DVD 179
- 7 Automatic climate control 126
- 8 Controller with buttons 19
- 9  Parking brake 65





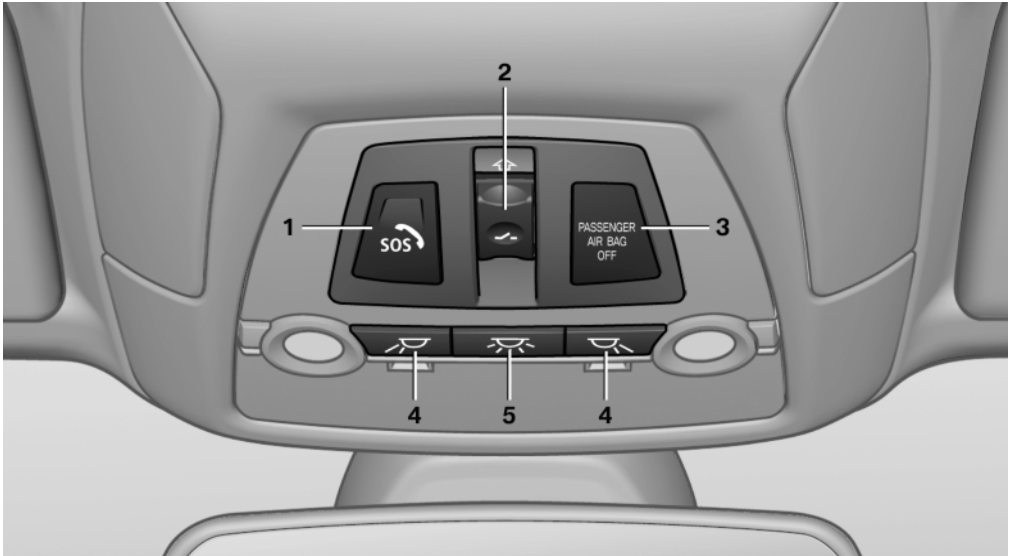

Auto Hold 67

- 10  PDC Park Distance Control\* 115  
Backup camera\* 118  
Side View\* 120
-  HDC Hill Descent Control\* 101
- 11  Dynamic Driving Control 103
-  DSC Dynamic Stability Control 103
- 12 Transmission selector lever

## All around the headliner



- |   |   |  |   |   |                   |
|---|---|--|---|---|-------------------|
| 1 |  | Emergency Request* 245                     | 4 |  | Reading lamps* 89 |
| 2 |  | Glass sunroof, powered* 45                 | 5 |  | Interior lamps 88 |
| 3 |  | Indicator lamp, front passenger airbag* 92 |   |   |                   |

## The concept

The iDrive combines the functions of a multitude of switches. Thus, these functions can be operated from a central location.



Using the iDrive during a trip

To avoid becoming distracted and posing an unnecessary hazard to your vehicle's occupants and to other road users, never attempt to use the controls or enter information unless traffic and road conditions allow this. ◀

## Controls at a glance

### Controls

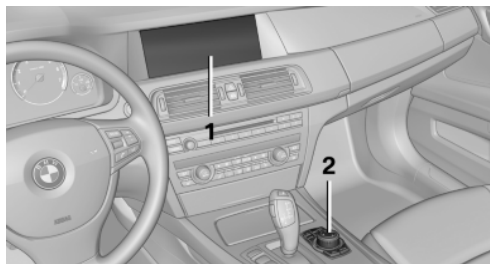

- 1 Control Display
- 2 Controller with buttons

The buttons can be used to open the menus directly. The controller can be used to select menu items and create the settings.

### Control Display

#### Notes

- To clean the Control Display, follow the [care instructions](#), refer to [page 252](#).
- Do not place objects close to the Control Display; otherwise, the Control Display can be damaged.

### Switching off

1.  Press the button.
2. "Switch off Control display"

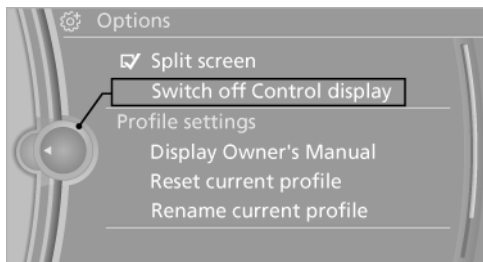

### Switching on

Press the controller again to switch the screen back on.

### Controller

Select menu items and create settings.

1. Turn.



2. Press.

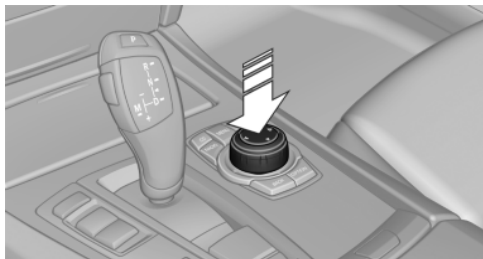

3. Move in four directions.

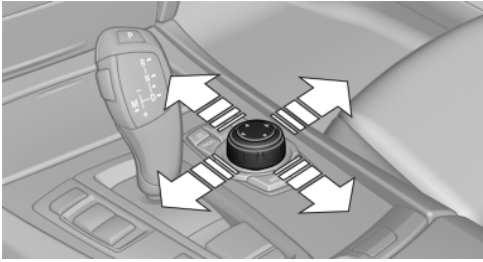

### Buttons on controller

Press the button	Function
MENU	Opens the main menu.
RADIO	Opens the Radio menu.
CD	Opens the CD/Multimedia menu.
NAVI	Opens the Navigation menu.
TEL	Opens the Telephone menu.
BACK	Displays the previous panel.
OPTION	Opens the Options menu.

## Operating concept

### Opening the main menu

 Press the button.

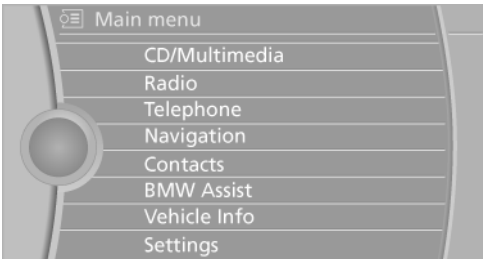

The main menu is displayed.

All iDrive functions can be called up via the main menu.

### Selecting menu items

Menu items shown in white can be selected.

1. Turn the controller until the desired menu item is highlighted.

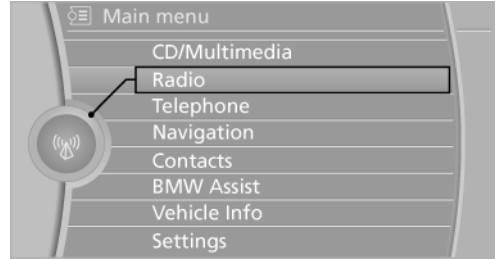

2. Press the controller.

### Menu items in the Owner's Manual

In the Owner's Manual, menu items that can be selected are set in quotation marks, e.g., "Settings".

### Changing between panels

After a menu item is selected, e.g., "Radio", a new panel is displayed. Panels can overlap.

- ▷ Move the controller to the left.  
The current panel is closed and the previous panel is displayed.  
The previous panel is opened again by pressing the BACK button. In this case, the current panel is not closed.
- ▷ Move the controller to the right.  
A new panel is opened on top of the previous display.

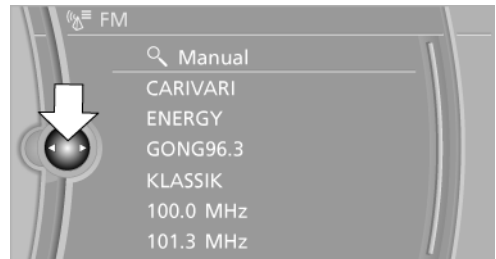

White arrows pointing to the left or right indicate that additional panels can be opened.

## View of an opened menu

When a menu is opened, it generally opens with the panel that was last selected in that menu. To display the first panel of a menu:

- ▶ Move the controller to the left repeatedly until the first panel is displayed.
- ▶ Press the menu button on the controller twice.

## Opening the Options menu

 Press the button.

The "Options" menu is displayed.

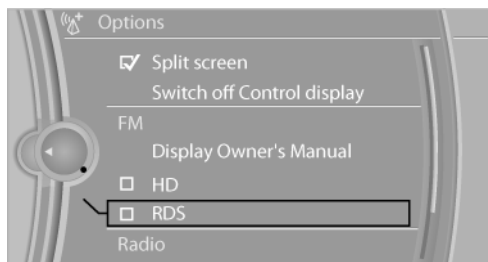

Additional options: move the controller to the right repeatedly until the "Options" menu is displayed.

## Options menu

The "Options" menu consists of various areas:

- ▶ Screen settings, e.g. "Split screen".  
This area remains unchanged.
- ▶ Control options for the selected main menu, e.g., for "Radio".
- ▶ If applicable, further operating options for the selected menu, e.g., "Store station".

## Changing settings

1. Select a field.

2. Turn the controller until the desired setting is displayed.

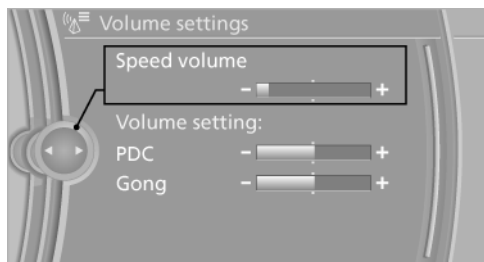

3. Press the controller.

## Activating/deactivating the functions

Several menu items are preceded by a check-box. It indicates whether the function is activated or deactivated. Selecting the menu item activates or deactivates the function.

- The function is activated.
- The function is deactivated.

## Example: setting the clock

### Setting the clock

1.  Press the button. The main menu is displayed.
2. Turn the controller until "Settings" is highlighted, and then press the controller.

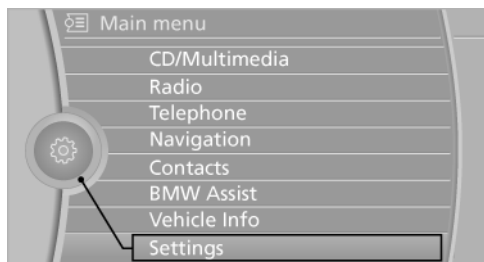

3. If necessary, move the controller to the left to display "Time/Date".

- Turn the controller until "Time/Date" is highlighted, and then press the controller.

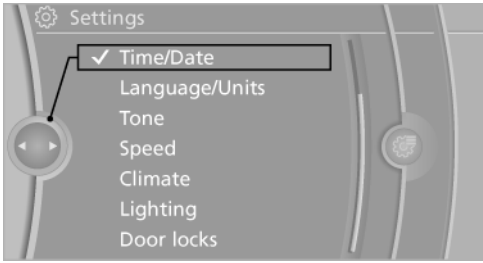

- Turn the controller until "Time:" is highlighted, and then press the controller.

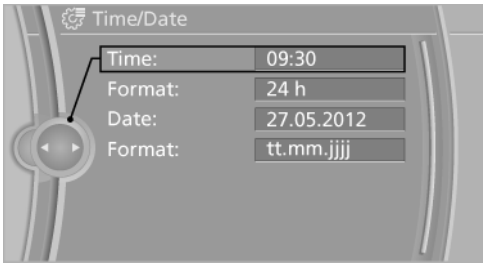

- Turn the controller to set the hours and press the controller.
- Turn the controller to set the minutes and press the controller.

## Status information

### Status field

The following information is displayed in the status field at the top right:

- ▷ Date.
- ▷ Current entertainment source.
- ▷ Sound output, on/off.
- ▷ Wireless network reception strength.
- ▷ Telephone status.
- ▷ Traffic bulletin reception.

### Status field symbols

The following information is displayed in the status field at the top right.

## Radio symbols

Symbol	Meaning
	Traffic bulletins* switched on. One of the symbols is displayed.
	HD Radio* switched on.
	Satellite radio* switched on



## Telephone symbols

Symbol	Meaning
	Incoming or outgoing call*
	Missed call*
	Wireless network reception strength*. Symbol flashes: network search
	Wireless network not available*
	Bluetooth* activated
	Roaming* is active
	SMS received*
	Check SIM card*
	SIM card* blocked
	SIM card* missing
	Enter PIN*

## Entertainment symbols

Symbol	Meaning
	CD/DVD player
	Music collection*
	Gracenote® database*
	AUX-IN port
	Rear AUX-IN port on left*
	Rear AUX-IN port on right*
	USB audio interface*

## Additional symbols

Symbol	Meaning
	Spoken instructions* switched off
	Request current vehicle position*

## Split screen\*

### General information

Additional information can be displayed on the right side of the split screen, e.g., information from the computer.

In the divided screen view, the so-called split screen, this information remains visible even when you change to another menu.

### Switching the split screen on and off

-  Press the button.
- "Split screen"

The split screen view is activated.

### Selecting the display

-  Press the button.
- "Split screen"
- Move the controller until the split screen is selected.
- Select one of the following settings:
  - ▷ "Onboard info"
  - ▷ "Trip computer"
  - ▷ "Entertainment details"

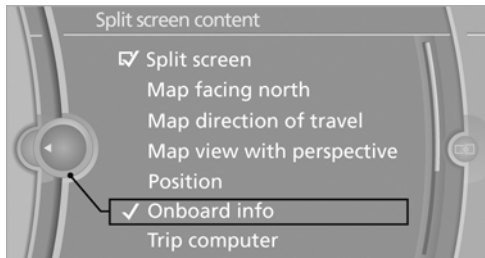



## Programmable memory buttons



### General information

The iDrive functions can be stored on the programmable memory buttons and called up directly, e.g., radio stations, navigation destinations, phone numbers and entry points into the menu.

### Saving a function

- Highlight the function via the iDrive.
- ... Press the desired button for more than 2 seconds.

### Running a function

- ... Press the button. The function will run immediately. This means, for example, that the number is dialed when a phone number is selected.

### Displaying the button assignment

Use a finger to touch the buttons. Do not wear gloves or use objects.

The key assignment is displayed at the top edge of the screen.

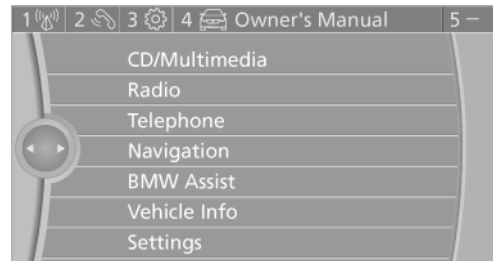

- ▷ To display short information: touch the button.
- ▷ To display detailed information: touch the button for an extended period.



### Deleting the button assignments

- Press buttons 1 and 8 simultaneously for approx. five seconds.

2. "OK"

## Entering letters and numbers

1. Turn the controller: select letters or numbers.
2. Select additional letters or numbers if needed.
3. "OK": confirm the entry.

Symbol	Function
	Press the controller: delete the letter or number.
	Press the controller for an extended period: delete all letters or numbers.
	Enter a blank space.

## Switching between letters and numbers

Depending on the menu, you can switch between entering letters and numbers:

Symbol	Function
<b>A<sup>B</sup>C</b>	Enter the letters.
<b>1<sup>2</sup>3</b>	Enter the numbers.

## Wordmatch concept during navigation

Entry of names and addresses: the selection is narrowed down every time a letter is entered and letters may be added automatically.

Destination search: the entries are continuously compared to the data stored in the vehicle.

- ▷ The only letters offered for entering addresses are those for which data are available.
- ▷ Town/city names can be entered with the spelling used in any of the languages available on the Control Display.



# Voice activation system\*

## The concept

- ▶ The voice activation system can be used to operate equipment by means of spoken commands.
- ▶ The system encompasses special microphones on the outer edge of the headliner.
- ▶ Most menu items on the Control Display can be voiced as commands. The system prompts you to make your entries.
- ▶ ›...‹ Verbal instructions to use with the voice activation system.

## Requirements

Set the language via the iDrive. The selected language also applies to the voice activation system.

Set the iDrive language, refer to page 81.

## Using voice activation

### Activating the voice activation system

1.  Press the button on the steering wheel.
2. Say the command.  
The command is displayed in the instrument cluster.

 This symbol in the instrument cluster indicates that the voice activation system is active. If no further commands are available, continue operating the equipment via the iDrive.

### Terminating the voice activation system

Briefly press the button on the steering wheel or ›Cancel‹.

## Possible commands

### Having possible commands read aloud

The commands available in each case depend on the menu item selected on the Control Display.

Have the available spoken instructions read aloud using ›Voice commands‹.



If, for example, "CD" is selected, the commands for operating the CD/multimedia are read aloud.

### Executing functions using short commands

Some functions can be performed directly by means of short commands, irrespective of which menu item is currently selected, e.g., ›Map‹.

List of [short voice activation commands](#), refer to page 260.

## Example: playing back a CD

1. Switch on the Entertainment sound output if necessary.
2.  Press the button on the steering wheel.
3. ›C D and multimedia‹  
The medium last played is played back.
4.  Press the button on the steering wheel.
5. ›C D track ...‹ e.g., CD track 4.

## Setting the voice dialog

You can set whether the system should use the standard dialog or a shorter variant.

In the shorter variant of the voice dialog, the prompts and responses from the system are abbreviated.

1. "Settings"
2. "Language/Units"
3. "Speech mode:"
4. Select the setting.

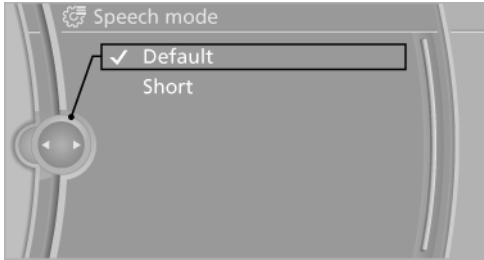

## Adjusting the volume

Turn the volume button while giving an instruction until the desired volume is set.

- ▷ The volume remains constant even if the volume of other audio sources is changed.
- ▷ The volume is stored for the remote control currently in use.

## Notes on Emergency Requests

Do not use the voice activation system to initiate an Emergency Request. In stressful situations, the voice and vocal pitch can change. This can unnecessarily delay the establishment of a telephone connection.

Instead, use the [SOS button\\*](#), refer to [page 245](#), in the vicinity of the interior mirror.

## Environmental conditions

- ▷ Say the commands, numbers, and letters smoothly and with normal volume, emphasis, and speed.
- ▷ Always say commands in the language of the voice activation system.
- ▷ When selecting a radio station, use the common pronunciation of the station name.

- ▷ Keep the doors, windows, and glass sunroof closed to prevent noise interference.
- ▷ Avoid making other noise in the vehicle while speaking.

## Notepad

Around 10 minutes of spoken text can be stored, in sections of any length or as a whole.

### Recording a note

1. "Notepad"
2. "Record new note"
3. Say the text.
4.  Press the button on the steering wheel.

When recording notes, the ›Cancel‹ command is not available.

- ▷ Any spoken text can be used in a note.
- ▷ It is not necessary to avoid certain command words.

### Reading the highlighted note

1. Highlight the note.
2. ›Read selected note‹

### Sampling the recorded note

1. "Notepad"
2. Select the note.
3. ›Read note‹  
The first three seconds of the note are read out.

### Deleting notes

1. "Notepad"
2. Select the note.
3. "Delete note" or "Delete all notes"

### Exporting notes

1. "Notepad"
2. Select the note.

3. "Save to USB device" or "Save notes to USB device"
4. Confirm the selection.

# Integrated Owner's Manual in the vehicle

## Owner's Manual in the vehicle

The Owner's Manual can be displayed on the Control Display in accordance with the equipment selected.

### Methods of opening the Owner's Manual

The following methods are available:

- ▷ Quick Reference: "Quick reference"
- ▷ Key word search: "Owner's Manual"
- ▷ Using pictures: "Search by pictures"

1.  Press the button.
2. Turn the controller: open "Vehicle Info".
3. Press the controller.
4. Select "Quick reference", "Search by pictures" or "Owner's Manual".

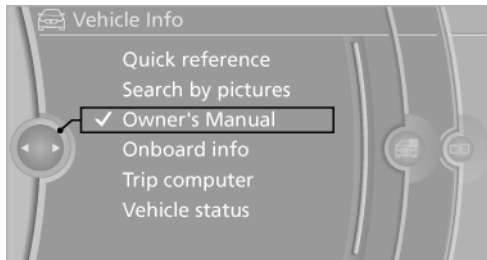

### Leafing through the Owner's Manual

#### Page by page with link access

Turn the controller until the next or previous page is displayed.

#### Page by page without link access

Leaf through the pages directly while skipping the links.

Highlight the symbol once. Now simply press the controller to leaf from page to page.



Leaf back.



Leaf forward.

### Context-sensitive help - Section of the Owner's Manual referring to the present function

The relevant information can be opened directly.

### Opening via the iDrive

To move directly from the application on the Control Display to the options menu:

1.  Press the button or move the controller to the right repeatedly until the "Options" menu is displayed.
2. "Display Owner's Manual"



### Opening when a Check Control message is displayed

Directly from the Check Control message on the Control Display:

"Display Owner's Manual"

### Changing between a function and the Owner's Manual

To change from a function, e.g., radio, to the Owner's Manual on the Control Display and to switch between the two displays:

1.  Press the button or move the controller to the right repeatedly until the "Options" menu is displayed.
2. "Display Owner's Manual"
3. Select the desired page in the Owner's Manual.
4.  Press the button again to return to the function displayed last.
5.  Press the button to return to the page of the Owner's Manual displayed last.



To switch back and forth repeatedly between the function displayed last and the page of the Owner's Manual displayed last, repeat steps 4 and 5. This opens a new panel every time.

## Programmable memory buttons



### General information

The Owner's Manual can be stored on the [programmable memory buttons](#), refer to page 23, and called up directly.

### Storing

1. Select "Owner's Manual" via the iDrive.
2. ... Press the desired button for more than 2 seconds.

### Executing

1. ... Press the button.  
The Owner's Manual is displayed immediately.



## Controls

This chapter is intended to provide you with information that will give you complete control of your vehicle. All features and accessories that are useful for driving and your safety, comfort and convenience are described here.

# Opening and closing

## Remote control/key

### Scope of delivery

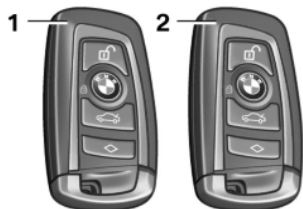

- 1 Remote control with key
- 2 Remote control with key

### Buttons on the remote control

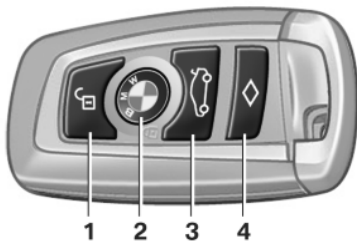

- 1 Releasing
- 2 Locking
- 3 Opening the trunk lid
- 4 Panic mode\*, headlamp courtesy delay feature

### General information

Every remote control contains a replaceable battery.

The settings called up and implemented when the vehicle is unlocked depend on which remote control is used to unlock the vehicle, [Personal Profile](#), refer to page 33.

In addition, information about service requirements is stored in the remote control, [Service data in the remote control](#), refer to page 237.

## Integrated key

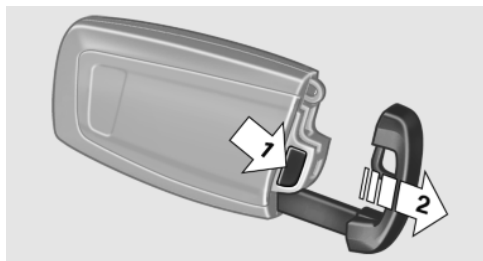

Press the button on the back of the remote control, arrow 1, and pull out the key, arrow 2.

The integrated key fits the following locks:

- ▷ Driver's door.
- ▷ Trunk lid.
- ▷ Storage compartment under the front center armrest.

The storage compartment contains a [switch for separately securing the trunk lid](#), refer to page 40.

## Replacing the battery

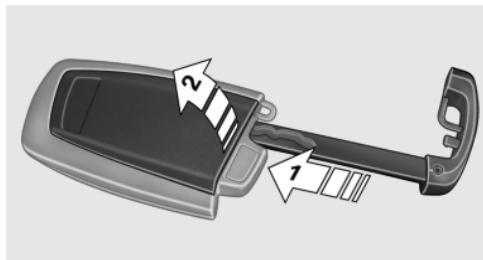

1. Take the integrated key out of the remote control.
2. Press in the notch, arrow 1, using the key, for example.
3. Remove the cover of the battery compartment; see arrow 2.
4. Insert a battery of the same type with the positive side facing upwards.
5. Press the cover closed.





Take the used battery to a recycling center or to your service center.

## New remote controls

You can obtain new remote controls from your service center.

## Loss of the remote controls

Lost remote controls can be blocked by your service center.

## Emergency detection of remote control

It is possible to switch on the ignition or start the engine in situations such as the following:

- ▷ Remote control malfunction.
- ▷ Interference of radio transmission to remote control by external sources.
- ▷ Discharged battery in the remote control.

A message is displayed on the Control Display if an attempt is made to switch on the ignition or start the engine.

## Starting the engine in case of emergency detection of remote control



If a corresponding message appears on the Control Display, as shown, hold the remote control against the marked area on the steering column and press the Start/Stop button within 10 seconds while depressing the brake.

# Personal Profile

## The concept

You can set several of your vehicle's functions to suit your personal needs and preferences.

- ▷ The settings are automatically saved in the profile currently activated.
- ▷ The remote control used is detected when the vehicle is unlocked and the stored profile is called up.
- ▷ Your personal settings will be recognized and called up again even if the vehicle has been used in the meantime by someone else with another remote control.

The individual settings are stored for up to three remote controls.

## Transmitting the settings

Your personal settings can be taken with you to another vehicle equipped with the Personal Profile function. For more information, contact your service center.

Transmission takes place via:

- ▷ The USB interface in the glove compartment onto a USB device.

## Profile management

### Opening the profiles

A different profile can be called up than the one associated with the remote control currently in use.

1. "Settings"
2. "Profiles"

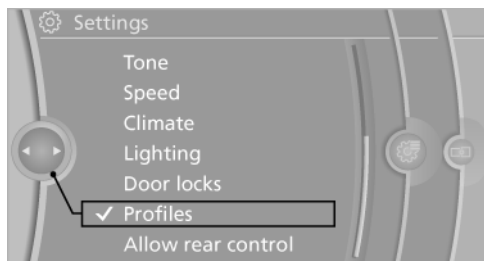

3. Select a profile.

## Renaming profiles

1. "Settings"
2. "Profiles"
3. The current profile is selected.
4. Open "Options".
5. "Rename current profile"

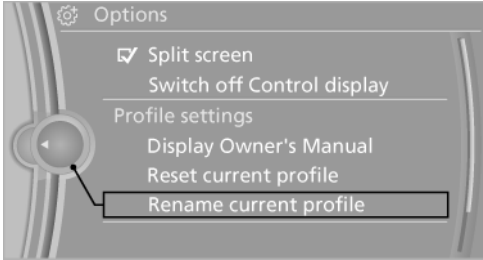

## Resetting profiles

The settings of the active profile are reset to their default values.

1. "Settings"
2. "Profiles"
3. The current profile is selected.
4. Open "Options".
5. "Reset current profile"

## Importing profiles

Existing settings and contacts are overwritten with the imported profile.

1. "Settings"
2. "Profiles"
3. "Import profile"

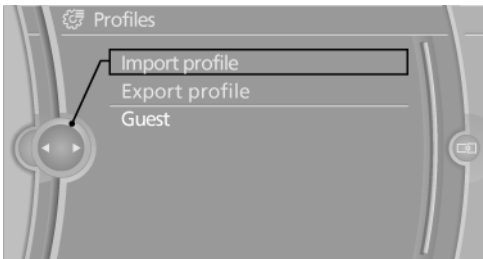

4. USB interface, refer to page 139: "USB device"

## Exporting profiles

Most settings of the active profile and the saved contacts can be exported.

1. "Settings"
2. "Profiles"
3. "Export profile"
4. USB interface, refer to page 139: "USB device"

## Personal Profile settings

The following functions and settings can be stored in a profile.

More information on the settings can be found under:

- ▷ Active Cruise Control: [collision warning](#), refer to page 112.
- ▷ Exterior mirror position, refer to page 56.
- ▷ CD/Multimedia, refer to page 179: audio source listened to last.
- ▷ Dynamic Driving Control: [sport program](#), refer to page 104.
- ▷ Driver's seat position, refer to page 47.
- ▷ Programmable memory buttons, refer to page 23: assignment.
- ▷ Head-up Display, refer to page 124: selection, brightness and position of display.
- ▷ Headlamp courtesy delay feature, refer to page 85: time setting.
- ▷ Tone, refer to page 170: tone settings.
- ▷ Automatic climate control, refer to page 126: settings.
- ▷ Steering wheel position, refer to page 58.
- ▷ Navigation, refer to page 154: map views, route criteria, voice output on/off.
- ▷ Night Vision with pedestrian detection, refer to page 121: selection of functions and type of display.
- ▷ Daytime running lights\*, refer to page 86: current setting.
- ▷ Park Distance Control PDC, refer to page 171: adjusting the signal tone volume.

- ▷ **Radio**, refer to page 172: stored stations, station listened to last, special settings.
- ▷ **Backup camera**, refer to page 118: selection of functions and type of display.
- ▷ **Side View**, refer to page 120: selection of functions and type of display.
- ▷ **Language on the Control Display**, refer to page 81.
- ▷ **Lane departure warning**, refer to page 96: last setting, on/off.
- ▷ **Active Blind Spot Detection**, refer to page 98: last setting, on/off.
- ▷ **Triple turn signal activation**, refer to page 69.
- ▷ **Locking the vehicle**, refer to page 38: after a brief period or after starting to drive.

## Central locking system

### The concept

The central locking system becomes active when the driver's door is closed.

The system simultaneously engages and releases the locks on the following:

- ▷ Doors.
- ▷ Trunk lid.
- ▷ Fuel filler door.

### Operating from the outside

- ▷ Via the remote control.
- ▷ Via the driver's door lock.
- ▷ Via the door handles\*.
- ▷ Via the button in the trunk lid\*.

The following takes place simultaneously when locking/unlocking the vehicle via the remote control:

- ▷ Anti-theft protection is switched on/off. Doors cannot be unlocked using the lock buttons or the door opener.
- ▷ The welcome lamps, interior lamps and courtesy lamps\* are switched on and off.

- ▷ The **alarm system\***, refer to page 41, is armed or disarmed.

### Operating from the inside

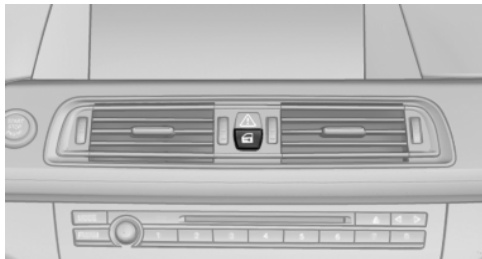

Via the button for the central locking system.

If the vehicle has been locked from inside, the fuel filler door remains unlocked.

If an accident of a certain severity occurs, the central locking system unlocks automatically.

The hazard warning system and interior lamps come on.

## Opening and closing: from the outside

### Using the remote control

#### General information



Take the remote control with you

People or animals left unattended in a parked vehicle can lock the doors from the inside. Always take the remote control with you when leaving the vehicle so that the vehicle can then be opened from the outside. ◀

### Releasing



Press the button.

The vehicle is unlocked.

You can set how the vehicle is to be unlocked. The setting is stored for the remote control currently in use.

1. "Settings"
2. "Door locks"

### 3. "Unlock button:"

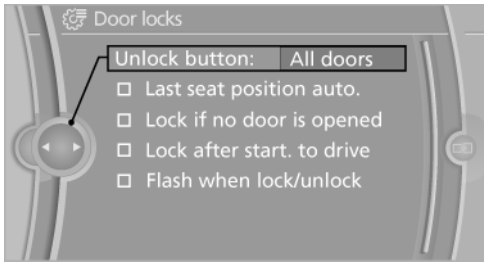

### 4. Select the desired function:

- ▷ "Driver's door only"  
Only the driver's door and the fuel filler door are unlocked. Pressing again unlocks the entire vehicle.
- ▷ "All doors"  
The entire vehicle is unlocked.

### Comfort opening

The remote control can be used to simultaneously open the windows and the glass sunroof\*.

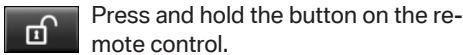

The windows and the glass sunroof\* open. Releasing the button stops the motion.

### Locking

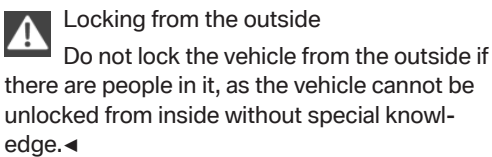
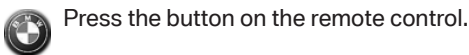

### Switching on the interior lamps, courtesy lamps\*, and welcome lamps

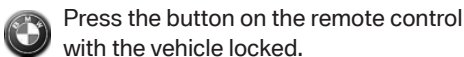

### Panic mode\*

You can trigger the alarm system if you find yourself in a dangerous situation.

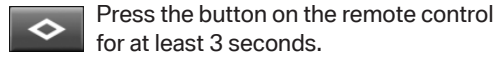

To switch off the alarm: press any button.

### Switching on the headlamp courtesy delay feature

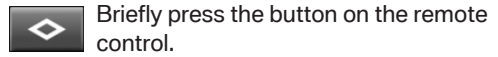

The duration, refer to page 85, can be set via the iDrive.

### Opening the trunk lid

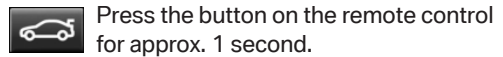

The trunk lid opens, regardless of whether it was previously locked or unlocked. During opening, the trunk lid pivots back and up. Ensure that adequate clearance is available before opening.

To avoid locking yourself out of the vehicle, do not place the remote control into the trunk. The trunk lid is locked again as soon as it is pushed closed.

### Confirmation signals from the vehicle

1. "Settings"
2. "Door locks"
3. "Flash when lock/unlock"

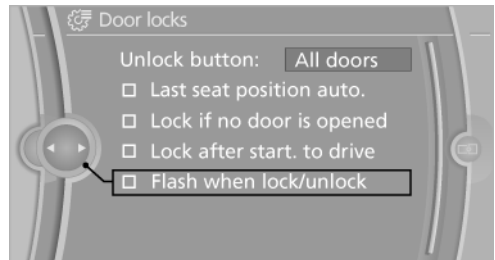

### Malfunction

Local radio waves may interfere with the remote control.

If the vehicle can no longer be locked or unlocked with the remote control, the battery is

discharged. [Replace the battery, refer to page 32.](#)

If this occurs, unlock or lock the vehicle at the door lock using the key.

### For US owners only

The transmitter and receiver units comply with part 15 of the FCC/Federal Communication Commission regulations. Operation is governed by the following:

FCC ID:

- ▷ LX8766S.
- ▷ LX8766E.
- ▷ LX8CAS.
- ▷ LX8CAS2.
- ▷ MYTCAS4.

Compliance statement:

This device complies with part 15 of the FCC Rules. Operation is subject to the following two conditions:

- ▷ This device may not cause harmful interference, and
- ▷ this device must accept any interference received, including interference that may cause undesired operation.

Any unauthorized modifications or changes to these devices could void the user's authority to operate this equipment.

## Using the door lock

### General information

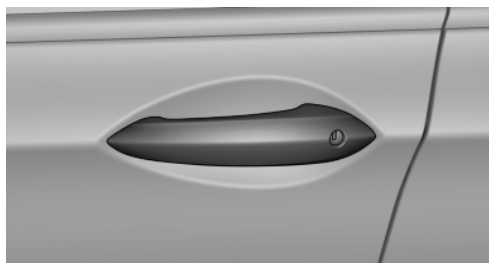

-  Locking from the outside  
Do not lock the vehicle from the outside if there are people in it, as the vehicle cannot be

unlocked from inside without special knowledge. ◀

-  Remove the key before pulling the door handle

Before pulling the outside door handle, remove the key to avoid damaging the paintwork and the key. ◀

In some country-specific versions, the [alarm system\\*](#), refer to page 41, is triggered if the vehicle is unlocked via the door lock.

Unlock the vehicle using the remote control to switch off the alarm.

### Convenience operation\*

The door lock can be used to simultaneously operate the windows and the glass sunroof\*.

### Opening/closing

With the door closed, turn the key to the Unlock or Lock position and hold it there.

Turning the key back to the original position stops the motion.

-  Monitor the closing process  
Monitor the closing process to ensure that no one becomes trapped; otherwise, injuries may result. ◀

### Manual operation

If an electrical malfunction occurs, lock or unlock the vehicle using a key via the door lock on the driver's door.

## Opening and closing: from the inside

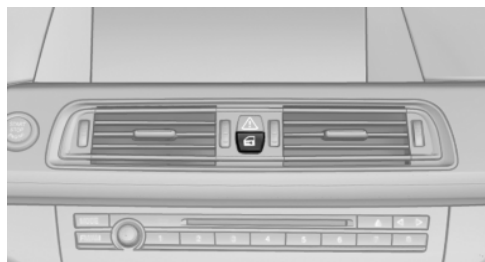

## Locking and unlocking



Press the button in the vehicle.

The doors and the trunk lid are locked or unlocked when the front doors are closed, but they are not secured against theft.

The fuel filler door remains unlocked.

## Automatic locking

The setting is stored for the remote control currently in use.

1. "Settings"
2. "Door locks"
3. Select the desired function:
  - ▷ "Lock if no door is opened"
 

The vehicle locks automatically after a short period of time if a door is not opened.
  - ▷ "Lock after start. to drive"
 

The vehicle locks automatically after you drive away.

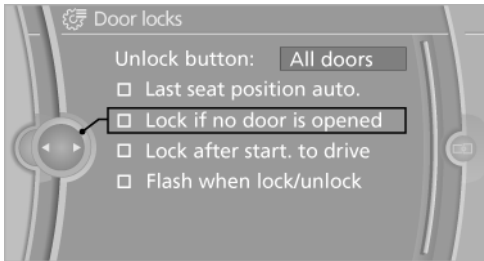

## Doors

### Automatic Soft Closing

To close the doors, push lightly.

It is closed automatically.



**Danger of pinching**

Make sure that the closing path of the doors is clear; otherwise, injuries may result. ◀

## Trunk lid

### Opening

During opening, the trunk lid pivots back and up.

Ensure that adequate clearance is available before opening.

### Opening from the outside



- ▷ Press the button on the trunk lid.
- ▷  Press the button on the remote control for approx. 1 second.

### Opening from the inside



Press the button on the A-pillar in the vehicle.

If the vehicle is stationary, the trunk lid opens if it is not locked.

### Manual release

All of the vehicle's keys fit the trunk lid lock, located in the license plate recess.

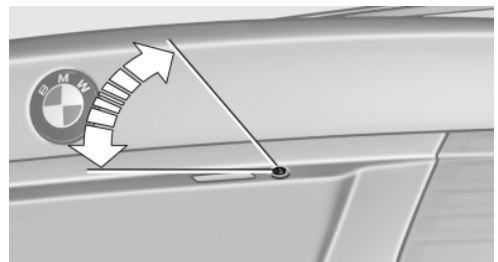

Turn the key all the way to the left. The trunk lid unlocks.

To avoid locking yourself out of the vehicle, do not place the key or remote control in the trunk.

The trunk lid is locked again as soon as it is pushed closed.

If the trunk lid is opened via the lock with the alarm system armed, the alarm is triggered.

Therefore, unlock the vehicle first.

If the alarm has been triggered accidentally: [switch off the alarm, refer to page 41](#).

## Closing



Recessed grips in the interior trim of the trunk lid make it easier to pull down the lid.



**Danger of pinching**

Make sure that the closing path of the trunk lid is clear; otherwise, injuries may result. ◀

## Automatic Soft Closing

To close it completely, push the trunk lid down lightly.

It is closed automatically.

## Locking the vehicle\*



Press the button on the inside of the trunk lid. The vehicle is locked completely.

## Automatic trunk lid operation\*

### Opening

The trunk lid opens fully.



- ▶ Press the button on the exterior of the trunk lid.
- ▶  Press the button on the remote control or in the driver's footwell.

Pressing the button again stops the motion.

The opening process is interrupted as well:

- ▶ When the vehicle starts moving.
- ▶ By pressing the button on the inside of the trunk lid.

### Closing



- ▶ Press the button on the inside of the trunk lid. The trunk lid closes automatically. Pressing again stops the motion.

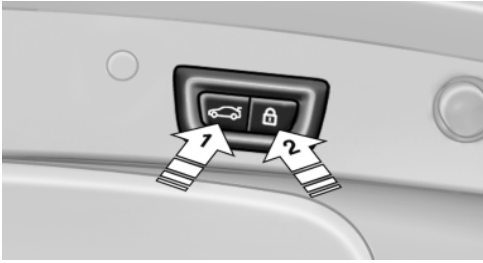

With Comfort Access:

- ▷ Press the button, arrow 1, on the inside of the trunk lid.  
The trunk lid closes automatically.  
Pressing again stops the motion.
- ▷ Press the button, arrow 2.  
The trunk lid closes automatically and the vehicle is locked.



- ▷ Press the button on the exterior of the trunk lid.  
Pressing again stops the motion.
- ▷  Press and hold the button on the remote control.  
Releasing the button stops the motion.

The closing process is not interrupted when the vehicle starts moving.

## Manual operation

If an electrical malfunction occurs:

1. [Manually unlock the trunk lid, refer to page 38.](#)
2. Open or close the trunk lid slowly and smoothly.

## Locking separately

The trunk lid can be locked separately using the switch in the front center armrest.

In this case, it is independent of the central locking system.



- ▷ Trunk lid secured, arrow 1.
- ▷ Trunk lid not secured, arrow 2.

If the center armrest is locked, the remote control can be handed out without the key. The vehicle cannot be accessed via the trunk lid. This is advantageous at hotels, for example.

## Emergency unlocking\*



Pull the handle inside the trunk.

The trunk lid unlocks.

## Comfort Access\*

### The concept

The vehicle can be accessed without activating the remote control.

All you need to do is to have the remote control with you, e.g., in your jacket pocket.

The vehicle automatically detects the remote control when it is nearby or in the passenger compartment.

Comfort Access supports the following functions:

- ▷ Unlocking/locking of the vehicle.
- ▷ Unlocking of the trunk lid separately.
- ▷ Starting the engine.



## Functional requirements

- ▷ To lock the vehicle, the remote control must be located outside of the vehicle.
- ▷ The next unlocking and locking cycle is not possible until after approx. 2 seconds.
- ▷ The engine can only be started if the remote control is inside the vehicle.

## Comparison with ordinary remote control

The functions can be controlled by pressing the buttons or via Comfort Access.

## Releasing

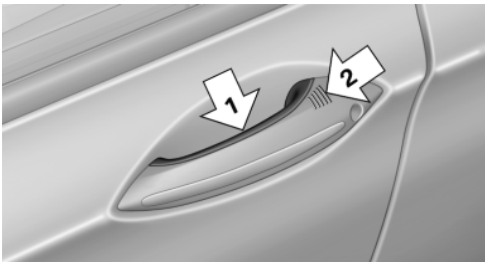

Fully grasp a door handle, arrow 1. This corresponds to pressing the  button.

## Locking

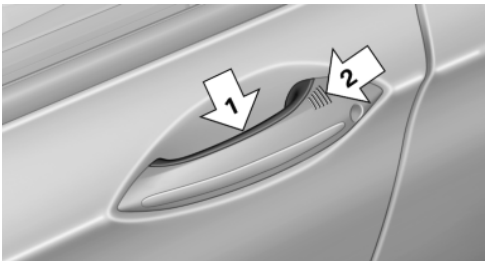

Press the area on the door handle, arrow 2, with your finger for approx. 1 second.

This corresponds to pressing the  button.

To save battery power, ensure that the ignition and all electronic systems and/or power consumers are switched off before locking the vehicle.

## Unlocking the trunk lid separately

Press the button on the exterior of the **trunk lid**, refer to page 38.

This corresponds to pressing the  button. If a remote control accidentally left in the trunk is detected in the locked vehicle, then the trunk lid opens again.

## Ignition on

Pressing the Start/Stop button switches the ignition on.

When doing so, do not depress the brake pedal; otherwise, the engine will start.

## Malfunction

Comfort Access may not function properly if it experiences interference from local radio waves, e.g., mobile phones.

If this occurs, open or close the vehicle using the buttons on the remote control or use a key in the door lock.

To subsequently start the engine, hold the remote control against the marked **area on the steering column**, refer to page 33.

## Alarm system\*

### The concept

The vehicle alarm system responds to:

- ▷ Opening of a door, the hood or the trunk lid.
- ▷ Movements in the vehicle: **interior motion sensor**, refer to page 42.
- ▷ Changes in the vehicle tilt, e.g., during attempts to steal a wheel or tow the car.
- ▷ Interruptions in battery voltage.

The alarm system briefly indicates tampering:

- ▷ By sounding an acoustic alarm.
- ▷ By switching on the hazard warning system.
- ▷ By flashing the high beams.

## Arming and disarming the alarm system

When you lock or unlock the vehicle, either with the remote control or at the door lock, the alarm system is armed or disarmed at the same time.

### Door lock and armed alarm system

Unlocking via the door lock will trigger the alarm on some country-specific versions.

This alarm can only be ended by pressing the button on the remote control.

### Trunk lid and armed alarm system

The trunk lid can be opened using the remote control, even if the alarm system is armed.

- ▷  Press the button on the remote control for approx. 1 second.

After the trunk lid is closed, it is locked and monitored again by the alarm system. The hazard warning system flashes once.

### Panic mode\*

- ▷  Press the button on the remote control for at least 3 seconds.

### Switching off the alarm

- ▷ Unlock the vehicle using the remote control.
- ▷ Unlock the vehicle via the door lock using the key\*.
- ▷ With Comfort Access: If you are carrying the remote control with you, pull on the door handle.

## Indicator lamp on the interior rearview mirror



- ▷ The indicator lamp flashes briefly every 2 seconds:  
The system is armed.
- ▷ The indicator lamp flashes after locking:  
The doors, hood or trunk lid is not closed properly, but the rest of the vehicle is secured.  
After 10 seconds, the indicator lamp flashes continuously. The interior motion sensor is not active.
- ▷ The indicator lamp goes out after unlocking:  
The vehicle has not been tampered with.
- ▷ The indicator lamp flashes after unlocking until the engine is started, but no longer than approx. 5 minutes:  
An alarm has been triggered.

### Tilt alarm sensor

The tilt of the vehicle is monitored.

The alarm system responds in situations such as attempts to steal a wheel or tow the car.

### Interior motion sensor

The windows and glass sunroof must be closed for the system to function properly.

### Avoiding unintentional alarms

The tilt alarm sensor and interior motion sensor can be switched off together, such as in the following situations:

- ▷ In duplex garages.
- ▷ During transport on car-carrying trains, at sea or on a trailer.

- ▷ When animals are to remain in the vehicle.

## Switching off the tilt alarm sensor and interior motion sensor



Press the button on the remote control twice in succession.

The indicator lamp lights up for approx. 2 seconds and then flashes continuously.

The tilt alarm sensor and interior motion sensor are switched off until the vehicle is locked again.

## Power windows

### General information





Take the remote control with you

Take the remote control with you when leaving the vehicle so that children, for example, cannot operate the power windows and injure themselves. ◀



### Opening

- ▷  Press the switch to the resistance point.  
The window opens while the switch is held.
- ▷  Press the switch beyond the resistance point.  
The window opens automatically.



Pressing again stops the motion.

### Closing



Danger of pinching

Monitor the closing process and make sure that the closing path of the window is clear; otherwise, injuries may result. ◀

- ▷  Pull the switch to the resistance point.  
The window closes while the switch is held.
  - ▷  Pull the switch beyond the resistance point.  
The window closes automatically.
- Pressing the switch stops the motion.

Convenience operation, refer to page 36, via the remote control or the door lock.

### Pinch protection system

If the closing force exceeds a specific value as a window closes, the closing action is interrupted.

The window reopens slightly.



Danger of pinching even with pinch protection

Even with the pinch protection system, check that the window's closing path is clear; otherwise, the closing action may not stop in certain situations, e.g., if thin objects are present. ◀



Window accessories

Do not install any accessories in the range of movement of the windows; otherwise, the pinch protection system will be impaired. ◀

### Closing without the pinch protection system

For example, if there is an external danger or if ice on the windows prevents a window from closing normally, proceed as follows:

1. Pull the switch past the resistance point and hold it there.  
Pinch protection is limited and the window reopens slightly if the closing force exceeds a certain value.
2. Pull the switch past the resistance point again within approx. 4 seconds and hold it there.  
The window closes without pinch protection.

## Safety switch

The following functions can be locked simultaneously, using the switch:

- ▷ Opening and closing of the rear windows using the switches in the rear.
- ▷ Operation of the roller sun blinds\* using the switches in the rear.
- ▷ Adjustment of the power rear seats\*.
- ▷ Adjustment of the power head restraints\* in the rear.

## Switching on and off



Press the button.

The LED lights up if the safety function is switched on.



Safety switch for rear operation

Press the safety switch when transporting children in the rear; otherwise, injury may result if the windows are closed without supervision. ◀

To deactivate the function, the vehicle must be in at least the radio ready state.

## Roller sunblinds\*

### General information

The safety switch in the driver's door can be used to prevent children, for example, from operating the roller blinds using the switches in the rear.

Press the safety switch in the driver's door. The LED lights up if the safety function is switched on.

If you are no longer able to move the roller blinds after having activated them consecutively a number of times, the system is blocked for a limited time to prevent overheating. Let the system cool.

The roller sunblinds cannot be moved at low interior temperatures.

## Driver's door controls



### Roller blind for rear window



Press the button.

### Rear door controls



### Roller blind for the side windows



Press the button.

The roller blind can only be extended or retracted when the side window is closed.

### Roller blind for rear window



Press the button.

### Raising and lowering the roller blinds together



Press and hold the button.

# Glass sunroof, powered\*

## General information

The glass sunroof and the sliding visor can be operated together or separately, using the same switch.

The glass sunroof is operational when the ignition is switched on.



**Danger of pinching**

Monitor the closing process and make sure that the closing path of the glass sunroof is clear; otherwise, injuries may result. ◀



**Take the remote control with you**

Take the remote control with you when leaving the vehicle so that children, for example, cannot operate the roof and injure themselves. ◀



## Raising the glass sunroof



Press the switch briefly.

▷ The closed roof is raised and the sliding visor opens slightly.

▷ The opened roof closes until it is in its raised position. The sliding visor stays completely open.

Pressing the switch again closes the sliding visor almost completely.



**Sliding visor with raised roof**

Do not use force to close the sliding visor, as this may damage the mechanism. ◀

## Opening/closing the sliding visor

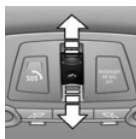

▷ Press the switch in the desired direction to the resistance point and hold it there.

The sliding visor moves while the switch is being held.

▷ Press the switch in the desired direction past the resistance point.

The sliding visor moves automatically.

Briefly pressing the switch stops the motion.

## Opening/closing the glass sunroof and sliding visor together

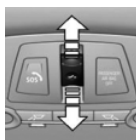

Press the switch twice in the desired direction past the resistance point.

The glass sunroof and sliding visor move together. Pressing the switch again stops the motion.

**Convenience operation, refer to page 36**, via the remote control or the door lock.

## Pinch protection system

If the closing force when closing the glass sunroof exceeds a certain value, the closing movement is stopped, beginning at approximately the middle of the opening in the roof, or from the raised position during closing.

The glass sunroof opens again slightly.



**Danger of pinching even with pinch protection**

Despite the pinch protection system, check that the roof's closing path is clear; otherwise, the closing action may not be interrupted in certain extreme situations, such as when thin objects are present. ◀

## Closing without the pinch protection system

For example, if there is an external danger, proceed as follows:

1. Press the switch forward beyond the resistance point and hold.

Pinch protection is limited and the roof re-opens slightly if the closing force exceeds a certain value.

2. Press the switch forward again beyond the resistance point and hold until the roof closes without pinch protection.

### **Initializing after a power failure**

After a power failure, it is only possible to raise the roof, if necessary.

Have the system initialized by your service center.

# Adjusting

## Sitting safely

The ideal seating position can make a vital contribution to relaxed, fatigue-free driving.

The seating position plays an important role in an accident in combination with:

- ▷ Safety belts, refer to page 52.
- ▷ Head restraints, refer to page 53.
- ▷ Airbags, refer to page 90.

## Front seats

### Adjusting



Do not adjust the seat while driving

Never attempt to adjust the driver's seat while driving.

The seat could respond with unexpected movement and the ensuing loss of vehicle control could lead to an accident. ◀



Do not incline the backrest too far to the rear

Do not incline the backrest on the front passenger side too far to the rear during driving. Otherwise, there is the danger of sliding under the safety belt in an accident. This would eliminate the protection normally provided by the belt. ◀

### At a glance

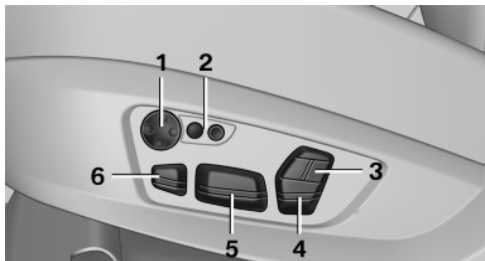

- 1 Lumbar support\*
- 2 Backrest width\*
- 3 Shoulder support\*

- 4 Backrest
- 5 Forward/back, height, tilt
- 6 Thigh support\*

### Adjustments in detail

1. Forward/back.

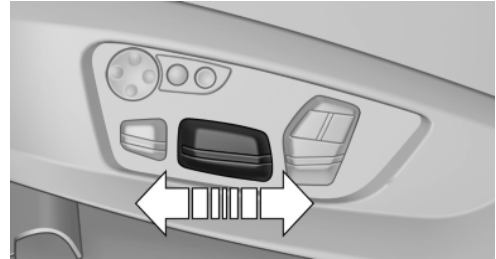

2. Height.

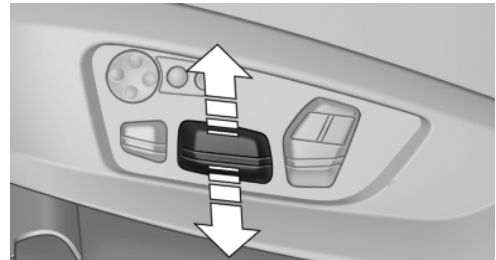

3. Seat tilt.

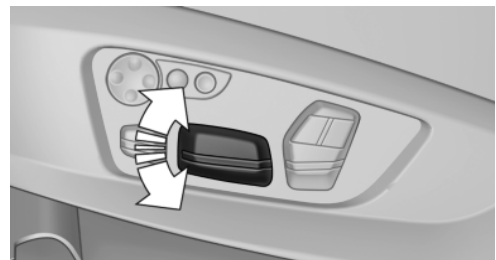

## 4. Backrest tilt.

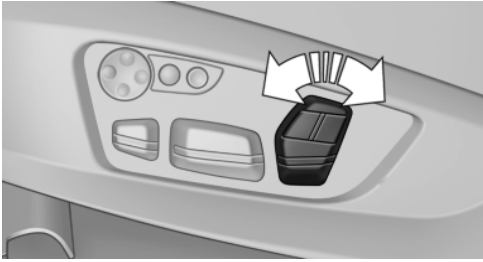

## 5. Thigh support\*.

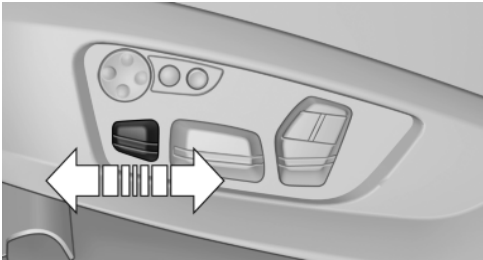

## Lumbar support\*

The curvature of the seat backrest can be adjusted in such a way that it supports the lumbar region of the spine. The lower back and the spine are supported for upright posture.

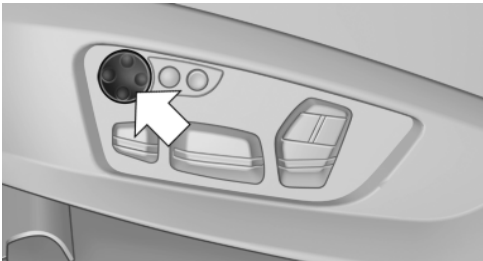

- ▷ Press the front/rear section of the switch. The curvature is increased/decreased.
- ▷ Press the upper/lower section of the switch. The curvature is shifted up/down.

## Backrest width\*

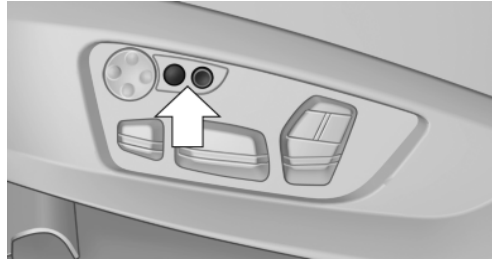

Change the width of the backrest using the side wings to adjust the lateral support.

To make it easier to enter and exit the vehicle, the backrest width temporarily opens fully.

## Shoulder support\*

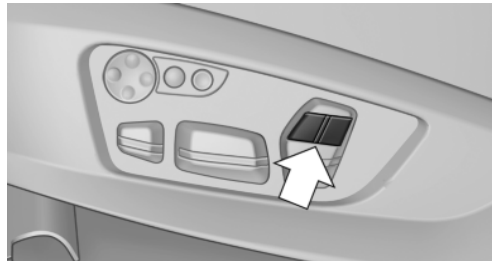

Also supports the back in the shoulder area:

- ▷ Results in a relaxed seating position.
- ▷ Reduces strain on the shoulder muscles.

## Gentleman function\*

The front passenger seat can be adjusted with the switches of the driver's seat.



1.  Press the button. The LED lights up.



- Adjust the front passenger seat on your own seat.
- If needed, store the **memory position, refer to page 56**, for the front passenger seat.
- Press the button to deactivate the function. The LED goes out.

The function deactivates itself automatically after some time.

### Active seat\*

Active adjustment of the seat cushion's contours reduces muscular tension and fatigue to help prevent lower back pain.



Press the button. The LED lights up.

### Seat heating\*



#### Switching on



Press the button once for each temperature level.

The maximum temperature is reached when three LEDs are lit.

#### Switching off

Press the button longer.

The LEDs go out.

### Temperature distribution

The heating action in the seat cushion and backrest can be distributed in different ways.

- "Climate"
- "Seat heating distribution"
- Select the required seat.

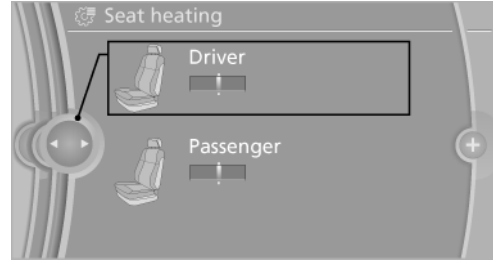

- Turn the controller to set the temperature distribution.

### Active seat ventilation\*

The seat surface is cooled by means of the integrated fan.

The ventilation rapidly cools the seat, e.g., if the vehicle interior is overheated or for continuous cooling at high temperatures.



#### Switching on



Press the button once for each ventilation level.

The highest level is active when three LEDs are lit.

After a short time, the system automatically moves down one level in order to prevent excessive cooling.

## Switching off

Press the button longer.  
The LEDs go out.

## Rear seats

### Adjusting

#### At a glance

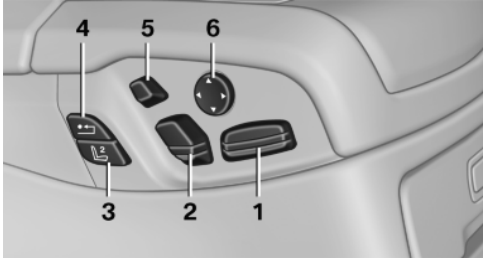

- 1 Forward/backward, tilt
- 2 Backrest
- 3 Adjust front passenger seat
- 4 Reset to the standard position
- 5 Head restraint
- 6 Lumbar support

The seats cannot be adjusted if the safety switch for the power windows has been pressed.

#### Adjustments in detail

1. Forward/back.

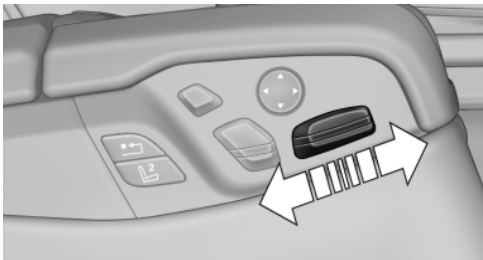

2. Seat tilt.



3. Backrest tilt.



### Lumbar support

The contour of the seat backrest can be adjusted in such a way that it supports the lumbar region of the spine. The lower back and the spine are supported for upright posture.



- ▷ Press the front/rear section of the switch.  
The curvature is increased/decreased.
- ▷ Press the upper/lower section of the switch.  
The curvature is shifted up/down.

### Adjusting the front passenger seat from the rear

For more leg room in the rear, for example.

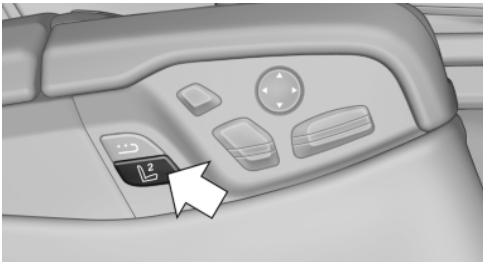

1. Press the button to activate the function, arrow.
2. Adjust the passenger seat, e.g., forward/back.
3. Press the button to deactivate the function, arrow.

The function deactivates itself automatically after some time.

### Reset\* to standard position

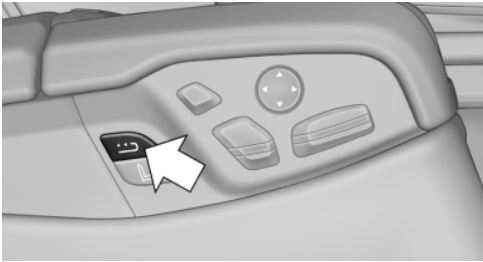

Maintain pressure on the button until the system completes the adjustment.

### Massage function in rear seats\*

Wavelike motions from the top to the bottom in the backrest relax back muscles.

### Button in rear



### Switching on



To switch on, press the button once for each massage level.

The highest level is active when two LEDs are lit.

### Switching off

To switch off, press and hold the button.

The LEDs go out.

### Seat heating\*



### Switching on



Press the button once for each temperature level.

The maximum temperature is reached when three LEDs are lit.

### Switching off

Press the button longer.

The LEDs go out.

### Temperature distribution

The heating action in the seat cushion and backrest can be distributed in different ways.

1. "Climate"
2. "Seat heating rear"

3. Select the required seat.

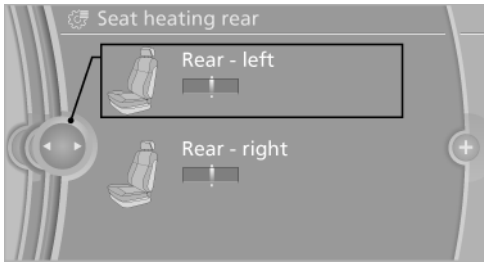

4. Turn the controller to set the temperature distribution.

## Active seat ventilation\*



### Switching on

 Press the button once for each ventilation level.

The highest level is active when three LEDs are lit.

### Switching off

Press the button longer.

The LEDs go out.

## Safety belts

### General information

Always make sure that safety belts are being worn by all occupants before driving away.

Although airbags enhance safety by providing added protection, they are not a substitute for safety belts.

### Seats with safety belt

The vehicle has four or five\* seating positions, each of which is equipped with a safety belt.

- ▷ The shoulder strap's anchorage point will be correct for adult seat occupants of every build if the seat is correctly adjusted.
- ▷ The two rear safety belt buckles, integrated into the rear seat, are for passengers sitting on the left and right.
- ▷ The belt buckle embossed with the word CENTER is intended exclusively for use by passengers riding in the center position.



One person per safety belt

Never allow more than one person to wear a single safety belt. Never allow infants or small children to ride on a passenger's lap. ◀



Putting on the belt

Lay the belt, without twisting, snugly across the lap and shoulders, as close to the body as possible. Make sure that the belt lies low around the hips in the lap area and does not press on the abdomen. Otherwise, the belt can slip over the hips in the lap area in a frontal impact and injure the abdomen.

The safety belt must not lie across the neck, rub on sharp edges, be routed over solid or breakable objects, or be pinched. ◀



Reduction of restraining effect

Avoid wearing clothing that prevents the belt from fitting properly and pull the shoulder belt periodically to readjust the tension across your lap; otherwise, the retention effect of the safety belt may be reduced. ◀

## Buckling the belt

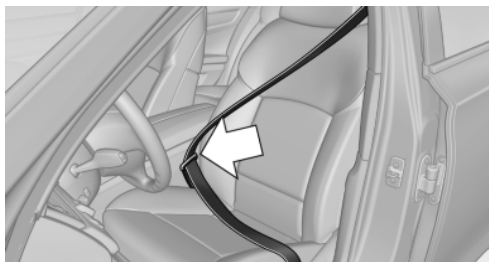

Make sure you hear the latch plate engage in the belt buckle.

After the belt is buckled and the door is closed, the belt is tightened once automatically.

## Unbuckling the belt

1. Hold the belt firmly.
2. Press the red button in the belt buckle.
3. Guide the belt back into its reel.

## Safety belt reminder for driver's and front passenger seat



The indicator lamp flashes or lights up and a signal sounds. Make sure that the safety belts are positioned correctly.

The safety belt reminder is active at speeds above approx. 5 mph/8 km/h. It can also be activated if objects are placed on the front passenger seat.

## Safety mode

In critical situations, e.g., during full brake application, the front safety belts tighten automatically.

If the situation passes without an accident occurring, the belt tension relaxes.

If the belt tension does not loosen automatically, stop the vehicle and unbuckle the belt using the red button in the buckle. Fasten the belt before continuing on your trip.

## Damage to safety belts

In the case of strain caused by accidents or damage:

Have the safety belts, including the safety belt tensioners, replaced and have the belt anchors checked.



### Checking and replacing safety belts

Have the work performed only by your authorized dealership; otherwise, it cannot be ensured that this safety feature will function properly. ◀

## Front head restraints

### Correctly adjusted head restraint

A correctly adjusted head restraint reduces the risk of injury to cervical vertebrae in the event of an accident.



### Adjusting the head restraint

Correctly adjust the head restraints of all occupied seats; otherwise, there is an increased risk of injury in an accident. ◀

### Height

Adjust the head restraint so that its center is approximately at ear level.

### Distance

Adjust the distance so that the head restraint is as close as possible to the back of the head.

### Active head restraint

In the event of a rear-end collision with a certain severity, the active head restraint automatically reduces the distance from the head.



### Reduced protective function

- ▶ Do not use seat or head restraint covers.
- ▶ Do not hang objects, e.g., clothes hangers, on the head restraints.
- ▶ Do not attach accessories to the seat or head restraint.

Otherwise, the protective function of the active head restraint will be impaired and the personal safety of the occupants will be endangered. ◀

## Adjusting the height

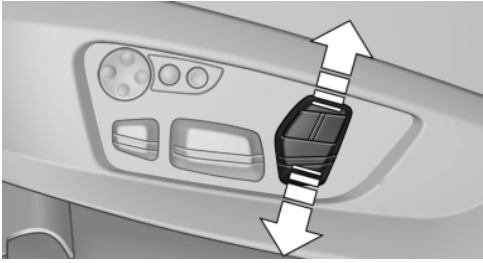

Adjusting electrically.

## Distance to the back of the head: manual head restraints

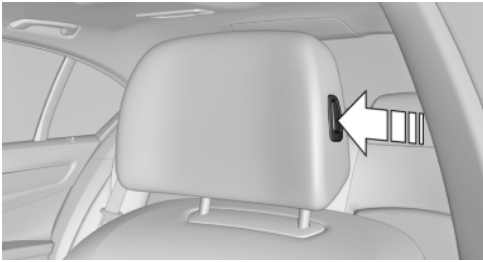

- ▷ Forward: pull.
- ▷ Back: press the button and push the head restraint toward the rear.

## Distance to the back of the head: power\* head restraints

The head restraint is automatically repositioned when the [shoulder support](#) is adjusted, refer to [page 48](#).

## Adjusting the side extensions\*

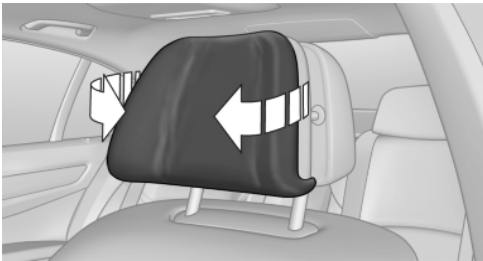

Fold forward for increased lateral support in the resting position.

## Removing

For technical reasons, the head restraints cannot be removed.

## Rear head restraints

### Correctly adjusted head restraint

A correctly adjusted head restraint reduces the risk of injury to cervical vertebrae in the event of an accident.

Adjust the head restraint so that its center is approximately at ear level.

- ⚠ Adjusting the head restraint  
Adjust the head restraint correctly; otherwise, there is an increased risk of injury in an accident. ◀

### Adjusting the height: manual head restraints

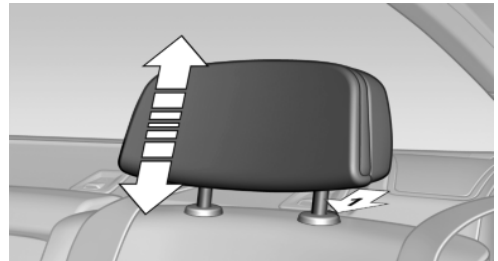

- ▷ To raise: pull.
- ▷ To lower: press the button, arrow 1, and push the head restraint down.

### Adjusting the height: electrically\*

- ▷ The head restraints on the left and right rear passenger seats extend automatically whenever a passenger in the rear seat fastens his or her safety belt.

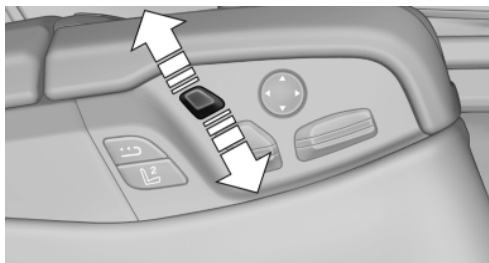

► In addition, the height of the head restraint can be adjusted electrically.



#### Extending the head restraint

To prevent possible personal injury and property damage, always ensure that the area above the head restraints is clear and unobstructed before extending them upward. ◀

The height adjustment of the head restraint is deactivated when the [safety switch for the rear windows](#), refer to [page 44](#), has been pressed.

### Adjusting the side extensions\*

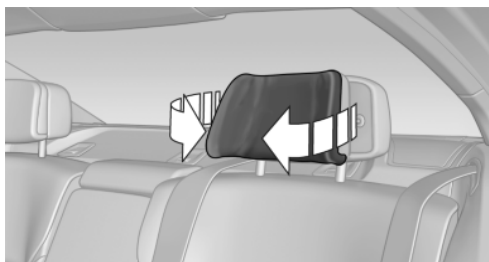

Fold the side extensions on the head restraint forward for increased lateral support in the resting position.

### Removing: manual head restraints

Only remove the head restraint if no one will be sitting in the seat in question.

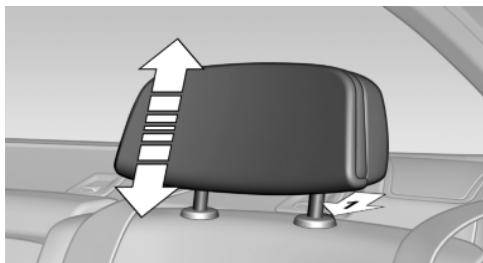

1. Pull the head restraint upward as far as possible.
2. Press the button, arrow 1, and pull the head restraint out completely.



Before transporting passengers Reinstall the head restraint before transporting anyone in the seat; otherwise, the protective function of the head restraint is unavailable. ◀

### Removing: power\* head restraints

#### Note

The rear head restraints cannot be removed. To avoid damage, they can only be reinstalled by your service center.

#### Removing

Only remove the head restraint if no one will be sitting in the seat in question.

1. Completely raise the head restraint.
2. Completely pull out the head restraint with a firm tug.



Before transporting passengers Reinstall the head restraint before transporting anyone in the seat; otherwise, the protective function of the head restraint is unavailable. ◀

## Seat, mirror, and steering wheel memory\*

### General information

#### Front



Two different driver's seat, exterior mirror, and steering wheel positions can be stored and retrieved for each remote control. The adjustment of the lumbar support is not stored.

#### Rear



Two different seat positions can be stored and retrieved.

### Storing

1. Switch on the ignition.
2. Set the desired position.
3.  Press the button on the door. The LED in the button lights up.
4. Press the desired button 1 or 2. The LED goes out.

If the M button is pressed accidentally:

-  Press the button on the door again.  
The LED goes out.

### Calling up settings

-  Do not retrieve the memory while driving  
Do not retrieve the memory setting while driving, as an unexpected movement of the seat or steering wheel could result in an accident. ◀

### Comfort function

1. Open the driver's door.
2. Switch off the ignition.
3. Briefly press the desired button 1 or 2.

The seat is automatically moved to the stored position.

The procedure stops when a switch for adjusting the seat or one of the buttons is pressed.

### Safety mode

1. Close the driver's door or switch on the ignition.
2. Press and hold the desired button 1 or 2 until the adjustment procedure is completed.

### Calling up of a seat position was deactivated

After a brief period, the calling up of stored seat positions is deactivated to save battery power.

To reactivate calling up of a seat position:

- ▷ Open or close the door or trunk lid.
- ▷ Press a button on the remote control.
- ▷ Press the Start/Stop button.

## Mirrors

### Exterior mirrors

#### General information

The mirror on the passenger side is more curved than the driver's mirror.

-  Estimating distance  
Objects reflected in the mirror are closer than they appear. Do not estimate the distance to the traffic behind you based on what you see



in the mirror, as this will increase your risk of an accident. ◀

## At a glance



- 1 Adjusting
- 2 Left/right, Automatic Curb Monitor\*
- 3 Fold in and out

## Selecting a mirror



To change over to the other mirror:  
Slide the mirror changeover switch.

## Adjusting electrically



The setting corresponds to the direction in which the button is pressed.

## Saving positions\*

Seat, mirror, and steering wheel memory, refer to page 56.

## Adjusting manually

If an electrical malfunction occurs, for example, press the edges of the mirror glass.

## Automatic Curb Monitor\*

When the reverse gear is engaged, the mirror glass tilts downward slightly on the front passenger side. This improves your view of the curb and other low-lying obstacles when parking, for example.

## Activating



1. Slide the mirror changeover switch to the driver's mirror position.

2. Engage transmission position R.

## Deactivating

Slide the mirror changeover switch to the passenger's mirror position.

## Fold in and out



Press the button.

Possible up to approx. 15 mph/20 km/h.

For example, this is advantageous

- ▶ In car washes.
- ▶ In narrow streets.
- ▶ For folding back mirrors that were folded away manually.

Mirrors that were folded in are folded out automatically at a speed of approx. 25 mph/40 km/h.



Fold in the mirror in a car wash  
Before entering an automatic car wash, fold in the exterior mirrors by hand or with the button; otherwise, they could be damaged, depending on the width of the vehicle. ◀

## Automatic heating

Both exterior mirrors are automatically heated whenever the ignition is switched on.

## Interior rearview mirror

### Reducing the blinding effect

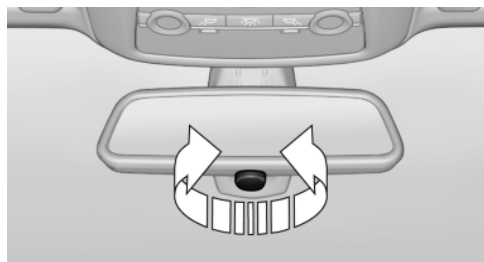

From behind when driving at night: turn the knob.

## Interior rearview mirror, automatic dimming feature\*

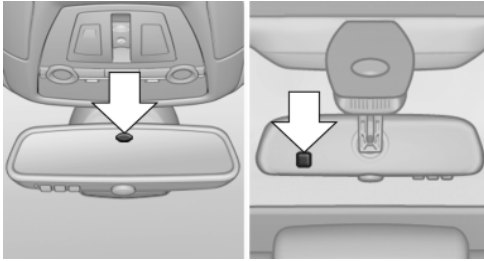

Photocells are used for control:

- ▷ In the mirror glass.
- ▷ On the back of the mirror.

For proper operation:

- ▷ Keep the photocells clean.
- ▷ Do not cover the area between the inside rearview mirror and the windshield.

## Illuminated vanity mirror\* in the rear

### Folding down

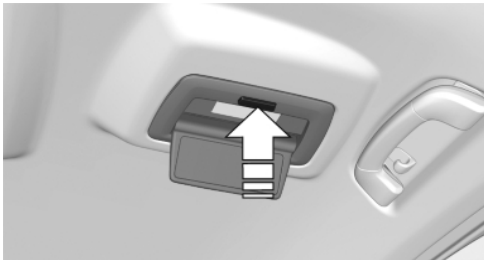

Press the button.

The vanity mirror folds down.

The angle can be adjusted by hand.

### Folding up

Press the mirror up.

## Steering wheel

### General information



Adjusting while driving

Do not adjust the steering wheel while driving; otherwise, an unexpected movement could result in an accident. ◀



### Adjusting

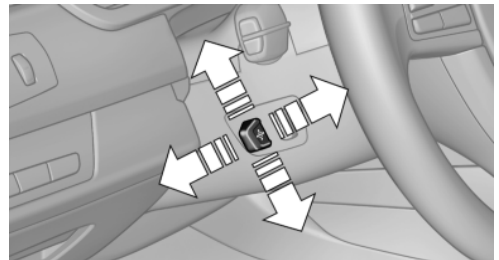

The steering wheel can be adjusted in four directions.

### Storing the position

Seat, mirror, and steering wheel memory, refer to page 56.

### Assistance getting in and out

The steering wheel temporarily moves into the highest position to make it easier to enter and exit the vehicle.

### Steering wheel heating\*

#### Switching on/off

The steering wheel heating operates with the ignition switched on.



Press the button.

- ▷ On: the LED lights up.
- ▷ Off: the LED goes out.

# Transporting children safely

## The right place for children



### Children in the vehicle

Do not leave children unattended in the vehicle; otherwise, they could endanger themselves and other persons, e.g., by opening the doors. ◀

### Children should always be in the rear

Accident research shows that the safest place for children is in the back seat.



### Transporting children in the rear

Only transport children younger than 13 years of age or shorter than 5 ft/150 cm in the rear in child restraint fixing systems provided in accordance with the age, weight and size of the child; otherwise, there is an increased risk of injury in an accident.

Children 13 years of age or older must wear a safety belt as soon as a suitable child restraint fixing system can no longer be used due to their age, weight and size. ◀

### Children on the front passenger seat

Should it ever be necessary to use a child restraint fixing system in the front passenger seat, make sure that the front, knee and side airbags on the front passenger side are deactivated. **Automatic deactivation of front passenger airbags, refer to page 91.**



### Deactivating the front passenger airbags

If a child restraint fixing system is used in the front passenger seat, the front passenger airbags must be deactivated; otherwise, there is an increased risk of injury to the child when the airbags are triggered, even with a child restraint fixing system. ◀

## Installing child restraint fixing systems

Before mounting a child restraint fixing system on the rear middle seat, return both outer backrests to the basic position.



### Manufacturer's information for child restraint fixing systems

To select, mount and use child restraint fixing systems, observe the information provided by the system manufacturer; otherwise, the protective effect can be impaired. ◀

### In the front passenger seat

After installing a child restraint fixing system in the front passenger seat, make sure that the front, knee and side airbags on the front passenger side are deactivated.



### Deactivating the front passenger airbags

If a child restraint fixing system is used in the front passenger seat, the front passenger airbags must be deactivated; otherwise, there is an increased risk of injury to the child when the airbags are triggered, even with a child restraint fixing system. ◀

### Seat position and height

Before installing a child restraint fixing system, move the front passenger seat as far back as possible and adjust its height to the middle position to obtain the best possible position for the belt and to offer optimal protection in the event of an accident.

Do not change the seat position and height after this.

### Backrest width\*

Before installing a child restraint fixing system in the front passenger seat, open the **backrest width, refer to page 48**, completely. Do not change the backrest width again and do not call up a memory position.



Backrest width for the child seat

Before installing a child restraint fixing system in the front passenger seat, the backrest width must be opened completely. Do not change the adjustment after this; otherwise, the stability of the child seat will be reduced. ◀

## Child seat security



The rear safety belts and the front passenger safety belt can be locked against pulling out for mounting the child restraint fixing systems.

## Locking the safety belt

1. Pull out the belt webbing completely.
2. Secure the child restraint fixing system with the belt.
3. Allow the belt webbing to be pulled in and pull it taut against the child restraint fixing system. The safety belt is locked.

## Unlocking the safety belt

1. Unbuckle the belt buckle.
2. Remove the child restraint fixing system.
3. Allow the belt webbing to be pulled in completely.

## LATCH child restraint fixing system

LATCH: Lower Anchors and Tether for Children.

### Note



Manufacturer's information for LATCH child restraint fixing systems

To mount and use the LATCH child restraint fixing systems, observe the operating and safety information from the system manufacturer; otherwise, the level of protection may be reduced. ◀

## Mounts for the lower LATCH anchors



Correctly engage the lower LATCH anchors

Make sure that the lower LATCH anchors have properly engaged and that the child restraint fixing system is resting snugly against the backrest; otherwise, the degree of protection offered may be reduced. ◀

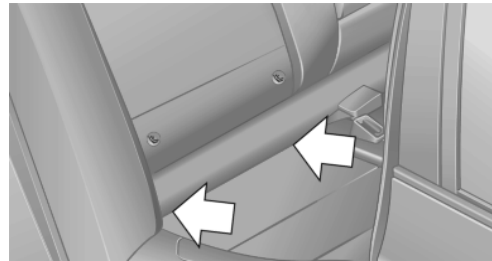

Mounts for the lower LATCH anchors are located in the gap between the seat and backrest.

Before mounting the LATCH child restraint fixing system, pull the belt away from the child restraint fixing system.

## Mounting the LATCH child restraint fixing system without power rear seats

1. Mount the child restraint fixing system; refer to the operating instructions of the system.
2. Make sure that both lower LATCH anchors have properly engaged and that the child restraint fixing system is resting snugly against the backrest.

## Mounting LATCH child restraint fixing systems on power rear seats\*

1. Before mounting, adjust the seats to their [basic position](#), refer to [page 51](#).
2. For better accessibility, tilt the backrest back slightly.

3. Mount the child restraint fixing system; refer to the operating instructions of the system.
4. Ensure that both LATCH anchors are properly connected.
5. After mounting, move the backrest back up slightly so that the child restraint fixing system rests lightly against the backrest.

## Child restraint fixing systems with a tether strap

### Mounting points

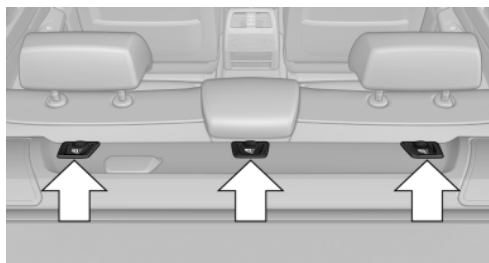

Depending on the vehicle equipment, there are two outer or three mounting points for child restraint fixing systems with a tether strap.



#### LATCH mounting eyes

Only use the mounting eyes for the upper LATCH retaining strap to secure child restraint fixing systems; otherwise, the mounting eyes could be damaged. ◀

### Retaining strap guide



#### LATCH retaining strap

Make sure that the upper LATCH retaining strap is not routed over sharp edges and is free of twisting on its way to the upper mounting point; otherwise, the belt cannot properly secure the child restraint fixing system in an accident. ◀

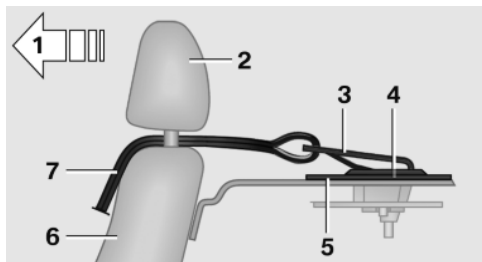

- 1 Direction of travel
- 2 Head restraint
- 3 Hook for upper retaining strap
- 4 Mounting point/eye
- 5 Rear window shelf
- 6 Seat backrest
- 7 Upper retaining strap

### Attaching the upper retaining strap to the mounting point

1. Remove the mounting point cover.
2. Raise the head restraint. Do not change the middle head restraint\*.
3. Guide the upper retaining strap between the supports of the head restraint.  
Guide it over the head restraint of the middle seat.
4. Attach the hooks of the retaining strap to the mounting eyes.
5. Pull the retaining strap taut.
6. Lower the head restraint.

# Locking the doors and windows

## Rear doors

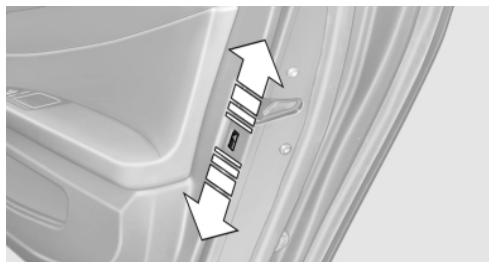

Push the locking lever on the rear doors down. The door can now be opened from the outside only.

## Safety switch for the rear



Press the button on the driver's door if children are being transported in the rear.

This locks various functions so that they cannot be operated from the rear; refer to [Safety switch](#), refer to [page 44](#).

# Driving

## Start/Stop button

### The concept



Pressing the Start/Stop button switches the ignition on or off and starts the engine.

The engine starts if the brake is depressed when you press the Start/Stop button.

### Ignition on

Press the Start/Stop button and do not depress the brake at the same time.

All vehicle systems are ready for operation.

Most of the indicator and warning lamps in the instrument cluster light up for varying lengths of time.

To save battery power when the engine is off, switch off the ignition and any unnecessary electronic systems/power consumers.

The ignition switches off automatically:

- ▶ When the vehicle is locked using the central locking system.
- ▶ Shortly before the battery is discharged completely, so that the engine can still be started.
- ▶ If the engine is switched off and the ignition is switched on, the system automatically switches to the radio ready state when the door is opened.

### Ignition off

Press the Start/Stop button again and do not depress the brake at the same time.

All indicator lamps in the instrument cluster go out.

To save battery power when the engine is off, switch off the ignition and any unnecessary electronic systems/power consumers.



Transmission position P with the ignition off

When the ignition is switched off, position P is engaged automatically. When in an automatic car wash, for example, ensure that the ignition is not switched off accidentally. ◀

When the vehicle is locked using the central locking system, the ignition switches off automatically.

### Radio ready state

This state can only be reached by pressing the Start/Stop button briefly to switch off the engine while it is running.

Some electronic systems/power consumers remain ready for operation.

Radio ready state switches off automatically:

- ▶ After approx. 8 minutes.
- ▶ When the vehicle is locked using the central locking system.

## Starting the engine

### General information



Enclosed areas

Do not let the engine run in enclosed areas; otherwise, breathing of the exhaust fumes may lead to unconsciousness and death. The exhaust gases contain carbon monoxide, an odorless and colorless but highly toxic gas. ◀



Unattended vehicle

Do not leave the car unattended with the engine running; otherwise, it presents a potential source of danger.

Before leaving the vehicle with the engine running, set the parking brake and engage transmission position P; otherwise, the vehicle may begin to roll. ◀



Frequent starting in close succession



Avoid repeated futile attempts at starting the car and avoid starting the car frequently in close succession. Otherwise, the fuel is not burned or is inadequately burned, and there is the danger of overheating and damaging the catalytic converter. ◀

Do not wait for the engine to warm up while the vehicle remains stationary. Start driving at moderate engine speeds.

## Starting the engine



Depress the brake and press the Start/Stop button.

The ignition is activated automatically for a brief period and is stopped as soon as the engine

starts.

## Engine stop

### General information



Take the remote control with you

Take the remote control with you when leaving the vehicle so that children, for example, cannot operate the windows and injure themselves. ◀



Setting the parking brake

Set the parking brake firmly when parking; otherwise, the vehicle could roll. ◀

### Switching off the engine

1. Engage transmission position P with the vehicle stopped.
2. Press the Start/Stop button.  
The engine is switched off.  
The radio ready state is switched on.
3. Set the parking brake.

### Before driving into a car wash

The vehicle is able to roll when the following steps are adhered to:

1. Depress the brake pedal.

2. Engage transmission position N.
3. Release the parking brake or deactivate [Automatic Hold](#), refer to [page 67](#).
4. Switch the engine off.



Transmission position P with the ignition off

When the ignition is switched off, position P is engaged automatically. When in an automatic car wash, for example, ensure that the ignition is not switched off accidentally. ◀

Transmission position P is engaged automatically:

- ▶ When the ignition is switched off.
- ▶ After approx. 15 minutes if the vehicle is not moved.

## Parking brake

### The concept

The parking brake is used to prevent the vehicle from rolling when it is parked.

- ▶ Engine switched off: the parking brake acts on the rear wheels.
- ▶ Engine running: the parking brake acts on the disc brakes of the front and rear wheels via the hydraulic brake system.

The parking brake can be set manually or automatically:

- ▶ Manual: by pulling and pushing the switch.
- ▶ Automatic: by activating [Automatic Hold](#), refer to [page 67](#).



## Setting



Pull the switch.

The LED lights up.



The indicator lamp lights up in red. The parking brake is set.

Indicator lamp in Canadian models



## While driving

Use while driving:

Pull the switch and hold it. The vehicle brakes hard while the button is being pulled.



The indicator lamp lights up in red, a signal sounds and the brake lamps light up.

Indicator lamp in Canadian models

If the vehicle is braked to a speed of approx. 2 mph/3 km/h, the parking brake remains set.

## Releasing



Press the switch while the brake is depressed or transmission position P is engaged.

The LED and indicator lamp go out.

The parking brake is released.



Take the remote control with you

Take the remote control with you when leaving the vehicle so that children, for example, cannot release the parking brake. ◀

## Manual release

The parking brake can be released manually in the event of a power failure or electrical fault.



Before releasing, secure the vehicle against rolling

Before releasing the parking brake manually, and whenever you park the vehicle with the parking brake released, ensure that position P of the automatic transmission is engaged.

Secure the vehicle in a manner appropriate to the inclination of the road, e.g., with a wheel chock; otherwise, there is the danger of the vehicle rolling. ◀

If it also becomes necessary to release the transmission lock of the automatic transmission manually, follow this sequence:

1. Secure the vehicle against rolling.
2. Manually release the parking brake.
3. **Manually release the transmission lock of the automatic transmission, refer to page 73.**

## Releasing

1. Remove the release tool from the tool kit.

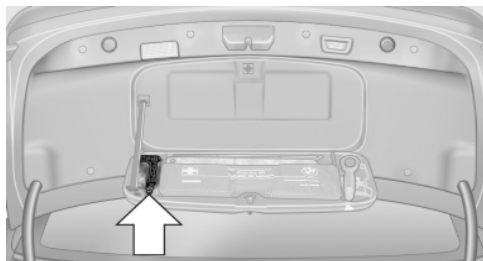

2. Raise the floor panel in the trunk.

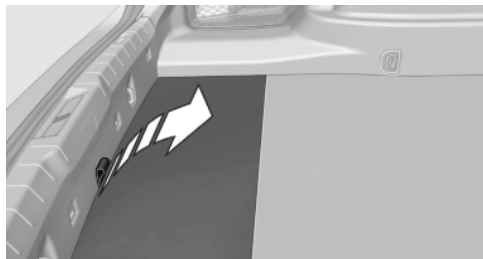

3. Take out the floor trim in the trunk, removing the screws with the release tool, arrow.



- Place the release tool on the release point, arrow.



- Forcefully pull the release tool up against the resistance until you notice a marked increase in the resistance and the parking brake releases audibly.

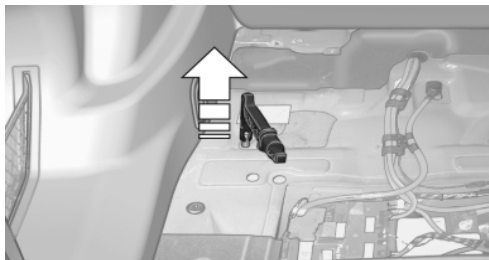

**⚠** Have the malfunction corrected  
If the parking brake has been released manually in response to a malfunction, only technicians can return it to operation.  
Have the malfunction corrected by your authorized dealership. ◀

### After a power failure

**⚠** Only put the parking brake into operation after a power failure

The parking brake should only be put into operation again if it was manually released due to an interruption in the supply of electrical power. Otherwise, it cannot be ensured that the parking brake will function properly. ◀

### Putting the parking brake into operation

- Switch on the ignition.

- P** Press the switch while the brake is depressed or transmission position P is engaged.

It may take several seconds for the brake to be put into operation. Any sounds associated with this are normal.

**PARK** The indicator lamp in the instrument cluster goes out as soon as the parking brake is ready for operation.

Indicator lamp in Canadian models

## Automatic Hold

### The concept

This system assists the driver by automatically setting and releasing the parking brake, such as when moving in stop-and-go traffic.

The vehicle is automatically held in place when it is stationary.

On inclines, the system prevents the vehicle from rolling backward when driving away.



### For your safety

Automatic Hold is deactivated automatically and the parking brake is set when:

- ▶ The engine is switched off.
- ▶ A door is opened and the driver's safety belt is unbuckled.
- ▶ The vehicle is braked to a standstill with the parking brake while driving.

**PARK**



The indicator lamp switches from green to red and the letters AUTO H go out.

Indicator lamp in Canadian models

Before driving away:

- ▷ Release the parking brake manually.
- ▷ Reactivate Automatic Hold.



Leaving the vehicle with the engine running

Before leaving the vehicle with the engine running, engage position P of the automatic transmission and ensure that the parking brake is set. Otherwise, the vehicle may begin to roll. ◀

## Activating



Press the button.

The LED and the letters AUTO H light up.



The indicator lamp lights up.  
Automatic Hold is activated.

## Deactivating



Press the button again.

The LED and the letters AUTO H go out.

Automatic Hold is deactivated.

If the vehicle is being held by Automatic Hold, press on the brake pedal to deactivate it.

When the [parking brake, refer to page 65](#), is set manually, Automatic Hold is deactivated automatically.

## Driving

Automatic Hold is activated: the vehicle is automatically secured against rolling when it stops.



The indicator lamp lights up in green.  
Depress the accelerator to drive away.



The brake is released automatically.

The indicator lamp goes out.  
Lower lamp: indicator lamp in Canadian models



Before driving into a car wash

Deactivate Automatic Hold; otherwise, the parking brake will be set when the vehicle is stationary and the vehicle will no longer be able to roll. ◀

## Parking

The parking brake is automatically set if the engine is switched off while the vehicle is being held by Automatic Hold.



The indicator lamp changes from green to red.



The parking brake is not set if the engine is switched off while the vehicle is coasting to a halt. Automatic Hold is deactivated.



The parking brake can also be released after the engine is switched off, e.g., in a car wash.



Take the remote control with you

Take the remote control with you when leaving the vehicle so that children, for example, cannot release the parking brake. ◀

## Malfunction

In the event of a failure or malfunction of the parking brake, secure the vehicle against rolling using a wheel chock, for example, when leaving it.

# Turn signal, high beams, headlamp flasher

## Turn signal

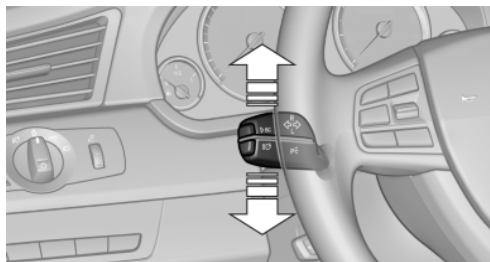

Press the lever beyond the resistance point.

To switch off manually, press the lever to the resistance point.

Unusually rapid flashing of the indicator lamp indicates that a turn signal bulb has failed.

## Triple turn signal activation

Press the lever to the resistance point.

The turn signal flashes three times.

The function can be activated or deactivated:

1. "Settings"
2. "Lighting"
3. "Triple turn signal"

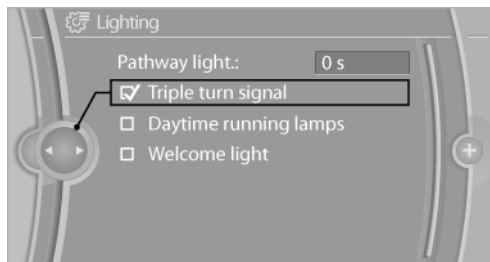

## Signaling briefly

Press the lever to the resistance point and hold it there for as long as you want the turn signal to flash.

## High beams, headlamp flasher

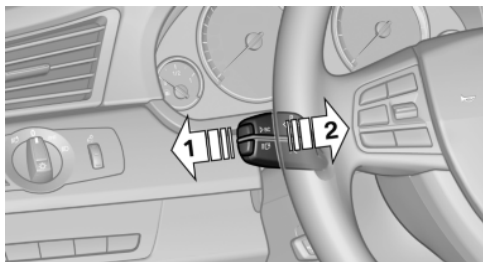

- High beams, arrow 1.
- Headlamp flasher, arrow 2.

## Washer/wiper system

### Wiper on/off and brief wipe



Do not switch on the wipers if frozen

Do not switch on the wipers if they are frozen onto the windshield; otherwise, the wiper blades and the windshield wiper motor may be damaged. ◀

### Switching on

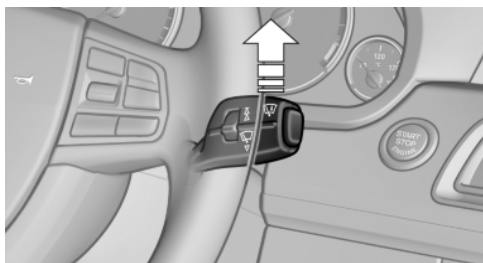

Press the wiper levers up.

The lever automatically returns to its initial position when released.

- Normal wiping speed: press up once.  
The wipers switch to intermittent operation when the vehicle is stationary.
- Fast wiping speed: press up twice or press once beyond the resistance point.  
The wipers switch to normal speed when the vehicle is stationary.

## Switching off and brief wipe

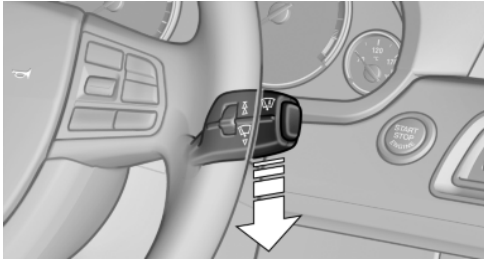

Press the wiper levers down.

The lever automatically returns to its initial position when released.

- ▷ Brief wipe: press down once.
- ▷ To switch off normal wipe: press down once.
- ▷ To switch off fast wipe: press down twice.

## Rain sensor

The time between wipes is controlled automatically and depends on the intensity of the rainfall.

The sensor is located on the windshield, directly in front of the interior rearview mirror.

## Activating/deactivating the rain sensor

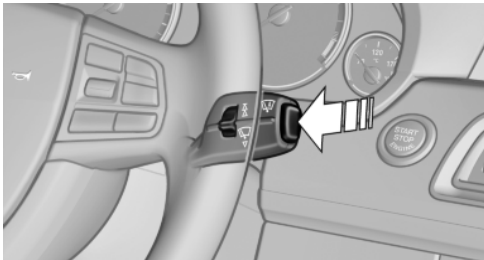

Press the button on the wiper lever.

When activated, the wipers move over the windshield once.

The LED in the steering column stalk lights up.



Deactivate the rain sensor in car washes

Deactivate the rain sensor when passing through an automatic car wash; otherwise, damage could be caused by undesired wiper activation. ◀

## Rain sensor sensitivity

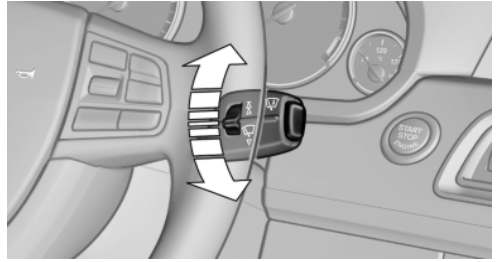

Turn the thumb wheel.

## Washing the windshield, headlamps

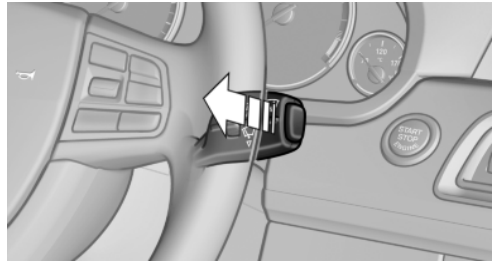

Pull the lever.

The system sprays washer fluid on the windshield and activates the wipers briefly.

In addition, the headlamps are cleaned at regular intervals when the vehicle lights are switched on.



Do not use the washer system at freezing temperatures

Do not use the washers if there is any danger that the fluid will freeze on the windshield; otherwise, your vision could be obscured. For this reason, use antifreeze.

Avoid using the washer when the reservoir is empty; otherwise, you could damage the pump. ◀

## Windshield washer nozzles

The windshield washer nozzles are automatically heated while the ignition is switched on.

## Fold-out position of the wipers

Required when changing the wiper blades or under frosty conditions, for example.

1. Switch off the ignition.
2. Under frosty conditions, ensure that the wiper blades are not frozen onto the windshield.
3. Press the wiper lever up beyond the point of resistance and hold it for approx. 3 seconds, until the wiper remains in a nearly vertical position.

After the wipers are folded back down, the [wiper system](#), refer to [page 69](#), must be reactivated.



Fold the wipers back down

Before switching the ignition on, fold the wipers back down to the windshield; otherwise, the wipers may become damaged when they are switched on. ◀

1. Switch on the ignition.
2. Press the wiper levers down. The wipers move to their resting position and are ready for operation.

## Washer fluid

### General information



Antifreeze for washer fluid

Antifreeze is flammable. Therefore, keep it away from sources of ignition.

Only keep it in the closed original container and inaccessible to children.

Follow the instructions on the container. ◀

### Container for washer fluid



Adding washer fluid

Only add washer fluid when the engine is cool and then close the cover completely to avoid contact between the washer fluid and hot engine parts.

Otherwise, there is the danger of fire and a risk to personal safety if the fluid is spilled. ◀

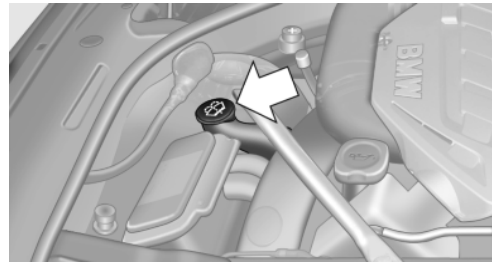

All washer nozzles are supplied from one reservoir.

Fill with water and – if required – with a washer antifreeze, according to the manufacturer's recommendations.

Mix the washer fluid before adding to maintain the correct mixing ratio.

### Capacity

Approx. 5.3 US quarts/ 5 liters

## Automatic transmission with Steptronic

### Transmission positions

#### D Drive, automatic position

Position for normal vehicle operation. All forward gears are available.

#### R is Reverse

Select only when the vehicle is stationary.

#### N is Neutral

Use in automatic car washes, for example. The vehicle can roll.

When the [ignition is switched off](#), refer to [page 64](#), position P is engaged automatically.

#### P Park

Select only when the vehicle is stationary. The drive wheels are blocked.

P is engaged automatically:

- ▷ After the engine is switched off, if the car is in [radio ready state](#), refer to [page 64](#), or if the

ignition is switched off, refer to page 64, and if position R or D is engaged.

- ▷ If the ignition is switched off and position N is engaged.
- ▷ If the vehicle is standing with position R or D engaged and you unfasten the belt of the driver's seat and open the driver's door.

## Kick-down

Kick-down is used to achieve maximum driving performance. Depress the accelerator beyond the resistance point at the full throttle position.

## Engaging the transmission position

- ▷ Transmission position P can only be disengaged if the engine is running and the brake is depressed.
- ▷ With the vehicle stationary, depress the brake pedal before shifting out of P or N; otherwise, the shift command will not be executed: shift lock.

 Depress the brake until you start driving

To prevent the vehicle from creeping after you select a driving position, maintain pressure on the brake pedal until you are ready to start. ◀

## Engaging D, R and N



Briefly push the selector lever in the desired direction, beyond a resistance point if necessary. After releasing the selector lever, it returns to its center position.

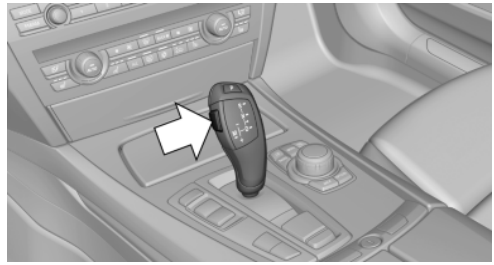

Press the Unlock button to:

- ▷ Engage R.
- ▷ Shift out of P.

## Engaging P



Press button P.

## Sport program and manual mode M/S

### Activating the sport program



Push the selector lever to the left out of transmission position D.

DS is displayed in the instrument cluster.

This position is recommended for a performance-oriented driving style.



## Activating the M/S manual mode

Push the selector lever to the left out of transmission position D.

Push the selector lever forward or backward.

Manual mode becomes active and the gear is changed.

The engaged gear is displayed in the instrument cluster, e.g., M1.

- ▶ To shift down: press the selector lever forward.
- ▶ To shift up: press the selector lever backward.

The transmission only shifts up or down if the rpm and vehicle speed are appropriate. If the engine speed is too high, the transmission does not shift down.

The selected gear is briefly displayed in the instrument panel, followed by the current gear.

## Ending the sport program/manual mode

Push the selector lever to the right.

D is displayed in the instrument cluster.

## Displays in the instrument cluster

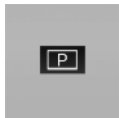

The gear position is displayed, e.g., P.

## Manually releasing and engaging the transmission lock

In the event of a power failure, manually release the transmission lock; otherwise, the drive wheels will be locked and it will not be possible to tow the vehicle.

 Depress the brake when releasing the transmission lock

When manually releasing the transmission lock, depress the brake; otherwise, the vehicle could roll. ◀

Only release the transmission lock in the event of a malfunction, e.g., for towing.

After parking the vehicle, engage the transmission lock again.

If the parking brake needs to be manually released as well, adhere to the following sequence:

1. Secure the vehicle against rolling.
2. [Manually release the parking brake, refer to page 66.](#)
3. Manually release the transmission lock.

## Releasing

1. Open the cover of the cup holder.

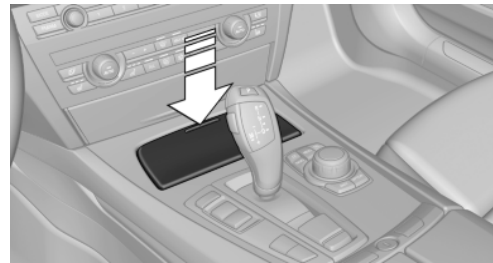

2. Tip the cup holder insert to the rear and remove it.



3. Take out the mat of the cup holder.

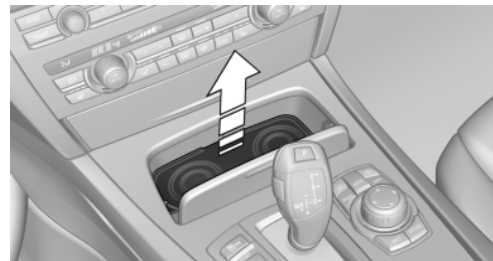

4. Snap out the cover using the screw driver from the tool kit.

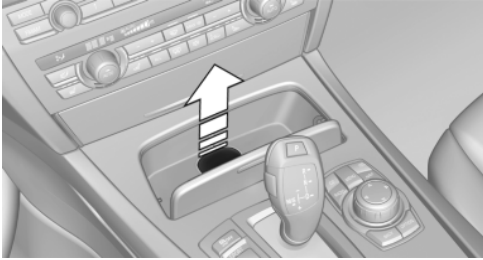

5. Remove the release tool from the tool kit.



6. Insert the release tool into the opening.

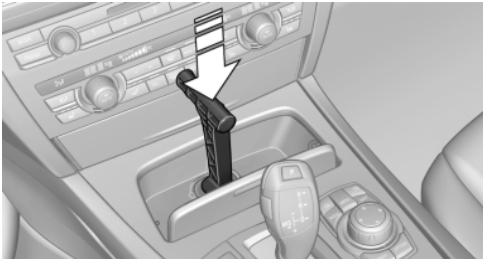

7. Turn the release tool all the way and then press down. The transmission lock is released and position P is no longer engaged.



### Locking the transmission lock again

After parking the vehicle, lock the transmission lock again to prevent the vehicle from rolling. ◀

### Locking

Pull out the release tool. The transmission lock is locked again.

# Displays

## Instrument cluster

### At a glance

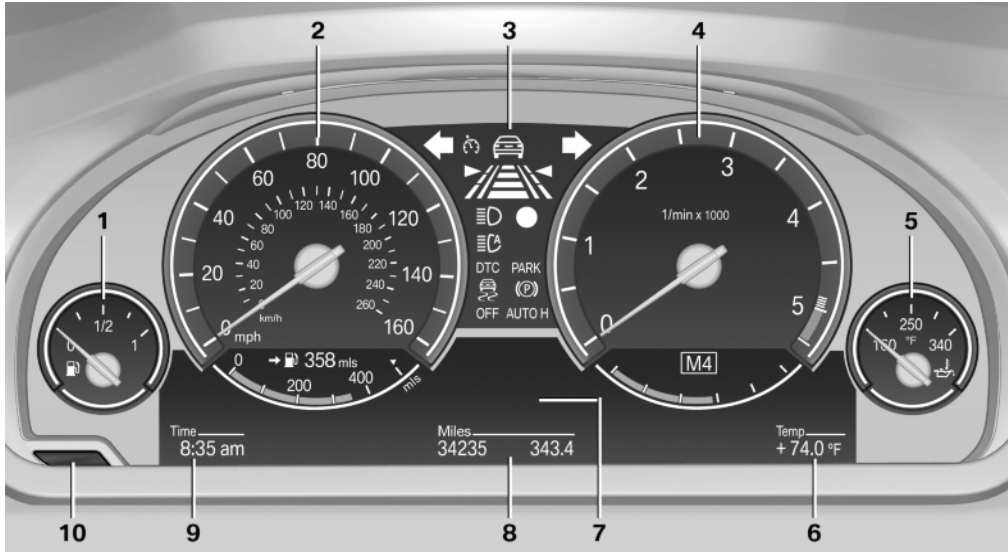

- 1 Fuel gauge
- 2 Speedometer
- 3 Indicator/warning lamps
- 4 Tachometer
- 5 Oil temperature
- 6 External temperature
- 7 Electronic displays
- 8 Miles, trip miles
- 9 Clock
- 10 Display/reset miles

### Odometer and trip odometer

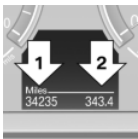

- ▷ Odometer, arrow 1.
- ▷ Trip odometer, arrow 2.



Press the knob.

- ▷ When the ignition is switched off, the time, external temperature and odometer are displayed.
- ▷ When the ignition is switched on, the trip odometer is reset.

### External temperature

#### External temperature warning

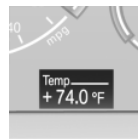

When the display drops to  $+37^{\circ}\text{F}/+3^{\circ}\text{C}$ , a signal sounds and a message appears in the instrument cluster.

There is the increased danger of ice.



Ice on roads

Even at temperatures above  $+37^{\circ}\text{F}/+3^{\circ}\text{C}$ , there can be a risk of ice on roads.

Therefore, drive carefully on bridges and shady roads, for example, to avoid the increased danger of an accident. ◀

## Time

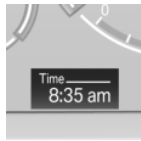

The time is displayed at the bottom of the instrument cluster.

Setting the time and time format, refer to page 80.

## Date

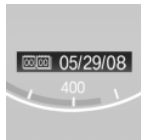

The date is displayed in the speedometer.

Setting the date and date format, refer to page 81.

## Tachometer



Always avoid engine speeds in the red warning field. In this range, the fuel supply is interrupted to protect the engine.

## Coolant temperature

Should the coolant, and with it the engine, become too hot, a warning message is displayed.

Check the coolant level, refer to page 236.

## Engine oil temperature



- ▷ Cold engine: the pointer is at the low temperature end. Drive at moderate engine and vehicle speeds.
- ▷ Normal operating temperature: the pointer is in the middle or in the right half of the temperature display.
- ▷ Hot engine: the pointer is at the high temperature end. Switch off the engine immediately and allow it to cool down.

Check the oil level, refer to page 235.

## Current fuel consumption



Displays the current fuel consumption. You can check whether you are currently driving in an efficient and environmentally-friendly manner.

## Displaying the current fuel consumption

1. "Settings"
2. "Info display"
3. "Range/consumption"

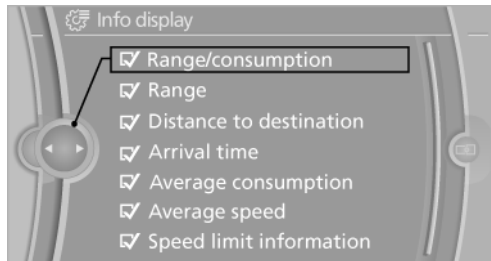

The bar display for the current fuel consumption is displayed in the instrument cluster.

## Energy recovery



The kinetic energy of the vehicle is converted to electrical energy **while coasting, refer to page 150**. The vehicle battery is partially charged and fuel consumption can be lowered.

## Fuel gauge



Gasoline engine:

Fuel tank capacity: approx. 21.6 US gal/82 liters

The vehicle inclination may cause the display to vary.

Notes on refueling, refer to page 224.

## Range



After the reserve range is reached:

- ▶ A message appears briefly.
- ▶ The remaining range is shown on the computer.

The message appears continuously below a range of approx. 30 miles/50 km.



Refuel below 30 miles/50 km

Refuel below a range of 30 miles/50 km; otherwise, engine functions are not ensured and damage may occur. ◀

## Displaying the cruising range

1. "Settings"
2. "Info display"

### 3. "Range/consumption"

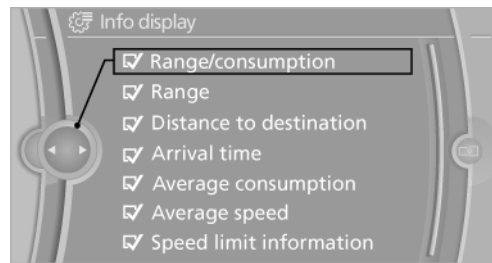

The bar display for the cruising range is displayed in the instrument cluster.

## Selection lists in the instrument cluster

### The concept



The following functions can be operated using the buttons and the thumb wheel on the steering wheel and the display in the instrument cluster:

- ▶ Current audio source.
- ▶ Activation of the voice activation system\*.

## Activating a list and creating the setting

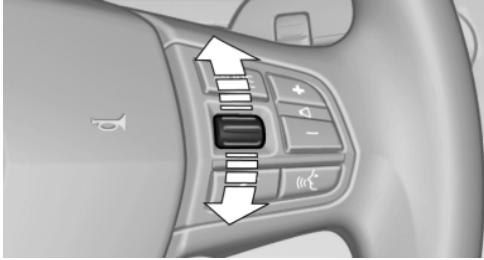

Press a button on the right side of the steering wheel or turn the thumb wheel to activate the required list.

Create the setting using the thumb wheel.

After entering the distance or when destination guidance is activated in the navigation system.

- ▷ Time of arrival\*

After entering the distance or when destination guidance is activated in the navigation system.

- ▷ Date\*.
- ▷ Arrow view of navigation system\*.

## Adjusting the info display

You can select what information from the computer is to be displayed on the info display of the instrument cluster.

1. "Settings"
2. "Info display"
3. Select the desired displays.

## Computer

### Calling up information on the info display

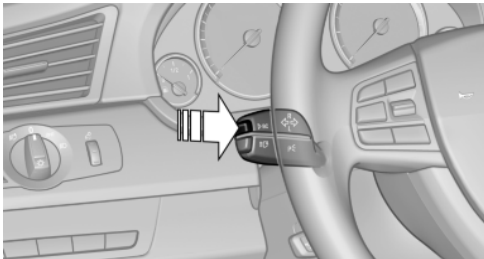

Press the computer button on the turn signal lever.

Information is displayed on the info display of the instrument cluster.

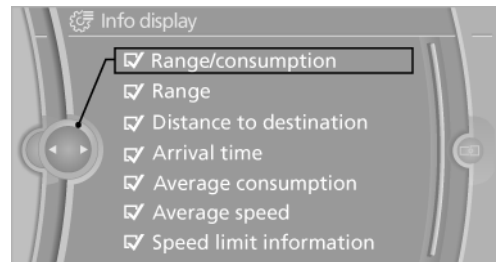

## Information in detail

### Range

Displays the estimated cruising range available with the remaining fuel.

It is calculated based on your driving style over the last 20 miles/30 km. If there is only enough fuel left for less than 45 miles/80 km, the color of the display changes.

### Average fuel consumption

This is calculated for the period during which the engine is running.

### Average speed

Periods in which the vehicle is parked with the engine stopped do not enter into the calculation.

## Information at a glance

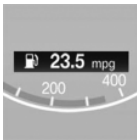

Repeatedly pressing the button on the turn signal lever displays the information on the info display in the following order:

- ▷ Range.
- ▷ Average fuel consumption.
- ▷ Average speed.
- ▷ Distance to destination\*

## Resetting average values

Press and hold the button on the turn signal lever.

## Distance to destination

The remaining distance to the destination is displayed if one of the following measures was taken before starting the trip:

- ▷ A distance was entered in the computer.
- ▷ A destination was entered in the navigation system\*.

The distance to the destination on the planned route of the navigation system is adopted automatically.

The distance entered in the computer is overwritten after approx. 1,640 ft/500 m.

## Manually setting the distance to the destination

1. "Vehicle Info"
2. "Onboard info"
3. "To dest."

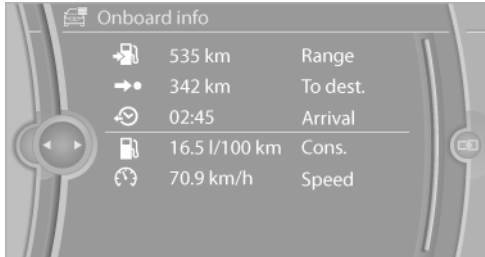

4. Turn the controller until the desired distance is displayed.
5. Press the controller.

## Time of arrival

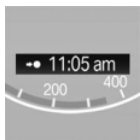

The estimated time of arrival is displayed if the following information was entered before starting the trip:

- ▷ A distance in the computer.
- ▷ A destination in the navigation system\*.

The time must be correctly set.

## Speed limit

Display of a speed limit which, when reached, should cause a warning to be issued.

Renewed warning if the vehicle speed drops below the set speed limit once by at least 3 mph/ 5 km/h.

## Displaying, setting or changing the limit

1. "Settings"
2. "Speed"
3. "Warning at:"

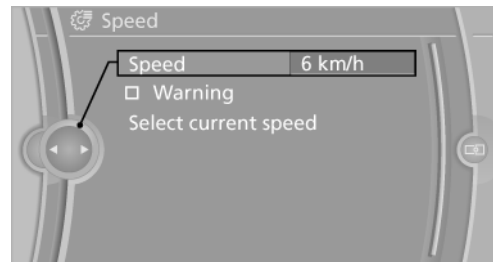

4. Turn the controller until the desired limit is displayed.
  5. Press the controller.
- The speed limit is stored.

## Activating/deactivating the limit

1. "Settings"
2. "Speed"
3. "Warning"
4. Press the controller.

## Applying your current speed as the limit

1. "Settings"
2. "Speed"
3. "Select current speed"
4. Press the controller.

The current vehicle speed is stored as the limit.

## Resetting values

The average fuel consumption and average speed can be reset.

Press and hold the computer button on the turn signal lever.

## Trip computer

There are two types of computer.

- ▷ "Onboard info": the values can be reset as often as necessary.
- ▷ "Trip computer": the values provide an overview of the current trip.

## Resetting the trip computer

1. "Vehicle Info"
2. "Trip computer"

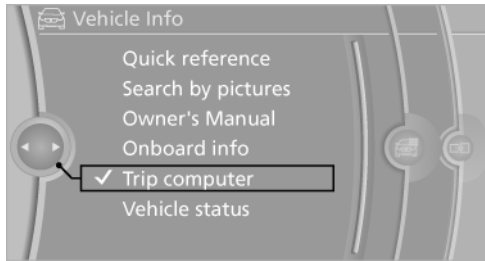

3. "Reset" All values are reset.  
"Automatically reset" all values are reset approx. 4 hours after the vehicle comes to a standstill.

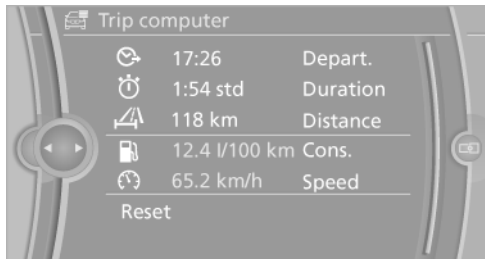

## Display on the Control Display

Display the computer or trip computer on the Control Display.

1. "Vehicle Info"
2. "Onboard info" or "Trip computer"

## Resetting the fuel consumption and speed

1. "Vehicle Info"
2. "Onboard info"
3. "Cons." or "Speed"

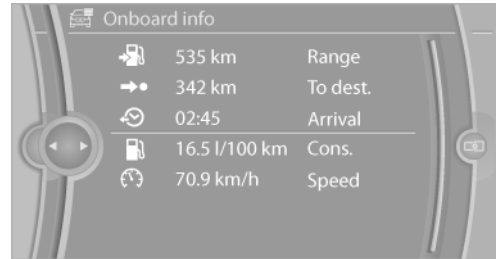

4. "Yes"

## Settings on the Control Display

### Time

#### Setting the time

1. "Settings"
2. "Time/Date"



3. "Time:"

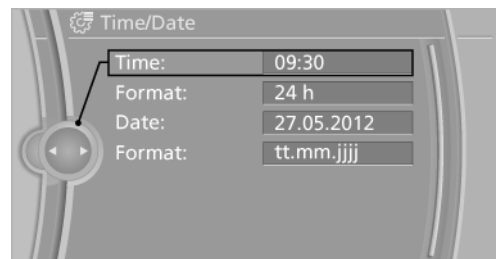



- Turn the controller until the desired hours are displayed.
  - Press the controller.
  - Turn the controller until the desired minutes are displayed.
  - Press the controller.
- The time is stored.

### Setting the time format

- "Settings"
- "Time/Date"
- "Format:"
- Select the desired format.

The time format is stored.

## Date

### Setting the date

- "Settings"
- "Time/Date"
- "Date:"
- Turn the controller until the desired day is displayed.
- Press the controller.
- Make the necessary settings for the month and year.

The date is stored.

### Setting the date format

- "Settings"
- "Time/Date"
- "Format:"
- Select the desired format.



The date format is stored.

## Language

### Setting the language

To set the language on the Control Display:

- "Settings"
- "Language/Units"



- "Language:"

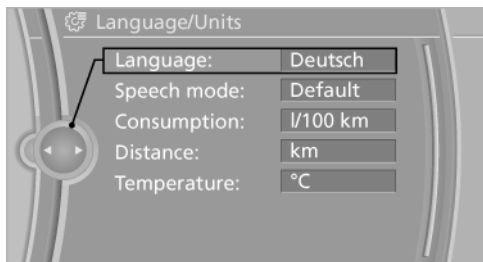

- Select the desired language.

The setting is stored for the remote control currently in use.

### Setting the voice dialog

To switch between a standard dialog and a short dialog.

- "Settings"
- "Language/Units"
- "Speech mode:"

4. Select the desired dialog.

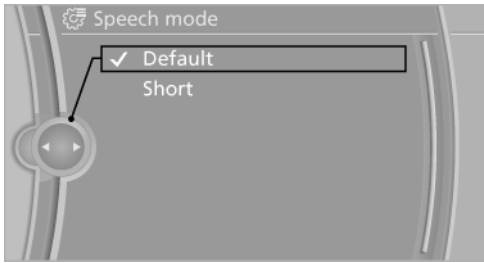

## Units of measure

### Setting the units of measure

To set the units for fuel consumption, route/distance and temperature:

1. "Settings"
2. "Language/Units"
3. Select the desired menu item.

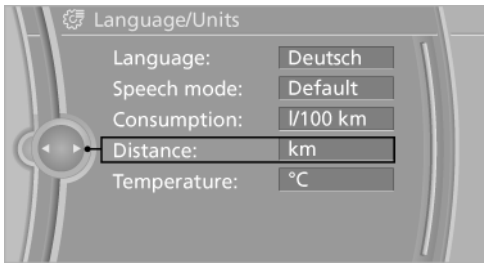

4. Select the desired unit.

The setting is stored for the remote control currently in use.

## Brightness

### Setting the brightness

To set the brightness of the Control Display:

1. "Settings"
2. "Control display"

3. "Brightness"

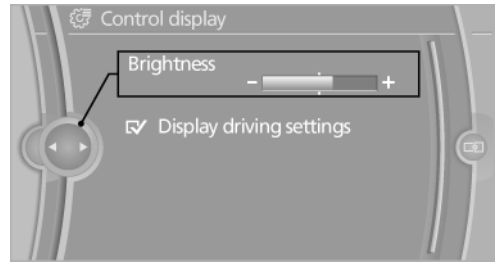

4. Turn the controller until the desired brightness is set.
5. Press the controller.

The setting is stored for the remote control currently in use.

Depending on the light conditions, the brightness control may not be clearly visible.

## Service requirements

### Display

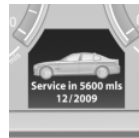

The driving distance or the time to the next service is displayed briefly after the ignition is switched on.

The current service requirements can be read out from the remote control by the service consultant.

Data regarding the maintenance status or legally mandated inspections of the vehicle are automatically transmitted to your service center before a service due date, [Automatic Service Request](#), refer to page 217.

### Detailed information on service requirements

More information on the scope of service required can be displayed on the Control Display.

1. "Vehicle Info"

## 2. "Vehicle status"

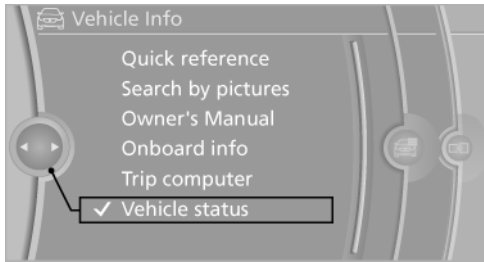

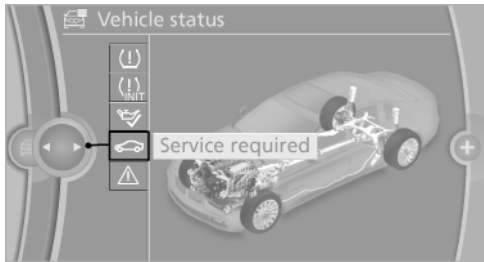

## 3. "Service required"

Required maintenance procedures and legally mandated inspections are displayed.



4. Select an entry to call up detailed information.

## Symbols

Symbols	Description
	No service is currently required.
	The deadline for service or a legally mandated inspection is approaching. Please make a service appointment.
	The service deadline has already passed.

## Entering appointment dates

Enter the dates for the required inspections. Ensure that the vehicle date and time are set correctly.

1. "Vehicle Info"

2. "Vehicle status"

3. "Service required"

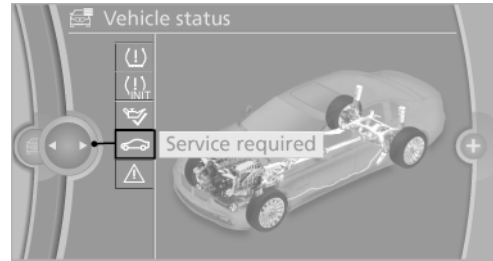

4. "§ Vehicle inspection"

5. "Date:"

6. Create the settings.

7. Confirm.

The entered date is stored.

## Automatic Service Request

Data regarding the maintenance status or legally mandated inspections of the vehicle are automatically transmitted to your service center before a service due date.

You can check when your service center was notified.

1. "Vehicle Info"
2. "Vehicle status"
3. Open "Options".
4. "Last Service Request"

## Check Control

### The concept

The Check Control system monitors functions in the vehicle and notifies you of malfunctions in the monitored systems.

A Check Control message is displayed as a combination of indicator or warning lamps and text messages in the instrument cluster and in the Head-up Display\*.

In addition, an acoustic signal may be output and a text message may appear on the Control Display.

## Indicator/warning lamps



The indicator and warning lamps can light up in a variety of combinations and colors.

Several of the lamps are checked for proper functioning and light up temporarily when the engine is started or the ignition is switched on.

## Text messages

Text messages in combination with a symbol in the instrument cluster explain a Check Control message and the meaning of the indicator and warning lamps.

## Supplementary text messages

Additional information on the Control Display, e.g., on the cause of a malfunction or the required action, can be called up via Check Control.

The text of urgent messages is displayed automatically.

## Hiding Check Control messages

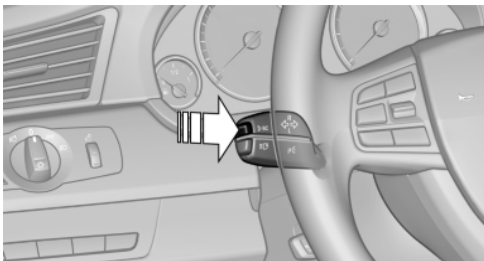

Press the computer button on the turn signal lever.

- ▶ Some Check Control messages can be hidden for approx. 8 seconds.

They continue to exist until the malfunction has been eliminated.

If several malfunctions occur at once, the messages are displayed consecutively.

- ▶ Other Check Control messages are hidden automatically after approx. 23 seconds. They are stored and can be displayed again later.

## Displaying stored Check Control messages

1. "Vehicle Info"
2. "Vehicle status"
3. "Check Control"

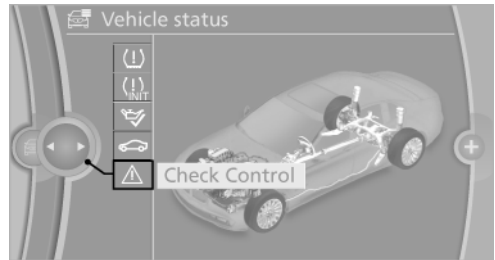

4. Select the text message.

## Messages after trip completion

Malfunctions indicated during a trip are displayed again after the ignition is switched off.

# Lamps

## At a glance

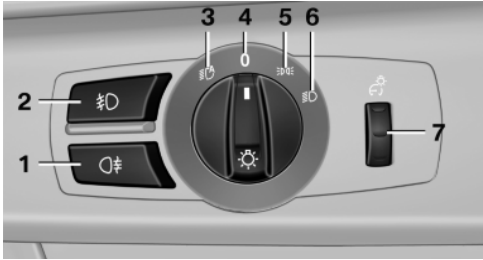

- 1 Rear fog lamps\*
- 2 Front fog lamps
- 3 Automatic headlamp control/adaptive light control\*/high-beam assistant\*/welcome lamps
- 4 Lamps off/daytime running lights\*
- 5 Parking lamps
- 6 Low beams/welcome lamps
- 7 Instrument lighting

## Parking lamps/low beams, headlamp control

### Parking lamps

Switch position : the vehicle lamps light up on all sides, e.g., for parking.

Do not use the parking lamps for extended periods; otherwise, the battery may become discharged and it would then be impossible to start the engine.

When parking, it is preferable to switch on the one-sided [roadside parking lamps](#), refer to [page 86](#).

### Low beams

Switch position with the ignition switched on: the low beams light up.

## Welcome lamps

When parking the vehicle, leave the switch in position or : the parking and interior lamps light up briefly when the vehicle is unlocked.

## Activating/deactivating the welcome lamps

1. "Settings"
2. "Lighting"
3. "Welcome light"



The setting is stored for the remote control currently in use.

## Headlamp courtesy delay feature

The low beams stay lit for a short while after the ignition is switched off, if the lamps are switched off and the headlamp flasher is switched on.

## Setting the duration

1. "Settings"
2. "Lighting"
3. "Pathway light.: s"

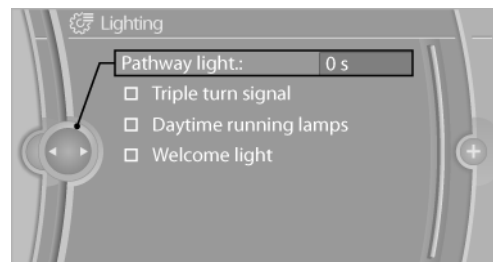

#### 4. Set the duration.

The setting is stored for the remote control currently in use.

### Automatic headlamp control

Switch position : the low beams are switched on and off automatically, e.g., in tunnels, in twilight or if there is precipitation. The indicator lamp in the instrument cluster lights up.

A blue sky with the sun low on the horizon can cause the lights to be switched on.

The low beams always stay on when the fog lamps are switched on.





Personal responsibility

The automatic headlamp control cannot serve as a substitute for your personal judgment in determining when the lamps should be switched on in response to ambient lighting conditions.

For example, the sensors are unable to detect fog or hazy weather. To avoid safety risks, you should always switch on the lamps manually under these conditions. ◀

### Daytime running lights\*

The daytime running lights light up in position 0,  and . After the ignition is switched off, the parking lamps light up in position .

### Activating/deactivating

1. "Settings"
2. "Lighting"
3. "Daytime running lamps"

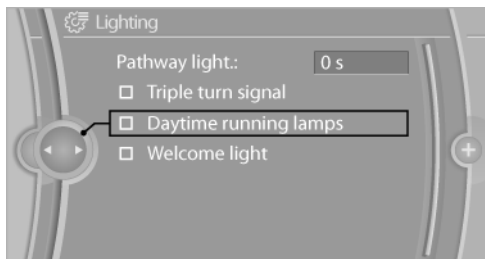

The setting is stored for the remote control currently in use.

### Roadside parking lamps

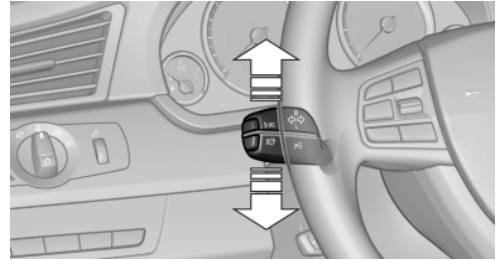

The vehicle can be illuminated on one side.

### Switching on

With the ignition switched off, press the lever either up or down past the resistance point for approx. 2 seconds.

### Switching off

Briefly press the lever to the resistance point in the opposite direction.

## Adaptive light control\*

### The concept

Adaptive light control is a variable headlamp control system that enables dynamic illumination of the road surface.

Depending on the steering angle and other parameters, the light from the headlamp follows the course of the road.

In tight curves, such as on mountainous roads or when turning, turning lamps that light up the inside area of the curve are switched on at speeds up to approx. 70 km/h, approx. 44 mph.

### Controls

#### Activating

Switch position  with the ignition switched on.

The turning lamps are automatically switched on depending on the steering angle or the use of turn signals.

To avoid blinding oncoming traffic, the adaptive light control directs light towards the front passenger side when the vehicle is at a standstill.

When driving in reverse, only the turning lamp is active and illuminates the outside of the curve.

## Self-leveling headlights

The self-leveling headlights feature adapts the light distribution to the contours of the road.

The light distribution is lowered on hilltops to avoid blinding oncoming traffic and raised in depressions to increase visibility.

## Malfunction

A message is displayed.

Adaptive light control is malfunctioning or has failed. Have the system checked as soon as possible.



## High-beam assistant\*

### The concept

When the lights are switched on, this system automatically switches the high beams on and off. The procedure is controlled by a sensor on the front of the interior rearview mirror. The assistant ensures that the high beams are switched on whenever the traffic situation allows. The driver can intervene at any time and switch the high beams on and off as usual.

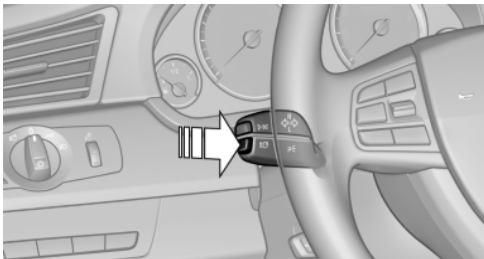
### Activating the high-beam assistant



1. Turn the light switch to position  or .
2. Press the button on the turn signal lever, arrow.



The indicator lamp in the instrument cluster lights up.

When the lights are switched on, the high beams are switched on and off automatically.

The system responds to light from oncoming traffic and traffic driving ahead of you, and to adequate illumination, e.g., in towns and cities.

### Switching the high beams on and off manually

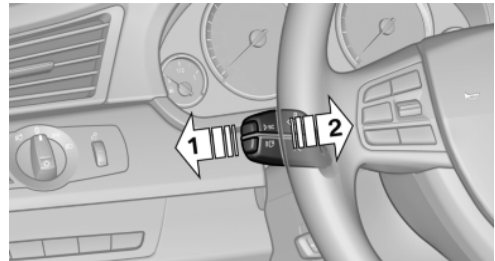

- ▷ High beams on, arrow 1.
  - ▷ High beams off/headlamp flasher, arrow 2.
- To reactivate the high-beam assistant, press the button on the turn signal lever.

### System limits



Personal responsibility

The high-beam assistant cannot serve as a substitute for the driver's personal judgment of when to use the high beams. Therefore, manually switch off the high beams in situations where this is required to avoid a safety risk. ◀

The system is not fully functional in situations such as the following, and driver intervention may be necessary:

- ▷ In very unfavorable weather conditions, such as fog or heavy precipitation.
- ▷ In detecting poorly-lit road users, such as pedestrians, cyclists, horseback riders and

wagons; when driving close to train or ship traffic; and at animal crossings.

- ▷ In tight curves, on hilltops or in depressions, in cross traffic or half-observed oncoming traffic on freeways.
- ▷ In poorly-lit towns and cities and in the presence of highly reflective signs.
- ▷ At low speeds.
- ▷ When the windshield in front of the interior rearview mirror is fogged over, dirty or covered with stickers, etc.
- ▷ If the sensor view field is dirty.

## Sensor view field

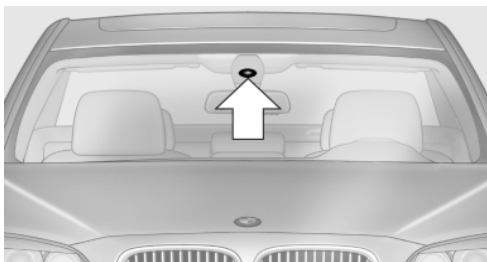

The view field of the sensor is located on the front of the interior rearview mirror.

Do not cover this area with stickers, etc.

Clean the view field, refer to page 252.

## Fog lamps

### Front fog lamps

The parking lamps or low beams must be switched on.

 Press the button. The green indicator lamp lights up.

If the [automatic headlamp control](#), refer to [page 86](#), is activated, the low beams will come on automatically when you switch on the front fog lamps.

## Cornering lamp\*

In the  switch position, a cornering lamp is switched on for a broader light distribution at speeds up to 68 mph/110 km/h.

## Instrument lighting

### Adjusting



The parking lamps or low beams must be switched on to adjust the brightness.

Adjust the brightness using the thumb wheel.

## Interior lamps

### General information

The interior lamps, footwell lamps, entry lamps and courtesy lamps are controlled automatically.

The brightness of some of these lamps is influenced by the thumb wheel for the instrument lighting.

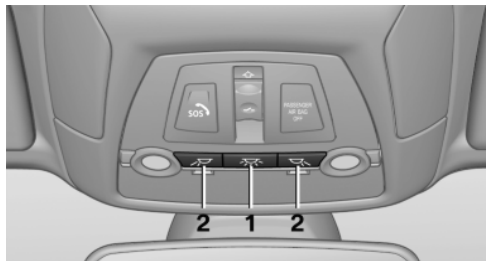

- 1 Interior lamps
- 2 Reading lamp

### Switching the interior lamps on and off



Press the button.

To switch off permanently: press the button for approx. 3 seconds.

To clear this setting: briefly press the button.



## Reading lamps



Press the button.

Reading lamps are located at the front and rear next to the interior lamps.

## Safety

### Airbags

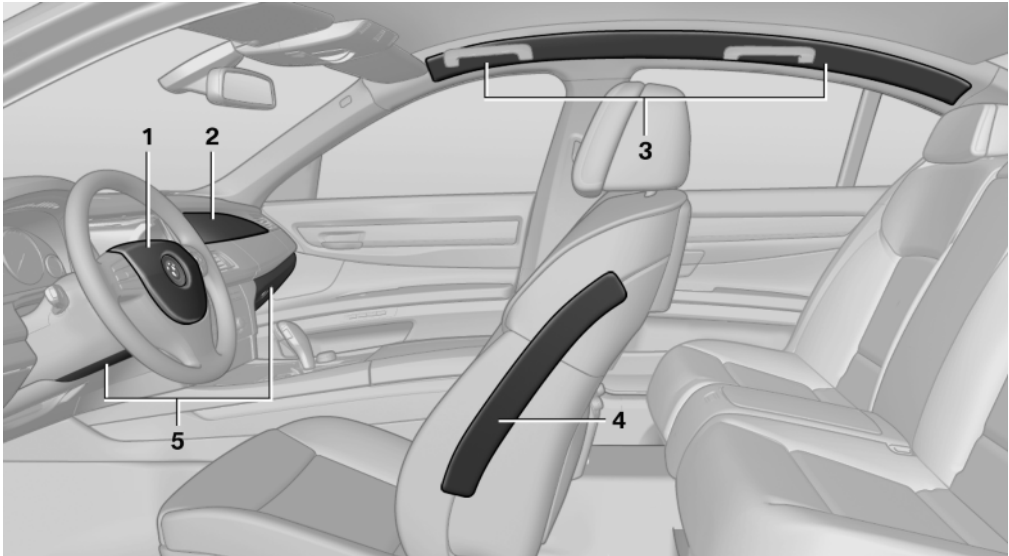

- 1 Front airbag, driver
- 2 Front airbag, front passenger
- 3 Head airbags
- 4 Side airbag
- 5 Knee airbags

#### Front airbags

Front airbags help protect the driver and front passenger by responding to frontal impacts in which safety belts alone cannot provide adequate restraint.

#### Side airbags

In a lateral impact, the side airbag supports the body on the side in the chest area.

#### Head airbags

In a lateral impact, the head airbag supports the head.

#### Knee airbag

The knee airbag protects the legs during a frontal collision.

#### Protective action

Airbags are not triggered in every impact situation, e.g., in less severe accidents or rear-end collisions.

Even when all instructions are followed closely, injury from contact with the airbags cannot be ruled out in certain situations.

The ignition and inflation noise may lead to short-term and, in most cases, temporary hearing impairment in sensitive individuals.

 Information on how to ensure the optimal protective effect of the airbags

- ▷ Keep at a distance from the airbags.
- ▷ Always grasp the steering wheel on the steering wheel rim, holding your hands at the 3 o'clock and 9 o'clock positions, to keep

the danger of injury to your hands or arms as low as possible if the airbag is triggered.

- ▷ There should be no people, animals, or objects between an airbag and a person.
- ▷ Do not use the cover of the front airbag on the front passenger side as a storage area.
- ▷ Keep the dashboard and window on the front passenger side clear, i.e., do not cover with adhesive labels or coverings, and do not attach holders such as for navigation instruments and mobile phones.
- ▷ Make sure that the front passenger is sitting correctly, i.e., keeps his or her feet and legs in the footwell; otherwise, leg injuries can occur if the front airbag is triggered.
- ▷ Do not place slip covers, seat cushions or other objects on the front passenger seat that are not approved specifically for seats with integrated side airbags.
- ▷ Do not hang pieces of clothing, such as jackets, over the backrests.
- ▷ Make sure that occupants keep their head away from the side airbag and do not rest against the head airbag; otherwise, injuries can occur if the airbags are triggered.
- ▷ Do not remove the airbag restraint system.
- ▷ Do not remove the steering wheel.
- ▷ Do not apply adhesive materials to the airbag cover panels, cover them or modify them in any way.
- ▷ Never modify either the individual components or the wiring in the airbag system. This also applies to steering wheel covers, the dashboard, the seats, the roof pillars and the sides of the headliner. ◀

 In the case of a malfunction, deactivation and after triggering of the airbags

Do not touch the individual components immediately after the system has been triggered; otherwise, there is the danger of burns.

Only have the airbags checked, repaired or dismantled and the airbag generator scrapped by your authorized dealership or a workshop that has the necessary authorization for handling explosives.

Non-professional attempts to service the system could lead to failure in an emergency or undesired triggering of the airbag, either of which could result in injury. ◀

Warnings and information on the airbags are also found on the sun visors.

## Automatic deactivation of the front passenger airbags

The system determines whether the front passenger seat is occupied by measuring the resistance of the human body.

The front, knee, and side airbag on the front passenger side are activated or deactivated accordingly.

 Leave feet in the footwell

Make sure that the front passenger keeps his or her feet in the footwell; otherwise, the front passenger airbags may not function properly. ◀

 Child restraint fixing system in the front passenger seat

Before transporting a child on the front passenger seat, see the safety notes and instructions under Children on the front passenger seat. ◀

## Malfunction of the automatic deactivation system

When transporting older children and adults, the front passenger airbags may be deactivated in certain sitting positions. In this case, the indicator lamp for the front passenger airbags lights up.

In this case, change the sitting position so that the front passenger airbags are activated and the indicator lamp goes out.

If it is not possible to activate the airbags, have the person sit in the rear.

To make sure that the occupied seat cushion can be evaluated correctly

- ▷ Do not attach covers, cushions, ball mats or other items to the front passenger seat unless they are specifically recommended by the manufacturer of your vehicle.
- ▷ Do not place objects under the seat that could press against the seat from below.

## Indicator lamp for the front passenger airbags



The indicator lamp for the front passenger airbags indicates the operating state of the front passenger airbags.

The lamp indicates whether the airbags are activated or deactivated.

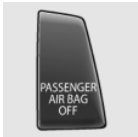

- ▶ The indicator lamp lights up when a child who is properly seated in a child restraint fixing system intended for that purpose is detected on the seat or the seat is empty. The airbags on the front passenger side are not activated.

- ▶ The indicator lamp does not light up when, for example, a correctly seated person of sufficient size is detected on the seat. The airbags on the front passenger side are activated.

Most child seats are detected by the system, especially the child seats required by the NHTSA at the time the vehicle was manufactured. After installing a child seat, make sure that the indicator lamp for the front passenger airbags lights up. This indicates that the child seat has been detected and the front passenger airbags are not activated.

## Strength of the driver's and front passenger airbag

The strength with which the driver's and front passenger airbags are triggered depends on the position of the driver's and front passenger seats.

To maintain the accuracy of this function over the long-term, calibrate the front seats when a

corresponding message appears on the Control Display.

## Calibrating the front seats

A corresponding message appears on the Control Display.

1. Move the respective seat forward all the way.
2. Move the respective seat forward again. It moves forward briefly.
3. Readjust the seat to the desired position.

The calibration procedure is completed when the message on the Control Display disappears.

If the message continues to be displayed, repeat the calibration.

If the message does not disappear after a repeat calibration, have the system checked as soon as possible.



Unobstructed area of movement

Ensure that the area of movement of the seats is unobstructed to avoid personal injury or damage to objects. ◀

## TPM Tire Pressure Monitor\*

### The concept

Monitoring of the tire inflation pressure in the four mounted tires. The system reports when the tire inflation pressure has dropped considerably in one or several tires.

### Conditions for operation

The system must have been reset when the inflation pressure was correct; otherwise, reliable signaling of a flat tire is not ensured. Always use wheels with TPM electronics to ensure that the system will operate properly. Reset the system after each correction of the tire inflation pressure and after every tire or wheel change.

### System limits



Sudden tire damage

Sudden serious tire damage caused by external influences cannot be indicated in advance. ◀

The system does not operate correctly if it has not been reset. For example, a flat tire may be indicated despite correct tire inflation pressures.

The system is inactive and cannot indicate a flat tire:

- ▶ For a mounted wheel without TPM electronics.
- ▶ When the TPM is disturbed by other systems or devices with the same radio frequency.

## Status display

The tire and system status is indicated by the color of the tires.

A change in the tire inflation pressure during driving is taken into account.

A correction is only necessary if indicated by TPM.

## Green

The tire inflation pressure is equal to the target state.

## One wheel is yellow

A flat tire or major drop in inflation pressure in the indicated tire.

## All wheels are yellow

- ▶ A flat tire or major drop in inflation pressure in several tires.
- ▶ The system was not reset after a wheel change.

## Gray

The system cannot detect a flat tire. Reasons for this may be:

- ▶ TPM is being reset.
- ▶ Disturbance by systems or devices with the same radio frequency.
- ▶ Malfunction.

## Resetting the system

Reset the system after each correction of the tire inflation pressure and after every tire or wheel change.

1. "Vehicle Info"
2. "Vehicle status"
3. "Tire Pressure Monitor - TPM"
4. "Reset TPM"

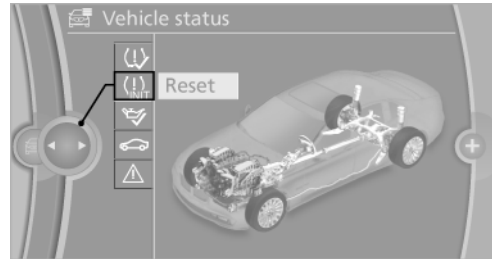

5. Start the engine - do not drive away.
6. Reset the tire pressure using "Reset".
7. Drive away.

The tires are shown in gray and "Resetting TPM..." is displayed.

After driving for a few minutes, the set tire inflation pressures are applied as set values. The resetting process is completed automatically during driving. The tires are shown in green and "TPM active" is shown on the Control Display.

The trip can be interrupted at any time. If you drive away again, the process resumes automatically.

If a flat tire is detected during a reset, all tires are displayed in yellow.

## Low tire pressure message



The yellow warning lamp lights up. A message appears on the Control Display. In addition, a signal sounds.

- ▶ There is a flat tire or a major loss in tire inflation pressure.
- ▶ The system was not reset after a wheel change.

Cautiously reduce the vehicle speed to below 50 mph/80 km/h.

 Do not continue driving without run-flat tires

Do not continue driving if the vehicle is not equipped with run-flat tires; continued driving may result in serious accidents. ◀

### Continued driving with a flat tire

Possible driving distance with complete loss of tire inflation pressure:

- ▷ With a light load: 1 to 2 people without luggage: Approx. 155 miles/250 km.
- ▷ With a medium load: 2 people, trunk full, or 4 people without luggage: Approx. 94 miles/150 km.
- ▷ With a full load: 4 people, trunk full: Approx. 30 miles/50 km.

 Continued driving with a flat tire  
Drive moderately and do not exceed a speed of 50 mph/80 km/h.

A loss of tire inflation pressure results in a change in the handling characteristics, e.g., reduced lane stability during braking, a longer braking distance and altered self-steering properties. ◀

 Final failure of tire  
Vibrations or loud noises while driving can indicate the final failure of the tire. Reduce speed and stop; otherwise, pieces of the tire could come loose and cause an accident. Do not continue driving and contact your authorized dealership. ◀

### Message when not reset

 The yellow warning lamp lights up. A message appears on the Control Display.

The system was not reset, e.g., after a wheel change.

Check the tire inflation pressure and reset the system.

### Status display

The current status of the TPM Tire Pressure Monitor can be displayed on the Control Display, e.g., whether or not the TPM is active.

1. "Vehicle Info"
2. "Vehicle status"
3. "Tire Pressure Monitor - TPM"

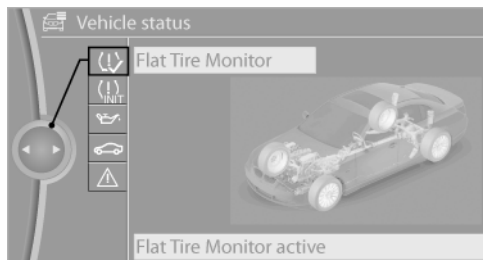

The status is displayed.

### Malfunction

 The yellow warning lamp flashes and then lights up continuously. The tires are displayed in gray on the Control Display. No flat tire can be detected.

Display in the following situations:

- ▷ Malfunction: have the system checked.
- ▷ A wheel without TPM electronics is mounted.
- ▷ Disturbance by systems or devices with the same radio frequency: after leaving the area of the disturbance, the system automatically becomes active again.

Each tire, including the spare (if provided) should be checked monthly when cold and inflated to the inflation pressure recommended by the vehicle manufacturer on the vehicle placard or tire inflation pressure label. (If your vehicle has tires of a different size than the size indicated on the vehicle placard or tire inflation pressure label, you should determine the proper tire inflation pressure for those tires.) As an added safety feature, your vehicle has been equipped with a tire pressure monitoring system (TPMS) that illuminates a low tire pressure telltale when one or more of your tires is significantly under-inflated. Accordingly, when the low tire pressure

telltale illuminates, you should stop and check your tires as soon as possible, and inflate them to the proper pressure. Driving on a significantly under-inflated tire causes the tire to overheat and can lead to tire failure. Under-inflation also reduces fuel efficiency and tire tread life, and may affect the vehicle's handling and stopping ability. Please note that the TPMS is not a substitute for proper tire maintenance, and it is the driver's responsibility to maintain correct tire pressure, even if under-inflation has not reached the level to trigger illumination of the TPMS low tire pressure telltale. Your vehicle has also been equipped with a TPMS malfunction indicator to indicate when the system is not operating properly. The TPMS malfunction indicator is combined with the low tire pressure telltale. When the system detects a malfunction, the telltale will flash for approximately one minute and then remain continuously illuminated. This sequence will continue upon subsequent vehicle start-ups as long as the malfunction exists. When the malfunction indicator is illuminated, the system may not be able to detect or signal low tire pressure as intended. TPMS malfunctions may occur for a variety of reasons, including the installation of replacement or alternate tires or wheels on the vehicle that prevent the TPMS from functioning properly. Always check the TPMS malfunction telltale after replacing one or more tires or wheels on your vehicle to ensure that the replacement or alternate tires and wheels allow the TPMS to continue to function properly.

## FTM Flat Tire Monitor\*

### The concept

The system detects a pressure loss on the basis of speed differences between the individual wheels while driving.

In the event of a pressure loss, the diameter and therefore the rotational speed of the corresponding wheel changes. This is detected and reported as a flat tire.

### Functional requirements

The system must have been initialized when the tire inflation pressure was correct; otherwise, reliable signaling of a flat tire is not ensured. Initialize the system after each correction of the tire inflation pressure and after every tire or wheel change.

### System limits



Sudden tire damage

Sudden serious tire damage caused by external influences cannot be indicated in advance. ◀

A natural, even pressure loss in all four tires cannot be detected.

The system could be delayed or malfunction in the following situations:

- ▶ When the system has not been initialized.
- ▶ When driving on a snowy or slippery road surface.
- ▶ Sporty driving style: slip in the drive wheels, high lateral acceleration.
- ▶ When driving with snow chains\*.

### Initialization

The initialization process adopts the set inflation tire pressures as reference values for the detection of a flat tire. Initialization is started by confirming the inflation pressures.

Do not initialize the system when driving with snow chains\*.

1. "Vehicle Info"
2. "Vehicle status"
3. "Reset"

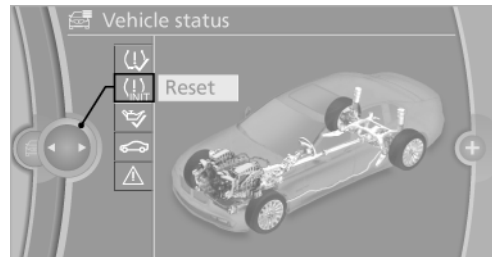

4. Start the engine - do not drive away.
5. Start the initialization with "Reset".
6. Drive away.

The initialization is completed while driving, which can be interrupted at any time.

The initialization automatically continues when driving resumes.

## Indication of a flat tire



The yellow warning lamp and the vehicle symbol light up. A message appears on the Control Display. In addition, a signal sounds.

There is a flat tire or a major loss in tire inflation pressure.

1. Carefully reduce your speed to a maximum of 50 mph/80 km/h.

Avoid sudden braking and steering maneuvers. Do not increase the speed again.



Do not continue driving without run-flat tires

Do not continue driving if the vehicle is not equipped with run-flat tires; continued driving may result in serious accidents. ◀

2. Check the air pressure in all four tires at the next opportunity.

If the tire inflation pressure in all tires is correct, the Flat Tire Monitor may not have been initialized. In this case, initialize the system.

## Continued driving with a flat tire

Possible driving distance with complete loss of tire inflation pressure:

- ▶ With a light load: 1 to 2 people without luggage: Approx. 155 miles/250 km.
- ▶ With a medium load: 2 people, trunk full, or 4 people without luggage: Approx. 94 miles/150 km.
- ▶ With a full load: 4 people, trunk full: Approx. 30 miles/50 km.



Continued driving with a flat tire

Drive moderately and do not exceed a speed of 50 mph/80 km/h.

A loss of tire inflation pressure results in a change in the handling characteristics, e.g., reduced lane stability during braking, a longer braking distance and altered self-steering properties. ◀



Final failure of tire

Vibrations or loud noises while driving can indicate the final failure of the tire. Reduce speed and stop; otherwise, pieces of the tire could come loose and cause an accident. Do not continue driving and contact your authorized dealership. ◀

## Status display

The current status of the Flat Tire Monitor can be displayed on the Control Display, e.g., whether or not the FTM is active.

1. "Vehicle Info"
2. "Vehicle status"
3. "Flat Tire Monitor"

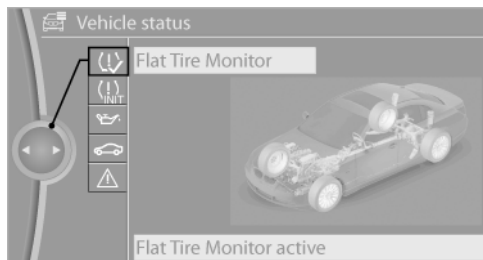

The status is displayed.

## Lane departure warning\*

### The concept

This system issues a warning at speeds above approx. 40 mph/65 km/h if the vehicle is about to leave the lane on roads with lane lines.

The steering wheel begins vibrating gently.

The system does not provide a warning if the turn signal is set before leaving the lane.



## Switching on/off



Press the button.

- ▷ On: the LED lights up.
- ▷ Off: the LED goes out.

The system can issue warnings at speeds above approx. 40 mph/65 km/h.

The state is stored for the remote control currently in use.

## Display

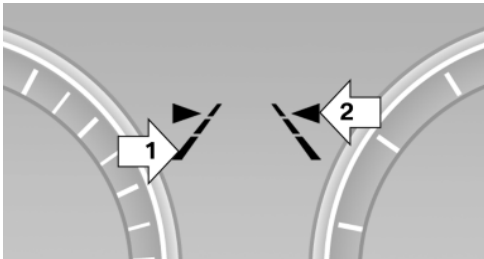

- ▷ Lines, arrow 1: the system is activated.
- ▷ Arrows, arrow 2: at least one lane line was detected and warnings can be issued.

## Issued warning

If you leave the lane and if a lane line has been detected, the steering wheel begins vibrating.

If the turn signal is set before changing the lane, a warning is not issued.

## End of warning

The warning ends:

- ▷ Automatically after approx. 3 seconds.
- ▷ When returning to your own lane.
- ▷ When braking hard.

- ▷ When using the turn signal.

## System limits



**Personal responsibility**

The system cannot serve as a substitute for the driver's personal judgment of the course of the road and the traffic situation.

In the event of a warning, do not jerk the steering wheel, as you may lose control over the vehicle. ◀

The system may not be fully functional in the following situations:

- ▷ In heavy fog, rain or snowfall.
- ▷ In the event of worn, poorly visible, merging, diverging, or multiple lines such as in construction areas.
- ▷ When lane lines are covered in snow, ice, dirt or water.
- ▷ In tight curves or on narrow lanes.
- ▷ When the lines are covered by objects.
- ▷ When driving very close to the vehicle in front.
- ▷ When driving toward bright lights.
- ▷ When the windshield in front of the interior rearview mirror is fogged over, dirty or covered with stickers, etc.

## Malfunctions

### Steering wheel vibration

Frequent activation of the steering wheel vibration causes the system to overheat.

This causes the lane departure warning to become deactivated.

Let the system cool and reactivate it by pressing the button.

## Sensor view field

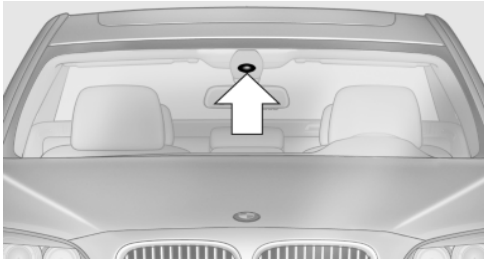

The view field of the sensor is located on the front of the interior rearview mirror.

Do not cover this area with stickers, etc.

Clean the view field, refer to page 252.

## Active Blind Spot Detection\*

### The concept

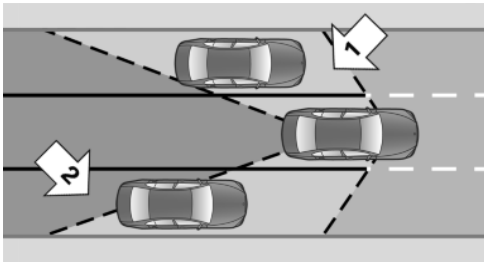

Two radar sensors below the rear bumper monitor the area behind and next to the vehicle at speeds above approx. 30 mph/50 km/h.

The system indicates whether there are vehicles in the blind spot, arrow 1, or approaching from behind on the adjacent lane, arrow 2.

The lamp in the exterior mirror housing lights up dimly.

Before you change lanes after setting the turn signal, the system issues a warning in the situations described above.

The lamp in the housing of the exterior mirror flashes and the steering wheel vibrates.

## Switching on/off



Press the button.

- ▷ On: the LED lights up.
- ▷ Off: the LED goes out.

The system can issue warnings at speeds above approx. 30 mph/50 km/h.

The state is stored for the remote control currently in use.

### Display

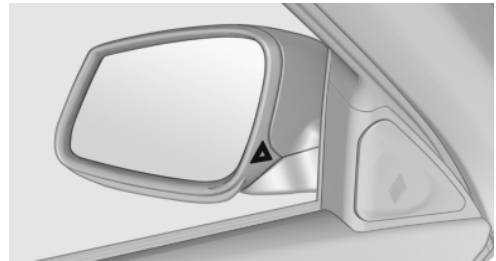

### Information stage

The dimmed lamp in the mirror housing indicates when there are vehicles in the blind spot or approaching from behind.

### Warning

If the turn signal is set while a vehicle is in the critical zone, the steering wheel vibrates briefly and the lamp in the mirror housing flashes brightly.

The warning stops when the turn signal is switched off or the other vehicle leaves the critical zone.

## System limits



### Personal responsibility

The system cannot serve as a substitute for the driver's personal judgment of the traffic situation.

In the event of a warning, do not jerk the steering wheel, as you may lose control over the vehicle. ◀

The system may not be fully functional in situations such as the following:

- ▷ When a vehicle is approaching at a speed much faster than your own.
- ▷ In heavy fog, rain or snowfall.
- ▷ In tight curves or on narrow lanes.

## Malfunctions

### Steering wheel vibration

Frequent activation of the steering wheel vibration causes the system to overheat.

This causes Active Blind Spot Detection to become deactivated.

Let the system cool and reactivate it by pressing the button.

### Radar sensors



The radar sensors are located under the rear bumper.

The system may not be fully functional in situations such as the following:

- ▷ Dirty or icy bumper.
- ▷ Stickers on the bumper.

A message is displayed when the system is not fully functional.

## For US owners only

The transmitter and receiver units comply with part 15 of the FCC/Federal Communication Commission regulations. Operation is governed by the following:

FCC ID:

- ▷ NBG009014A.

Compliance statement:

This device complies with part 15 of the FCC Rules. Operation is subject to the following two conditions:

- ▷ This device may not cause harmful interference, and
- ▷ this device must accept any interference received, including interference that may cause undesired operation.

Any unauthorized modifications or changes to these devices could void the user's authority to operate this equipment.

## Brake force display\*

### The concept

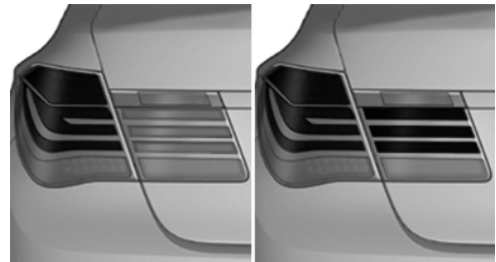

- ▷ During normal brake application, the outer brake lamps light up.
- ▷ During heavy brake application, the inner brake lamps light up in addition.

# Driving stability control systems

## Antilock Brake System ABS

ABS prevents locking of the wheels during braking.

The vehicle remains steerable even during full brake applications, thus increasing active safety.

ABS is operational every time you start the engine.

## Brake assistant

When you apply the brakes rapidly, this system automatically produces the maximum braking force boost. It thus helps to achieve the shortest possible braking distance during full braking. This system utilizes all of the benefits provided by ABS.

Do not reduce the pressure on the brake pedal for the duration of the full braking.

## Adaptive brake assistant

In combination with the Active Cruise Control, this system ensures that the brakes respond even more rapidly when braking in critical situations. Refer also to [Collision warning, refer to page 112](#).

## DSC Dynamic Stability Control

### The concept

DSC prevents traction loss in the driving wheels when driving away and accelerating.

DSC also recognizes unstable vehicle conditions, such as fishtailing or nose-diving. Subject to physical limits, DSC helps to keep the vehicle on a steady course by reducing engine speed and by applying brakes at individual wheels.



Adjust your driving style to the situation

An appropriate driving style is always the responsibility of the driver.

The laws of physics cannot be repealed, even with DSC.

Therefore, do not reduce the additional safety margin by driving in a risky manner. ◀

### Deactivating/activating the DSC OFF program

The program can be deactivated/activated via [Dynamic Driving Control, refer to page 103](#).

### For better control



The indicator lamp flashes: DSC controls the drive forces and brake forces.

The indicator lamp lights up: DSC has failed.

## DTC Dynamic Traction Control

### The concept

The DTC system is a variant of the DSC in which forward momentum is optimized.

The system ensures maximum forward momentum on special road conditions, e.g., unplowed snowy roads, but driving stability is limited.

It is therefore necessary to drive with appropriate caution.

You may find it useful to briefly activate DTC under the following special circumstances:

- ▶ When driving in slush or on uncleared, snow-covered roads.
- ▶ When rocking the vehicle or driving off in deep snow or on loose surfaces.
- ▶ When driving with snow chains.

## Deactivating/activating DTC Dynamic Traction Control

The system can be deactivated/activated via the TRACTION and SPORT+ programs of the Dynamic Driving Control, refer to page 103.

## xDrive\*

xDrive is the all-wheel-drive system of your vehicle. Concerted action by the xDrive and DSC further optimize traction and driving dynamics. The xDrive all-wheel-drive system variably distributes the drive forces to the front and rear axles as demanded by the driving situation and road surface.

## HDC Hill Descent Control\*

HDC is a downhill driving assistant that automatically controls vehicle speed on steep downhill gradients. Without requiring brake application, the vehicle moves at slightly more than twice walking speed.

HDC can be activated at vehicle speeds below approx. 22 mph/35 km/h. When the vehicle moves down steep gradients at speeds below approx. 22 mph/35 km/h, it automatically reduces speed down to slightly more than normal walking speed and then keeps it constant.

While you are actively braking, the system is on standby. The system does not brake the vehicle during this time.

## Increasing or decreasing vehicle speed

You can specify your desired speed in the range from approx. 4 mph/6 km/h to approx. 15 mph/25 km/h using the rocker switch of the cruise control on the steering wheel. You can change the vehicle speed by depressing the accelerator lightly.

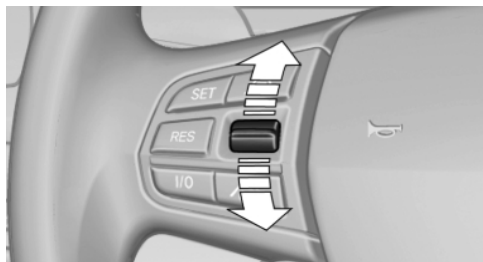

- Press up the rocker switch to the point of resistance: the speed increases gradually.
- Press up the rocker switch past the point of resistance: the speed increases while the rocker switch is pressed.
- Press down the rocker switch to the point of resistance: the speed decreases gradually.
- Press down the rocker switch past the point of resistance: when driving forward, the speed decreases to approx. 6 mph/10 km/h; when driving backwards, the speed decreases to approx. 4 mph/6 km/h.

## Activating HDC



-  Press the button; the LED above the button lights up.

## Deactivating HDC

-  Press the button again and the LED goes out. HDC is automatically deactivated above approx. 37 mph/60 km/h.

## Display in the instrument cluster



The selected speed is displayed in the speedometer.

- ▷ Green: the system is actively braking the vehicle.
- ▷ Orange: the system is on standby.

## Malfunction

A message is displayed in the instrument cluster. HDC is not available, e.g., due to elevated brake temperatures.

## Dynamic Drive\*

### The concept

Dynamic Drive reduces the lateral inclination of the vehicle that occurs during rapid driving in curves or during quick evasive maneuvers.

Driving stability and driving comfort are increased under all driving conditions. The system utilizes active stabilizer bars on the front and rear axles that react immediately to all driving situations.

### Programs

The system offers two different programs.

The programs can be selected via [Dynamic Driving Control](#), refer to page 103.

### SPORT

Sporty tuning for greater driving agility.

### NORMAL

Comfort-oriented tuning for optimal comfort.

## Dynamic Damping Control\*

### The concept

This system reduces undesirable vehicle motion when using a dynamic driving style or traveling on uneven road surfaces.

The system enhances driving dynamics and comfort as required for the road surface and driving style.

## Programs

The system offers three different programs.

The programs can be selected via [Dynamic Driving Control](#), refer to page 103.

### SPORT

Consistently sporty tuning of the shock absorbers for greater driving agility.

### NORMAL

Balanced tuning between the COMFORT and SPORT programs.

### COMFORT

Comfort-oriented tuning of the shock absorbers for optimal traveling comfort.

## Integral Active Steering\*

### The concept

Integral Active Steering is a combination of Active Steering and rear axle steering.

Active Steering varies the steering angle of the wheels in relation to the steering wheel movement as a function of the speed.

At speeds up to approx. 37 mph/60 km/h, e.g., in curves, the steering angle is increased, i.e., steering becomes more direct.

The rear axle steering acts to increase maneuverability by turning the rear wheels slightly in a direction opposite to the front wheels.

At higher speeds, the steering angle is increasingly reduced.

The rear wheels are turned to the same angle as the front wheels.

In critical situations, Integral Active Steering can specifically steer the front and rear wheels to stabilize the vehicle before the driver intervenes, e.g., when braking where road conditions differ on the left and right sides of the vehicle.

## Initializing

In rare cases, it may become necessary to initialize the Integral Active Steering.



The warning lamp lights up. A message appears on the Control Display.

1. With the engine running, turn the steering wheel all the way to the left and right several times in a uniform manner until the warning lamp disappears.
2. Have the system checked if the warning lamp does not go out after moving the steering wheel approx. 6 times or if the steering wheel is at an angle.

## Using snow chains

Ensure that the rear axle steering is deactivated when [using snow chains](#), refer to [page 231](#).

## Programs

The system offers two different programs.

The programs can be selected via [Dynamic Driving Control](#), refer to [page 103](#).

### SPORT

Consistently sporty tuning of the Integral Active Steering for greater driving agility.

### NORMAL

Balanced tuning of the Integral Active Steering for optimal traveling comfort.

### Malfunction

In the event of a malfunction, the steering wheel must be turned further, while the vehicle responds more sensitively to steering wheel movements in the higher speed range.

The stability-enhancing intervention may be deactivated.

Proceed cautiously and drive defensively.



Have the system checked.

## Dynamic Driving Control

### The concept

Dynamic Driving Control can be used to adjust the driving dynamics of the vehicle. Several programs are available for this purpose; they can be activated using the two Dynamic Driving Control buttons.

### Operating the programs

Press the button	Program
	DSC OFF TRACTION
	SPORT + SPORT NORMAL COMFORT*

For Dynamic Damper Control\*, the lower button is labeled with COMFORT.

### Automatic program change

The system automatically switches to NORMAL in the following situations:

- ▷ Failure of Integral Active Steering\*.
- ▷ Failure of Dynamic Damping Control\*.
- ▷ The vehicle has a flat tire.

### DSC OFF

Driving stability is limited during acceleration and when driving in bends.

Stabilizing interventions by the Integral Active Steering\* system are only performed by the rear axle steering.

To increase vehicle stability, activate DSC again as soon as possible.

### Activating DSC OFF



Press and hold the button, but not longer than approx. 10 seconds, until the indicator lamp for the DSC lights up in the in-

strument cluster and DSC OFF is displayed in the tachometer.

The DSC system is switched off.

## Deactivating DSC OFF



Press the button.

DSC OFF and the DSC indicator lamp go out.

## For better control

DSC OFF is displayed in the tachometer.



The indicator lamp lights up: DSC is deactivated.

## TRACTION

Maximum traction on loose road surfaces. DTC Dynamic Traction Control is switched on. Driving stability is limited during acceleration and when driving in bends.

## Activating TRACTION



Press the button.

TRACTION is displayed in the tachometer.

The DSC indicator lamp in the instrument cluster lights up.

## Deactivating TRACTION



Press the button again.

TRACTION and the DSC indicator lamp go out.

## For better control

TRACTION is displayed in the tachometer.



The indicator lamp lights up: DTC Dynamic Traction Control is activated.

## SPORT+

Sporty driving with a sporty tuning of the suspension and reduced driving stability.

Dynamic Traction Control is switched on.

The driver handles several of the stabilization tasks.

## Activating SPORT+



Press the button repeatedly until SPORT+ appears in the tachometer and the DSC indicator lamp lights up in the instrument cluster.

## For better control

SPORT+ is displayed in the tachometer.



The indicator lamp lights up: DTC Dynamic Traction Control is activated.

## SPORT

Consistently sporty tuning of the suspension for greater driving agility with maximum driving stabilization.

The program can be configured to individual specifications.

The configuration is stored for the remote control currently in use.

## Activating SPORT



Press the button repeatedly until SPORT+ appears in the tachometer.

## Configuring SPORT

When the [display is activated on the Control Display, refer to page 105](#), the sport program can be set to individual specifications.

After the sport program is activated, select "Configure SPORT mode" on the displayed panel and configure the program.

Optionally, the sport program can be configured before it is activated:

1. "Settings"



## 2. "SPORT mode"

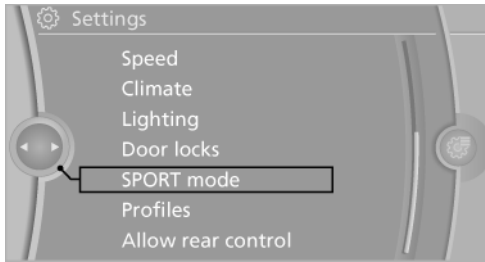

## 3. Configure the program.

This configuration is retrieved when the sport program is activated.

### NORMAL

For a balanced tuning between COMFORT and SPORT with maximum driving stabilization.

### Activating NORMAL



Press the button repeatedly until the program display in the tachometer goes out.

In certain situations, the system automatically changes to the NORMAL program, [automatic program change, refer to page 103](#).

### COMFORT\*

Comfort-oriented tuning of the shock absorbers for optimal traveling comfort with maximum driving stabilization.

### Activating COMFORT



Press the button repeatedly until COMFORT appears in the tachometer.

## Displays in the instrument cluster

### Selected program

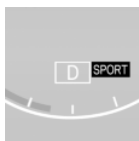

The selected program is displayed in the tachometer.

## Program selection

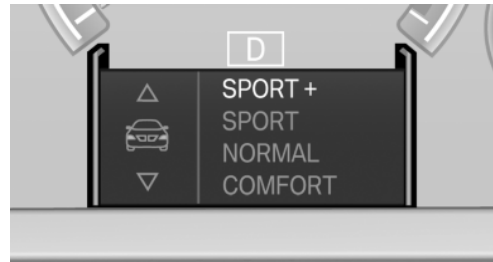

Pressing the button displays a list of the selectable programs.

### Display on the Control Display

Program changes can be displayed briefly on the Control Display.

To do so, make the following settings:

1. "Settings"
2. "Control display"

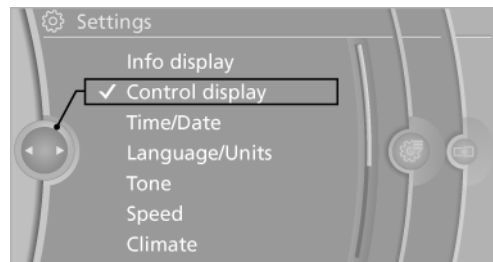

3. "Display driving settings"

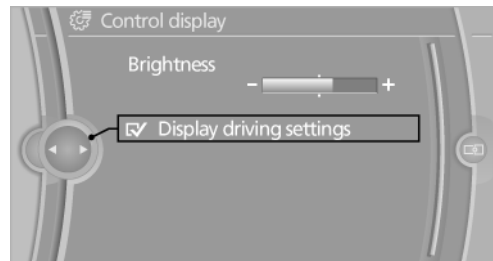

## Drive-off assistant

This system supports driving away on gradients. The parking brake is not required.

1. Hold the vehicle in place with the foot brake.
2. Release the foot brake and drive away without delay.

After the foot brake is released, the vehicle is held in place for approx. 2 seconds.

Depending on the vehicle load, the vehicle may roll back slightly.



Driving off without delay

After releasing the foot brake, start driving without delay, since the drive-off assistant will not hold the vehicle in place for more than approx. 2 seconds and the vehicle will begin rolling back. ◀

# Driving comfort

## Active Cruise Control with Stop & Go function, ACC\*

### The concept

This system can be used to select a desired speed that the vehicle will maintain automatically on clear roads.

To the extent possible, the system automatically adjusts the speed to a slower vehicle ahead of you.

The distance that the vehicle maintains to the vehicle ahead of you can be varied.

For safety reasons, it depends on the speed.

To maintain a certain distance, the system automatically decelerates, applies the brakes lightly, or accelerates again if the vehicle ahead begins moving faster.

If the vehicle ahead of you brakes to a halt, the system is able to detect this within the given system limits. If the vehicle ahead of your drives away again from a halt, your vehicle is able to accelerate if operated accordingly.

Even if some time passes before the vehicle drives away again, the BMW can still be accelerated automatically and simply.

As soon as the road is clear, it accelerates to the desired speed.

The speed is also maintained on downhill gradients, but may not be maintained on uphill slopes if engine power is insufficient.

### Buttons at a glance



- 1 System on/off, interrupt
- 2 Resume speed
- 3 Store speed
- 4 Increase distance
- 5 Change/maintain speed
- 6 Reduce distance

### Switching on/off and interrupting cruise control

#### Switching on

 Press the button on the steering wheel.

The indicator lamps in the instrument cluster light up and the marking in the speedometer is set to the current speed.

Cruise control can be used.

When Active Cruise Control is activated, there may be a program change in the [Dynamic Driving Control](#), refer to page 103.

#### Switching off

 Deactivated or interrupted system

If the system is deactivated or interrupted, actively intervene by braking and, if necessary, with evasive maneuvers; otherwise, there is the danger of an accident occurring. ◀

If switching off the system while stationary, depress the brake at the same time.



Press the button

- ▷ If active: press twice.
- ▷ If interrupted: press once.

The displays go out. The stored desired speed and distance are deleted.

### Interrupting



When active, press the button.

If interrupting the system while stationary, depress the brake at the same time.

The system is automatically interrupted if:

- ▷ The brakes are applied.
- ▷ Transmission position D is disengaged.
- ▷ DTC Dynamic Traction Control is activated or DSC is deactivated.
- ▷ DSC is actively controlling stability.
- ▷ The safety belt and the driver's door are opened when the vehicle is standing.
- ▷ The system has not detected objects for an extended period, e.g., on a road with very little traffic without road edge line markings.
- ▷ The radar sensors are dirty.

### Maintaining/storing the speed



Press the button.

When the system is switched on, the current speed is maintained and stored as the desired speed.

It is displayed in the speedometer and briefly displayed in the instrument cluster, [Displays in the instrument cluster, refer to page 109](#).

### Changing the speed



Adapting the desired speed

Adapt the desired speed to the road conditions and be ready to brake at all times; otherwise, there is the danger of an accident occurring. ◀



Speed differences

Great speed differences with vehicles driving ahead of you, e.g., when rapidly approaching a truck or when another vehicle swerves into your own lane, cannot be compensated for by the system. ◀

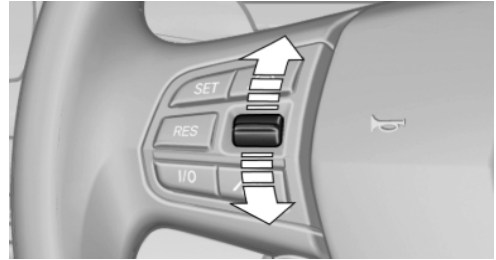

Press the rocker switch up or down repeatedly until the desired speed is set.

If active, the displayed speed is stored and the vehicle reaches the stored speed if the road is clear.

- ▷ Each time the rocker switch is pressed to the point of resistance, the desired speed increases or decreases by approx. 1 mph/ 1 km/h.
- ▷ Each time the rocker switch is pressed past the point of resistance, the desired speed increases or decreases by a maximum of 5 mph/10 km/h. Max. adjustable speed: 110 mph/180 km/h.

Hold the rocker switch in position to repeat the action.

The rocker switch can be pressed while interrupted to maintain and store the current speed.

### Distance



Selecting a distance

Adjust the distance according to the traffic and weather conditions; otherwise, there is the danger of an accident occurring. Maintain the prescribed safety distance. ◀

### Reduce distance



Press the button repeatedly until the desired distance is set.

The selected [distance, refer to page 109](#), is displayed in the instrument cluster.

## Increase distance



Press the button repeatedly until the desired distance is set.

The selected **distance**, refer to page 109, is displayed in the instrument cluster.

## Calling up the desired speed and distance

### While driving



Press the button with the system switched on.

In the following cases, the stored speed value is deleted and cannot be called up again:

- ▶ When the system is switched off.
- ▶ When the ignition is switched off.

### While standing



Before leaving the vehicle

Before leaving the vehicle with the engine running, engage position P of the automatic transmission and apply the parking brake. Otherwise, the vehicle may begin to roll. ◀

- ▶ The vehicle was braked to a halt by the system.

When the marking in the speedometer is orange:

The vehicle ahead of you drives away: to accelerate, press the accelerator briefly, or press the RES button, SET button, or rocker switch. The marking turns green again and your vehicle follows the vehicle ahead of you.

Rolling bars in the distance indicator mean that the vehicle ahead of you has driven off.

- ▶ You actively braked your vehicle to a halt by depressing the brake pedal and it is standing behind another vehicle:

1.  Press the button to call up a stored desired speed.
2. Release the brake pedal.

3. Press the accelerator briefly, or press the RES button, SET button, or rocker switch, when the vehicle ahead of you drives away.

## Displays in the instrument cluster

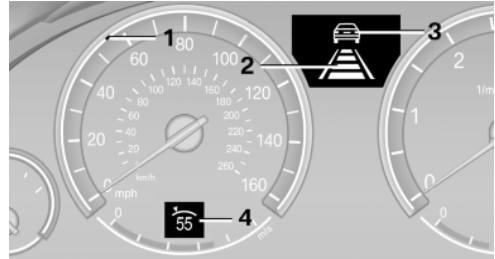

- 1 Display of desired speed
- 2 Distance to vehicle ahead of you
- 3 Vehicle symbol
- 4 Brief status display

## Desired speed

### Marking in the speedometer



- ▶ The marking lights up in green: the system is active.
- ▶ The marking lights up in orange: the system has been interrupted.
- ▶ The marking does not light up: the system is switched off.

### Brief display in speedometer



Selected desired speed

If --- appears briefly, conditions may not be adequate to operate the system.

## Distance to vehicle ahead of you

The selected distance to the vehicle driving ahead of you is shown.

## Distance display



Distance 1



Distance 2



Distance 3



Distance 4

This value is set after the system is switched on.



The system is interrupted or distance control is deactivated because the accelerator was depressed while no vehicle was detected.



Distance control was deactivated because the accelerator was depressed while a vehicle was detected.

Rolling bars: the detected vehicle has driven away.

## Indicator/warning lamps



Personal responsibility

The indicator and warning lamps do not relieve the driver of the responsibility to adapt his or her desired driving speed and style to the traffic conditions. ◀



The vehicle symbol lights up in orange:

A vehicle has been detected ahead of you.



The vehicle symbol flashes orange:

The conditions are not adequate for operating the system.

The system is deactivated but applies the brakes until you actively assume control by depressing the brake pedal or the accelerator.



The vehicle symbol flashes red and an acoustic signal sounds:

You are requested to intervene by braking or making an evasive maneuver.

## System limits

## Speed range

Best results are achieved when using the system on well-developed roads and highways. The desired speed can be selected between 20 mph/30 km/h and 110 mph/180 km/h. The system can also be activated when stationary. Comply with the legal speed limit in every situation when using the system.

## Detection range

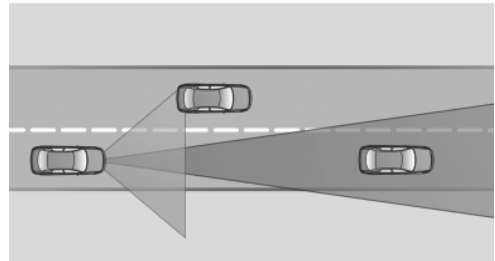

The detection capacity of the system and the automatic braking capacity are limited.

For example, the following situations may not be detected:

- ▶ Vehicles in front in stop & go traffic that brake suddenly during an acceleration.
- ▶ Two-wheeled vehicles ahead of you.



Limited detection capacity

Because of the limits to the detection capacity, you should be alert at all times so that you can intervene actively, if necessary; otherwise, there is the danger of an accident occurring. ◀

## Deceleration

The system does not decelerate when a stationary obstacle is located in the same lane, e.g., a vehicle at a red traffic light or at the end of a traffic congestion.

The system also does not respond to:

- ▶ Pedestrians or similarly slow road users.
- ▶ Red traffic lights.
- ▶ Stationary objects.
- ▶ Cross traffic.

▷ Approaching traffic.



No warnings

A warning may not be issued when approaching a stationary or very slow-moving obstacle. You must react yourself; otherwise, there is the danger of an accident occurring. ◀

## Swerving vehicles

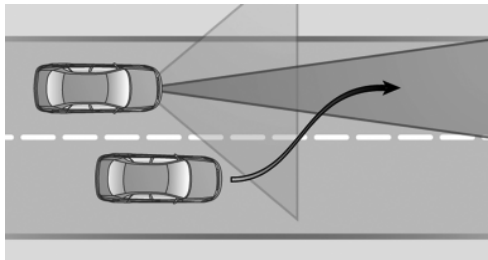

A vehicle driving in front of you is not detected until it is completely within the same lane as your vehicle.



Swerving vehicles

If a vehicle driving ahead of you suddenly swerves into your lane, the system may not be able to automatically restore the selected distance. This also applies to major speed differences to vehicles driving ahead of you, e.g., when rapidly approaching a truck. When a vehicle driving ahead of you is reliably detected, the system requests that the driver intervene by braking and carrying out evasive maneuvers, if necessary. You must react yourself; otherwise, there is the danger of an accident occurring. ◀

## Unexpected lane change

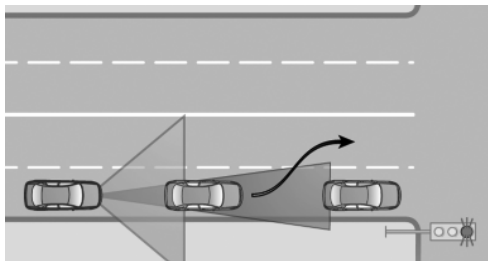

If a vehicle ahead of you unexpectedly moves into your lane from behind a stopped vehicle,

you yourself must react, as the system does not react to stopped vehicles.

## Cornering

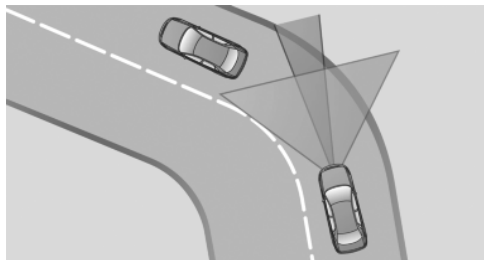

If the desired speed is too high for a curve, the speed is reduced in the curve.

Curves are not detected in advance. Drive into a curve at an appropriate speed.

In tight curves, situations may result due to the restricted detection range of the system in which a vehicle driving ahead of you may not be detected at all, or not until after a considerable delay.

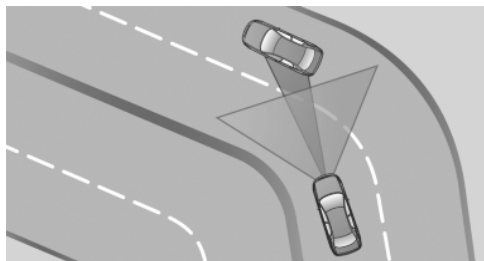

When approaching a curve, the system may react briefly to the vehicles in the next lane due to the bend of the curve. Any deceleration of the vehicle by the system can be compensated for by briefly accelerating. After the accelerator pedal is released, the system becomes active again and independently controls the speed.

## Driving away

In some situations, the vehicle cannot drive away after confirmation by the driver, e.g., on steep inclines, with a heavy trailer or behind bumps in the road.

## Automatic deactivation

For legal reasons, the system is deactivated at speeds below 20 mph/30 km/h in the vicinity of radio astronomy stations.

## Radar sensors

### Position

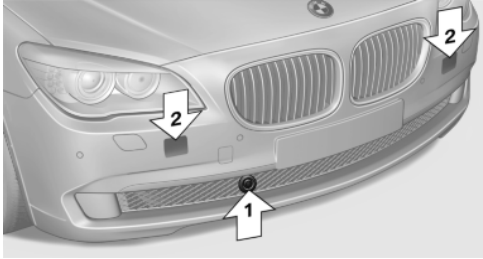

- ▷ Long distance sensor, arrow 1.
- ▷ Field of view of short distance sensors behind the bumper, arrow 2.

### Dirty or covered sensor

A dirty or covered sensor may hinder the detection of vehicles.

- ▷ If necessary, clean the radar sensor and the bumper in front of the short distance sensors. Remove layers of snow and ice carefully.
- ▷ Do not cover the view field of the short distance sensors, e.g., with stickers or similar objects.

### Malfunction

The system cannot be activated if the sensor is not aligned correctly. This may be caused by damage incurred during parking, for example.

A message is displayed if the system fails.

### For US owners only

The transmitter and receiver units comply with part 15 of the FCC/Federal Communication Commission regulations. Operation is governed by the following:

FCC ID:

- ▷ NF3 ACC2SCU 003YK04001 0000

Compliance statement:

This device complies with part 15 of the FCC Rules. Operation is subject to the following two conditions:

- ▷ This device may not cause harmful interference, and
- ▷ this device must accept any interference received, including interference that may cause undesired operation.

Any unauthorized modifications or changes to these devices could void the user's authority to operate this equipment.

## Collision warning\*

### The concept

The system issues a two-phase warning of a danger of collision at speeds above approx. 10 mph/15 km/h.

The collision warning is available even if cruise control has been deactivated.

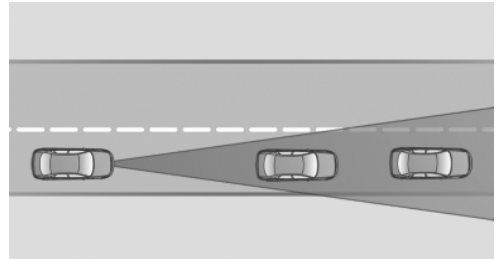

It responds to moving objects that are within the detection range of the radar system.

### Warning stages

#### Prewarning

This warning is issued, for example, when there is an impending danger of a collision or the distance to the vehicle ahead is too small.

#### Acute warning

This warning is issued when there is an immediate danger of a collision because your vehicle is approaching a slow moving vehicle at a rela-



tively high speed, the so-called differential speed.

## Switching the warning function on/off



Press the button

- ▷ On: the LED lights up.
- ▷ Off: the LED goes out.

The state is stored for the remote control currently in use.

## Configuring the prewarning

After the warning function is switched on, the following can be set via the iDrive:

- ▷ The prewarning can be switched on/off.
- ▷ The time of the prewarning can be set.

These settings have no effect on the time of the warning from the Active Cruise Control\* that prompts the driver to intervene or brake.

## Display

The collision warning can be issued in the instrument cluster, in the Head-up Display\* and acoustically.

## Instrument cluster



The vehicle lights up in red: prewarning



The vehicle flashes red and an acoustic signal sounds: acute warning

You are requested to intervene by braking or making an evasive maneuver.



Adapting your speed and driving style

The display does not relieve the driver of the responsibility to adapt his or her desired driving speed and style to the traffic conditions. ◀

## System limits

### Detection range

The detection capacity of the radar sensor and the collision warning has limitations.

This may result in the warning not being issued or being issued late.

For example, the following situations may not be detected:

- ▷ Slow moving objects when you approach them at high speed.
- ▷ Vehicles that suddenly swerve in front of your vehicle.
- ▷ Two-wheeled vehicles ahead of you.
- ▷ Pedestrians.

The system may not be fully functional in the following situations:

- ▷ In heavy fog, rain or snowfall.
- ▷ In tight curves.
- ▷ If the radar sensor is dirty.



Be alert

Due to system limitations, warnings may be not be issued at all, or may be issued late or improperly. Therefore, always be alert and ready to intervene; otherwise, there is the danger of an accident occurring. ◀

### Prewarning sensitivity

If the prewarning sensitivity is high, a larger number of false warnings may occur.

## Cruise control

### The concept

The system is functional at speeds beginning at approx. 20 mph/30 km/h.

It maintains the speed that was set using the control elements on the steering wheel.

The system brakes on downhill gradients if engine braking action is insufficient.



Unfavorable conditions

Do not use the system if unfavorable conditions make it impossible to drive at a constant speed, for instance:

- ▷ On curvy roads.
- ▷ In heavy traffic.
- ▷ On slippery roads, in fog, snow or rain, or on a loose road surface.

Otherwise, you could lose control of the vehicle and cause an accident. ◀

## Controls

### Buttons at a glance

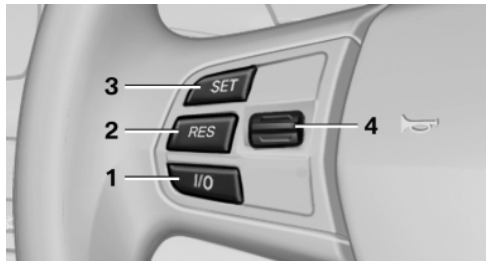

- 1 System on/off, interrupt
- 2 Resume speed
- 3 Store speed
- 4 Change/maintain speed

### Switching on



Press the button on the steering wheel.

The marking in the speedometer is set to the current speed.

Cruise control can be used.

When cruise control is activated, there may be a program change in the [Dynamic Driving Control](#), refer to page 103.

### Switching off



Deactivated or interrupted system

If the system is deactivated or interrupted, actively intervene by braking and, if necessary, with evasive maneuvers; otherwise, there is the danger of an accident occurring. ◀



Press the button.

- ▷ If active: press twice.
- ▷ If interrupted: press once.

The displays go out. The stored desired speed is deleted.

### Interrupting



When active, press the button.

The system is automatically interrupted if:

- ▷ The brakes are applied.
- ▷ Transmission position D is disengaged.
- ▷ DTC Dynamic Traction Control is activated or DSC is deactivated.
- ▷ DSC is actively controlling stability.

### Maintaining/storing the current speed



Press the button.

When the system is switched on, the current speed is maintained and stored as the desired speed.

It is displayed in the speedometer and briefly displayed in the instrument cluster, [Displays in the speedometer](#), refer to page 115.

### Changing the speed



Adapting the desired speed

Adapt the desired speed to the road conditions and be ready to brake at all times; otherwise, there is the danger of an accident occurring. ◀

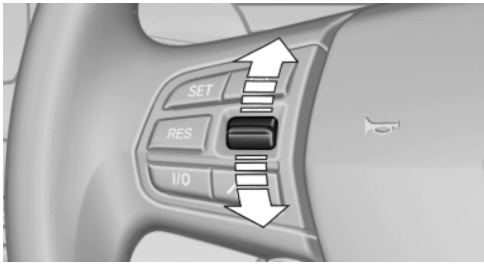

Press the rocker switch up or down repeatedly until the desired speed is set, regardless of whether the system is currently active or has been interrupted.

If active, the displayed speed is stored and the vehicle reaches the stored speed if the road is clear.

- ▷ Each time the rocker switch is pressed to the point of resistance, the desired speed increases or decreases by approx. 1 mph/ 1 km/h.
- ▷ Each time the rocker switch is pressed past the point of resistance, the desired speed increases or decreases by a maximum of 5 mph/10 km/h.

Hold the rocker switch in position to repeat the action.

The rocker switch can be pressed while interrupted to maintain and store the current speed.

### Desired speed



Press the button.

The stored speed is reached and maintained.

## Displays in the instrument cluster

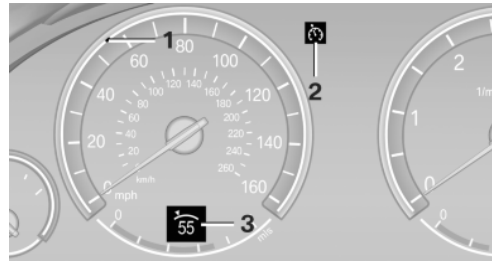

- 1 Display of desired speed
- 2 Indicator lamp
- 3 Brief status display

### Desired speed

Display in the speedometer:

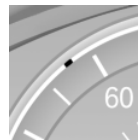

- ▷ The marking lights up in green: the system is active.
- ▷ The marking lights up in orange: the system has been interrupted.

- ▷ The marking does not light up: the system is switched off.

Brief display in the speedometer:



Selected desired speed

If --- appears briefly, conditions may not be adequate to operate the system.

## PDC Park Distance Control\*

### The concept

In addition to the PDC Park Distance Control, the [backup camera\\*](#), refer to [page 118](#), can be switched on.

PDC supports you when parking. Objects that you are approaching slowly in front of or behind your vehicle are indicated with:

- ▷ Signal tones.
- ▷ Visual display.

## Measurement

Measurements are made by ultrasound sensors in the bumpers.

The range is approx. 6 ft/2 m.

An acoustic warning is first given:

- ▷ By the front\* sensors and two rear corner sensors at approx. 24 in/60 cm.
- ▷ By the rear middle sensors at approx. 5 ft/1.50 m.

## System limits



Check the traffic situation as well

PDC cannot serve as a substitute for the driver's personal judgment of the traffic situation. Check the traffic situation around the vehicle with your own eyes. Otherwise, an accident could result from road users or objects located outside of the PDC detection range.

Loud noises from outside and inside the vehicle may prevent you from hearing the PDC's signal tone. ◀



Avoid driving quickly with PDC

Avoid approaching an object quickly.

Avoid driving away quickly while PDC is not yet active.

Otherwise, the system may be too late in issuing a warning for technical reasons. ◀

## Limits of ultrasonic measurement

The detection of objects can reach the physical limits of ultrasonic measurement, for instance:

- ▷ With tow bars and trailer hitches.
- ▷ With thin or wedge-shaped objects.
- ▷ With low objects.
- ▷ With objects with corners and sharp edges.

Low objects already displayed, e.g., curbs, can move into the blind area of the sensors before or after a continuous tone sounds.

High, protruding objects such as ledges may not be detected.

## False warnings

PDC may issue a warning under the following conditions even though there is no obstacle within the detection range:

- ▷ In heavy rain.
- ▷ When sensors are very dirty or covered in ice.
- ▷ When sensors are covered in snow.
- ▷ On rough road surfaces.
- ▷ In large buildings with right angles and smooth walls, e.g., in underground garages.
- ▷ In heavy exhaust.
- ▷ Due to other ultrasound sources, e.g., sweeping machines, high pressure steam cleaners or neon lights.

## Switching on automatically

Engage transmission position R with the engine running or the ignition switched on.

## Switching off automatically

The system switches off and the LED goes out:

- ▷ After approx. 160 ft/50 m when driving forward.
- ▷ Above approx. 22 mph/36 km/h when driving forward.

Switch on the system again if necessary.

## Switching on/off manually



Press the button.

- ▷ On: the LED lights up.
- ▷ Off: the LED goes out.

## Signal tones

When approaching an object, an intermittent tone is sounded that indicates the position of the object. For example, if an object is detected to the left rear of the vehicle, a signal tone sounds from the left rear speaker.

The shorter the distance to the object becomes, the shorter the intervals.

If the distance to a detected object is less than approx. 12 in/30 cm, a continuous tone is sounded.

If objects are located both in front of and behind the vehicle, an alternating continuous signal is sounded.

The intermittent tone is interrupted after approx. 3 seconds:

- ▷ If the vehicle stops in front of an object that is detected by only one of the corner sensors.
- ▷ If moving parallel to a wall.

The signal tone is switched off:

- ▷ When the vehicle moves away from an object by more than approx. 4 in/10 cm.
- ▷ When transmission position P is engaged.

## Volume

You can set the [volume of the PDC signal tone, refer to page 171](#).

The setting is stored for the remote control currently in use.

## Visual warning

The approach of the vehicle to an object can be shown on the Control Display. Objects that are farther away are displayed on the Control Display before a signal tone sounds.

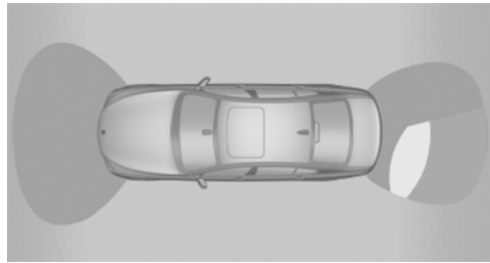

The display appears as soon as PDC is activated.

If the backup camera image was selected last, it again appears on the display. To switch to PDC:

1.  "Switch off rear view camera" Select the symbol on the Control Display.
2. Press the controller.

The setting is stored for the remote control currently in use.

## Display on the Control Display

### Switching on the backup camera via the iDrive

With PDC activated:

1.  "Switch on rear view camera" Select the symbol.
2. Press the controller.

The backup camera image is displayed. The setting is stored for the remote control currently in use.

## Malfunction

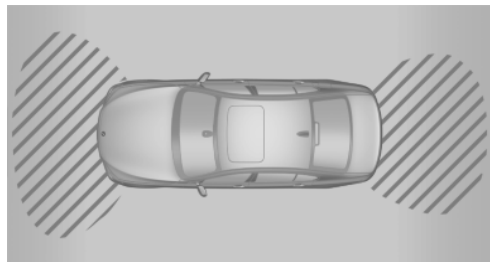

A [Check Control message, refer to page 83](#), is displayed in the instrument cluster.

On the Control Display, the areas in front of and behind the vehicle are shaded. PDC has failed. Have the system checked.

To ensure full operability:

- ▷ Keep the sensors clean and free of ice.
- ▷ When using high-pressure washers, do not spray the sensors for long periods and maintain a distance of at least 12 in/30 cm.

## Backup camera\*

### The concept

The backup camera provides assistance in parking and maneuvering backwards. The area behind the vehicle is shown on the Control Display.

### System limits

 Check the traffic situation as well  
 Check the traffic situation around the vehicle with your own eyes. Otherwise, an accident could result from road users or objects located outside the picture area of the backup camera. ◀

 Detection of objects  
 High, protruding objects such as ledges may not be detected by the backup camera. ◀

### Switching on automatically

Engage transmission position R with the engine running or the ignition switched on.

The backup camera image is displayed if the system was switched on via the iDrive.

### Switching off automatically

The system switches off and the LED goes out:

- ▷ After approx. 33 ft/10 m when driving forward.
- ▷ After approx. 9 mph/15 km/h when driving forward.

Switch on the system again if necessary.

## Switching on/off manually



 Press the button.

- ▷ On: the LED lights up.
- ▷ Off: the LED goes out.

If PDC is displayed, switch on the [backup camera](#) via the iDrive, refer to page 119.

## Assistance functions

### Functional requirement

- ▷ The backup camera is switched on.
- ▷ The trunk lid is fully closed.

### Pathway lines

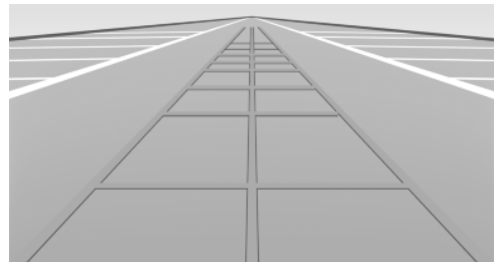

- ▷ Can be shown in the backup camera image when in transmission position R.
- ▷ Help you to estimate the space required when parking and maneuvering on level roads.
- ▷ Are dependent on the current steering angle and are continuously adjusted to the steering wheel movements.

Show the parking aid lines via the iDrive, refer to page 119.

## Turning circle lines

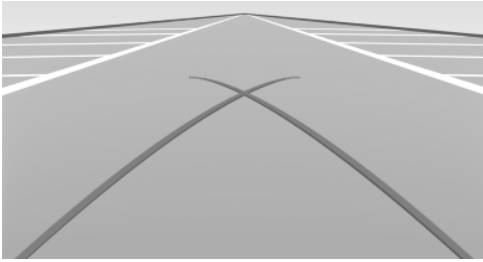

- ▷ Can be shown in the backup camera image.
- ▷ Show the course of the smallest possible turning circle on a level road.
- ▷ Only one turning circle line is displayed when the steering wheel is turned.

Show the parking aid lines via the iDrive, refer to page 119.

## Parking using pathway and turning circle lines

1. Position the vehicle so that the turning circle lines lead to within the limits of the parking space.

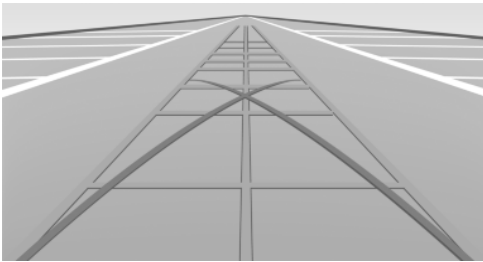

2. Turn the steering wheel to the point where the pathway line covers the corresponding turning circle line.

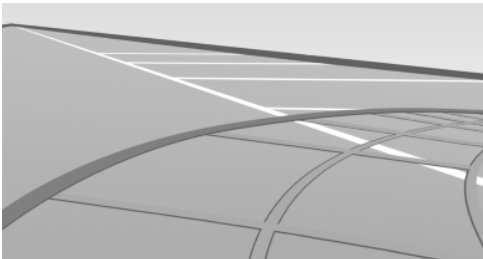

## Obstacle marking

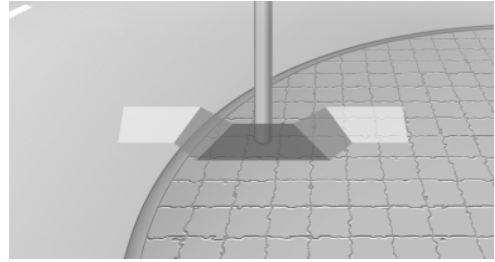

- ▷ Spatially-shaped markings can be shown in the backup camera image.

Their colored steps match the markings of the PDC. This simplifies estimation of the distance to the object shown.

## Activating the assistance functions

More than one assistance function can be active at the same time.

### Showing the parking aid lines

1.  "Parking aid lines" Select the symbol.
2. Press the controller.

Pathway and turning circle lines are displayed.

### Showing the obstacle marking

1.  "Display obstacle marking" Select the symbol.
2. Press the controller.

Spatially-shaped markings are displayed.

## Display on the Control Display

### Switching on the backup camera via the iDrive

With PDC activated:

1.  "Switch on rear view camera" Select the symbol.
2. Press the controller.

The backup camera image is displayed. The setting is stored for the remote control currently in use.

## Brightness

With the backup camera switched on:

1. ☀ Select the symbol.
2. Turn the controller until the desired setting is reached and press the controller.

## Contrast

With the backup camera switched on:

1. ● Select the symbol.
2. Turn the controller until the desired setting is reached and press the controller.

## Camera



The camera lens is located in the handle of the trunk lid. The image quality may be impaired by dirt.

Clean the lens, refer to page 252.

## Side View\*

### The concept

Side View provides an early look at cross traffic at blind driveways and intersections. Road users concealed by obstacles to the left and right of the vehicle can only be detected relatively late from the driver's seat. To improve visibility, two cameras in the front of the vehicle record the traffic situation on each side.

### System limits

The cameras capture a maximum range of 330 ft/100 m.

## Display

The images from both cameras are shown simultaneously on the Control Display.



Check the traffic situation as well

Check the traffic situation around the vehicle on blind driveways and intersections with your own eyes. Otherwise, an accident could result from road users or objects located outside the picture area of the Side View cameras. ◀

### Switching off automatically

System switches off: above approx. 9 mph / 15 km/h.

Switch on the system again if necessary.

### Switching on/off manually



Press the button.

### Display on the Control Display

The traffic area to the left and right is displayed on the Control Display.

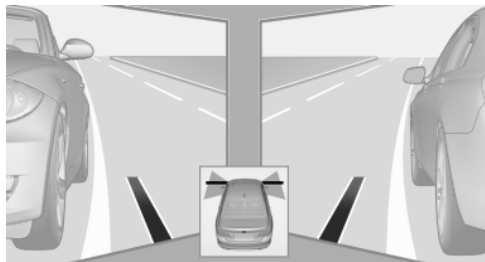

Guidelines at the bottom of the image show the position of the front of the vehicle.



## Brightness

With the Side View switched on:

1. ☀ Select the symbol.
2. Turn the controller until the desired setting is reached and press the controller.

## Contrast

With the Side View switched on:

1. ● Select the symbol.
2. Turn the controller until the desired setting is reached and press the controller.

## Cameras

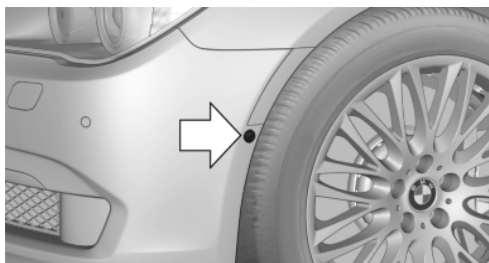

The two camera lenses are located on the sides of the bumper.

The image quality may be impaired by dirt.

[Clean the lens, refer to page 252.](#)

## Night Vision with pedestrian detection\*

### The concept

Night Vision with pedestrian detection is a night vision system.

An infrared camera records the area in front of the vehicle and displays the image on the Control Display.

The picture is a heat image. The system has an integrated pedestrian detection function that detects pedestrians and cyclists. Warm objects that are similar in shape to human beings are detected by the system.



### Personal responsibility

Night Vision cannot replace the driver's personal judgment of the visibility conditions and the traffic situation. The view ahead and the actual visibility conditions must always be the basis on which the vehicle speed is adjusted; otherwise, there is a risk to road safety. ◀

## Heat image



The image shows the heat radiated by objects in the field of view of the camera.

Warm objects have a light appearance and cold objects, a dark appearance.

The ability to detect an object depends on the temperature difference between the object and the background and on the level of heat radiation emitted by the object. Objects that are similar in temperature to the environment or that radiate very little heat are difficult to detect.

## Pedestrian detection



Warm objects that are similar in shape to human beings are detected by the system.

People detected by the system are displayed with a slight yellow hue.

Under good ambient conditions, the pedestrian detection system operates within a range of approx. 50 ft/15 m to approx. 330 ft/100 m.

## Warning of people in danger



If the system detects a person in a defined area in front of the vehicle and if a collision with this person is imminent, a warning symbol appears in the Control Display and Head-up Display\*.

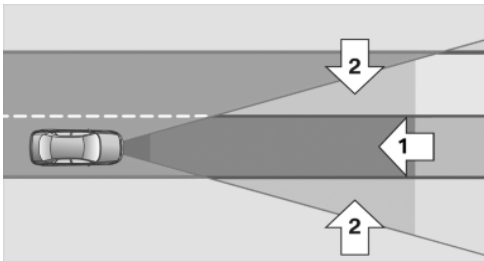

The warning area in front of the vehicle is divided into two areas.

- ▷ Central area 1 directly in front of the vehicle.
- ▷ Expanded area 2 to the right and left.

The entire area moves along with the vehicle in the direction of the steering angle and changes with the vehicle speed. As the vehicle speed increases, the area becomes longer and wider, for example.



This symbol is displayed when a person is detected in the central area, arrow 1, immediately in front of the vehicle.



This symbol is displayed when a person detected in the extended area, arrow 2, is moving from the right or left to the central area.

The symbols in the Head-up Display\* correspond to the symbols in the Control Display. For people located in the central area, the distance to the person is indicated by the size of the symbol.

Although both the shape and the heat radiation are analyzed, false warnings cannot be ruled out.

## System limits

Animals are not detected by the pedestrian detection function, even if they are clearly visible in the image.

System operation is limited in situations such as the following:

- ▷ On steep hills, in steep depressions or in tight curves.
- ▷ When the camera is dirty or the protective glass is damaged.
- ▷ In heavy fog, rain or snowfall.
- ▷ At very high external temperatures.

## Pedestrian detection

Limited pedestrian detection:

- ▷ When people are fully or partially covered, especially when their heads are covered.
- ▷ When people are not in an upright position, e.g., when lying down.
- ▷ Cyclists on unconventional bicycles (e.g., recumbent bicycles).
- ▷ After physical damage to the system, e.g., after an accident.

## Activation/deactivation



 Press the button.

## Display

### Heat image

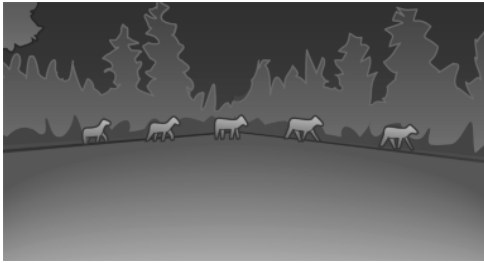

For safety reasons, when driving at speeds above approx. 3 mph/5 km/h and in low ambient light, the image is only displayed when the low beams are switched on.

A still image is displayed at regular intervals for a fraction of a second.

Night Vision with pedestrian detection is not available on the rear screen.

### Pedestrian detection



Environmental influences can limit the availability of pedestrian detection. If pedestrian detection is not available, a symbol is displayed in the heat image.

This symbol disappears when the function becomes available again.

The pedestrian detection and warning function only operates while the heat image is being displayed.

### Adjustments via the iDrive

With Night Vision switched on:

1. Activate Night Vision with pedestrian detection.
2. Press the controller.
3. Open the desired menu item.
  - ▷ "Brightness"
  - ▷ "Contrast"
  - ▷ "Pedestrian detection"



The settings are stored for the remote control currently in use.

### Camera

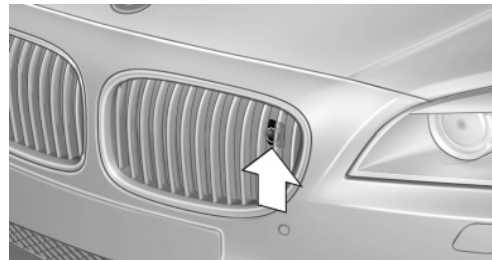

Rain, dirt, snow, or ice can impair camera operation.

The camera is automatically heated when the external temperatures are low.

The camera is automatically cleaned together with the headlamps.

[Clean the lens, refer to page 252.](#)

## Head-up Display\*

### The concept

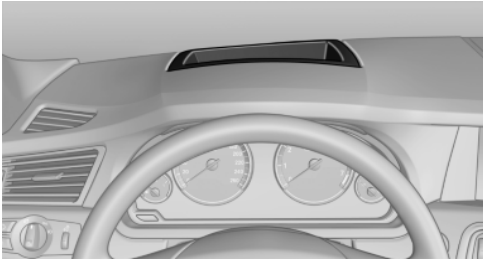

This system projects important information into the driver's field of vision, e.g., the speed.

In this way, the driver can get information without averting his or her eyes from the road.

### Display visibility

The visibility of the displays in the Head-up Display is influenced by:

- ▷ Certain sitting positions.
- ▷ Objects on the cover of the Head-up Display.
- ▷ Sunglasses with certain polarization filters.
- ▷ Wet roads.
- ▷ Unfavorable light conditions.

If the image is distorted, check the basic settings.

### Switching on/off



Press the button.

## Display

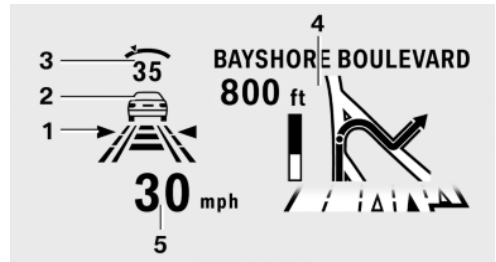

- 1 Lane departure warning\*
- 2 Active Cruise Control\*
- 3 Desired speed\*
- 4 Navigation system\*
- 5 Speed

The collision warning\* or Check Control messages are displayed briefly if needed.

### Selecting displays in the Head-up Display

1. "Settings"
2. "Head-Up display"
3. "Displayed information"
4. Select the desired displays in the Head-up Display.

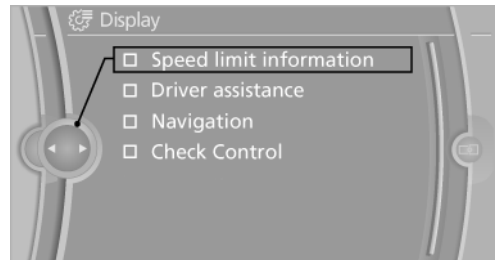

The settings are stored for the remote control currently in use.

### Setting the brightness

The brightness is automatically adjusted to the ambient light.

The basic setting can be adjusted manually.

1. "Settings"
2. "Head-Up display"

3. "Brightness"
4. Turn the controller.

The brightness is adjusted.

When the low beams are switched on, the basic setting can be made using the [instrument lighting, refer to page 88](#).

The setting is stored for the remote control currently in use.

### Adjusting the height

1. "Settings"
2. "Head-Up display"
3. "Height"
4. Turn the controller.

The height is adjusted.

The setting is stored for the remote control currently in use.

### Special windshield

The windshield is part of the system.

The shape of the windshield makes it possible to display a precise image.

A film in the windshield prevents double images from being displayed.

Therefore, have the windshield replaced by a service center only.

# Climate control

## Automatic climate control\*

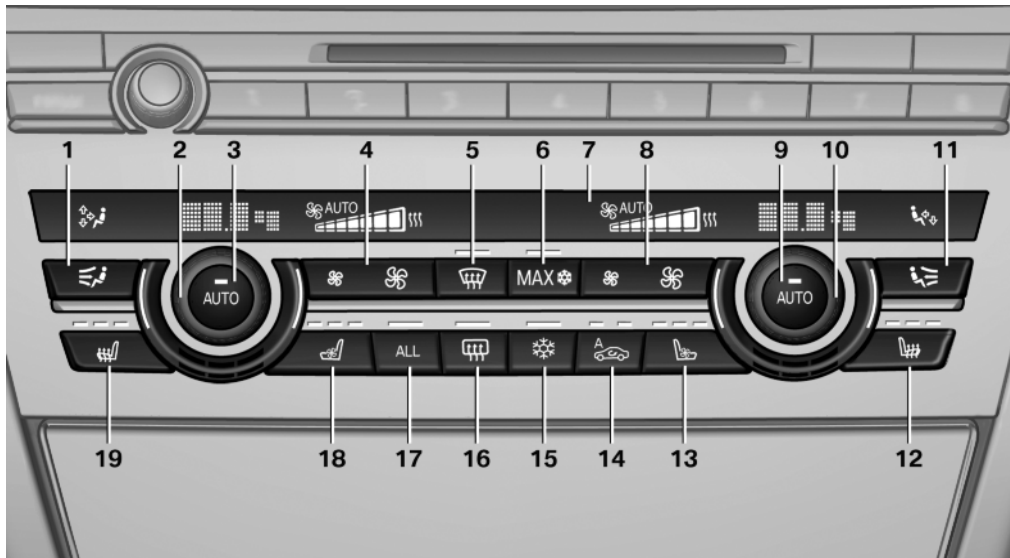

- |  |   |
|--|---|
| 1 Air distribution, left side                          | 11 Air distribution, right side                             |
| 2 Temperature, left side                               | 12 <a href="#">Seat heating*</a> , right side 49            |
| 3 AUTO program, left side                              | 13 <a href="#">Active seat ventilation*</a> , right side 49 |
| 4 Air volume, AUTO intensity, residual heat, left side | 14 Automatic recirculated-air control/recirculated-air mode |
| 5 Remove ice and condensation                          | 15 Cooling function   |
| 6 Maximum cooling                                      | 16 Rear window defroster                                    |
| 7 Display  | 17 ALL program  |
| 8 Air volume, AUTO intensity, right side               | 18 <a href="#">Active seat ventilation*</a> , left side 49  |
| 9 AUTO program, right side                             | 19 <a href="#">Seat heating*</a> , left side 49             |
| 10 Temperature, right side                             |   |

## Climate control functions in detail

### Manual air distribution

 Press the button repeatedly to select a program:

- ▷ Upper body region.
- ▷ Upper body region and footwell.

- ▷ Footwell.
- ▷ Windows and footwell: driver's side only.
- ▷ Windows, upper body region and footwell: driver's side only.

If the windows are fogged over, press the AUTO button on the driver's side to utilize the condensation sensor.

## Temperature



Turn the wheel to set the desired temperature.

The automatic climate control achieves this temperature as quickly as possible, if necessary with the maximum cooling or heating capacity, and then keeps it constant.

Avoid rapidly switching between different temperature settings. The automatic climate control will not have sufficient time to adjust the set temperature.

## AUTO program



Press the button.

Air volume, air distribution, and temperature are controlled automatically.

Depending on the selected temperature, AUTO intensity, and outside influences, the air is directed to the windshield, side windows, upper body, and into the footwell.

The **cooling function**, refer to page 128, is switched on automatically with the AUTO program.

At the same time, a condensation sensor controls the program so as to prevent window condensation as much as possible.

## Intensity of the AUTO program

With the AUTO program switched on, automatic control of the air volume and air distribution can be adjusted.



Press the left or right side of the button: decrease or increase the intensity.

The selected intensity is shown on the display of the automatic climate control.

## Air volume, manual

To be able to manually adjust the air volume, switch off the AUTO program first.



Press the left or right side of the button: decrease or increase air volume.

The selected air volume is shown on the display of the automatic climate control.

## Defrosting windows and removing condensation



Press the button.

Ice and condensation are quickly removed from the windshield and the front side windows.

The air volume can be adjusted when the program is active.

## Maximum cooling



Press the button.

The system is set to the lowest temperature, maximum air volume and recirculated-air mode.

Air flows out of the vent outlets for the upper body region. Open them for this purpose.

Air is cooled as quickly as possible:

- ▶ At an external temperature of approx. 32 °F/ 0 °C.
- ▶ When the engine is running.

The air volume can be adjusted when the program is active.

## Automatic recirculated-air control/ recirculated-air mode

You can respond to unpleasant odors or pollutants in the immediate environment by temporarily suspending the supply of outside air. The system then recirculates the air currently within the vehicle.



Press the button repeatedly to select an operating mode:

- ▶ LEDs off: outside air flows in continuously.
- ▶ Left LED on, automatic recirculated-air control: a sensor detects pollutants in the outside air and controls the shut-off automatically.
- ▶ Right LED on, recirculated-air mode: the supply of outside air into the vehicle is permanently blocked.

If the windows are fogged over, switch off the recirculated-air mode and press the AUTO button on the driver's side to utilize the condensation sensor. Make sure that air can flow onto the windshield.



Continuous recirculated-air mode

The recirculated-air mode should not be used for an extended period of time, as the air quality inside the vehicle deteriorates steadily. ◀

## Cooling function

The passenger compartment can only be cooled with the engine running.



Press the button.

The air is cooled and dehumidified and – depending on the temperature setting – warmed again.

Depending on the weather, the windshield may fog up briefly when the engine is started.

The cooling function is switched on automatically with the AUTO program.

When using the automatic climate control, [condensation water](#), refer to page 148, develops that exits underneath the vehicle.

## Rear window defroster



Press the button.

The rear window defroster switches off automatically after a certain period of time.

## All program



Press the button.

The current settings on the driver's side for temperature, air volume, air distribution, and AUTO program are transferred to the front passenger side and to the left and right rear\*.

The program is switched off if the settings on the front passenger side and in the rear\* are changed.

## Residual heat

The heat stored in the engine is used to heat the interior.

## Functional requirement

- ▷ Up to 20 minutes after switching off the engine.
- ▷ Warm engine.
- ▷ The battery is sufficiently charged.
- ▷ External temperature below 77 °F/25 °C.

## Switching on

1. Switch off the ignition.



2. Press the right side of the button on the driver's side.

⏏ is shown in the display of the automatic climate control.

The interior temperature, air volume and air distribution can be adjusted with the ignition switched on.

## Switching off

At the lowest fan speed, press the left side of the button on the driver's side.

⏏ on the display of the automatic climate control goes out.

## Switching the system on/off

### Switching off

- ▷ Complete system:



At the lowest fan speed, press the left side of the button on the driver's side.

- ▷ On the front passenger side:



At the lowest fan speed, press the left side of the button on the front passenger side.

### Switching on

Press any button.

## Microfilter/activated-charcoal filter

The microfilter removes dust and pollen from the incoming air.



The activated-charcoal filter removes gaseous pollutants from the outside air that enters the vehicle.

This combined filter should be replaced during scheduled maintenance of your vehicle.

More information can be found in the [service requirements display](#), refer to [page 82](#).

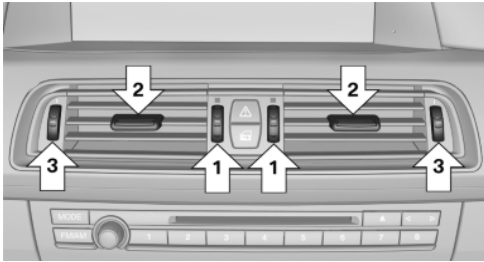

## Ventilation

### Front ventilation



- ▷ Thumb wheels for adjusting the temperature, arrows 1.  
Toward blue: colder.  
Toward red: warmer.
- ▷ Lever for changing the air flow direction, arrow 2.
- ▷ Thumb wheels for opening and closing the vents continuously, arrows 3.

### Ventilation levels\*

- ▷ Draft-free ventilation:  
Thumb wheel, arrow 3, in level  : the air current is fanned out.
- ▷ Maximum air volume:  
Thumb wheel, arrow 3, in level  : the air is partially fanned out and partially bundled. This maximizes the air supply.
- ▷ Direct ventilation:  
Thumb wheel, arrow 3, in level  : the air is bundled and can be directed to a specific point.

## Adjusting the ventilation

- ▷ Ventilation for cooling:  
Adjust the vent to direct the air in your direction, e.g., if the vehicle interior is hot from the sun.
- ▷ Draft-free ventilation:  
Adjust the vent to let the air flow past you.

### Ventilation in rear, center

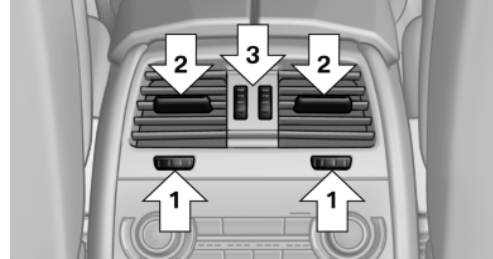

- ▷ Thumb wheels\* for adjusting the temperature, arrows 1.  
Toward blue: colder.  
Toward red: warmer.
- ▷ Lever for changing the air flow direction, arrow 2.
- ▷ Thumb wheels for opening and closing the vents continuously, arrows 3.

### Lateral ventilation\*

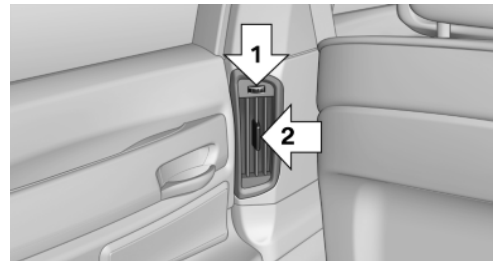

- ▷ Thumb wheel for opening and closing the vents continuously, arrow 1.
- ▷ Lever for changing the air flow direction, arrow 2.

## Rear automatic climate control\*

### At a glance

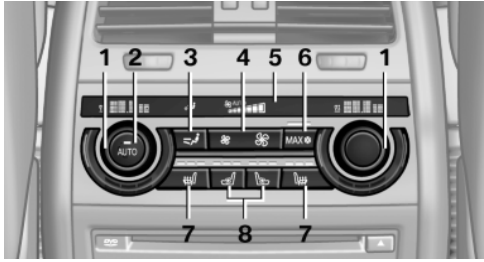

- 1 Temperature
- 2 AUTO program
- 3 Vent settings
- 4 Air volume, AUTO intensity
- 5 Display
- 6 Maximum cooling
- 7 [Seat heating\\* 51](#)
- 8 [Active seat ventilation\\* 52](#)

### Switching the rear automatic climate control on/off

1. "Settings"
2. "Climate"
3. "Rear climate control"

The rear automatic climate control is not operational if the automatic climate control is switched off or if the function for defrosting or defogging the windows is active.

### AUTO program



Press the button.

Air volume, air distribution, and temperature are controlled automatically:

Depending on the selected temperature, AUTO intensity, and outside influences, the air is directed to the upper body and into the footwell.

The cooling function is switched on automatically with the AUTO program.

### Intensity of the AUTO program

With the AUTO program switched on, automatic control of the air volume and air distribution can be adjusted.



Press the left or right side of the button: decrease or increase the intensity.

The selected intensity is shown on the display of the automatic climate control.

### Temperature



Turn the wheel to set the desired temperature.

The automatic climate control achieves this temperature as quickly as possible, if necessary with the maximum cooling or heating capacity, and then keeps it constant.

Avoid rapidly switching between different temperature settings. The automatic climate control will not have sufficient time to adjust the set temperature.

### Manual air distribution

The air distribution can be adjusted to individual needs.



Press the button repeatedly to select a program:

- ▷ Upper body region.
- ▷ Upper body region and footwell.
- ▷ Footwell.

### Air volume, manual

To be able to manually adjust the air volume, switch off the AUTO program first.



Press the left or right side of the button: decrease or increase air volume.

The selected air volume is shown on the display of the automatic climate control.

## Switching the system on/off

### Switching off



At the lowest fan speed, press the left side of the button on the driver's side.

### Switching on

Press any button.

### Maximum cooling



Press the button.

The system is set to the lowest temperature, maximum air volume and recirculated-air mode.

Air flows out of the vent outlets for the upper body region. Open them for this purpose.

Air is cooled as quickly as possible:

- ▷ At an external temperature of approx. 32 °F/ 0 °C.
- ▷ When the engine is running.

## Climate control operation on the headliner\*

### Temperature



Turn the wheel to set the desired temperature.

### Air volume



Press the left or right side of the button: decrease or increase air volume.

LEDs indicate the intensity of the air supply.

## Ventilation

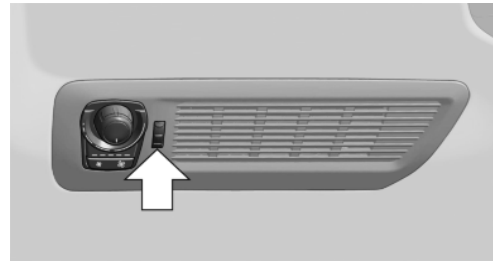

Thumb wheel for changing the air flow direction, arrow.

## Parked-car ventilation

### The concept

The parked-car ventilation ventilates the vehicle interior and lowers its temperature, if necessary. The system can be switched on and off directly or by using two preset switch-on times. It remains switched on for 30 minutes.

Operation takes place on the iDrive.



### Parked-car ventilation

- ▷ Using the preset switch-on time: External temperature above approx. 59 °F/15 °C.
- ▷ Direct operation: Any external temperature. Open the vents to allow air to flow out.

### Switching on/off directly

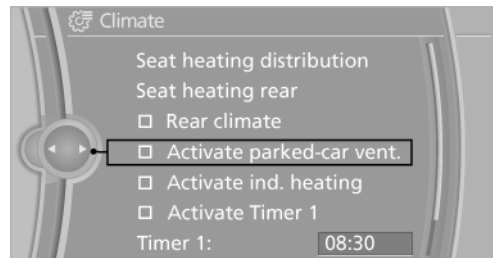
1. "Settings"
2. "Climate"
3. "Activate parked-car vent."



 The system is switched on.  The symbol on the automatic climate control flashes.



The system continues to run for some time after being switched off.

## Preselecting the switch-on time

1. "Settings"
2. "Climate"
3. "Timer 1:" or "Timer 2:"
4. Enter the desired time.
5. Press the controller to adopt the setting.

## Activating the switch-on time

1. "Settings"
2. "Climate"
3. "Activate Timer 1" or "Activate Timer 2"

 The activation time is activated.  The symbol on the automatic climate control lights up.

 The symbol on the automatic climate control flashes when the system has been switched on.

The system will only be switched on within the next 24 hours. After that, it needs to be reactivated.

# Interior equipment

## Integrated universal remote control\*

### The concept

This system can replace up to three different hand-held transmitters for various types of remote-controlled equipment, such as garage doors or lighting systems.

The hand-held transmitter signal can be programmed on one of the three memory buttons.

The corresponding device can then be operated using the programmed memory button.

The LED indicates that a signal is being transmitted.

When selling the vehicle, delete the stored programs for security reasons.



During programming

During programming and before activating a device using the universal remote control, ensure that there are no people, animals, or objects in the range of movement of the remote-controlled device; otherwise, there is a risk of injury or damage.

Also follow the safety instructions of the hand-held transmitter. ◀

### Compatibility



If this symbol is printed on the packaging or in the instructions of the hand-held transmitter, the remote-controlled device is generally compatible with the universal remote control.

If you have any questions, please contact:

- ▷ Service.
- ▷ 1-800-355-3515.
- ▷ [www.homelink.com](http://www.homelink.com) on the Internet.

## Programming

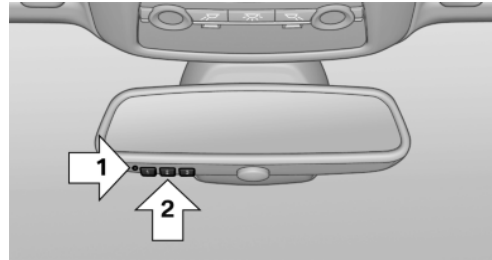

- ▷ LED, arrow 1.
- ▷ Memory buttons, arrow 2.

## Fixed-code hand-held transmitters

1. Switch on the ignition.
2. Initial setup:  
Press both outer buttons 1 and 3 for approx. 20 seconds until the LED flashes.  
All programs of the three memory buttons, arrow 2, are cleared.
3. Hold the hand-held transmitter at a distance of approx. 2 to 8 in/5 to 20 cm from the memory buttons.
4. Simultaneously press the transmit button of the hand-held transmitter and the memory button of the universal remote control.  
The LED flashes slowly.
5. Release both buttons when the LED flashes rapidly.  
If the LED does not flash rapidly after approx. 15 seconds, change the distance and repeat the step.

The device can be operated using the memory button with the engine running or the ignition switched on.

## Malfunction

If the device cannot be used after repeated attempts at programming, please check whether the hand-held transmitter is equipped with an alternating code system.

To do so:

- ▷ Read the instructions of the hand-held transmitter.
- ▷ Press the memory button of the universal remote control for an extended period.

If the LED flashes rapidly for a brief period and then lights up continuously for approx. 2 seconds, the hand-held transmitter is equipped with an alternating code system.

In this case, program the memory buttons as described under Alternating-code hand-held transmitter.

### Alternating-code hand-held transmitters

Please obtain information on synchronizing the device in the operating manual of the device being set up.

Programming will be easier with the aid of a second person.

1. Park the vehicle within range of the remote-controlled device.
2. Program the universal remote control as described above under Fixed-code hand-held transmitters.
3. Press and hold the programmed button on the interior rearview mirror for approx. 5 seconds until the device to be adjusted is activated.

If the device does not become activated, press and hold the button and watch the LED:

- ▷ If the LED lights up continuously, the programming is completed. The device should become activated when the button is pressed briefly.
  - ▷ If the LED flashes for approx. 2 seconds and then lights up continuously, continue the programming procedure beginning with step 4.
4. Locate the button on the receiver of the device to be set, e.g., on the drive.

5. Press the button on the receiver of the device to be set. You have approx. 30 seconds for the next step.
6. Press the programmed memory button of the universal remote control three times.

The device can be operated when the engine is running or the ignition is switched on.

### Reassigning individual programs

1. Switch on the ignition.
2. Hold the hand-held transmitter at a distance of approx. 2 to 8 in/5 to 20 cm from the memory buttons.
3. Press the memory button of the universal remote control.
4. If the LED flashes slowly after approx. 20 seconds, press the transmit button on the hand-held transmitter.
5. Release both buttons when the LED flashes rapidly.

If the LED does not flash rapidly after approx. 15 seconds, change the distance and repeat the step.

### Deleting all stored programs

Press the left and right memory buttons for approx. 20 seconds until the LED flashes rapidly.

All stored programs are deleted.

The programs cannot be deleted individually.

# Ashtray/cigarette lighter\*

## Front

### Opening



Press on the cover.

### Emptying



Place your finger in the depression next to the ashtray, arrow, and push up at the same time. The ashtray can be removed.

### Lighter



Push in the lighter.

The lighter can be removed as soon as it pops back out.



**Danger of burns**

Only hold the hot lighter by its head; otherwise, there is the danger of getting burned. Switch off the ignition and take the remote control with you when leaving the vehicle so that children cannot use the lighter and burn themselves. ◀

## Rear

### Opening

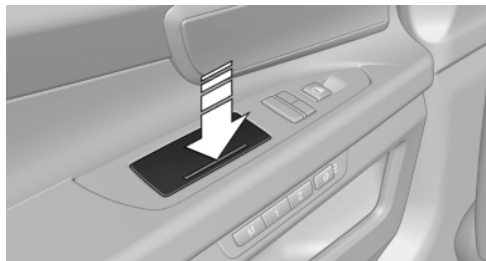

Press the ridge on the cover.

### Emptying

Take out the insert.

### Lighter



Push in the lighter.



**Danger of burns**

Only hold the hot lighter by its head; otherwise, there is the danger of getting burned.

Take the remote control with you when leaving the vehicle so that children cannot use the lighter and burn themselves. ◀

The lighter can be removed as soon as it pops back out.

## Connecting electrical devices

### Sockets

The lighter socket can be used for electrical devices up to approx. 200 watts with 12 volts with the engine running or the ignition switched on.

Do not damage the socket by using unsuitable connectors.

## Front center console

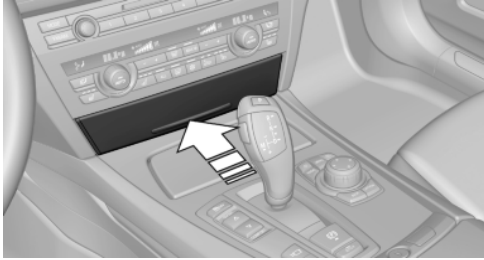

Press on the cover.

Remove the cover or cigarette lighter\*.

## Rear center console



Remove the cover or cigarette lighter\*.

## In the trunk\*

Remove the cover.

## Rear cooler\*

### Behind the center armrest

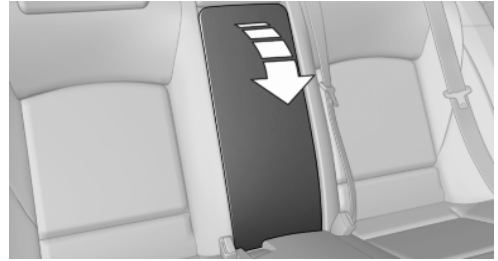

The cooler is located behind the center armrest in the rear.

Fold the center armrest down.

### Switching on

The cooler can be operated at two levels.

1. Switch on the ignition.
2.  Press the button once for each cooling level.

### Switching off

Press the button repeatedly until the LEDs go out.

### Automatic switch-off

When battery voltage becomes low, the cooler is switched off automatically.

The LED flashes steadily.

### Malfunction

The LED flashes irregularly if there is a fault. Have the system checked.



## Opening



Pull on the opener and fold the cooler forward.

## Ski bag\*

### Capacity

The ski bag can be used to transport three pairs of skis with a length of up to 2.10 m or a snowboard with a length of up to 1.60 m.

### Preparing and loading the ski bag

1. Fold open the center arm rest and the lid on the inside.
2. Open the inside cover and trunk by pressing the button.

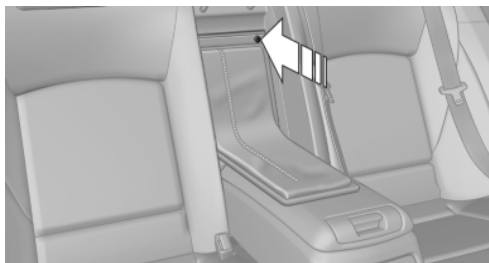

3. Lay out the ski bag.

4. If there is a multifunctional seat in the rear, hook the belt into the fitting using the snap hook.



5. Load the ski bag. If necessary, wrap the sharp edges of the skis.  
If necessary, open the ski bag zipper to ease loading or to dry the ski bag.
6. If there is not a multifunctional seat in the rear, insert the tongue plate into the belt buckle.



7. Tighten the retaining strap.



### Securing the ski bag

Secure the ski bag by tightening the retaining strap; otherwise, the contents could present a source of danger to the passengers, for example during braking or evasive maneuvers. ◀

## Removing the ski bag

The ski bag can be removed entirely, e.g., to dry quickly or to use other inserts.

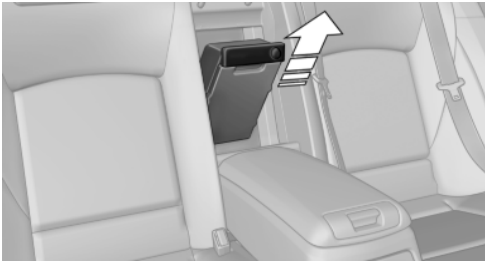

1. Pull the handle forward and lift the ski bag out.
2. Close the cover in the trunk.

More information on the various inserts available can be obtained from your service center.

# Storage compartments

## Storage compartments

The following storage compartments are available in the vehicle interior:

- ▷ Glove compartment on the driver's and front passenger side, refer to page 139.
- ▷ Storage compartment on the center console, refer to page 141.
- ▷ Storage compartment in the center armrest, refer to page 140, in the front and rear.
- ▷ Storage compartment\* between the seats, refer to page 141.
- ▷ Compartments in the doors.
- ▷ Pockets on the backrests of the front seats\*.
- ▷ Net in the front passenger footwell\*.

## Glove compartment

### Front passenger side

#### Opening



Pull the handle.

The light in the glove compartment switches on.

 Close the glove compartment again immediately

Close the glove compartment immediately after use while driving; otherwise, injury may occur during accidents. ◀

#### Closing

Fold up the cover.

#### Opening the top cover

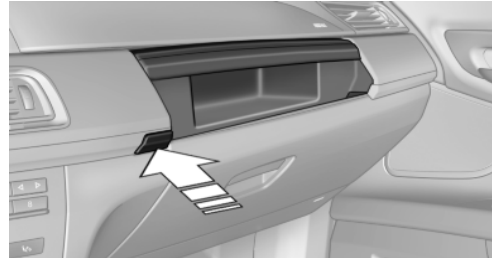

Press the button.

The top cover opens automatically.

#### Closing the top cover

Press the cover closed.

#### USB interface for data transfer

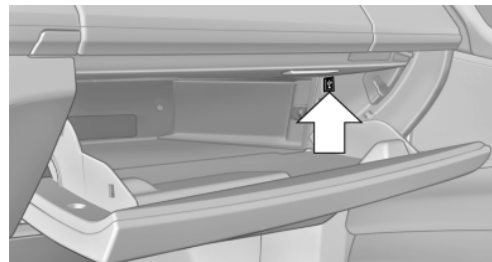

Connection for importing and exporting data on USB devices, e.g.:

- ▷ Personal Profile settings, refer to page 33.
- ▷ Music collection, refer to page 185.

Observe the following when connecting:

- ▷ Do not use force when plugging the connector into the USB interface.
- ▷ Do not connect devices such as fans or lamps to the USB interface.
- ▷ Do not connect USB hard drives.

- ▷ Do not use the USB interface to recharge external devices.

## Driver's side

### Opening



Pull the handle.

**!** Close the glove compartment again immediately

Close the glove compartment immediately after use while driving; otherwise, injury may occur during accidents. ◀

### Closing

Fold up the cover.

## Center armrest

### Front

A storage compartment is located in the center armrest between the front seats.

### Opening

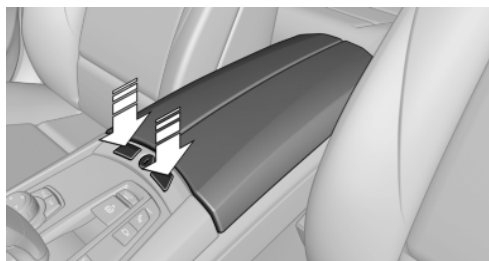

Press the buttons next to the lock.

## Locking the storage compartment



The storage compartment in the armrest can be locked with a key to separately secure the [trunk lid](#), refer to [page 40](#), for example.

After locking the storage compartment, the remote control can be handed out without the [integrated key](#), refer to [page 32](#), e.g., at a hotel.

This prevents access to the storage compartment and trunk.

## Connection for an external audio device

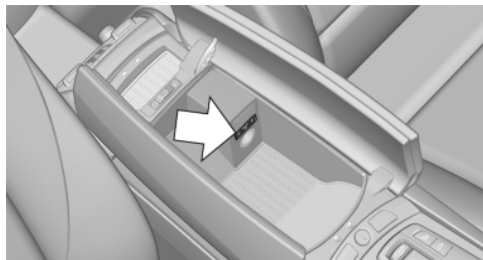

This can be used to connect an external audio device, such as a CD or MP3 player.

- ▷ [AUX-IN port](#), refer to [page 189](#).
- ▷ [USB audio interface\\*](#), refer to [page 190](#).

### Rear

A storage compartment is located in the center armrest between the seats.

### Opening



Depending on the equipment in your vehicle, the button is in the depression at the front of the center armrest or on top of the center armrest.

## Storage compartment between the rear seats\*



A storage compartment is located between the two seat cushions.

To open: press the button.

-  Do not place weight on the cover
-  Do not place weight on the storage compartment cover, such as by sitting on it, as this may damage the cover. ◀

## Storage compartment on the center console

### Opening

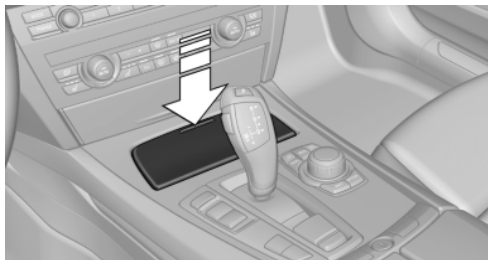

To open: press on the cover.

### Additional storage compartment



To create a large storage compartment on the center console, you can remove the cup holder.



Tip the cup holder insert to the rear and remove it.

## Cup holders

### Notes

-  Shatter-proof containers and no hot drinks
- Use light and shatter-proof containers and do not transport hot drinks. Otherwise, there is the increased danger of injury in an accident. ◀
-  Unsuitable containers
- Do not forcefully push unsuitable containers into the cup holders. This may result in damage. ◀

### Front

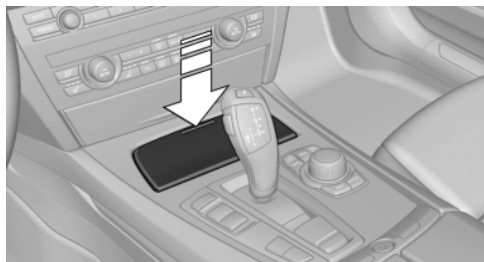

To open: press on the cover.

### Rear

In the front of the center armrest.

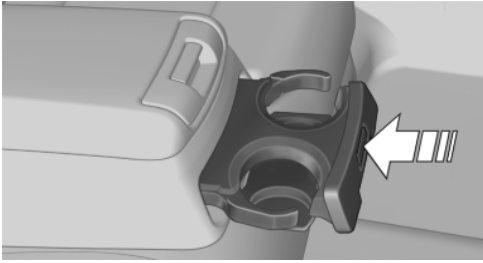

To open: press the button.  
To close: slide back.

## Clothes hooks

The clothes hooks are located next to the grab handles in the rear and on the door pillar in the rear.



Do not obstruct view

When suspending clothing from the hooks, ensure that it will not obstruct the driver's vision.◀



No heavy objects

Do not hang heavy objects from the hooks; otherwise, they may present a danger to passengers during braking and evasive maneuvers.◀

## Trunk

### Net

Smaller objects can be stored in the net on the side of the trunk.

To transport larger objects, it can be pushed down.

## Storage compartment under the floor panel



Raise the floor panel.

## Storage compartment on the side

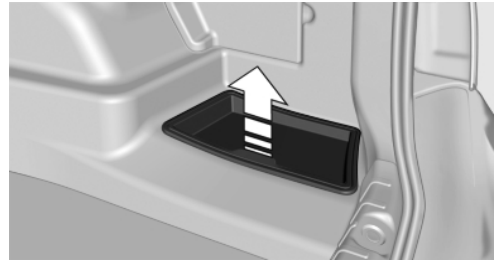

Under the cover on the side of the trunk is a storage compartment that can be used to store the printed Owner's Manual, for example.

Remove the cover.

## Lashing eyes

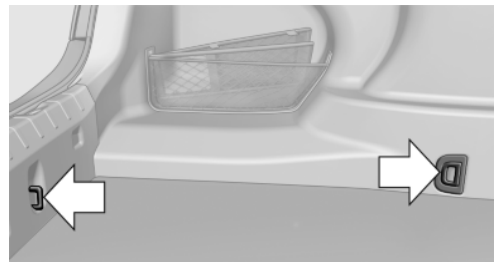

To secure cargo, refer to [page 149](#), with nets or draw straps, the trunk is fitted with lashing eyes.







## Driving tips

This chapter provides you with information useful in dealing with specific driving and operating modes.

# Things to remember when driving

## Breaking-in period

### General information

Moving parts need to be broken in to adjust to each other.

The following instructions will help achieve the optimal operating life and efficiency for your vehicle.

### Engine and differential

Always obey all official speed limits.

### Up to approx. 1,200 miles/2,000 km

Drive at varying engine and road speeds but do not exceed:

- ▶ In gasoline engines, 4,500 rpm or 100 mph/160 km/h.

Avoid full-throttle operation and use of the transmission's kick-down mode for the initial miles.

### From 1,200 miles/2,000 km

The engine and vehicle speed can gradually be increased.

### Tires

Due to technical factors associated with their manufacture, tires do not achieve their full traction potential until after an initial breaking-in period.

Drive conservatively for the first 200 miles/300 km.

### Brake system

Brakes require an initial break-in period of approx. 300 miles/500 km to achieve optimized contact and wear patterns between brake pads and rotors.

### Following part replacement

The same breaking in procedures should be observed if any of the components mentioned

above have to be renewed in the course of the vehicle's operating life.

## General driving notes

### Closing the trunk lid



Drive with the trunk lid closed

Only operate the vehicle with the trunk lid closed; otherwise, exhaust fumes could enter the passenger compartment. ◀

If the vehicle must be driven with the trunk lid open:

1. Close all windows and the glass sunroof\*.
2. Greatly increase the air volume of the automatic climate control system.

### Hot exhaust system



Hot exhaust system

High temperatures are generated in the exhaust system.

Do not remove the heat shields installed and never apply undercoating to them. When driving, standing at idle and while parking, take care to avoid possible contact between the hot exhaust system and any highly flammable materials such as hay, leaves, grass, etc. Such contact could lead to a fire, and with it the risk of serious personal injury as well as property damage.

Do not touch hot exhaust pipes; otherwise, there is the danger of getting burned. ◀

## Climate control windshield

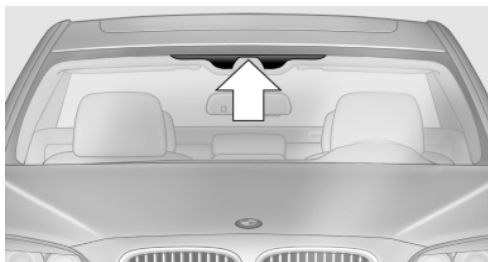

The marked area is not covered with infrared reflective coating.

Use this area for garage door openers, devices for electronic charge collection, etc.

## Mobile communication devices in the vehicle

 Mobile communication devices in the vehicle

It is advised that you do not use mobile communication devices, e.g., mobile phones, inside the vehicle without connecting them directly to the external antenna. Otherwise, the vehicle electronics and mobile communication devices can interfere with each other. In addition, there is no assurance that the radiation generated during transmission will be discharged from the vehicle interior. ◀

## Hydroplaning

On wet or slushy roads, a wedge of water can form between the tires and road surface.

This phenomenon is referred to as hydroplaning. It is characterized by a partial or complete loss of contact between the tires and the road surface, ultimately undermining your ability to steer and brake the vehicle.

 Hydroplaning  
When driving on wet or slushy roads, reduce your speed to prevent hydroplaning. ◀

## Driving through water

Drive through calm water only if it is not deeper than 9.8 inches/25 cm and at this height no faster than walking speed, up to 6 mph/10 km/h.

 Adhere to water depth and speed limitations

Do not exceed this water depth and walking speed; otherwise, the vehicle's engine, the electrical systems and the transmission may be damaged. ◀

## Braking safely

Your vehicle is equipped with ABS as a standard feature.

Applying the brakes fully is the most effective way of braking in situations when this is necessary.

Since the vehicle maintains steering responsiveness, you can still avoid any obstacles with a minimum of steering effort.

Pulsation of the brake pedal and sounds from the hydraulic circuits indicate that ABS is in its active mode.

## Driving in wet conditions

When roads are wet or there is heavy rain, briefly exert gentle pressure on the brake pedal every few miles.

Ensure that this action does not endanger other road users.

The heat generated in this process helps dry the brake discs and pads.

In this way braking efficiency will be available when you need it.

## Hills

Drive long or steep downhill gradients in the gear in which the least braking is required. Otherwise, the brake system may overheat, resulting in a reduction in the brake system efficiency.

You can increase the engine's braking effect by shifting down in the manual mode of the **automatic transmission**, refer to page 71.

 Avoid load on the brakes  
Avoid placing excessive load on the brake system. Light but consistent brake pressure can lead to high temperatures, brake wear and possibly even brake failure. ◀



Do not drive in neutral

Do not drive in neutral or with the engine stopped, as doing so disables engine braking. In addition, steering and brake assist is unavailable with the engine stopped. ◀



No objects in the area around the pedals

Never allow floor mats, carpets or any other objects to protrude into the area of pedal movement and impair pedal operation. ◀

### Brake disc corrosion

Corrosion on the brake discs and contamination on the brake pads are furthered by:

- ▷ Low mileage.
- ▷ Extended periods when the vehicle is not used at all.
- ▷ Infrequent use of the brakes.

Corrosion occurs when the minimum pressure that must be exerted by the pads during brake applications to clean the discs is not reached.

Should corrosion form on the brake discs, the brakes will tend to respond with a pulsating effect that generally cannot be corrected.

### Condensation under the parked vehicle

When using the automatic climate control, condensation water develops that exits underneath the vehicle.

Therefore, traces of condensed water under the vehicle are normal.

## Loading



Overloading the vehicle

To avoid exceeding the approved carrying capacity of the tires, never overload the vehicle. Overloading can lead to overheating and increases the rate at which damage develops inside the tires. This could result in a sudden loss of tire inflation pressure. ◀



No fluids in the trunk

Make sure that fluids do not leak into the trunk; otherwise, the vehicle may be damaged. ◀

### Determining the load limit

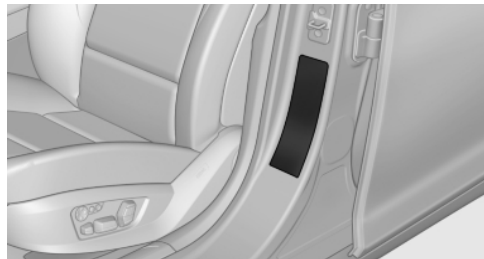

1. Locate the following statement on your vehicle's placard\*:
  - ▷ The combined weight of occupants and cargo should never exceed XXX kg or YYY lbs. Otherwise, damage to the vehicle and unstable driving situations may result.
2. Determine the combined weight of the driver and passengers that will be riding in your vehicle.
3. Subtract the combined weight of the driver and passengers from XXX kilograms or YYY pounds.
4. The resulting figure equals the available amount of cargo and luggage load capacity. For example, if the YYY amount equals 1,400 lbs and there will be five 150 lbs passengers in your vehicle, the amount of available cargo and luggage load capacity is 650 lbs: 1,400 lbs minus 750 lbs = 650 lbs.
5. Determine the combined weight of luggage and cargo being loaded on the vehicle. That weight may not safely exceed the available cargo and luggage load capacity calculated in Step 4.
6. If your vehicle will be towing a trailer, load from your trailer will be transferred to your vehicle. Consult the manual for transporting a trailer to determine how this may reduce the available cargo and luggage load capacity of your vehicle.

## Load

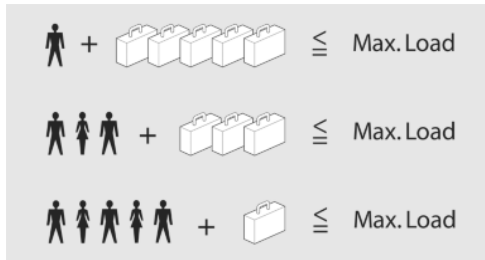

The maximum load is the sum of the weight of the occupants and the cargo.

The greater the weight of the occupants, the less cargo that can be transported.

## Stowing cargo

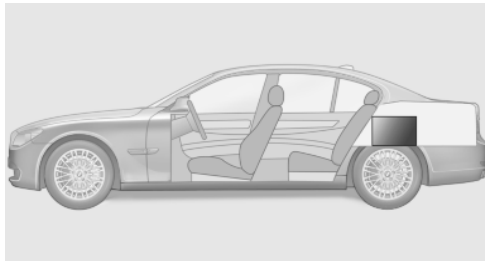

- ▶ Heavy cargo: stow as far forward and as low as possible, ideally directly behind the trunk separating wall.
- ▶ Very heavy cargo: when the rear seat is not occupied, secure each of the outer safety belts in the opposite buckle.
- ▶ Cover sharp edges and corners.

## Securing cargo

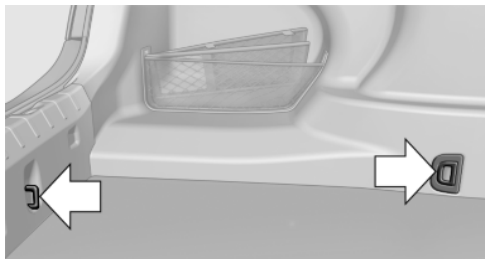

- ▶ Smaller and lighter items: secure with retaining straps, a trunk net\* or draw straps.

- ▶ Larger and heavy objects: secure with cargo straps\*.

Cargo straps can be attached to four lashing eyes located in the trunk.



### Securing cargo

Always position and secure the cargo as described above; otherwise, it can endanger the car's occupants if sudden braking or swerving becomes necessary.

Heavy or hard objects should not be carried loose inside the car; otherwise, they could be thrown around as a result of hard braking, sudden swerves, etc., and endanger the occupants. ◀

## Roof-mounted luggage rack

### Special rack system as optional accessory

A special rack system is available as an optional accessory.

Follow the directions given in the installation instructions.

### Anchorage points

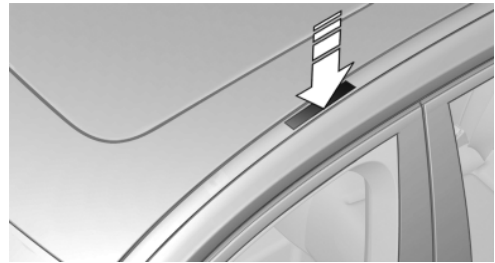

On the outside of the vehicle, press on the edge of the cover.

### Mounting

Be sure that adequate clearance is maintained for raising and opening the glass sunroof\*.

### Magnetic roof-mounted luggage rack

Because of the aluminum roof, magnetic roof-mounted luggage racks cannot be mounted.

## Loading

Because roof racks raise the vehicle's center of gravity when loaded, they have a major effect on vehicle handling and steering response.

Therefore, note the following when loading and driving:

- ▷ Do not exceed the [approved roof/axle loads and the approved gross vehicle weight, refer to page 258](#).
- ▷ Distribute the roof load uniformly.
- ▷ The roof load should not be too large in area.
- ▷ Always load the heaviest pieces on the bottom.
- ▷ Fasten roof-mounted cargo correctly and securely.
- ▷ Do not let objects project into the opening path of the trunk lid.
- ▷ Drive smoothly. Avoid sudden acceleration and braking maneuvers. Take corners gently.

## Saving fuel

### General information

Your vehicle contains advanced technology for the reduction of fuel consumption and emissions.

Fuel consumption depends on a number of different factors.

The implementation of certain measures, driving style and regular [maintenance, refer to page 237](#), can have an influence on fuel consumption and on the environmental impact.

### Remove unnecessary cargo

Additional weight increases fuel consumption.

### Remove attached parts following use

Remove auxiliary mirrors, roof or rear luggage racks which are no longer required following use.

Attached parts on the vehicle impair the aerodynamics and increase the fuel consumption.

### Close the windows and glass sunroof\*

Driving with the glass sunroof and windows open results in increased air resistance and raises fuel consumption.

### Check the tire inflation pressure regularly

Check and, if necessary, correct the [tire inflation pressure, refer to page 226](#), at least twice a month and before starting on a long trip.

Low tire inflation pressure increases rolling resistance and thus raises fuel consumption and tire wear.

### Drive away without delay

Do not wait for the engine to warm up while the vehicle remains stationary. Start driving right away, but at moderate engine speeds.

This is the fastest way for the cold engine to reach its operating temperature.

### Look well ahead when driving

Avoid unnecessary acceleration and braking.

By maintaining a suitable distance to the vehicle driving ahead of you.

Driving smoothly and looking ahead reduces fuel consumption.

### Use coasting conditions

When approaching a red traffic light, take your foot off the accelerator and let the vehicle coast to a halt.

On a downhill gradient, take your foot off the accelerator and let the vehicle roll.

The flow of fuel is interrupted while coasting.

### Switch off the engine during longer stops

Switch off the engine during longer stops, e.g., at traffic lights, railroad crossings or in traffic congestion.

Fuel savings are achieved after the vehicle is switched off for only approx. 4 seconds.

## Switch off any functions that are not currently needed

Functions such as seat heating and the rear window defroster require a lot of energy and consume additional fuel, especially in city and stop-and-go traffic.

Therefore, switch off these functions if they are not actually needed.

## Have maintenance carried out

Have vehicles maintained regularly to achieve optimal vehicle economy and operating life. Have the maintenance carried out by your service center.

Please also note the [BMW Maintenance System](#), refer to [page 237](#).





## Navigation

This chapter contains various examples of how the navigation system can guide you reliably to your destination.

# Navigation

## Navigation system

### General information

The navigation system can determine the precise position of the vehicle, with the aid of satellites and vehicle sensors, and can reliably guide you to every entered destination.

Navigation data are stored in the vehicle and can be updated.



Entries in stationary vehicle

Enter data only when the vehicle is stationary, and always give priority to the applicable traffic regulations in the event of any contradiction between traffic and road conditions and the instructions issued by the navigation system. Failure to take to this precaution can place you in violation of the law and put vehicle occupants and other road users in danger. ◀

## Destination input

### Manual destination entry

#### General information

The system supports you in entering street names and house numbers by automatically completing the entry and [providing entry comparisons, refer to page 24](#).

Stored town/city and street names can be called up quickly.

- ▷ If the existing entries should not be changed, the entries for the state/province and town/city can be skipped.
- ▷ Destination guidance is started to the town/city center if no street is entered.

#### Entering a state/province

1. "Navigation"

2. "Enter address"

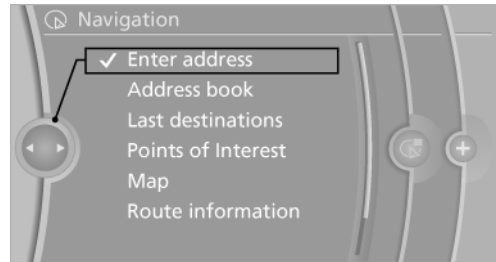

3. Select "State/Province" or the displayed state/province.

#### Entering a town/city

1. Select "Town/City/Postal Code" or the displayed town/city.

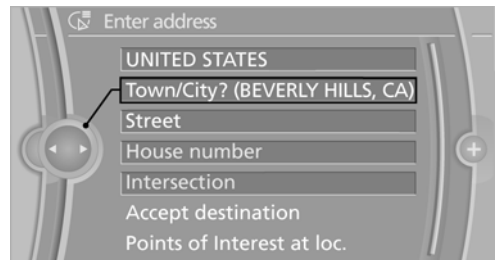

2. Select the letters.  
The list is narrowed down further with each entry.

3. Move the controller to the right.
4. Select the town/city name from the list.

If there are several towns/cities with the same name:

1. Change to the list of town/city names.
2. Highlight the town/city.

A preview map is displayed on the split screen.

3. Select the town/city.

## Entering the postal code

1. Select "Town/City/Postal Code" or the displayed town/city.
2. 1@+ Select the symbol.
3. Select the numbers.
4. Change to the list of postal codes and towns/cities.
5. Highlight the postal code.  
A preview map is displayed on the split screen.
6. Select the postal code.

## Entering a street and intersection

1. Select "Street" or the displayed street.
2. Enter a street and intersection in the same way as you would enter a town/city.

If there are several streets with the same name:

1. Change to the list of street names.  
A preview map is displayed on the split screen.
2. Highlight the street.
3. Select the street.

## Entering a street without a destination town/city

All streets of the selected state/province are offered. The associated town/city is displayed after the street name.

The desired street does not exist in the specified city/town because it belongs to another part of the city/town.

1. "Navigation"
2. "Enter address"
3. Select "Street" or the displayed street.
4. Change to the list of street names.

5. "In" the displayed state/province.

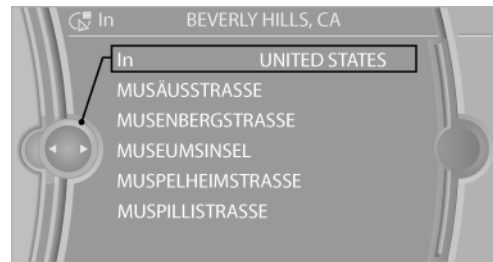

6. Select the letters.
7. Change to the list of street names.
8. Highlight the street.  
A preview map is displayed on the split screen.
9. Select the street.

## Entering a house number

1. "House number"
2. Select the numbers.
3. Change to the list of house numbers.
4. Select a house number or range of house numbers.

## Starting destination guidance after entering the destination

- ▷ "Accept destination". Destination guidance is started immediately.
- ▷ Set the "Route preference", refer to page 161.
- ▷ Search for the "Points of Interest at loc.", refer to page 157.

## Address book

### Selecting a destination from the address book

1. "Navigation"
2. "Address book": contacts are displayed with addresses if these have been checked as destinations.

If the contacts with addresses from the mobile phone\* are not displayed, they first need

to be checked as destinations, refer to page 215.

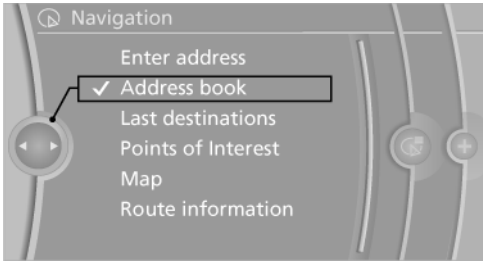

3. Select a contact in the list or, if desired, with "A-Z search".
4. If necessary, select "Business address" or "Home address".

## Storing the destination in the address book

After entering the destination, store the destination in the address book.

1. Open "Options".
2. "Store as new contact" or "Add to existing contact"

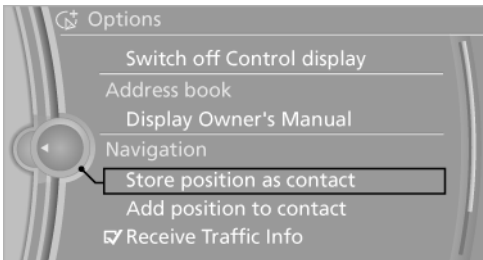

3. Select an existing contact, if available.
4. Select "Business address" or "Home address".
5. Enter "Last name" and, if necessary, "First name".
6. "Store in vehicle"

## Storing the position

The current position can be stored in the address book.

1. "Navigation"

2. Open "Options".
3. "Store position as contact" or "Add position to existing contact"

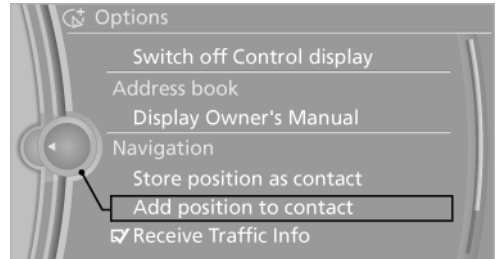

4. Depending on the selection, select an existing contact from the list or the type of address and enter the last and first name.
5. "Store in vehicle"

## Editing or deleting a destination

1. "Navigation"
2. "Address book"
3. Highlight the entry.
4. Open "Options".
5. "Edit in Contacts" or "Delete entry"

## Using the home address as the destination

The home address must be stored. Specify the home address, refer to page 214.

1. "Navigation"
2. "Address book"
3. "Home"

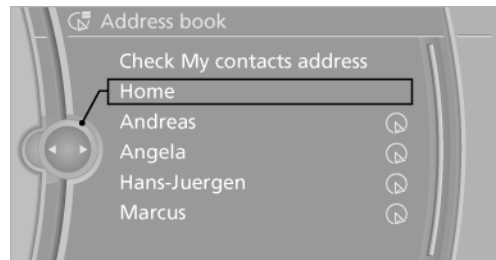

4. Start destination guidance.

## Last destinations

### At a glance

The destinations previously entered are stored automatically.

The destinations can be called up and used as a destination for destination guidance.

### Calling up the last destination

1. "Navigation"
2. "Last destinations"

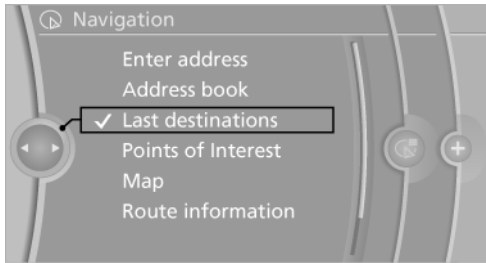

3. Select the destination.
4. Start destination guidance.

### Editing the destination

1. "Navigation"
2. "Last destinations"
3. Highlight the destination.
4. Open "Options".
5. "Edit destination"

### Deleting the last destinations

1. "Navigation"
2. "Last destinations"
3. Highlight the destination.
4. Open "Options".
5. "Delete entry" or "Delete all last destinations"

## Special destinations

### Opening the search for special destinations

To select special destinations, e.g., hotels or tourist attractions:

1. "Navigation"
2. "Points of Interest"

Narrow the search for special destinations by specifying the location and category.

### Position of special destinations

1. "Search area"

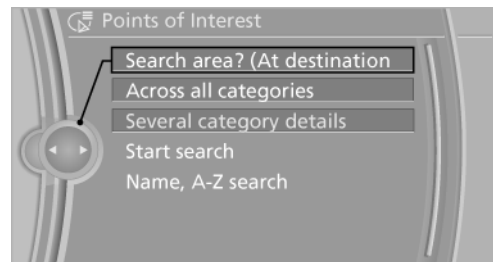

2. Select the location where the system is to search for the special destination: "At current location", "At destination", "At a different destination", "Along route"

### Special destinations category

1. "Category"
2. Select "All" or the specific category of the special destination, e.g., hotels or restaurants.

### Category details

For some special destinations, additional details can be displayed that are available in the navigation data, e.g., Italian-style restaurant.

1. "Points of Interest"

## 2. "Category details"

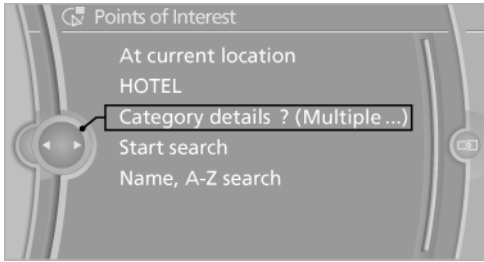

### Starting the search for special destinations

1. "Start search"
2. A list of the special destinations is displayed.
  - ▷ The special destinations "At current location" are listed according to their distance from the current location and are displayed with a directional arrow pointing to the destination.
  - ▷ Destinations of the selected category are displayed in the map view as symbols. The display depends on the scale of the map and the category.
  - ▷ Special destinations "At destination", "At a different destination" and "Along route".
3. Highlight the special destination.  
A preview map is displayed on the split screen.
4. Select a special destination.
5.  Select the symbol. Destination guidance is started to the special destination.  
If a phone number is available, a connection can be established if necessary.

### Destination entry via BMW Assist\*

The Concierge service, refer to page 217, searches for the desired address and sends it to the navigation system for direct entry as a destination.

1. "Navigation"
2. Open "Options".
3. "BMW Assist dest. entry"

### Entering the special destination by its name

1. "Name, A-Z search"
2. Select the letters.  
Depending on the distance, the search may take some time. The list can contain a maximum of 100 entries.
3. Change to the list of special destinations.
4. Highlight the special destination.  
A preview map is displayed on the split screen.
5. Select a special destination.
6.  Select the symbol to start destination guidance.

### Displaying special destinations in the map

To display symbols of the special destinations in the map view:

1. "Navigation"
2. "Map"
3. Open "Options".
4. "Display Points of Interest"

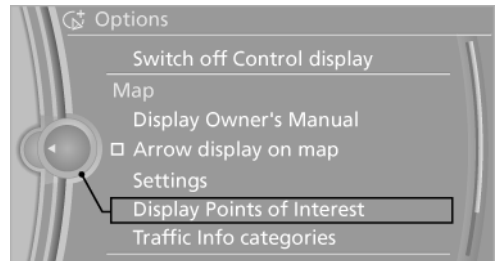

5. Select the setting.

### Destination via map

#### Opening the map

1. "Navigation"
2. "Map"

The map section is displayed. The map shows the current position of the vehicle.

## Selecting the destination

1.  Select the symbol.
2. "Interactive map" is started.

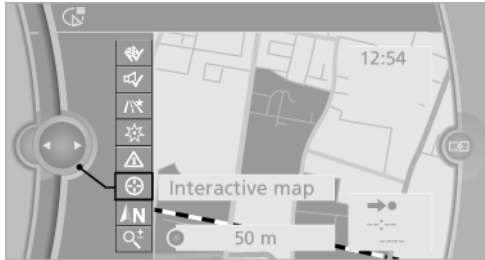

3. Select the destination with crosshairs.
  - ▶ To change the scale: turn the controller.
  - ▶ To shift the map: move the controller in the required direction.
  - ▶ To shift the map diagonally: move the controller in the required direction and turn it.
4. Press the controller to display additional menu items.
  - ▶  Select the symbol: adopt the destination.
  - ▶ "Return": return to the map view.
  - ▶ "Find points of interest": the search for special destinations is started.

## Specifying the street

If the system cannot recognize a street, it displays a street name in the vicinity or the coordinates of the destination.

## Interactive map

In the interactive map, the scale can be adjusted and the visible map section can be shifted. In addition, pressing the controller makes further functions available:

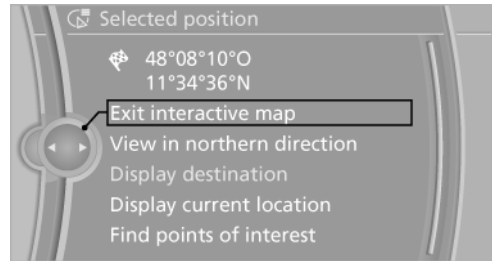

- ▶  Select the symbol. Start destination guidance to the location marked on the map.
- ▶ "Exit interactive map"
- ▶ "View in driving direction" or "View in northern direction"
- ▶ "Display destination": the map section around the destination is displayed.
- ▶ "Display current location": the map section around your current location is displayed.
- ▶ "Find points of interest"

## Destination entry by voice\*

### General information

- ▶ Instructions for the [voice activation system](#), refer to [page 25](#).
- ▶ When entering the destination by voice, you can change between voice operation and the iDrive.
- ▶ To have the available spoken instructions read aloud ›Voice commands:

### Saying the entries

- ▶ Countries, towns and cities, streets, and intersections can be said as whole words or spelled in the [system language](#), refer to [page 81](#).
- ▶ The town/city, street, and house number can be said as a single sentence.
- ▶ Example: to enter a town/city in Germany as a whole word, the language of the system must be German.
- ▶ Spell the entry if the language region and the system language differ.

- ▷ Say the letters smoothly, and avoid exaggerating the pronunciation and inserting lengthy pauses between the letters.

## Entering the address

1.  Briefly press the button on the steering wheel.
2. ›Enter address‹
3. Wait for a request from the system.
4. Specify the desired address in the suggested form.
5. Continue entry as requested by the system.
6. If necessary, individually name the separate components of the address, e.g., the town/city.

## Entering a town/city

The town/city can either be said as a word or spelled.

1. ›City‹ or ›Spell city‹.
2. Wait for the system to prompt you for the town/city.
3. Say the name of the town/city, or name at least the first three letters.  
Depending on the entry, up to 20 towns/cities may be suggested.
4. Select the town/city.
  - ▷ To select a recommended town/city: ›Yes‹
  - ▷ To select a different town/city: ›New entry‹
  - ▷ Select an entry: ›Entry ... ‹ e.g., entry 2
  - ▷ To spell an entry: ›Spell city‹

## Entering a street or intersection

Enter a street or intersection in the same way as you would enter a town/city.

## Entering a house number

House numbers can be entered up to the number 999 999.

›House number‹

Say each digit separately.

## Starting destination guidance

›Start guidance‹

## Storing a destination

The destination is added to the list of last destinations.

## Planning a trip

### New trip

Additional intermediate destinations can be entered for a trip.

1. "Navigation"
2. "Enter address"

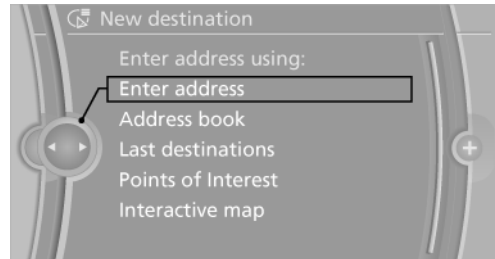

3. "Enter new destination"

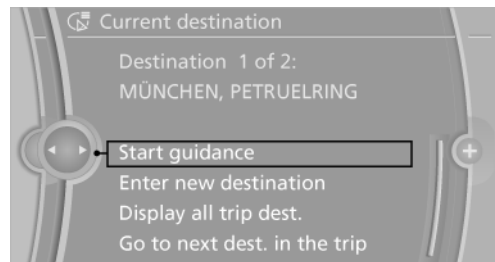

## Entering intermediate destinations

A maximum of 30 intermediate destinations can be entered for one trip.

1. "Enter new destination"
2. "Enter address using:"



3. Select the type of destination entry and enter the intermediate destination.

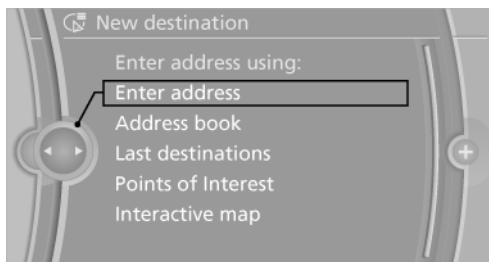

4. Select the location where the intermediate destination is to be inserted: "Reposition dest. in the trip"
5. Select "Add as another dest.", if necessary.

### Starting the trip

After all intermediate destinations have been entered, "Start guidance" directly or select a stored destination: "Stored trips"

### Storing a trip

Up to 30 created trips can be stored in the trip list.

1. Open "Options".
2. "Store trip"
3. Enter the letters.

### Trip direction

The trip direction is reversed: intermediate destinations are displayed in reverse order in the list.

1. "Map"
2. "Guidance"
3. "Reverse order of trip dest."

### Intermediate destination options

1. "Destination in the trip"
2. Select an intermediate destination.
  - ▷ "Reposition dest. in the trip": move an intermediate destination to another position in the list.
  - ▷ "Delete dest. in the trip"

### Deleting a trip

1. "Stored trips"
2. Highlight the desired trip.
3. Open "Options".
4. "Delete all trips" or "Delete trip"

## Destination guidance

### Starting destination guidance

1. "Navigation"
2. Make a [destination entry](#), refer to [page 154](#).
3. "Accept destination"
  - ▷ The route is shown on the Control Display.
  - ▷ The distance to the destination/intermediate destination and the estimated time of arrival are displayed in the map view.
  - ▷ The arrow view is displayed in the instrument cluster.

### Terminating destination guidance

1. "Navigation"
2. "Map"
3.  Select the symbol.

### Continuing destination guidance

If the destination was not reached at the end of the last trip, a message is displayed asking whether destination guidance should be continued.

"Resume guidance"

### Route criteria

#### General information

- ▷ The route calculated can be influenced by selecting certain criteria.
- ▷ The route criteria can be changed when the destination is entered and during destination guidance.

- ▷ Road types are part of the navigation data and are taken into consideration when planning a route, e.g., avoid highways.
- ▷ The recommended route may differ from the route you would take based on personal experience.
- ▷ The settings are stored for the remote control currently in use.

## Changing the route criteria

1. "Navigation"
2. "Map"
3. "Route preference"
4. Select the criterion:
  - ▷ "Fast route": time-optimized route, being a combination of the shortest possible route and the fastest roads.
  - ▷ "Efficient route": optimized combination of the fastest and shortest route.
  - ▷ "Short route": short distance, irrespective of how fast or slow progress will be.
  - ▷ "Alternative routes": other suggested alternative routes.

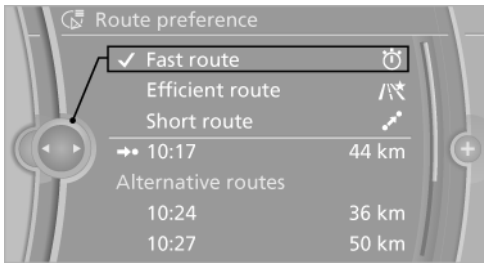

5. Specify additional criteria for the route, if necessary:
  - ▷ "Avoid highways": highways are avoided wherever possible.
  - ▷ "Avoid toll roads": toll roads are avoided wherever possible.
  - ▷ "Avoid ferries": ferries are avoided where possible.

## Dynamic destination guidance

The route is automatically changed in the event of traffic obstructions.

- ▷ The system does not point out traffic obstructions along the original route.
- ▷ Traffic bulletins continue to be displayed on the map.
- ▷ Depending on the type of road and the nature and length of the traffic obstruction, the route can also be calculated so that you travel through the traffic obstruction.

## Activating dynamic destination guidance

1. "Navigation"
2. Open "Options".
3. "Dynamic guidance"

## Route

Different views of the route are available during destination guidance:

- ▷ Arrow view in the instrument cluster.
- ▷ List of streets and towns/cities.
- ▷ [Map view, refer to page 163.](#)
- ▷ [Arrow view in the Head-up Display\\*, refer to page 124.](#)

## Arrow view

During destination guidance, the instrument cluster shows the:

- ▷ Direction of travel.
- ▷ Intersection view.
- ▷ Lane information.
- ▷ Traffic bulletins.
- ▷ Distance to next change in direction.
- ▷ Street name at next change in direction.

## Displaying a list of streets or towns/cities on the route

When destination guidance is started, a list of the streets and towns/cities on the route is displayed. The driving distances and traffic bulletins are displayed for each route section.

1. "Navigation"
2. "Route information"
3. Highlight a section.

The route section is displayed on the split screen.

## Bypassing a section of the route

Calculate a new route for a route section.

1. "Navigation"
2. "Route information"
3. "New route for:"

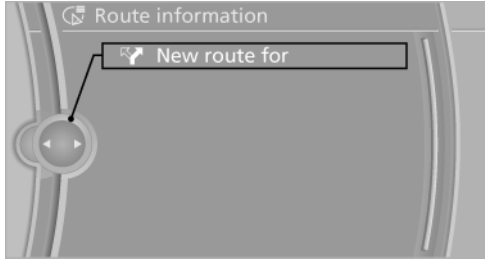

4. Turn the controller. Enter the desired number of miles.
5. Press the controller.

If the route section should no longer be bypassed, call up the menu again and "Remove blocking"

## Gas station recommendation

The vehicle calculates the range and recommends several gas stations along the route.



1. "Navigation"
2. "Route information"
3. "Recommended refuel"  
A list of the gas stations is displayed.
4. Highlight a gas station.  
The gas station is displayed on the split screen.
5. Select the gas station.
6.  Select the symbol to start destination guidance.

## Switching spoken instructions on/off

The setting is stored for the remote control currently in use.

1. "Navigation"

2. "Map"
3. Select the symbol.

Symbol	Meaning
	Spoken instructions are switched on
	Spoken instructions are switched off

## Repeating spoken instructions

1. "Navigation"
2. "Map"
3.  Highlight the symbol.
4. Press the controller twice.

## Volume of spoken instructions

Turn the volume button while giving an instruction until the desired volume is set.

## Saving the spoken instructions on the programmable memory buttons

The function for switching the spoken instructions on/off can be stored on a [programmable memory button](#), refer to page 23, for quick access.

## Map view

### Selecting the map view

Your location is indicated on the map.

After destination guidance is started, the planned route is displayed on the map.

The settings are stored for the remote control currently in use.

1. "Navigation"
2. "Map"

The following functions are directly available in the map view:

Symbol	Function
	Starting/ending destination guidance
	Switching spoken instructions on/off
	Changing the route criteria
	Searching for special destinations
	Displaying traffic bulletins
	Interactive map
	Map view settings
	Changing the scale

## Changing the map section

Open the interactive map.

- ▷ To shift the map: move the controller in the required direction.
- ▷ To shift the map diagonally: move the controller in the required direction and turn it.

## Changing the scale

1. Select the symbol.
2. To change the scale: turn the controller.

## Automatically scaled map scale

In the map view facing north, turn the controller in any direction until the AUTO scale is displayed. The map shows the entire range from your location to the destination.

## Settings for the map view

The map is shown on the Control Display.

1. Open "Options".
2. "Settings"

Set the optimized map view.

- ▷ "Day/night mode"
  - Depending on the light conditions, select and create the necessary settings. When the

traffic bulletin map is activated, this setting is disregarded.

- ▷ "Satellite images"
  - Depending on availability and resolution, satellite images\* are displayed in scales from 2 km to 1,000 km.
- ▷ "Perspective view in 3D"
  - Displays a spatial view. Prominent areas that are contained in the navigation data are displayed on the map in 3D.
- ▷ "Traffic Info map"

## Split screen settings

The map settings for the split screen can be created separately from the main screen:

1. Open "Options".
2. "Split screen"
3. Select the setting.
  - ▷ "Arrow display"
  - ▷ "View facing north"
  - ▷ "View in dir. of travel"
  - ▷ "Perspective view"
  - ▷ "Exit ramp view"
4. To change the scale: change to the split screen and turn the controller.

## Traffic bulletins\*

### At a glance

- ▷ Display the traffic bulletins from radio stations that broadcast the TMC (Traffic Message Channel) of a traffic information service. Information on traffic obstructions and hazards is updated continuously.

Certain BMW models equipped with navigation have the capability to display real-time traffic information. If your system has this capability the following additional terms and conditions apply:

An End-User shall no longer have the right to use the Traffic Data in the event that the

End-User is in material breach of the terms and conditions contained herein.

A. Total Traffic Network, a division of Clear Channel Broadcasting, Inc. ("Total Traffic Network") holds the rights to the traffic incident data and RDS-TMC network through which it is delivered. You may not modify, copy, scan or use any other method to reproduce, duplicate, republish, transmit or distribute in any way any portion of traffic incident data. You agree to indemnify, defend and hold harmless BMW of North America, LLC. ("BMW NA") and Total Traffic Network, Inrix, Inc (and their affiliates) against any and all claims, damages, costs or other expenses that arise directly or indirectly out of (a) your unauthorized use of the traffic incident data or the RDS-TMC network, (b) your violation of this directive and/or (c) any unauthorized or unlawful activities by you in connection herewith.

B. Total Traffic Network traffic data is informational only. User assumes all risk of use. Total Traffic Network, BMW NA, and their suppliers make no representations about content, traffic and road conditions, route usability, or speed.

C. The licensed material is provided to licensee "as is," and "where is". Total Traffic Network, including, but not limited to, any and all third party providers of any of the licensed material, expressly disclaims, to the fullest extent permitted by law, all warranties or representations with respect to the licensed material (including, without limitation, that the licensed material will be error-free, will operate without interruption or that the traffic data will be accurate), express, implied or statutory, including, without limitation, the implied warranties of merchantability, non-infringement fitness for a particular purpose, or those arising from a course of dealing or usage of trade.

D. Neither Total Traffic Network, Inrix, Inc. or BMW NA will be liable to you for any indirect, special, consequential, exemplary, or incidental damages (including, without limita-

tion, lost revenues, anticipated revenues, or profits relating to the same) arising from any claim relating directly or indirectly to use of the traffic data, and even if Total Traffic Network, Inrix, Inc., or BMW NA are aware of the possibility of such damages. These limitations apply to all claims, including, without limitation, claims in contract and tort (such as negligence, product liability and strict liability). Some states do not allow the exclusion or limitation of incidental or consequential damages, so those particular limitations may not apply to you.

- ▶ The traffic information is displayed in the map.

## Switching the reception on/off

1. "Navigation"
2. Open "Options".
3. "Receive Traffic Info"

## Opening the traffic bulletins

1. "Navigation"
2. "Map"
3. "Traffic Info"

Move the controller to the left.

Select .

First, the traffic bulletins on the planned route are displayed.

The traffic bulletins are sorted in the order of their distance from the current vehicle position.

4. Select a traffic bulletin.

 Select the symbol to obtain additional information.

## Traffic bulletins in the map

When the traffic bulletin map is activated, the Control Display changes to a black and white display. This enables a better view of the traffic bulletins. The day/night mode is disregarded in this setting.

1. "Navigation"
2. "Map"

3. "Options"
4. "Settings"
5. "Traffic Info map": the map is optimized for displaying traffic bulletins. Symbols and special destinations are not displayed.

## Symbols in the map view

Depending on the scale of the map and the location of the traffic obstruction along the route, the symbols for the traffic obstructions are displayed.

## Additional information in the map view

Depending on the map scale, a traffic obstruction's length, direction, and impact are displayed in the map using triangles or gray bars along the calculated route.

## Filtering of traffic bulletins

Set which traffic bulletins are to be displayed in the map.

1. "Navigation"
2. "Map"
3. Open "Options".
4. "Traffic Info categories"
5. Set the filter.



Traffic bulletins of the selected category are displayed in the map.

- ▷ Traffic bulletins on incidents along the route are always displayed.
- ▷ For your own safety, traffic bulletins that notify you of potentially dangerous situations, such as wrong-way drivers, cannot be hidden.

## Traffic bulletins during destination guidance

- ▷ The system behavior depends on whether "Dynamic guidance", refer to page 162, is selected or not.
- ▷ During destination guidance, obstructions on the route are taken into consideration.
- ▷ Sources of great danger are displayed regardless of the setting.

## Traffic obstructions

The system calculates the optimized route, taking into consideration traffic obstructions and road types.

## Selecting a detour

Set whether specific traffic obstructions or all traffic obstructions should be taken into consideration during route planning.

1. "Navigation"
2. "Traffic Info"
3. Select a traffic obstruction that you wish to bypass.
4. "Activate detour"

## Taking traffic obstructions into consideration

1. "Navigation"
2. "Traffic Info"
3. First, the traffic bulletins on the planned route are displayed. The traffic bulletins are sorted in the order of their distance from the current vehicle position.
4. Select "Recomm. detour", if necessary.  
"Dynamic guidance" is activated automatically.

## Navigation data

### General information

Navigation data and authorization codes are available from your service center.

Depending on the data volume, a data update may take several hours.

- ▷ Update during a trip.
- ▷ The update is resumed automatically when a trip is continued after an interruption.
- ▷ All functions are available during the trip.
- ▷ The data are stored on the hard disk or in the internal memory.
- ▷ The system restarts after the update.
- ▷ The data carrier with the navigation data can be removed after the update is complete.

## Updating the navigation data

1. Insert navigation DVDs into the DVD player with the labeled side facing up.
2. Follow the instructions on the Control Display.
3. Enter the authorization code of the navigation DVDs and change the DVDs if needed.

## Information on navigation data

1. "Navigation"
2. Open "Options".
3. "Navigation system version" information is displayed on the data version.

## What to do if...

- ▷ The current position cannot be displayed?  
The vehicle is located in an unrecognized region, is in a poor reception area, or the system is currently determining the position. Reception is usually best when you have an unobstructed view of the sky.
- ▷ Destination guidance does not accept a destination without the street?  
When city has been input, no downtown can be determined.  
Input any street in the selected city and start destination guidance.
- ▷ Destination guidance does not accept a destination?

The destination data is not contained in the navigation data. Select a destination that is as close as possible to the original.

- ▷ The letters for the destination input cannot be selected?

The stored data do not contain the data of the destination.

Select a destination that is as close as possible to the original.

- ▷ The map view is displayed in black and white?

When the traffic bulletin map is activated, the Control Display changes to a black and white display. This enables a better view of the traffic bulletins.

- ▷ Spoken instructions are no longer given before intersections during destination guidance?

The area has not yet been fully recorded, or you have left the recommended route and the system requires a few seconds to calculate a new route suggestion.





## Entertainment

The chapter helps assure your enjoyment when receiving radio and television stations and playing CDs, DVDs and tracks from the music collection.

# Tone

## General information

The sound settings are stored for the remote control currently in use.

## Treble, bass, balance, and fader

- ▷ "Balance": left/right volume distribution.
- ▷ "Fader": front/rear volume distribution.

## Setting treble, bass, balance, and fader

1. "CD/Multimedia", "Radio" or "Settings"
2. "Tone"

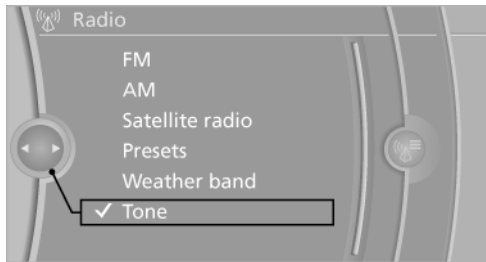

3. Select the desired tone settings.

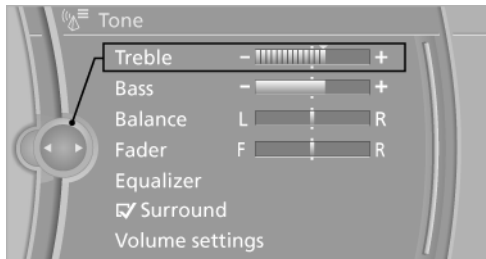

4. To adjust: turn the controller.
5. To confirm: press the controller.

## Equalizer\*

Setting for individual audio frequency ranges.

## Adjusting the equalizer

1. "CD/Multimedia", "Radio" or "Settings"
2. "Tone"
3. "Equalizer"
4. Select the desired setting.



5. To adjust: turn the controller.
6. To store: press the controller.

## Multi-channel playback, surround\*

Choose between stereo and multi-channel playback, surround.

## Setting multi-channel playback, surround

1. "CD/Multimedia", "Radio" or "Settings"
2. "Tone"
3. "Surround"

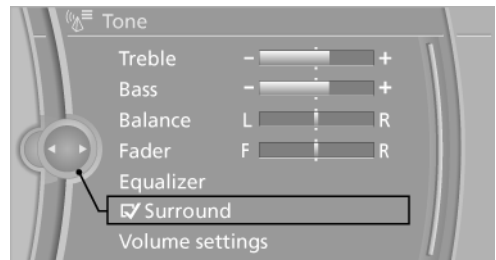

Multi-channel playback, surround, is simulated when playing back an audio track in stereo.

Multi-channel playback is automatically activated or deactivated, depending on the audio track selected.

## Volume

- ▷ "Speed volume": speed-dependent volume control.
- ▷ "PDC": volume of the PDC signal compared to the entertainment sound output.
- ▷ "Gong": volume of the signal, such as the safety belt reminder, compared to the entertainment sound output.

### Adjusting the volume

1. "CD/Multimedia", "Radio" or "Settings"
2. "Tone"
3. "Volume settings"
4. Select the desired volume setting.

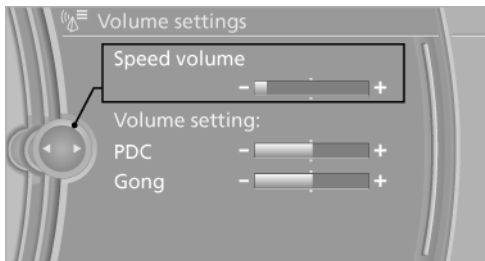

5. To adjust: turn the controller.
6. To store: press the controller.

### Resetting the tone settings

1. "CD/Multimedia", "Radio" or "Settings"
2. "Tone"
3. "Reset"

# Radio

## Controls

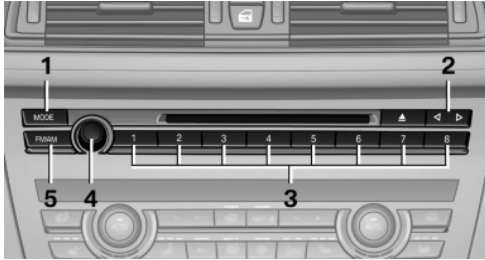

- 1 Change entertainment sources
- 2 Change station/track
- 3 Programmable memory buttons
- 4 Volume, on/off
- 5 Change wave band

## AM/FM station

### Selecting a station

1. "Radio"

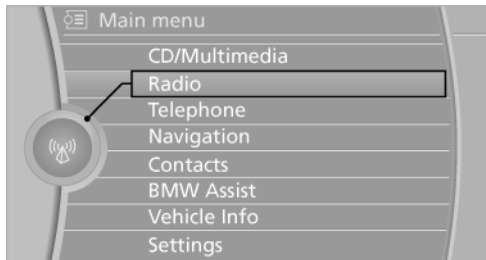

2. "FM" or "AM"
3. Select the desired station.

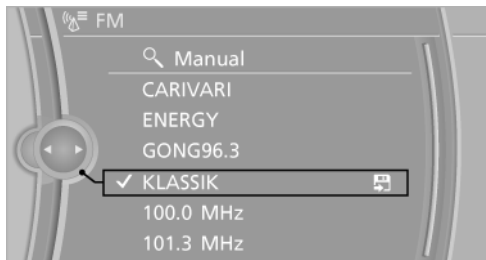

All saved stations are stored for the remote control currently in use.

### Changing the station via the button



Press the button.

### Storing a station

1. "Radio"
2. "FM" or "AM"
3. Highlight the desired station.

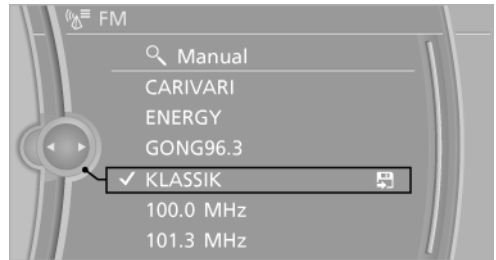

4. Press the controller for an extended period.
5. Select the desired memory location.

The stations are stored for the remote control currently in use.

The stations can also be stored on the [programmable memory buttons](#), refer to [page 23](#).

### Selecting a station manually

Station selection via the frequency.

1. "Radio"
2. "FM" or "AM"
3. "Manual"

- To select the frequency: turn the controller.

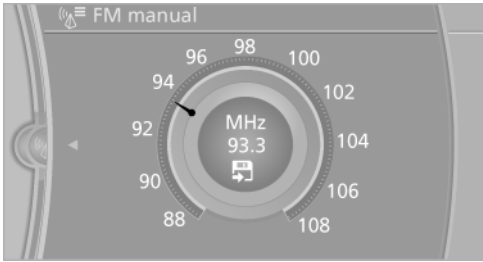

To store the station: press the controller for an extended period.

### RDS\*

RDS broadcasts additional information, such as the station name, in the FM wave band. When playing a station with multiple frequencies, the system automatically switches to the frequency with the best reception, if needed.

### Switching the RDS on/off

- "Radio"
- "FM"
- Open "Options".
- "RDS"



The setting is stored for the remote control currently in use.

### HD Radio\*

Many stations broadcast both analog and digital signals.

License conditions

HD Radio™ technology manufactured under license from iBiquity Digital Corp. U.S. and Foreign Patents. HD Radio™ and the HD and HD

Radio logos are proprietary trademarks of iBiquity Digital Corp.

### Activating/deactivating digital radio reception

- "Radio"
- "FM" or "AM"
- Open "Options".
- "HD Radio"

The setting is stored for the remote control currently in use.

 This symbol is displayed in the status line when the audio signal is digital.

In areas in which the station is not continuously received in digital mode, the playback switches between analog and digital reception. Due to time delayed broadcasting, there may be repetitions or interruptions. In this case, switch off digital radio reception.

### Displaying additional information

Some stations broadcast additional information on the current track, such as the name of the artist.

- Select the desired station.
- Open "Options".
- "Station info"

### Selecting a substation

The  symbol indicates that a main station also broadcasts additional substations. The station name of the main station ends in HD1. Station names of the substations end in HD2, HD3, etc.

- Select the desired station.
- Press the controller.
- Select the substation.

When reception is poor, the substation is muted for several seconds. If reception is interrupted for an extended period, it switches back to the main station.

## Weather Band\*

### General information

The availability of the Weather Band and the number of available channels can vary depending on the region.

### Switching on the Weather Band

1. "Radio"
2. "Weather band"
3. Select the desired channel.

### Additional information





Weather Band is a service of the National Oceanic and Atmospheric Administration (NOAA). Additional information on the Internet: [www.nws.noaa.gov](http://www.nws.noaa.gov).

## Satellite radio\*

### General information

The channels are offered in predefined packages. The packages must be enabled by telephone.

### Navigation bar overview

Symbol	Function
	Change the list view.
	Select the category.
	Direct channel entry
	Timeshift
	Open the favorites, open the My Favorites category.
	Manage the favorites.
	Traffic Jump

The functions of the navigation bar symbols can also be stored on the [programmable memory buttons](#), refer to page 23.

## Managing a subscription

To be able to enable or disable the channels, you must have reception. It is usually at its best when you have an unobstructed view of the sky. The channel name is displayed in the status line.

### Enabling channels

The Unsubscribed Channels category contains all disabled channels.

1. "Radio"
2. "Satellite radio"
3.  "Categories"



4. Select the Unsubscribed Channels category.
5. Select the desired channel.  
The phone number and an electronic serial number, ESN, are displayed.
6. Select the phone number to have the channel enabled.

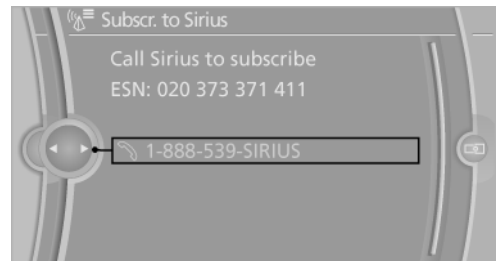

You can unsubscribe from the channels again via this phone number.

### Unsubscribing from channels

1. "Radio"
2. "Satellite radio"

3. Open "Options".
4. "Manage subscription"

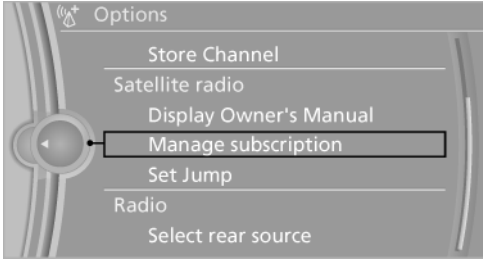

5. The phone number and an electronic serial number, ESN, are displayed.
6. Call Sirius to unsubscribe from the channels.

## Selecting channels

You can only listen to enabled channels.

The selected channel is stored for the remote control currently in use.

### Via the iDrive

1. "Radio"
2. "Satellite radio"
3. Select "All Channels" or the desired category.
4. Select the desired channel.



### Via the buttons on the center console



Press the button.

The next channel is selected.

### Via direct channel entry

1. "Radio"

2. "Satellite radio"
3. "Select channel"
4. Turn the controller until the desired channel is reached and press the controller.

## Storing a channel

1. "Radio"
2. "Satellite radio"
3. If necessary, open "All Channels" or the desired category.
4. Select the desired channel.
5. Press the controller again.
6. Press the controller again to confirm the highlighted channel.

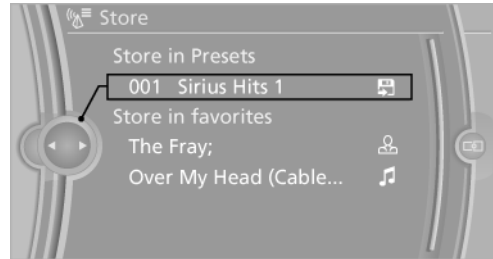

7. Select the desired memory location.

The channels are stored for the remote control currently in use.

The channels can also be stored on the [programmable memory buttons](#), refer to page 23.

## Changing the list view

The list view changes every time the first symbol on the navigation bar is pressed.

Information on the channel is displayed.

Symbol	Meaning
	Channel name
	Artist
	Track

## Selecting a category

1. "Radio"
2. "Satellite radio"

3.  "Categories"
4. Select the desired category.

## Timeshift

Approx. one hour of the program being broadcast on the channel currently being listened to is stored in a buffer. The signal must be available. The stored audio track can be played with a delay following the live broadcast. When the buffer is full, the older tracks are overwritten. The buffer is cleared when a new channel is selected.

### Opening the timeshift function



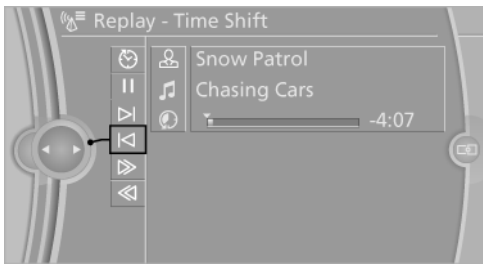

1. "Radio"
2. "Satellite radio"
3.  "Replay - Time Shift"



A new panel opens.



- ▶ The red arrow shows the current playback position.
- ▶ The time difference to the live broadcast is displayed next to the buffer bar.
- ▶ If playback is live, "live" is displayed next to the buffer bar.

### Timeshift menu

Symbol	Function
	Go to the live broadcast
	Playback/pause
	Next track
	Previous track

Symbol	Function
	Fast forward
	Reverse

### Storing favorites

Up to 30 favorites can be stored in the favorites list. Available favorites are artist, track, game, league, and team.

### Storing the artist, track, or game

It is possible to store favorites that are currently being broadcast. The channel information must be available.

1. "Radio"
2. "Satellite radio"
3. If necessary, open "All Channels" or the desired category.
4. Select the desired channel.
5. Press the controller again.
6. Select the artist, track, or game.

### Storing the league or team

Leagues or teams can be added to the favorites from a selection list.

1. "Radio"
2. "Satellite radio"
3.  "Manage favorites"
4. "Add sports information"



5. Select a league or team.



## Opening the favorites

When an activated favorite is playing, the following message appears for approx. 20 seconds: "Playing favorite!".

☆ Select "Favorites" while the message is being displayed.



The displayed favorite is played.

If there is no message, the system changes to the My Favorites category. All favorites currently being broadcast can be selected from a list.

## Managing the favorites

### Activating/deactivating the favorites

Favorites can be activated and deactivated globally and individually.

1. "Satellite radio"
2. ☆ "Manage favorites"
3. Select "Activate alert" or the desired favorites.

The setting is stored for the remote control currently in use.

### Deleting favorites

1. "Satellite radio"
2. ☆ "Manage favorites"
3. Highlight the desired favorite.
4. Open "Options".
5. "Delete entry"

## Traffic Jump

Traffic and weather information for a selected region is broadcast every few minutes.

## Selecting a region

1. "Radio"
2. "Satellite radio"
3. Open "Options".
4. "Set Jump"
5. Select the desired region.

The region is stored for the remote control currently in use.

## Activating/deactivating the jump

1. "Radio"
2. "Satellite radio"
3. ↻ "Jump to:"

Information for the selected region is broadcast as soon as it is available.

A new panel opens. Canceling the Traffic Jump: "Cancel".

Symbol	Meaning
↻	Information will be broadcast shortly.
↻	Information is currently being broadcast.

Select one of the symbols to deactivate Traffic Jump.

## Automatic update

About twice a year, Sirius performs an update of the channel names and positions. The update takes place automatically and may take several minutes.

## Notes

- ▷ Reception may not be available under certain circumstances, depending on environmental or topographic conditions. The satellite radio has no influence on this.
- ▷ The signal may not be available in tunnels or underground garages; next to tall buildings; or near trees, mountains or other powerful sources of radio interference.

## Stored stations

### General information

It is possible to store up to 40 stations.

### Calling up a station

1. "Radio"
2. "Presets"
3. Select the desired station.

### Storing a station

The station currently selected is stored.

1. "Radio"
2. "Presets"
3. "Store station"



4. Select the desired memory location.

The list of stored stations is stored for the remote control currently in use.

The stations can also be stored on the [programmable memory buttons](#), refer to [page 23](#).

### Deleting a station

1. "Radio"
2. "Presets"
3. Select the desired station.
4. Open "Options".
5. "Delete entry"

# CD/multimedia

## Controls

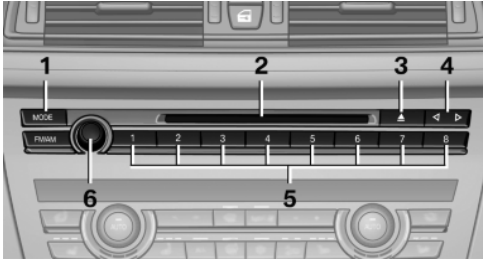

- 1 Change the entertainment source
- 2 CD/DVD\* drive
- 3 Eject CD/DVD
- 4 Change station/track
- 5 Programmable memory buttons
- 6 Volume, on/off

## CD/DVD\*

### CD/DVD playback

#### Loading the CD/DVD player

Insert the CD/DVD with the printed side up. Playback begins automatically. Reading can take a few minutes with compressed audio files.

#### Starting playback

There is a CD/DVD in the CD/DVD player or changer.

#### 1. "CD/Multimedia"

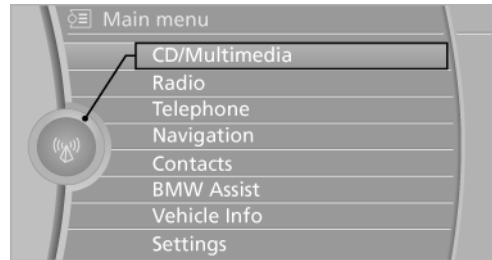

#### 2. "CD/DVD"

#### 3. Select the desired CD or DVD:

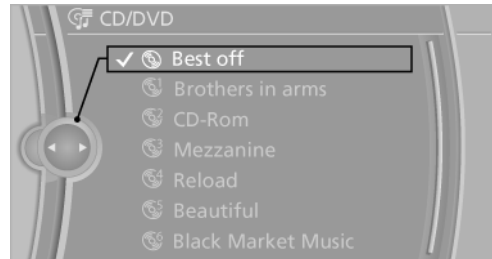

Symbol	Meaning
	CD/DVD player
	DVD changer*
	CD/DVD player, rear*

### Playable formats

- ▶ DVD: DVD-ROM, DVD-R, DVD+R, DVD-RW, DVD+RW, DVD-R DL, DVD+R DL, DVD audio (video part only), DVD video\*.
- ▶ CD: CD-ROM, CD-R, CD-RW, CD-DA, VCD\*, SVCD\*.
- ▶ Compressed audio files: MP3, WMA, AAC.

### Audio playback

#### Selecting the track using the button

Press the button repeatedly until the

desired track is played.

## Selecting the track using the iDrive

### Audio CDs

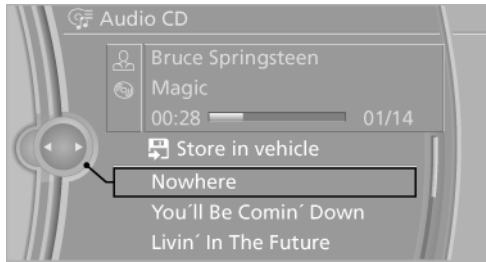

Select the desired track to begin playback.

### CDs/DVDs\* with compressed audio files

Depending on the data, some letters and numbers of the CD/DVD may not be displayed correctly.

1. Select the directory if necessary.

To change to a higher level directory: move the controller to the left.

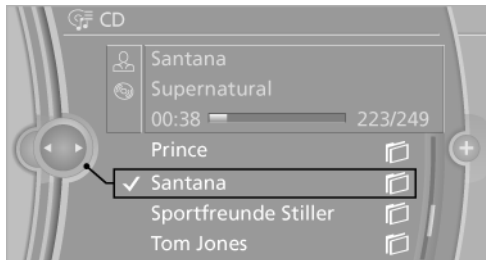

2. Select the desired track to begin playback.

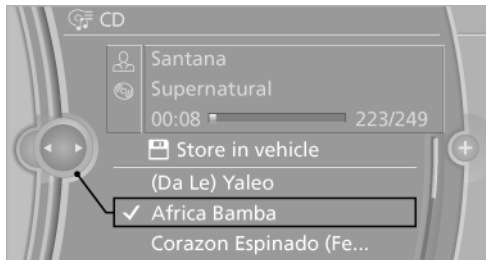

## Displaying information on the track

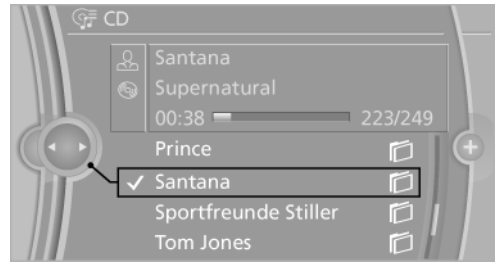

If information about a track has been stored, it is displayed automatically:

- ▶ Interpret.
- ▶ Album track.
- ▶ Number of tracks on the CD/DVD.
- ▶ File name of track.

## Random playback

1. "CD/Multimedia"
2. "CD/DVD"
3. Select the desired CD or DVD.
4. Open "Options".
5. "Random"

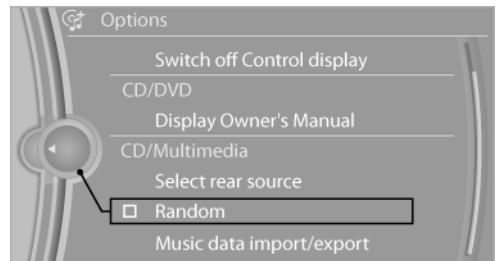

CDs/DVDs with compressed audio files: all tracks within the selected directory are played in random order.

Random mode is switched off when the audio source is changed and the ignition is switched off.

## Fast forward/reverse

 Press and hold the button.

## Automatic repeat\*

The selected track, directories, or CDs/DVDs are repeated automatically.

## Video playback\*

### Country codes

Only DVDs with the code of the home region can be played back; also refer to the information on the DVD.

Code	Region
1	USA, Canada
2	Japan, Europe, Middle East, South Africa
3	Southeast Asia
4	Australia, Central and South America, New Zealand
5	Northwest Asia, North Africa
6	China
0	All regions

## Playback

The video image is displayed on the front Control Display up to a speed of approx. 2 mph/3 km/h; in some countries, it is only displayed if the parking brake is set or if the automatic transmission is in position P.

### DVD video

1. "CD/Multimedia"
2. "CD/DVD"
3. Select a DVD with video content.

### 4. **DVD** "DVD menu"

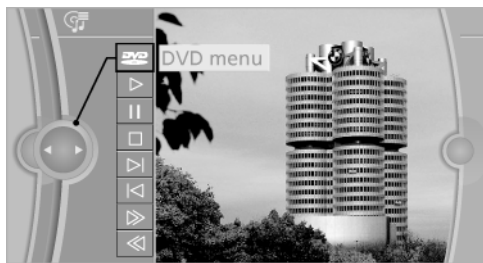

### VCD/SVCD

1. "CD/Multimedia"
2. "CD/DVD"
3. Select a CD with video content.
4. "Select track"

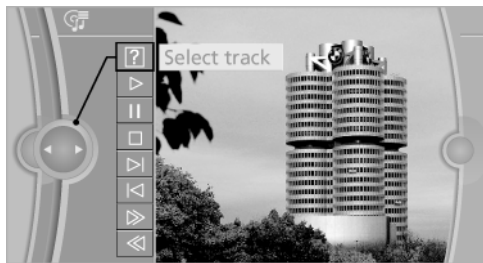

5. Select the desired track.

## Video menu

To open the video menu: turn the controller during playback.

Press the controller when "Back" is displayed.

Symbol	Function
<b>DVD</b>	Open the DVD menu.
▷	Start playback.
	Pause
□	Stop
▷◁	Next chapter
◁◁	Previous chapter
▷▷	Fast forward
◀	Reverse

In fast forward/reverse: the speed increases every time the controller is pressed. To stop, start playback.

### DVD menu

1. If necessary, turn the controller to open the video menu.
2. **DVD** "DVD menu"  
The DVD menu is displayed. The display depends on the contents of the DVD.
3. To select menu items: move the controller and press it.

To change to the video menu: turn the controller and press it.

### DVD/VCD settings

For some DVDs, settings can only be made via the DVD menu; refer also to the information on the DVD.

### Selecting the language\*

The languages that are available depend on the DVD.

1. Turn the controller during playback.
2. Open "Options".
3. "Audio/language"

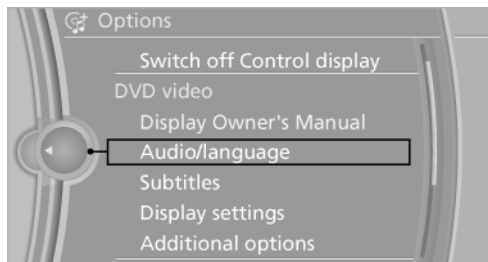

4. Select the desired language.

### Selecting the subtitles\*

The subtitles that are available depend on the DVD.

1. Turn the controller during playback.
2. Open "Options".
3. "Subtitles"

4. Select the desired language or "Do not display subtitles".

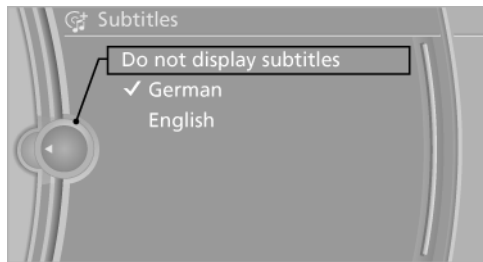

### Setting the brightness, contrast and color

1. Turn the controller during playback.
2. Open "Options".
3. "Display settings"
4. "Brightness", "Contrast" or "Color"

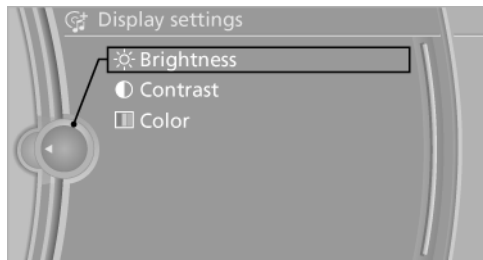

5. Turn the controller until the desired setting is reached and press the controller.

### Selecting the zoom

Display the video image on the entire screen.

1. Turn the controller during playback.
2. Open "Options".
3. "Additional options"
4. "Zoom mode"

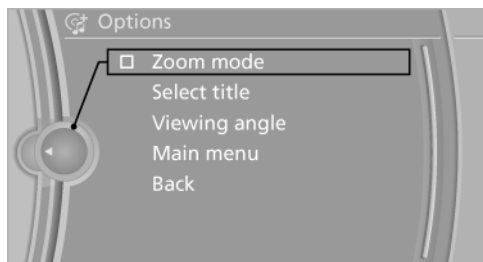

## Selecting a track

DVD video:

1. Turn the controller when the DVD menu is displayed.
2. Open "Options".
3. "Additional options"
4. "Select title"
5. Select the desired track.

VCD/SVCD:

1. "Select track"
2. Select the desired track.

## Selecting the camera angle\*

The availability of a different camera angle depends on the DVD and the current DVD track.

1. Turn the controller during playback.
2. Open "Options".
3. "Additional options"
4. "Viewing angle"
5. Select the desired camera angle.

## Opening the main menu, back

These functions are not contained on every DVD. Therefore, they may not be available for use.

## DVD changer\*

### Above the glove compartment



Press the button.

The cover opens automatically.

To close: press the cover closed.

## Controls and displays

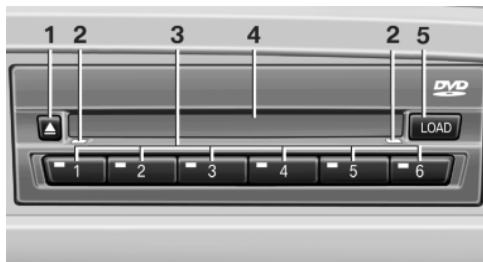

- 1 Empty DVD compartments
- 2 LED on DVD slot
- 3 Buttons for DVD compartments
- 4 DVD slot
- 5 Fill DVD compartments

## Filling the DVD compartments individually

1.  Press the button.  
The LED on the first empty compartment flashes.
2. Select another compartment if necessary.
3. Wait for the LEDs on the DVD slot to flash.
4. Insert a single CD or DVD in the middle.  
The CD/DVD is drawn in automatically and placed into the selected compartment.

-  Sliding in CDs/DVDs  
Do not insert the CD/DVD until the LEDs on the DVD slot are flashing; otherwise, the CD/DVD or the DVD changer could be damaged. Do not continue to push on the CD/DVD; this may cause it to jam and prevent it from being able to eject again. ◀

## Filling all empty DVD compartments

1.  Hold the button down.  
The LEDs on the empty CD compartments flash.
2. Wait for the LEDs on the DVD slot to flash and then insert a CD or DVD into the center.

The CDs/DVDs are drawn in automatically and placed into the vacant compartments.



Sliding in CDs/DVDs

Do not insert the CD/DVD until the LEDs on the DVD slot are flashing; otherwise, the CD/DVD or the DVD changer could be damaged.

Do not continue to push on the CD/DVD; this may cause it to jam and prevent it from being able to eject again. ◀

After they are inserted, it may take several minutes for the CDs/DVDs to be read in.

### Removing a single CD/DVD



1. Press the button.

2. Select the DVD compartment.

The CD/DVD is partially ejected.

3. Remove the CD/DVD.

### Removing all CDs/DVDs



1. Hold the button down.

2. Remove the CDs/DVDs.

### Malfunctions

If all LEDs on the DVD changer are flashing rapidly, a malfunction has occurred.

To eliminate the malfunction:

1. Press one of the buttons:



The CD/DVD last inserted is ejected.

2. Remove the CD/DVD.

The DVD changer is functional again after the LEDs stop flashing rapidly.

### Notes

#### CD/DVD player and changer



Do not remove the cover

BMW CD/DVD players and changers are officially designated Class 1 laser products. Do

not operate if the cover is damaged; otherwise, severe eye damage may occur. ◀

### CDs and DVDs



Use of CDs/DVDs

▶ Do not use self-recorded CDs/DVDs with labels applied, as these can become detached during playback due to heat buildup and can cause irreparable damage to the device.

▶ Only use round CDs/DVDs with a standard diameter of 4.7 in/12 cm and do not play CDs/DVDs with an adapter, e.g., single CDs; otherwise, the CDs or the adapter may jam and no longer eject.

▶ Do not use combined CDs/DVDs, e.g., DVD Plus, as the CDs/DVDs can jam and will no longer eject. ◀

### General malfunctions

▶ Rolls-Royce CD/DVD changers and players have been optimized for performance in vehicles. In some instances they may be more sensitive to faulty CDs/DVDs than stationary devices would be.

▶ If a CD/DVD cannot be played, first check whether it has been inserted correctly.

### Humidity

High levels of humidity can lead to condensation on the CD/DVD or the laser's scan lens, and temporarily prevent playback.

### Malfunctions involving individual CDs/DVDs

If malfunctions occur only with particular CDs/DVDs, this can be due to one of the following causes:

#### Home-recorded CDs/DVDs

▶ Possible reasons for malfunctions with home-recorded CDs/DVDs are inconsistent data creation or recording processes, or poor quality or old age of the blank CD/DVD.

▶ Only label CDs/DVDs on the upper side with a pen intended for this purpose.



## Damage

- ▶ Avoid fingerprints, dust, scratches and moisture.
- ▶ Store CDs/DVDs in a sleeve.
- ▶ Do not subject CDs/DVDs to temperatures over 122 °F/50 °C, high humidity or direct sunlight.

## CDs/DVDs with copy protection

CDs/DVDs are often provided with a copy protection feature by the manufacturer. This can mean that some CDs/DVDs cannot be played or can only be played to a limited extent.

## MACROVISION

This product contains copyrighted technology that is based on multiple registered US patents and the intellectual property of the Macrovision Corporation and other manufacturers. The use of this copy protection must be approved by Macrovision. Media protected by this product - unless otherwise agreed with Macrovision - may only be used for private purposes. Copying of this technology is prohibited.

# Music collection\*

## Storing music

### General information

Music tracks from CDs/DVDs and USB devices can be stored in the music collection on a hard disk in the vehicle and played from there.

- ▶ Audio CD: tracks are converted into a compressed audio format. If available, information on the album, such as the artist, is stored as well.
- ▶ CD/DVD or USB device with compressed audio files: the entire content of the CD/DVD or the USB device is stored in the vehicle as an album. The WMA, MP3, and AAC formats are stored. Individual tracks and directories can be deleted later, [Deleting a track and directory, refer to page 188](#).

Tracks with DRM copy protection can be stored but cannot be played back.



### Backing up music data

Regularly back up the music data; otherwise, it could be lost if there is a fault on the hard disk. ◀



Music recognition technology and related data are provided by Gracenote®. Gracenote is the industry standard in music recognition technology and related content delivery. For more information, please visit [www.gracenote.com](http://www.gracenote.com).

CD and music-related data from Gracenote, Inc., copyright © 2000-2009 Gracenote. Gracenote Software, copyright © 2000-2009 Gracenote. This product and service may practice one or more of the following U.S. Patents: #5,987,525; #6,061,680; #6,154,773, #6,161,132, #6,230,192, #6,230,207, #6,240,459, #6,330,593, and other patents issued or pending. Some services supplied under license from Open Globe, Inc. for U.S. Patent: #6,304,523.

## Storing from a CD/DVD

1. Insert a CD or DVD into the CD/DVD player.
2. "CD/Multimedia"
3. "CD/DVD"
4. Select the symbol for the CD/DVD player.
5. "Store in vehicle"

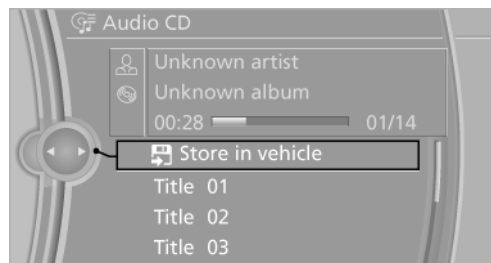

The music collection is displayed and the first track of the CD/DVD is played back. During the storage process, the tracks are played in sequence.

Observe the following during the storage process:

Do not switch to the CD/DVD player and do not remove the CD/DVD from the CD/DVD player as this will interrupt the storage process. You can switch to the other audio sources without interrupting the storage process. Tracks from the current CD/DVD that have already been stored can be called up.

### Interrupting storage

1. "CD/Multimedia"
2. "CD/DVD"
3. "Storing..."



4. "Cancel storing"

The storage process is interrupted and can be continued at any time.

### Continuing the storage process

1. "CD/Multimedia"
2. "CD/DVD"
3. Select the symbol for the CD/DVD player.
4. "Continue storing"

Storage of the CD/DVD continues at the beginning of the track at which storage was interrupted.

### Album information

During storage, information such as the name of the artist is stored with the track, if this information is available in the vehicle database or on the CD.

### Storing from a USB device

To store music, a suitable device must be connected to the USB interface in the glove compartment.

- ▶ Suitable devices: USB mass storage devices, such as USB flash drives or MP3 players with a USB interface.
- ▶ Unsuitable devices: USB hard disks, USB hubs, USB memory card readers with multiple inserts, Apple iPod/iPhone. Music from the Apple iPod/iPhone can be played via the USB audio interface in the center armrest.

1. Connect the USB device to the **USB interface in the glove compartment**, refer to [page 139](#).
2. "CD/Multimedia"
3. "Music collection"
4. Open "Options".
5. "Music data import/export"
6. "Import music (USB)"

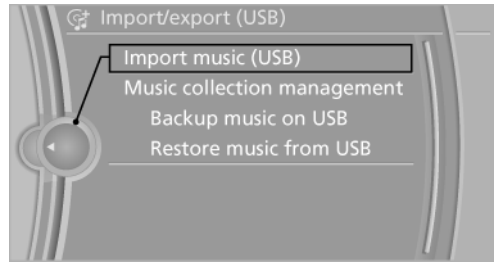

### Playing music

#### Music search

All tracks for which additional information has been stored can be accessed by the music search. Tracks without additional information can be called up via the corresponding [album](#), refer to [page 187](#).

1. "CD/Multimedia"
2. "Music collection"

### 3. "Music search"

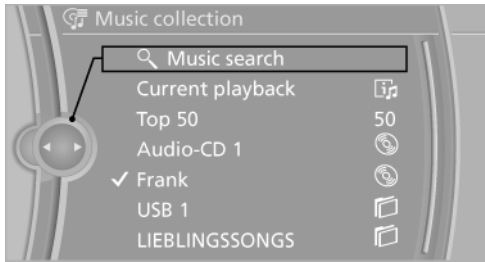

#### 4. Select the desired category.



#### 5. Select the desired entry.

- ▶ Select "A-Z search", refer to page 24, and input the desired entry.
- ▶ Select the desired entry from the list.

#### 6. Select other categories if you wish.

The tracks found are listed in alphabetical order.

Not all categories need to be selected. For example, to search for all tracks by a certain artist, call up that artist only. All of the tracks by that artist are then displayed.

#### 7. "Start play"

The list of tracks is repeated automatically.

### Restarting the music search

"New search"

### Current playback

List of tracks that was generated last by the music search or the album selected last.

1. "CD/Multimedia"
2. "Music collection"

### 3. "Current playback"



#### 4. Select the desired track, if necessary.



### Top 50

The 50 most frequently played tracks.

1. "CD/Multimedia"
2. "Music collection"
3. "Top 50"
4. Select the desired track, if necessary.

### Albums

All stored albums, listed in order of their storage dates.

Symbol	Format
	Audio CD
	Compressed audio files

1. "CD/Multimedia"
2. "Music collection"
3. Select the desired album.

Depending on the album, the tracks or the subdirectories of the album are displayed. The first track is played automatically, if possible.

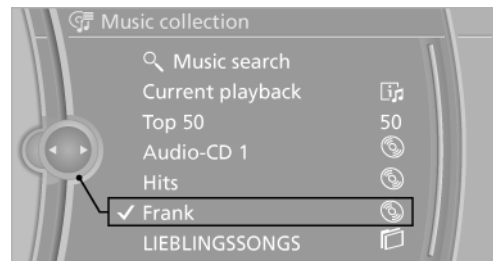

4. Change directories if needed to select tracks.

To go up a level in the directory: move the controller to the left.

### Random playback

All tracks of the selection are played back in random order.

1. "CD/Multimedia"
2. "Music collection"
3. Open "Options".
4. "Random"

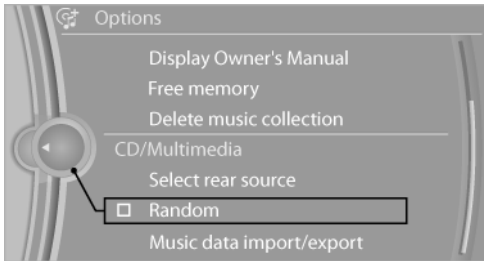

## Managing music

### Albums

#### Renaming an album\*

The name of the album, if available, is automatically entered when the album is stored. If the name is unknown it can be changed later if needed.

1. "CD/Multimedia"
2. "Music collection"
3. Highlight the desired album.
4. Open "Options".

5. "Rename album"

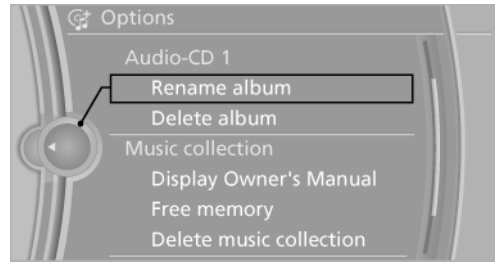

6. Select the letters individually.

#### Deleting an album

An album cannot be deleted while a track from that album is being played.

1. "CD/Multimedia"
2. "Music collection"
3. Highlight the desired album.
4. Open "Options".
5. "Delete album"

#### Deleting a track and directory

A track cannot be deleted while it is being played.

A directory cannot be deleted while a track from that directory is being played.

1. "CD/Multimedia"
2. "Music collection"
3. Highlight the directory or track.
4. Open "Options".
5. "Delete folder" or "Delete track"

#### Free memory capacity

Display the free memory capacity in the music collection.

1. "CD/Multimedia"
2. "Music collection"
3. Open "Options".
4. "Free memory"

## Music collection

### Backing up the music collection

The entire music collection can be stored on a USB device. Make sure there is enough free memory capacity on the USB device.

Depending on the number of tracks, backing up the music collection may take several hours.

Therefore, it is best to perform the backup during a long trip.

1. Starting the engine.
2. Connect the USB device to the **USB interface in the glove compartment**, refer to [page 139](#).
3. "CD/Multimedia"
4. "Music collection"
5. Open "Options".
6. "Music data import/export"

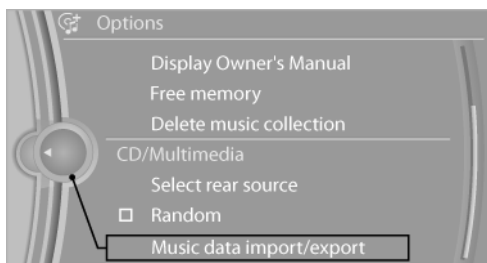

7. "Backup music on USB"

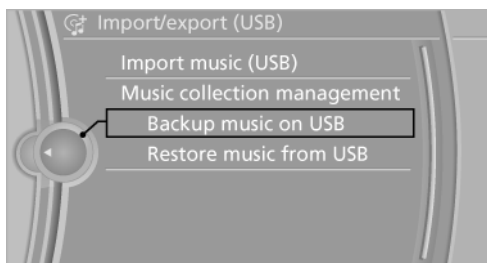

### Storing the music collection in the vehicle

When storing from the USB device, the existing music collection in the vehicle is replaced.

1. "CD/Multimedia"
2. "Music collection"

3. Open "Options".
4. "Music data import/export"
5. "Restore music from USB"

### Deleting the music collection

1. "CD/Multimedia"
2. "Music collection"
3. Open "Options".
4. "Delete music collection"

## External devices

### At a glance

Symbol	Meaning
	AUX-IN port
	USB audio interface*/mobile phone audio interface*
	Rear AUX-IN port*
	Rear AUX-IN port on the right*

### AUX-IN port

#### At a glance

- ▶ For connecting audio devices, e.g., MP3 player. The sound is played back on the vehicle loudspeakers.
- ▶ Recommendation: use medium tone and volume settings on the audio device. The tone depends on the quality of the audio files.

### Connecting

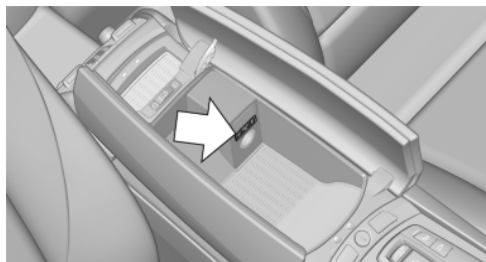

The AUX-IN port is in the center armrest.

Connect the headphones or line-out connector of the device to the jack plug.

### Playback

1. Connect the audio device, switch it on and select a track on the audio device.
2. "CD/Multimedia"
3. If necessary, "External devices"
4.  "AUX front"

### Volume

The volume of the sound output is dependent on the audio device. If this volume differs markedly from the volume of the other audio sources, it is advisable to adjust the volumes.

### Adjusting the volume

1. "CD/Multimedia"
2. If necessary, "External devices"
3.  "AUX front"
4. "Volume"

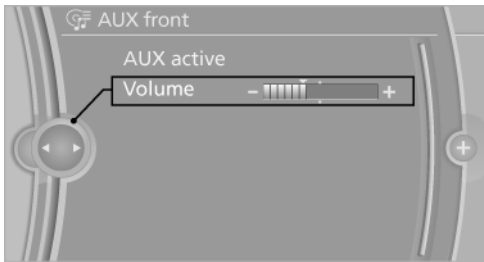

5. Turn the controller until the desired volume is set and press the controller.

### USB audio interface\*/mobile phone audio interface\*

#### At a glance

It is possible to connect external audio devices. Operation takes place on the iDrive. The sound is played back on the vehicle loudspeakers.

### Connectors for external devices

- ▷ Connection via USB audio interface: Apple iPod/iPhone, USB devices, e.g., MP3 players, USB flash drives, or mobile phones that are supported by the USB audio interface.
- ▷ Connection via [snap-in adapter](#), refer to [page 212](#), when equipped with extended connectivity of the music player in the mobile phone: Apple iPhone or mobile phones. Playback is only possible if no connector is plugged into the USB audio interface.

Due to the large number of different audio devices available on the market, it cannot be ensured that every audio device/mobile phone is operable on the vehicle.

Ask your service center about suitable audio devices/mobile phones.

### Audio files

Standard audio files can be played back:

- ▷ MP3.
- ▷ WMA.
- ▷ WAV (PCM).
- ▷ AAC.
- ▷ Playback lists, M3U.

### Connection of Apple iPod/iPhone via USB audio interface

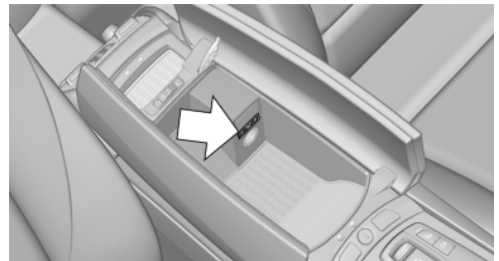

The USB audio interface is in the center armrest.

Use it to connect the special cable adapter for the Apple iPod/iPhone, available from your service center. The cable adapter is required for a good connection.



Use the cable adapter for the Apple iPod/iPhone to connect the Apple iPod/iPhone with the AUX-IN port and the USB interface.

The Apple iPod/iPhone menu structure is supported by the USB audio interface.

### Connection of a USB device via the USB audio interface

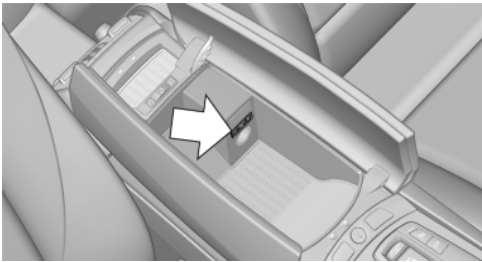

The USB audio interface is in the center armrest. Connect using a flexible adapter cable to protect the USB audio interface and the USB device against physical damage.



Connect the USB device to the USB interface.

### After connecting for the first time

Information on all tracks (e.g., artist, genre) and the playback lists are transferred to the vehicle.

This may take some time, depending on the USB device and the number of tracks.

During transmission, the tracks can be called up via the file directory.

### Number of tracks

Information from up to four USB devices or for approx. 16,000 tracks can be stored in the vehicle. If a fifth device is connected or if more than 16,000 tracks are stored, information on existing tracks may be deleted.

### Copy protection

Music tracks with integrated Digital Rights Management (DRM) cannot be played.

### Playback

1. "CD/Multimedia"
2. "External devices"
3.  Select the symbol.



The playback starts with the first track.

When an Apple iPhone is connected via the snap-in adapter and an audio device is connected to the AUX-IN port at the same time, the audio signal of the AUX-IN port is played.

### Track search

Selection is possible via:

- ▶ Playback lists, M3U.
- ▶ Information: type of music, artist, album, track.
- ▶ Additionally for USB devices: file directory, composer.

Tracks are displayed if they have been saved in the Latin alphabet.

### Starting the track search

1. "CD/Multimedia"
2. "External devices"
3.  Select the symbol.
4. Select the desired category, e.g., "Genre" or "Artist".

All entries are displayed in a list.

- ▷ Open "A-Z search" and input the desired entry. When a letter is entered, the results are filtered using this letter as the first letter. If multiple letters are entered, all results that contain that sequence are displayed.
- ▷ Select the desired entry from the list.

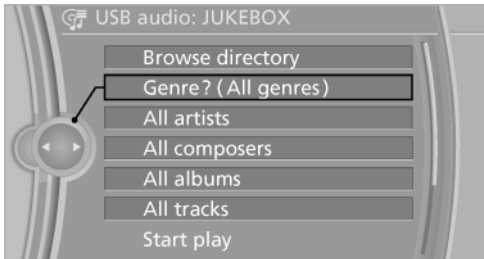

5. Select other categories if you wish.  
Not all categories need to be selected. For example, if all of the tracks by a certain artist are to be displayed, call up that artist only. All of the tracks by that artist are then displayed.
6. "Start play"

### Restarting a track search

"New search"

### Playback lists

Opening playback lists, M3U.

1. "CD/Multimedia"
2. "External devices"
3.  Select the symbol.
4. "Playlists"

### Current playback

List of tracks currently being played.

1. "CD/Multimedia"
2. "External devices"
3.  Select the symbol.
4. "Current playback"

### Random playback

The current list of tracks is played back in random order.

1. "CD/Multimedia"
2. "External devices"
3. Open "Options".
4. "Random"

### Fast forward/reverse



Press and hold the button for the corresponding direction.

### Notes

Do not expose the audio device to extreme environmental conditions, such as very high temperatures; refer to the audio device operating instructions.

Depending on the configuration of the audio files, e.g., bit rates greater than 256 kbit/s, the files may not play back correctly in each case.

### Information on connection

- ▷ The connected audio device is supplied with max. 500 mA current if this is supported by the device. Therefore, do not connect the device to the power socket in the vehicle.
- ▷ Do not use force when plugging the connector into the USB interface.
- ▷ Do not connect devices such as fans or lamps to the USB audio interface.
- ▷ Do not connect USB hard drives.
- ▷ Do not use the audio interface to recharge external devices.



# Rear entertainment\*

## Controls

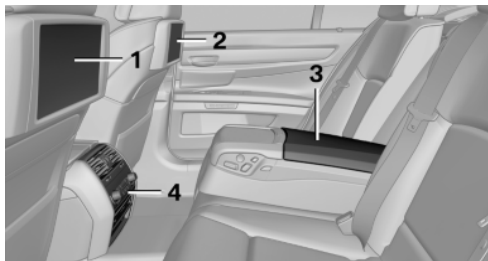

- 1 Screen, left
- 2 Screen, right
- 3 Center armrest, remote control
- 4 CD/DVD player

## Rear CD/DVD player

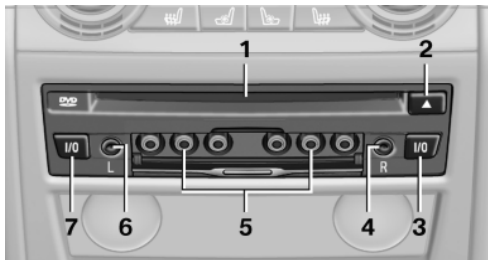

- 1 CD/DVD slot
- 2 Eject CD/DVD
- 3 On/off, right
- 4 Headphone connection, right
- 5 RCA sockets
- 6 Headphone connection, left
- 7 On/off, left

## Switching the system on/off

 Press the left or right side of the button on the CD/DVD player in the rear for the respective page.

Rear entertainment and screens are switched on/off.

## Screens

### Adjusting



Danger of burns when screen is folded out. Do not reach behind the screen; otherwise, there is the danger of getting burned. The back of the screen can become very hot. ◀

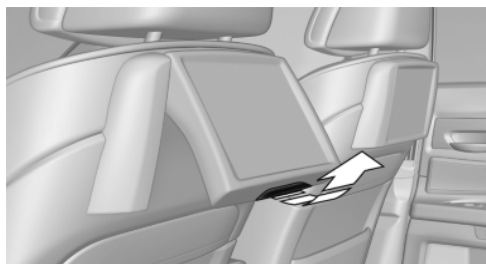

- ▷ To fold out: pull at the bottom edge.
- ▷ To fold in: press against the bottom edge.

### Notes

- ▷ Do not cover or apply stickers to the bottom edge of the screen because this is where the sensors and infrared interface are installed.
- ▷ When loading the rear seats and adjusting the backrest of the front seat, fold in the screens.
- ▷ When cleaning the screen, follow the [care instructions](#), refer to [page 252](#).

## Remote control

### In the center armrest in the rear

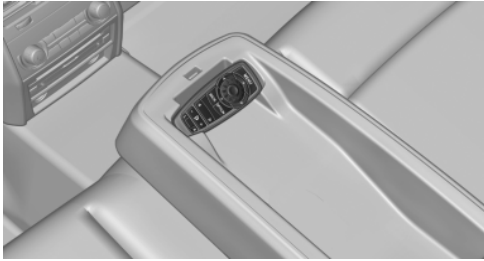

Storage is possible in a vertical or horizontal position in the center armrest.

### Menu navigation

Press the button    Function



Turn the wheel: highlight a menu item.

Press the center knob: confirm the selection.

Press the arrow buttons: change between panels.



Opens the main menu.



Displays the previous menu.



Opens the "Options" menu.



Changes the station, track or chapter.

Press and hold the button: fast forward/reverse.



Adjusts the volume.



Switches the volume adjustment to the left/right.

The transmission time of the remote control is limited by law. To execute a function again, press or turn the required button again.

## Replacing the batteries



No rechargeable batteries

Do not use rechargeable batteries as damage may result from the substances in the batteries. ◀

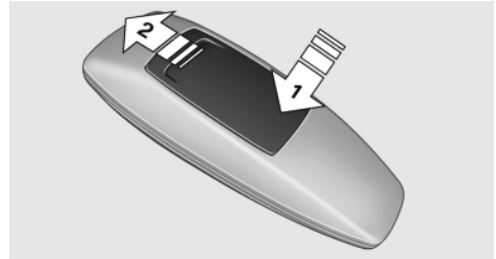

1. Remove the cover. Press on the cover, arrow 1, and push forward, arrow 2.
2. Insert batteries of the same type.
3. Close the cover.



Take the used battery to a recycling center or to your service center.

## Controls

Almost all functions can be operated in the same manner as they are in the front. Special features of operating the system in the rear are described here.

### Audio/video playback

#### Audio

Audio can be played back via rear entertainment from any source in the vehicle.

Operation is the same as for the [front audio playback](#), refer to page 179.

#### Video

Video can be played back in the rear from the following sources:

- ▶ DVD changer\*.
- ▶ Rear CD/DVD player.
- ▶ External device in rear.

If a video image is being played back in the rear, the rear source cannot be selected in the front.

Operation is the same as for the [front video playback](#), refer to page 181.

## Radio

When the same radio source is selected in the front and rear (e.g., FM/AM), the same radio station is played.

Operation is the same as for the [front radio](#), refer to page 172.

## CD/multimedia

### CD/DVD

When the same audio source (front CD/DVD player, rear CD/DVD player, DVD changer) is selected in the front and rear, the same material is played.

Operation is the same as for the [front CD/DVD](#), refer to page 179.

Notes on CDs/DVDs, refer to page 184.

### Music collection\*

Music can only be stored and data can only be exported and imported via the front CD/DVD player or the USB interface in the glove compartment.

When music collections are selected in the front and rear, they are played back separately.

Operation is the same as for the [front music collection](#), refer to page 185.

## Tone

Only treble and bass can be set in the rear. The settings are made separately for the left and right headphones.

Operation is the same as for the [front tone](#), refer to page 170.

## Adjusting

The following settings are available:

- ▷ "Rear displays"

- ▷ "Language/Units": language can be set globally for all screens.
- ▷ "Tone"

## Options menu

The split screen is not available and there is no integrated Owner's Manual.

Operation is the same as for the [front menu options](#), refer to page 21.

## Enabling

### Enabling operation in the rear

Only possible via the iDrive in the front.

1. "Settings"
2. "Allow rear control"
3. Select the desired priority.

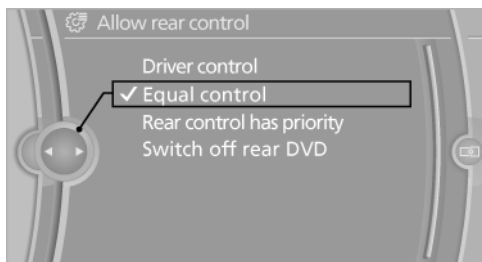

## Priority options

### The driver has priority

- ▷ The source selected in the front via the iDrive is played on the vehicle loudspeakers and can be selected but not changed in the rear. Other audio or video sources can be operated as well.
- ▷ Sound can only be output in the rear via headphones.
- ▷ The source that is to be displayed in the rear can be set via the iDrive in the front.

To set the source in the rear via the iDrive in the front:

1. Open "Options".

2. "Select rear source"
3. Select the desired audio or video source.

### Same priority

- ▷ All audio and video sources can be operated via the iDrive in the front and rear.
- ▷ Sound is output in the rear via headphones: the source selected via the iDrive in the front is output on the vehicle loudspeakers.
- ▷ Sound is output via loudspeakers: the source selected last via the iDrive in the front or rear is output via the vehicle loudspeakers.

### The rear has priority

- ▷ When the source selected in the rear is played on headphones, it can be selected but not changed via the iDrive in the front. Other audio or video sources can be operated as well.
- ▷ Sound is output in the rear via headphones: the source selected via the iDrive in the front is output on the vehicle loudspeakers.
- ▷ Sound is output via loudspeakers: the source selected in the rear is output on the vehicle loudspeakers. Audio or video sources cannot be selected via the iDrive in the front.

### Switching off the rear DVD

- ▷ Rear entertainment is switched off.
- ▷ To switch rear entertainment back on: select a different priority via the iDrive in the front and [switch on the system, refer to page 193](#).

## Headphones, vehicle loudspeakers

### Connecting the headphones

#### Normal headphones

Connect via the [jack 1/8"/3.5 mm, refer to page 193](#), on the rear CD/DVD player.

### Infrared headphones

Connection via the infrared interface on the lower edge of the screen.

Fitting infrared headphones and information on which headphones are supported can be obtained from your service center.

When using infrared headphones, ensure that the connection between the headphones and the infrared interface is not disrupted:

- ▷ Do not place an obstacle between the interface and headphones.
- ▷ Do not cover the interface.
- ▷ Do not scratch the interface.

Unfavorable light conditions such as bright ambient light can impair reception.

### Sound output on the headphones or vehicle loudspeakers

Operation is only possible in the rear.

1. Open "Options".
2. "Headphones" or "Loudspeakers"

The "Loudspeakers" function is not available with the "Driver control" setting.

## External devices

### General information

External audio and video devices and digital cameras can be connected to [cinch sockets, refer to page 193](#), on the CD/DVD player. Operation takes place on the external device.



Due to the large number of different audio and video devices available on the market, it cannot be ensured that every audio and video device will be displayed correctly on the screen.

### Connecting an external device

1. Fold down the cover in front of the cinch sockets on the CD/DVD player.
2. Connect the external device to the RCA sockets.
  - ▷ Video: yellow socket.

- ▶ Audio: white and red socket.

## Starting playback

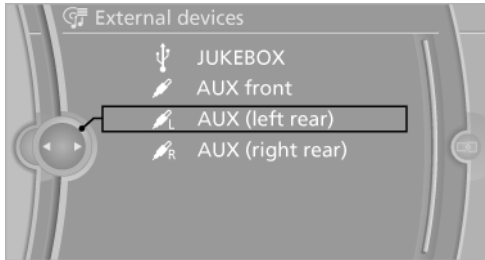

1. "CD/Multimedia"
2. "External devices"
3. Select  or .



## Volume

The volume of the sound output is dependent on the external device. If this volume differs markedly from the volume of the other audio/video sources, it is advisable to adjust the volumes.

## Adjusting the volume

1. "CD/Multimedia"
2. "External devices"
3. Select  or .
4. "Volume"

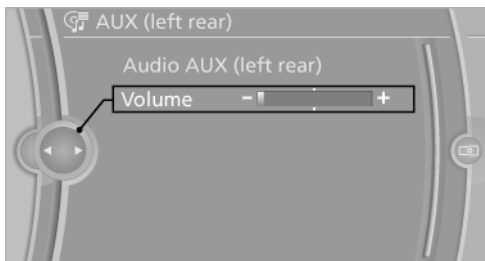

5. Turn the controller until the desired volume is set and press the controller.

# Professional rear entertainment\*

## Controls

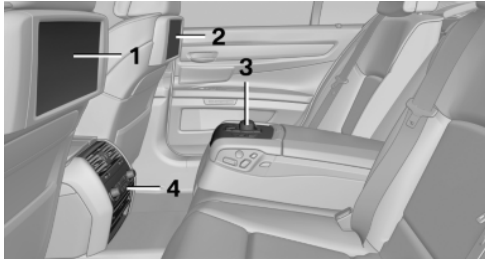

- 1 Screen, left
- 2 Screen, right
- 3 Controller with buttons
- 4 CD/DVD player

## Rear CD/DVD player

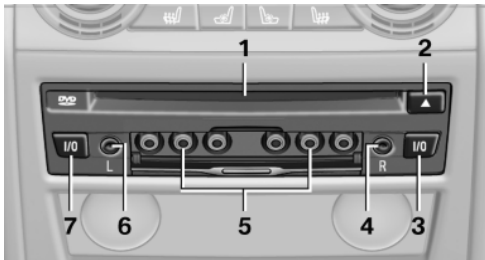

- 1 CD/DVD slot
- 2 Eject CD/DVD
- 3 On/off, right
- 4 Headphone connection, right
- 5 RCA sockets
- 6 Headphone connection, left
- 7 On/off, left

## Switching the system on/off

 Press the left or right side of the button on the CD/DVD player in the rear for the respective page.

Rear entertainment and screens are switched on/off.

## Screens

### Adjusting

 Danger of burns when screen is folded out  
Do not reach behind the screen; otherwise, there is the danger of getting burned. The back of the screen can become very hot. ◀

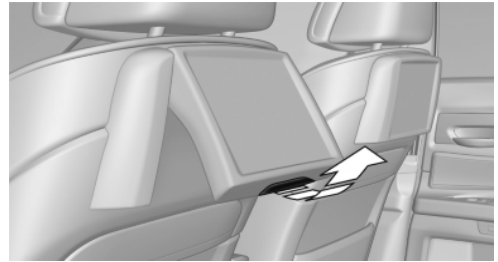

- ▷ To fold out: pull at the bottom edge.
- ▷ To fold in: press against the bottom edge.

### Notes

- ▷ Do not cover or apply stickers to the bottom edge of the screen because this is where the sensors and infrared interface are installed.
- ▷ When loading the rear seats and adjusting the backrest of the front seat, fold in the screens.
- ▷ When cleaning the screen, follow the [care instructions](#), refer to page 252.

## iDrive in the rear

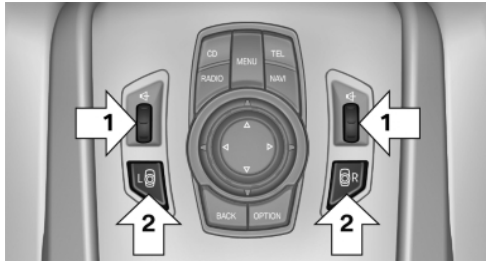

Operation is the same as for the [iDrive in the front](#), refer to page 19.

- ▶ To adjust the volume: turn the thumb wheel, arrows 1.
- ▶ To activate the controller and switch between the screens: press the buttons, arrows 2.

A green LED indicates which screen is active and can be operated via the iDrive in the rear.

## Controls

Almost all functions can be operated in the same manner as they are in the front. Special features of operating the system in the rear are described here.

### Audio/video playback

#### Audio

Audio can be played back via rear entertainment from any source in the vehicle.

Operation is the same as for the [front audio playback](#), refer to page 179.

#### Video

Video can be played back in the rear from the following sources:

- ▶ DVD changer\*.
- ▶ Rear CD/DVD player.
- ▶ External device in rear.

Operation is the same as for the [front video playback](#), refer to page 181.

## Radio

When the same radio source is selected in the front and rear (e.g., FM/AM), the same radio station is played.

Operation is the same as for the [front radio](#), refer to page 172.

## CD/multimedia

### CD/DVD

When the same audio source (front CD/DVD player, rear CD/DVD player, DVD changer) is selected in the front and rear, the same material is played.

Operation is the same as for the [front CD/DVD](#), refer to page 179.

[Notes on CDs/DVDs](#), refer to page 184.

### Music collection\*

Music can only be stored and data can only be exported and imported via the front CD/DVD player or the USB interface in the glove compartment.

When music collections are selected in the front and rear, they are played back separately.

Operation is the same as for the [front music collection](#), refer to page 185.

### Tone

Only treble and bass can be set in the rear for headphones. The settings are made separately for the left and right headphones.

Operation is the same as for the [front tone](#), refer to page 170.

### Navigation\*

Route planning can be performed separately on the left and right sides in the rear. Destination guidance can only be started from the front.

Operation is the same as for the [front navigation](#), refer to page 154.

### Suggesting a destination

A destination or trip can be sent to the front as a suggestion. The suggestion can be adopted,

stored, or declined in the front. This function is not available with the following setting: "Driver control".

1. Enter the destination.
2. "Suggest destination"

## Contacts

Operation is the same as for the [front contacts](#), refer to page 214.

## BMW Assist

Operation is the same as for [BMW Assist in the front](#), refer to page 216.

## Adjusting

The following settings are available:

- ▷ "Rear display"
- ▷ "Language/Units": language can be set globally for all screens.
- ▷ "Tone"
- ▷ "Climate"

## Vehicle information

Computer content can be displayed. Operation is only possible in the front.

## Options menu

The split screen is not available and there is no integrated Owner's Manual.

Operation is the same as for the [front menu options](#), refer to page 21.

## Enabling

### Enabling operation in the rear

Only possible via the iDrive in the front.

1. "Settings"
2. "Allow rear control"

3. Select the desired priority.

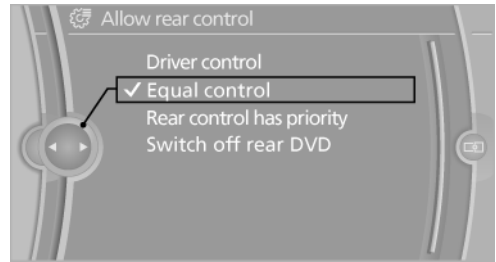

## Priority options

### The driver has priority

- ▷ The source selected in the front via the iDrive is played on the vehicle loudspeakers and can be selected but not changed in the rear. Other audio or video sources can be operated as well.
- ▷ Sound can only be output in the rear via headphones.
- ▷ The source that is to be displayed in the rear can be set via the iDrive in the front.

To set the source in the rear via the iDrive in the front:

1. Open "Options".
2. "Select rear source"
3. Select the desired audio or video source.

### Same priority

- ▷ All audio and video sources can be operated via the iDrive in the front and rear.
- ▷ Sound is output in the rear via headphones: the source selected via the iDrive in the front is output on the vehicle loudspeakers.
- ▷ Sound is output via loudspeakers: the source selected last via the iDrive in the front or rear is output via the vehicle loudspeakers.

### The rear has priority

- ▷ When the source selected in the rear is played on headphones, it can be selected but not changed via the iDrive in the front.



Other audio or video sources can be operated as well.

- ▷ Sound is output in the rear via headphones: the source selected via the iDrive in the front is output on the vehicle loudspeakers.
- ▷ Sound is output via loudspeakers: the source selected in the rear is output on the vehicle loudspeakers. Audio or video sources cannot be selected via the iDrive in the front.

## Switching off the rear DVD

- ▷ Rear entertainment is switched off.
- ▷ To switch rear entertainment back on: select a different priority via the iDrive in the front and [switch on the system, refer to page 198](#).

# Headphones, vehicle loudspeakers

## Connecting the headphones

### Normal headphones

Connect via the [jack 1/8"/3.5 mm, refer to page 198](#), on the rear CD/DVD player.

### Infrared headphones

Connection via the infrared interface on the lower edge of the screen.

Fitting infrared headphones and information on which headphones are supported can be obtained from your service center.

When using infrared headphones, ensure that the connection between the headphones and the infrared interface is not disrupted:

- ▷ Do not place an obstacle between the interface and headphones.
- ▷ Do not cover the interface.
- ▷ Do not scratch the interface.

Unfavorable light conditions such as bright ambient light can impair reception.

## Sound output on the headphones or vehicle loudspeakers

Operation is only possible in the rear.

1. Open "Options".
2. "Headphones" or "Loudspeakers"

The "Loudspeakers" function is not available with the "Driver control" setting.

## External devices

### General information



External audio and video devices and digital cameras can be connected to [cinch sockets, refer to page 198](#), on the CD/DVD player. Operation takes place on the external device.

Due to the large number of different audio and video devices available on the market, it cannot be ensured that every audio and video device will be displayed correctly on the screen.

### Connecting an external device

1. Fold down the cover in front of the cinch sockets on the CD/DVD player.
2. Connect the external device to the RCA sockets.
  - ▷ Video: yellow socket.
  - ▷ Audio: white and red socket.

### Starting playback

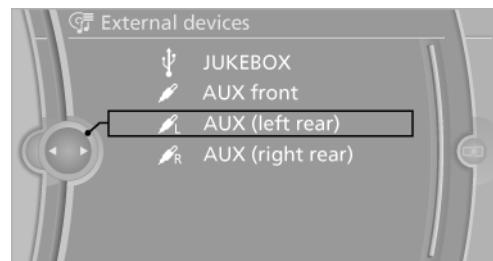

1. "CD/Multimedia"
2. "External devices"
3. Select  L or  R .



## Volume

The volume of the sound output is dependent on the external device. If this volume differs markedly from the volume of the other audio/video sources, it is advisable to adjust the volumes.

### Adjusting the volume

1. "CD/Multimedia"
2. "External devices"
3. Select  or .
4. "Volume"

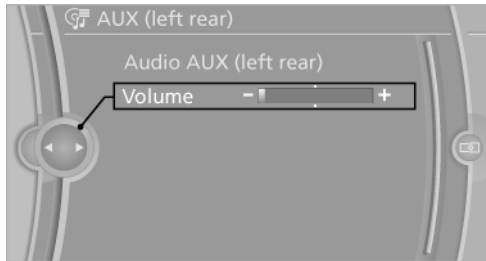

5. Turn the controller until the desired volume is set and press the controller.





## Communication

All of the options available to you for mobile communication with family, friends, business partners, and service providers are described in this chapter.

# Telephone\*

## At a glance

### The concept

After the mobile phone is paired once with the vehicle, the mobile phone can be operated using the iDrive, the steering wheel buttons and spoken instructions. A paired mobile phone is automatically detected as soon as it is located inside the vehicle, when the ignition is switched on.

Up to four mobile phones can be paired.



Using the mobile phone while driving

Make entries only when traffic and road conditions allow. Do not hold the mobile phone in your hand while you are driving; use the hands-free system instead. If you do not observe this precaution, you can endanger the vehicle occupants and other road users. ◀

### Snap-in adapter\*

The snap-in adapter is used to:

- ▷ Hold the mobile phone.
- ▷ Recharge the battery.
- ▷ Connect the mobile phone to an outside antenna of the vehicle.

This provides for better network reception and consistent sound quality.

### Approved mobile phones

Inquire with your BMW center which mobile phones containing a Bluetooth interface are supported by the mobile phone preparation package. Additional information can be found at [www.bmw.com/bluetooth](http://www.bmw.com/bluetooth).

These approved mobile phones with a certain software version, support the vehicle functions described below.

Malfunctions can occur with other mobile phones.

Do not operate a mobile phone that has been detected by the vehicle on the keypad of the mobile phone, as this may lead to a malfunction.

## Pairing/unpairing the mobile phone

### Requirements

- ▷ The mobile phone is suitable.
- ▷ The mobile phone is ready for operation.
- ▷ **Bluetooth is activated in the vehicle, refer to page 207**, and on the mobile phone.
- ▷ Bluetooth presettings must be made on the mobile phone, e.g., for a connection without confirmation or visibility; refer to the mobile phone operating instructions.
- ▷ A number with at least four and a maximum of 16 digits is defined as the Bluetooth passkey. It is only required once for pairing.
- ▷ The ignition is switched on.

### Connecting and pairing



Pairing the mobile phone

To avoid becoming distracted and posing an unnecessary hazard both to your own vehicle's occupants and to other road users, only pair the mobile phone while the vehicle is stationary. ◀

Pair the vehicle entirely on the front or rear Control Display.

1. "Telephone"
2. "Bluetooth"
3. "Add new phone"

The Bluetooth name of the vehicle is displayed.

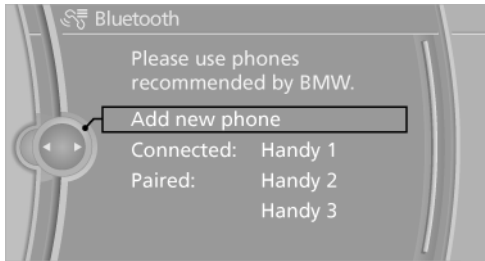

4. To perform additional steps on the mobile phone; refer to the mobile phone operating instructions: e.g., search for or connect the Bluetooth device or a new device.

The Bluetooth name of the vehicle appears on the mobile phone display.

5. Select the Bluetooth name of the vehicle on the mobile phone display.

You are prompted by the iDrive or mobile phone to enter the same Bluetooth passkey.

6. Enter the passkey and confirm.

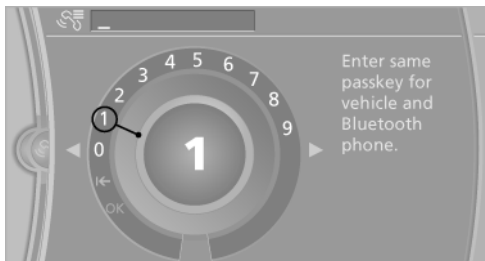

If the pairing was successful, the mobile phone appears at the top of the list of mobile phones.

If pairing was unsuccessful: [what to do if](#), refer to [page 208](#).

### Following the initial pairing

- The mobile phone is detected/connected in the vehicle within 2 minutes if the engine is running or the ignition is switched on.
- After detection, phone book entries from the SIM card and/or mobile phone are transmitted to the vehicle, depending on the mobile phone.

- Four mobile phones can be paired.
- Specific settings may be necessary in some mobile phones, e.g., authorization or a secure connection; refer to the mobile phone operating instructions.

### Activating/deactivating Bluetooth

Bluetooth is not permitted everywhere. Comply with all safety guidelines and regulations.

1. "Telephone"
2. Open "Options".
3. "Bluetooth"

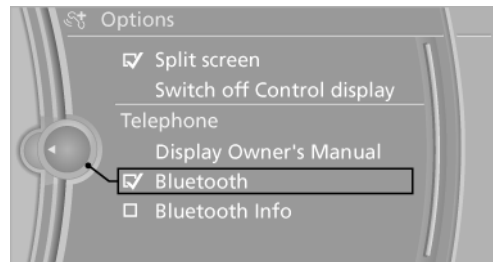

### Connecting a particular mobile phone

If more than one mobile phone is detected by the vehicle, the mobile phone at the top of the list is connected. A different mobile phone can be connected by selecting it.

1. "Telephone"
2. "Bluetooth"
3. Select the mobile phone that is to be connected.

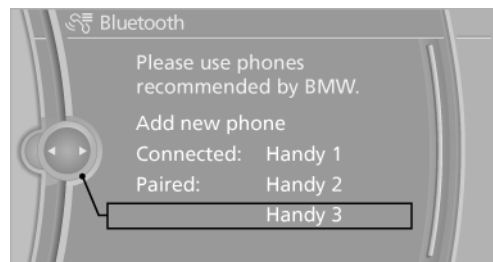

### Unpairing the mobile phone

1. "Telephone"

2. "Bluetooth"  
All paired mobile phones are listed.
3. Highlight the mobile phone that is to be unpaired.
4. Open "Options".
5. "Remove phone from list"

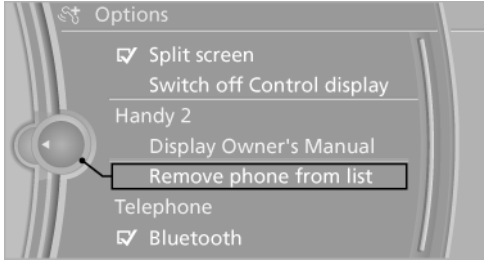

## What to do if...

Not all phone book entries are displayed?

- ▷ Transmission of the phone book entries is not yet complete; note the display in the status field.
- ▷ It may only be possible to transmit the phone book entries on the SIM card\* or the mobile phone.
- ▷ It may not be possible to display phone book entries with special characters.

Was it not possible to pair the mobile phone?

- ▷ Is the mobile phone supported? For information, contact your service center.
- ▷ Do the Bluetooth passkeys on the mobile phone and the vehicle match? Enter the same passkey on the mobile phone and via the iDrive.
- ▷ Did it take longer than 30 seconds to enter the passkey? Repeat the pairing procedure.
- ▷ Are too many Bluetooth devices connected to the mobile phone? If so, delete the connections with other devices on the mobile phone.
- ▷ The mobile phone no longer reacts? Switch the mobile phone off and on again.
- ▷ Repeat the pairing procedure.

- ▷ If all items on the list have been checked and the mobile phone still cannot be paired, please contact Customer Relations.

## Controls

### Incoming call

### Receiving calls

If the number of the caller is stored in the phone book and is transmitted by the network, the name of the contact is displayed.

### Accepting a call

#### Via the button on the steering wheel



Press the button.

#### Via the instrument cluster

"Accept"

#### Via the iDrive

"Accept"

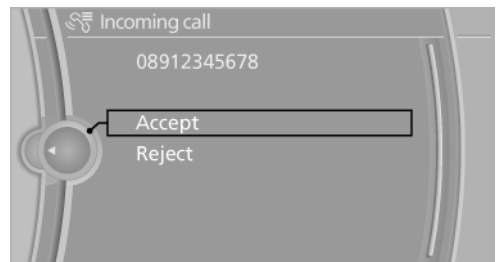

### Rejecting a call

#### Via the instrument cluster

"Reject"

#### Via the iDrive

"Reject"



## Ending a call

### Via the button on the steering wheel



Press the button.

### Via the instrument cluster

"End call"

### Via the iDrive

1. "Telephone"
2. "Active calls"
3. Select an active call.

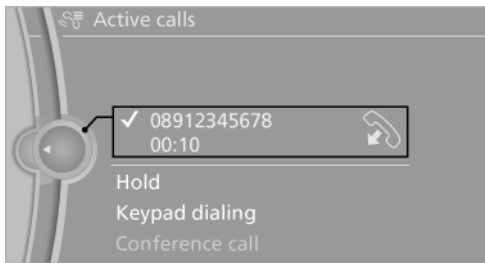

## Entering a phone number

### Dialing a number

1. "Telephone"
2. "Dial number"
3. Select the digits individually.
4.  Select the symbol.

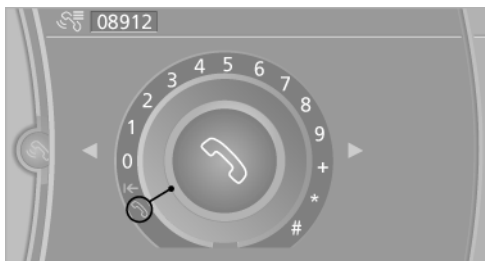

The phone number can also be entered by voice.

## Calls with multiple parties

### General information

You can switch between calls and connect two calls to a single conference call. These functions must be supported by the mobile phone and service provider.

### Accepting a call while speaking to another party

This function may need to be enabled by the service provider and the mobile phone needs to be set up accordingly.

If a second call comes in during an active call, you will hear a call waiting signal.

1. "Accept"

The call is accepted and the existing call is put on hold.

### Establishing a second call

Establish an additional call during an active call.

1. "Telephone"
2. "Active calls"
3. "Hold"

The existing call is put on hold.

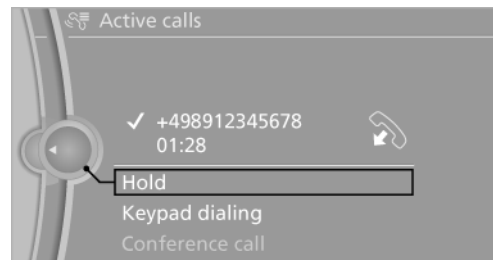

4. Dial the new phone number or select it from a list.

### Switching between two calls, toggling

Active call: indicated by a red handset

Call on hold: indicated by a green handset

To switch to the call on hold, select this handset.

## Establishing a conference call

Two calls can be connected to a single telephone conference call.

1. Establish two calls.
2. "Conference call"

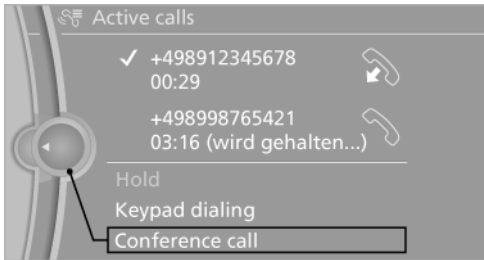

When terminating a conference call, both calls are ended. If one call is terminated by another party, the other call can be continued.

## Phone book

### Displays

The phone book accesses the [contacts](#), refer to [page 214](#), and shows all contacts for which a phone number has been stored. The entries can be selected to make a call.

1. "Telephone"
2. "Phone book"

All contacts with a phone number are displayed. A symbol indicates the storage location of the contacts.

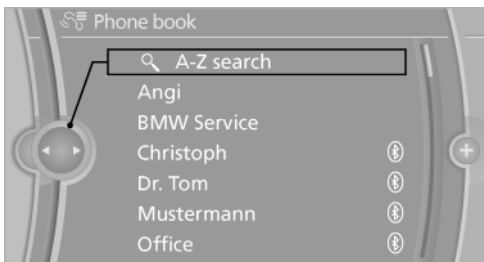

### Calling a contact

1. Select the desired contact.

A connection is established immediately if one is calling contacts with one phone number.

For contacts with several phone numbers:

2. Select the desired phone number.

The connection is established.

### Editing a contact

Change the entries in "Contacts", refer to [page 214](#). When a contact is changed, the changes are not stored on the mobile phone. A copy of the entry is stored in the vehicle.

1. Highlight the contact.
2. Open "Options".
3. "Edit entry"

The contact can be edited.

## Redialing

### General information

The eight phone numbers dialed last are stored.

### Dialing the number via the instrument cluster

This is possible when there is no active call.

1.  Press the button on the steering wheel.

2. Select the desired phone number.

The connection is established.

### Dialing the number via the iDrive

1. "Telephone"
2. "Redial"

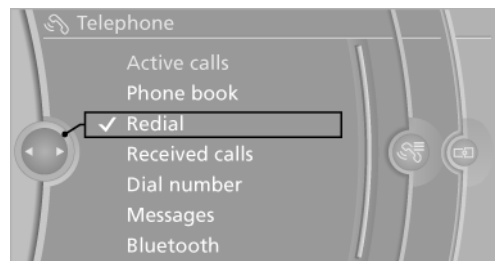

3. Select the desired entry.  
The connection is established.

### Deleting a single entry or all entries

1. Highlight the entry.
2. Open "Options".
3. "Delete entry" or "Delete list"

### Saving an entry in the contacts

1. Highlight the entry.
2. Open "Options".
3. "Store as new contact" or "Add to existing contact"
4. Select the type of number: "Home", "Business", "Mobile" or "Other"
5. Complete the entries if necessary.
6. If necessary, "Store contact".

## Received calls

### Displaying calls

The 20 calls that were last received are displayed.

1. "Telephone"
2. "Received calls"

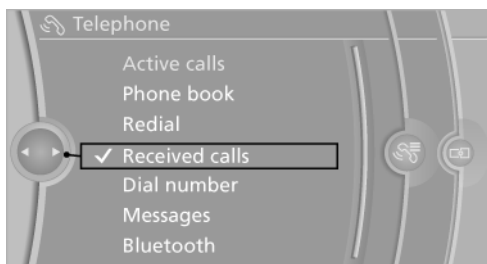

### Calling a number from the list

Select the entry.  
The connection is established.

### Deleting a single entry or all entries

1. Highlight the entry.
2. Open "Options".
3. "Delete entry" or "Delete list"

## Saving an entry in the contacts

1. Highlight the entry.
2. Open "Options".
3. "Store as new contact" or "Add to existing contact"
4. Select the type of number: "Home", "Business", "Mobile" or "Other"
5. Complete the entries if necessary.
6. If necessary, "Store contact".

## Messages

Display of different messages:

- ▶ My Info messages from the BMW Assist portal.
- ▶ [Message from the Concierge service, refer to page 217.](#)

## MyInfo

### Starting destination guidance

1. Select the message that contains the desired destination.
2. Open "Options".
3. "Start guidance" or "Add as another dest."

### Dialing the number in the message

1. Select the message that contains the desired number.
2. Open "Options".
3. "Call"

## Message from the Concierge service

### Using an address in destination guidance

1. Select the message.

2.  "Start guidance" or "Add as another dest."



3. Start destination guidance, if necessary.

### Dialing a phone number

1. Select the message.
2.  "Call"

### Storing an address

1. Select the message.
2. Open "Options".
3. "Store contact in vehicle"

### Deleting messages

1. Select the message to be deleted.
2. Open "Options".
3. "Delete message" or "Delete all messages"

## Hands-free system

### General information

Calls that are being made on the hands-free system can be continued on the mobile phone and vice versa.

### From the mobile phone to the hands-free system

Calls that were begun outside of the Bluetooth range of the vehicle can be continued on the hands-free system with the ignition switched on.

Depending on the mobile phone, the system automatically switches to the hands-free system.

If the system does not switch over automatically, follow the instructions on the mobile phone display;

refer also to the mobile phone operating instructions.

### From the hands-free system to the mobile phone

Calls that are made on the hands-free system can in some cases be continued on the mobile phone; this depends on the mobile phone.

Follow the instructions on the mobile phone display; refer also to the mobile phone operating instructions.

## Snap-in adapter\*

### Installation position

In the center armrest.

### Inserting the snap-in adapter



Press the button and remove the cover.



Insert the snap-in adapter at the front, arrow 1, and press down, arrow 2, until it engages.

## Inserting the mobile phone



1. Depending on the mobile phone, remove the protective cap from the antenna connector of the mobile phone.
2. With the buttons facing up, slide the mobile phone up toward the electrical contacts and press it down until it engages.

## Removing the mobile phone



Press the button and remove the mobile phone.

# Contacts

## General information

Contacts can be created and edited. The contacts from the mobile phone are displayed as well if this function is supported by the mobile phone. The addresses can be adopted as destinations for navigation and the phone numbers can be dialed directly.

## New contact

1. "Contacts"
2. "New contact"



3. If the entry fields are still filled with previous entries, select "Delete input fields".
4. Fill in the entry fields: select the symbol next to the entry field.



5. Enter the text, refer to page 24.
6. When equipped with a navigation system: Enter the address. Only addresses contained in the navigation data in the vehicle can be entered. This ensures that destination guidance is possible for all addresses.

7. If necessary, "Store".
8. "Store contact in vehicle"

## Specifying a contact as the home address

A contact can be stored as a home address. It is placed at the top of "My contacts".

1. Create a new contact.
2. Open "Options".
3. "Store as home address"

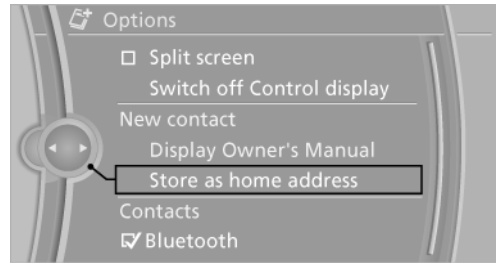

## My contacts

### General information

A list of all contacts in the vehicle and mobile phone.

### Displaying contacts

1. "My contacts"



All contacts are listed in alphabetical order. An **A-Z search** is offered, refer to page 24, if there are 30 or more contacts.

A symbol indicates the storage location of the contacts:

Symbol	Storage location
No symbol	In the vehicle; the address has not been checked as a destination.
📍	In the vehicle; the address has been checked as a destination.
📱	Mobile phone

## Displaying the detailed view

Select the desired contact.

All fields that have been filled in for that contact are displayed.

## Selecting the contact as a navigation destination\*

1. "My contacts"
2. Select the desired contact.
3. Select the desired address.

When contacts from the mobile phone are used, the address may need to be matched to the navigation data contained in the vehicle. In this case: Correct the address.

## Checking the address as a destination\*

An address that is to be used for destination guidance must match the navigation data contained in the vehicle. The address can be checked for this purpose.

1. Select the desired contact and highlight the address.
2. Open "Options".
3. "Check as destination"
4. Correct and store the address if necessary.

If the address is corrected and stored, a copy of it is stored in the vehicle. The address is not changed on the mobile phone.

## Dialing phone numbers\*

1. "My contacts"

2. Select the desired contact.
3. Select the desired phone number.

The connection is established.

## Editing a contact

1. "My contacts"
2. Select the desired contact.
3. "Edit contact"



4. Change the entries.
5. Move the controller to the left.
6. "Yes"

If a contact from the mobile phone is edited, the changes are not stored on the mobile phone. A copy of the entry is stored in the vehicle, and only this copy is displayed.

## Deleting contacts

Only contacts that are stored in the vehicle are deleted. The contacts on the mobile phone cannot be deleted.

1. "My contacts"
2. Highlight the contact.
3. Open "Options".
4. "Delete contact" or "Delete all contacts".

## Exporting/importing contacts

Contacts can be exported and imported via the [Personal Profile](#), refer to page 33.

# BMW Assist

## BMW Assist\*

### General information

BMW Assist provides you with various services, e.g., transmission of the position data of your vehicle to the BMW Assist Response Center if an Emergency Request\* has been initiated.

Many BMW Assist services depend on the individually agreed upon contract.

After your contract has expired, the BMW Assist system will be deactivated by the BMW Assist Response Center without your having to visit a service center. After the BMW Assist system has been deactivated, no BMW Assist services will be available. The BMW Assist system can be reactivated by a service center after you sign a new contract.

### Requirements

- ▷ The installed BMW Assist system is logged in to a wireless communications network. This network must be capable of transmitting the services.
- ▷ To transmit position data, the vehicle must be able to determine the current position.
- ▷ To activate and update BMW Assist, a GPS signal must be available.
- ▷ The BMW Assist service contract was signed with your service center or with the BMW Assist Response Center. Enabling must have been completed.
- ▷ BMW Assist is activated.

### Services offered

- ▷ **Emergency Request:** when you press the SOS button, a connection to the BMW Assist Response Center is established. The BMW Assist Response Center then speaks with you and takes further steps to help you.
- ▷ **Automatic Collision Notification:** under certain conditions, a connection is established to the BMW Assist Response Center after a

serious accident. If possible, the BMW Assist Response Center then speaks with you and takes further steps to help you.

- ▷ **Enhanced Roadside Assistance: BMW Roadside Assistance\*** can be contacted if assistance is needed in the event of a breakdown. If possible, the vehicle and position data are transmitted in the process.
  - ▷ **Customer Relations:** connection with Customer Relations for information on all aspects of your vehicle.
  - ▷ **TeleService:** data on your vehicle's service status or required inspections are transmitted either automatically before a service due date, or when you request a BMW service appointment.
  - ▷ **Remote Door Unlock:** the BMW Assist Response Center provides assistance if, for example, the remote control is not available and the vehicle needs to be opened.
  - ▷ **Stolen Vehicle Recovery:** after you report that your vehicle was stolen to the police, the BMW Assist Response Center can determine its position.
  - ▷ In addition to these services, the optional Convenience Plan offers a Concierge service and information for route planning, traffic, and weather. A limited number of calls can be made via the BMW Assist Response Center with Critical Calling if, for example, the mobile phone is not available or discharged.
- Press the SOS button to contact the BMW Assist Response Center.
- ▷ You can also access the BMW Assist Concierge service via the Internet.



# TeleService\*

## General information

TeleService supports communication with your service center.

- ▷ Data on the vehicle's service requirements can be sent directly to the service center. In this way, the service center can plan its work in advance. This shortens the duration of the service appointment.
- ▷ In the event of a breakdown, data on the vehicle's condition can be sent directly to Roadside Assistance.
- ▷ The offer varies by country.
- ▷ Connection costs may ensue.
- ▷ Services may be restricted abroad.

## Requirements

- ▷ BMW Assist is activated.
- ▷ Wireless reception is available.
- ▷ The engine is running.

# Concierge service\*

## General information

The BMW Assist Concierge service offers information on events, gas stations or hotels, and provides phone numbers and addresses. Hotels can be booked directly by the BMW Assist Concierge service. The Concierge service is part of the optional Convenience Plan.

## Starting the Concierge service

1. "BMW Assist"

2. "Concierge"



3. "Start service"

A voice connection is established with the BMW Assist Concierge service. Phone numbers and addresses can be transmitted to the vehicle.

Open the message via the [message list](#), refer to [page 211](#).

# Roadside Assistance

## At a glance

BMW Roadside Assistance\* can be contacted if assistance is needed in the event of a breakdown.

## Starting Roadside Assistance

## Vehicle not equipped with BMW Assist or TeleService

1. "BMW Assist"
2. "TeleService Diagnosis"

The Roadside Assistance number is displayed. If the mobile phone\* is paired, a connection is established to Roadside Assistance.

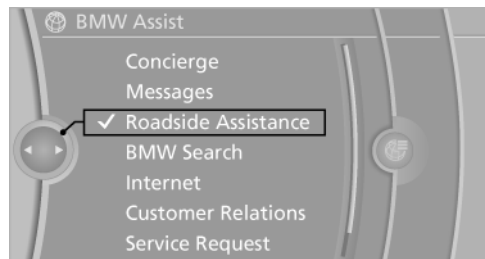

## Vehicle equipped with BMW Assist or TeleService

1. "BMW Assist"
2. "Roadside Assistance"
3. "Start service"

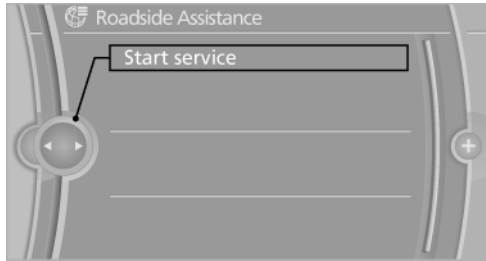

### TeleService Diagnosis\*

TeleService Diagnosis enables the wireless transmission of detailed vehicle data that are important for vehicle diagnosis. These data are transmitted automatically.

After the data are transmitted, the voice connection to Roadside Assistance is re-established.

### TeleService Help\*

TeleService Help enables an in-depth diagnosis of the vehicle by Roadside Assistance via wireless transmission.

TeleService Help can be started after a prompt by Roadside Assistance and the termination of the voice connection.

### Starting TeleService Help

1. Park the vehicle in a safe place.
2. Set the parking brake.
3. The engine is running.
4. "TeleService Help"

After completion of TeleService Help, a voice connection is established to Roadside Assistance.

## Activating BMW Assist\*

### General information

If the services included in a Assist subscription are not displayed, they may need to be activated.

### Activating

1. Make sure that the vehicle can determine its current position. Reception is usually best when you have an unobstructed view of the sky.
2. Switch on the ignition.
3. "Activate BMW Assist"

Activation may take several minutes. If another menu is opened, activation continues running in the background.

## BMW Search\*

### At a glance

A business search can be opened via BMW Search.

License conditions

This product contains NetFront Browser of ACCESS CO., LTD. Copyright (c) 2007 ACCESS CO., LTD. All rights reserved.

NetFront is a trademark or registered trademark of ACCESS CO., LTD., in Japan and other countries.

This software is based in part on the work of the Independent JPEG Group.

### Requirements

- ▷ Subscription to the optional Convenience Plan.
- ▷ The [date setting](#), refer to [page 81](#), on the Control Display is current.
- ▷ The vehicle is located within wireless network coverage.

### Starting BMW Search

1. "BMW Assist"

## 2. "BMW Search"

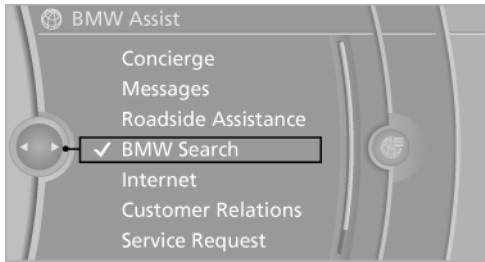

## 3. If necessary, "OK".

The BMW Search home page is displayed.

## Using BMW Search

To start a search:

- ▶ Turn the controller to highlight an element.
- ▶ Press the controller to display an element.

## Opening the start page

1. Open "Options".
2. "Home"

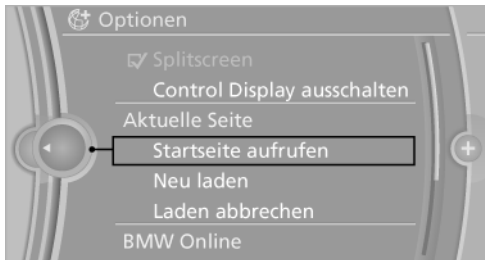

## Loading a new page

1. Open "Options".
2. "Reload"

## Cancel

1. Open "Options".
2. "Cancel loading"

# TeleService\*

## Activating TeleService

TeleService must be activated in the vehicle. Usually this will already have been performed by your service partner.

"Activate TeleService"

## Customer Relations

### At a glance

Contact Customer Relations for information on all aspects of your vehicle.

### Calling Customer Relations

#### Vehicle not equipped with BMW Assist or TeleService

1. "BMW Assist"
2. "Customer Relations"

The Customer Relations telephone number is displayed. If the mobile phone\* is paired, a connection is established to Customer Relations.

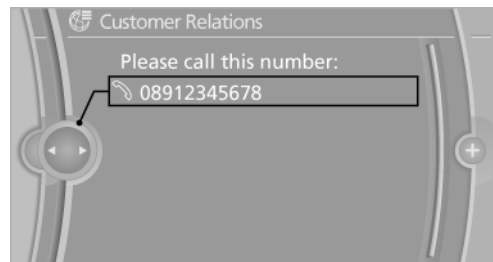

#### Vehicle equipped with BMW Assist or TeleService

1. "BMW Assist"
2. "Customer Relations"
3. "Start service"

## Service Request\*

### At a glance

Sends information to your authorized dealership to request the arrangement of a service appointment. The TeleService data is transmitted during a Service Request. If possible, your authorized dealership will establish contact with you.

### Starting a Service Request

1. "BMW Assist"
2. "Service Request"
3. "Start service"



## Automatic Service Request\*

The TeleService data necessary for servicing the vehicle are automatically sent to your authorized dealership prior to the service deadline. If possible, the authorized dealership will contact you and a service appointment can be arranged.

To check when your authorized dealership was notified:

1. "Vehicle Info"
2. "Vehicle status"

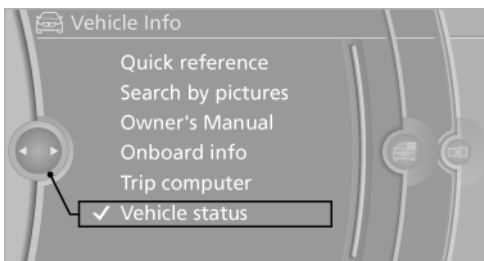

3. Open "Options".
4. "Last Service Request"

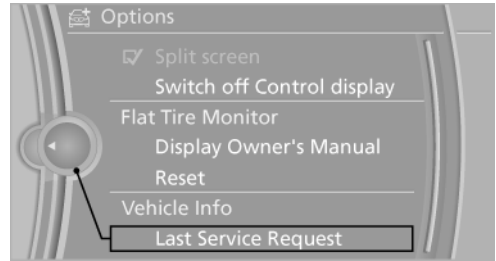

## Authorized dealership\*

Address and contact data of the authorized dealership.

### Displaying authorized dealerships

1. "BMW Assist"
2. "Your BMW center"

## Data transfer\*

The status of the data transfer is displayed.

1. "BMW Assist"
2. "Data transfer"

## Services status\*

### Displaying available services

Display of all services available in the vehicle. This function can be called up via "Options".

1. "BMW Assist"
2. Open any menu.
3. Open "Options".
4. "Service status"

## 5. "Available services"

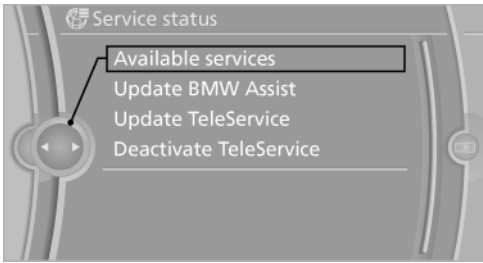

### Activating BMW Assist

If the services included in a Assist subscription are not displayed, they may need to be activated.

"Activate BMW Assist"

### Activating TeleService

TeleService may need to be activated in the vehicle.

"Activate TeleService"

### Deactivating TeleService

Even if the services of TeleService have been deactivated, a voice connection to Roadside Assistance is still possible.

"Deactivate TeleService"



## Mobility

To ensure that you remain mobile at all times, this chapter supplies you with important information on the topics of fuels and lubricants, wheels and tires, service, maintenance, and Roadside Assistance.

# Refueling

## Fuel cap

### Opening

1. Briefly press the rear edge of the fuel filler door.



2. Turn the fuel filler cap counterclockwise.

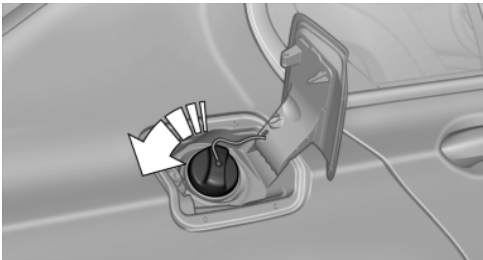

3. Place the fuel filler cap in the bracket attached to the fuel filler door.

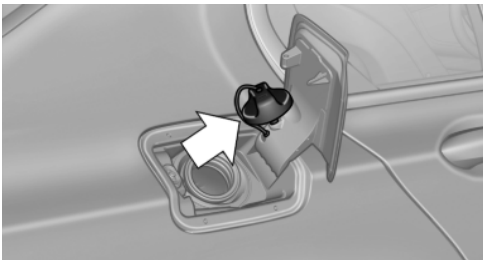

### Closing

Fit the cap and turn it clockwise until you clearly hear a click.

 Do not pinch the retaining strap

Do not pinch the retaining strap attached to the cap; otherwise, the cap cannot be closed properly and fuel vapors can escape.

A message is displayed if the cap is loose or missing. ◀

### Manually unlocking fuel filler door

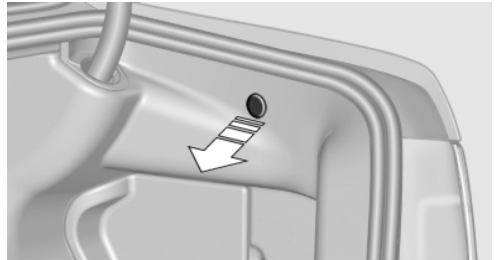

In the event of an electrical malfunction, for example.



Pull the green knob with the fuel pump symbol. This releases the fuel filler door.



### Observe the following when refueling

The fuel tank is full when the filler nozzle clicks off the first time.

-  Handling fuels
-  Obey safety regulations posted at the gas station. ◀

### Fuel tank capacity

Gasoline engine Fuel tank capacity: approx. 21.6 US gal/82 liters

-  Refuel promptly
-  Refuel below a range of 30 miles/50 km; otherwise, engine functions are not ensured and damage may occur. ◀



# Fuel

## Fuel quality

 Refuel with unleaded fuel only  
Do not use leaded fuel as this would permanently damage the catalytic converter. ◀

 Do not refuel with ethanol  
Do not refuel with E85, i.e., fuel with an ethanol content of 85 %, or with Flex Fuel, as this would damage the engine and fuel supply system. ◀

## Required fuel

### Super Premium Gasoline/AKI 91

This gasoline is highly recommended.

### Gasoline with lower AKI

However, you may also use gasoline with less AKI.

The minimum AKI Rating is 89.

If you use gasoline with this minimum AKI Rating, the engine may produce knocking sounds when starting at high outside temperatures.

This has no effect on the engine life.

 Minimum fuel grade  
Do not use any gasoline below the minimum specified fuel grade; otherwise, engine damage may occur. ◀

## Use high-quality brands

Field experience has indicated significant differences in fuel quality: volatility, composition, additives, etc., among gasolines offered for sale in the United States and Canada.

Fuels containing up to and including 10 % ethanol or other oxygenates with up to 2.8 % oxygen by weight, that is, 15 % MTBE or 3 % methanol plus an equivalent amount of co-solvent, will not void the applicable warranties with respect to defects in materials or workmanship.

 Minimum fuel grade

The use of poor-quality fuels may result in driveability, starting and stalling problems especially under certain environmental conditions such as high ambient temperature and high altitude.

Should you encounter driveability problems which you suspect could be related to the fuel you are using, we recommend that you respond by switching to a recognized high-quality brand such as gasoline that is advertised as Top Tier Detergent Gasoline.

Failure to comply with these recommendations may result in unscheduled maintenance. ◀

# Wheels and tires

## Tire inflation pressure

### Safety information

The tire characteristics and tire inflation pressure influence the following:

- ▷ The service life of the tires.
- ▷ Road safety.
- ▷ Driving comfort.

### Checking the pressure

Only check the tire inflation pressure when the tires are cold. This means after driving no more than 1.25 miles/2 km or when the vehicle has been parked for at least 2 hours. When the tires are warm, the tire inflation pressure is higher.

 Check the tire inflation pressure regularly  
 Regularly check the tire inflation pressure and correct it as needed: at least twice a month and before a long trip. If you fail to observe this precaution, you may be driving on tires with incorrect tire pressures, a condition that may not only compromise your vehicle's driving stability, but also lead to tire damage and the risk of an accident. ◀

After correcting the tire inflation pressure, reinitialize the Flat Tire Monitor.

After correcting the tire inflation pressure, reinitialize the Tire Pressure Monitor.

### Pressure specifications

The [tire inflation pressure table](#), refer to [page 226](#), contains all pressure specifications for the specified tire sizes at the ambient temperature. Pressure specifications apply to approved tire sizes and recommended tire brands. This information can be obtained from your service center.

To identify the correct tire inflation pressure, please note the following:

- ▷ Tire sizes of your vehicle.
- ▷ Vehicle load.

- ▷ Maximum allowable driving speed.

### Tire inflation pressures up to 100 mph/160 km/h

For speeds of up to 100 mph/160 km/h and for optimum driving comfort, note the pressure values in the [tire inflation pressure table](#), refer to [page 226](#), and adjust as necessary.

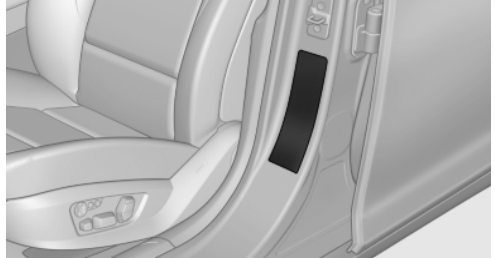

These pressure values can also be found on the tire inflation pressure label on the driver's door post.

 Maximum permissible speed  
 Do not exceed 100 mph/160 km/h; otherwise, tire damage and accidents may result. ◀

### Tire inflation pressure values up to 100 mph/160 km/h

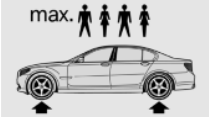
Tire size	Pressure specifications in psi/kPa	
Specifications in psi/kilopascal with cold tires		
F.: 245/45 R 19 98 Y	2,2 / 32	-
R.: 275/40 R 19 101 Y	-	2,2 / 32
F.: 245/40 R 20 99 Y	2,4 / 35	2,4 / 35
XL		
R.:		
275/35 R 20 102 Y XL		

Tire size	Pressure specifications in psi/kPa	
F.: 245/35 R 21 96 Y XL	2,6 / 38	-
R.: 275/30 R 21 98 Y XL	-	2,6 / 38
245/50 R 18 100 Y	2,2 / 32	2,4 / 35
245/50 R 18 100 V M +S A/S		
245/50 R 18 100 H M +S		
245/45 R 19 102 V M +S XL	2,4 / 35	2,6 / 38

### Tire inflation pressures at max. speeds above 100 mph/160 km/h



Speeds above 100 mph/160 km/h

In order to drive at maximum speeds in excess of 100 mph/160 km/h, please observe, and, if necessary, adjust tire pressures for speeds exceeding 100 mph/160 km/h from the relevant table on the following pages. Otherwise tire damage and accidents could occur. ◀

### Tire inflation pressure values over 100 mph/160 km/h

Tire size	Pressure specifications in psi/kPa	
Specifications in psi/kilopascal with cold tires		
F.: 245/45 R 19 98 Y	2,2 / 32	-
R.: 275/40 R 19 101 Y	-	2,2 / 32
F.: 245/40 R 20 99 Y XL	2,4 / 35	-
XL	-	2,4 / 35
R.: 275/35 R 20 102 Y XL		

Tire size	Pressure specifications in psi/kPa	
F.: 245/35 R 21 96 Y XL	2,6 / 38	-
R.: 275/30 R 21 98 Y XL	-	2,6 / 38
245/50 R 18 100 V M +S A/S	2,2 / 32	2,4 / 35
245/50 R 18 100 H M +S		
245/45 R 19 102 V M +S XL	2,4 / 35	2,6 / 38

### Tire size

Specifications in psi/kilopascal with cold tires



F.: 245/45 R 19 98 Y	2,5 / 36	-
R.: 275/40 R 19 101 Y	-	2,5 / 36
F.: 245/40 R 20 99 Y XL	2,7 / 39	-
R.: 275/35 R 20 102 Y XL	-	2,7 / 39
F.: 245/35 R 21 96 Y XL	2,9 / 42	-
R.: 275/30 R 21 98 Y XL	-	3,0 / 44
245/50 R 18 100 V M+S A/S	2,5 / 36	2,8 / 41
245/50 R 18 100 H M+S		
245/45 R 19 102 V M +S XL	2,7 / 39	3,0 / 44

## Tire identification marks

### Tire size

245/45 R 18 96 W  
 245: nominal width in mm  
 45: aspect ratio in %  
 R: radial tire code

18: rim diameter in inches  
96: load rating, not for ZR tires  
W: speed rating, before the R on ZR tires

## Speed letter

T = up to 118 mph/190 km/h  
H = up to 131 mph/210 km/h  
V = up to 150 mph/240 km/h  
W = up to 167 mph/270 km/h  
Y = up to 186 mph/300 km/h

## Tire Identification Number

DOT code: DOT xxxx xxx 3508  
xxxx: manufacturer code for the tire brand  
xxx: tire size and tire design  
3508: tire age  
Tires with DOT codes meet the guidelines of the U.S. Department of Transportation.

## Tire age

DOT ... 3508: the tire was manufactured in the 35th week in 2008.  
Recommendation: regardless of wear, replace tires at least every 6 years.

## Uniform Tire Quality Grading

Quality grades can be found where applicable on the tire sidewall between tread shoulder and maximum section width.  
For example: Treadwear 200; Traction AA; Temperature A

## DOT Quality Grades

Treadwear  
Traction AA A B C  
Temperature A B C

All passenger car tires must conform to Federal Safety Requirements in addition to these grades.

## Treadwear

The treadwear grade is a comparative rating based on the wear rate of the tire when tested

under controlled conditions on a specified government test course. For example, a tire graded 150 would wear one and one-half, 1 g, times as well on the government course as a tire graded 100. The relative performance of tires depends upon the actual conditions of their use, however, and may depart significantly from the norm due to variations in driving habits, service practices and differences in road characteristics and climate.

## Traction

The traction grades, from highest to lowest, are AA, A, B, and C.  
Those grades represent the tire's ability to stop on wet pavement as measured under controlled conditions on specified government test surfaces of asphalt and concrete. A tire marked C may have poor traction performance.

The traction grade assigned to this tire is based on straight-ahead braking traction tests, and does not include acceleration, cornering, hydroplaning, or peak traction characteristics.

## Temperature

The temperature grades are A, the highest, B, and C, representing the tire's resistance to the generation of heat and its ability to dissipate heat when tested under controlled conditions on a specified indoor laboratory test wheel. Sustained high temperature can cause the material of the tire to degenerate and reduce tire life, and excessive temperature can lead to sudden tire failure. The grade C corresponds to a level of performance which all passenger car tires must meet under the Federal Motor Vehicle Safety Standard No. 109. Grades Band A represent higher levels of performance on the laboratory test wheel than the minimum required by law.



Temperature grade for this tire

The temperature grade for this tire is established for a tire that is properly inflated and not overloaded. Excessive speed, underinflation, or excessive loading, either separately or in combination, can cause heat buildup and possible tire failure.

If necessary, have the vehicle towed. ◀

## RSC – Run-flat tires

Run-flat tires, refer to page 231, are labeled with a circular symbol containing the letters RSC marked on the sidewall.

## M+S

Winter and all-season tires with better cold weather performance than summer tires.

## Tire tread

### Summer tires

Do not drive with a tire tread depth of less than 0.12 in/3 mm.

There is an increased danger of hydroplaning if the tread depth is less than 0.12 in/3 mm.

### Winter tires

Do not drive with a tire tread depth of less than 0.16 in/4 mm.

Below a tread depth of 0.16 in/4 mm, tires are less suitable for winter operation.

### Minimum tread depth



Wear indicators are distributed around the tire's circumference and have the legally required minimum height of 0.063 in/1.6 mm.

They are marked on the side of the tire with TWI, Tread Wear Indicator.

## Tire damage

Inspect your tires often for damage, foreign objects lodged in the tread, and tread wear.

Indications of tire damage or other vehicle defects:

- ▷ Unusual vibrations during driving.
- ▷ Unusual handling such as a strong tendency to pull to the left or right.



In case of tire damage

If there are indications of tire damage, reduce your speed immediately and have the wheels and tires checked right away; otherwise, there is the increased risk of an accident.

Drive carefully to the next authorized dealership or tire shop.

If necessary, have the vehicle towed. ◀



Repair of tire damage

For safety reasons, the manufacturer of your vehicle recommends that you do not have damaged tires repaired; they should be replaced. Otherwise, damage can occur as a result. ◀

## Tire age

### Recommendation

regardless of wear, replace tires at least every 6 years.

### Manufacture date

On the sidewall:

DOT ... 3508: the tire was manufactured in the 35th week in 2008.

## Changing wheels and tires

### Mounting



Information on mounting tires

Have mounting and balancing performed only by an authorized dealership.

If this work is not carried out properly, there is the danger of subsequent damage and related safety hazards. ◀

## Wheel and tire combination

Information on the correct wheel-tire combination and rim versions for your vehicle can be obtained from your service center.

Incorrect wheel and tire combinations impair the function of a variety of systems such as ABS or DSC.

To maintain good handling and vehicle response, use only tires with a single tread configuration from a single manufacturer.

Following tire damage, have the original wheel and tire combination remounted on the vehicle as soon as possible.

### Approved wheels and tires

The manufacturer of your vehicle recommends that you use only wheels and tires that have been approved for your particular vehicle model.

For example, despite having the same official size ratings, variations can lead to body contact and with it, the risk of severe accidents.

The manufacturer of your vehicle cannot evaluate non-approved wheels and tires to determine if they are suited for use, and therefore cannot ensure the operating safety of the vehicle if they are mounted. ◀

## Recommended tire brands



For each tire size, the manufacturer of your vehicle recommends certain tire brands. These can be identified by a star on the tire sidewall.

With proper use, these tires meet the highest standards for safety and handling.

## Retreaded tires

The manufacturer of your vehicle does not recommend the use of retreaded tires.

### Retreaded tires

Possibly substantial variations in the design and age of the tire casing structures can limit service life and have a negative impact on road safety. ◀

## Winter tires

The manufacturer of your vehicle recommends winter tires for winter roads or at temperatures below +45 °F/+7 °C.

Although so-called all-season M+S tires do provide better winter traction than summer tires, they do not provide the same level of performance as winter tires.

## Maximum speed of winter tires

If the maximum speed of the vehicle is higher than the permissible speed for the winter tires, then display a corresponding sign in the field of vision. You can obtain this sign from the tire specialist or from your service center.

### Maximum speed for winter tires

Do not exceed the maximum speed for the winter tires; otherwise, tire damage and accidents can occur. ◀

## Run-flat tires

For your own safety, only use run-flat tires. No spare tire is available in the case of a flat tire. Your service center will be glad to advise you.

## Rotating wheels between axles

The manufacturer of your vehicle advises against swapping wheels between the front and rear axles.

This can impair the handling characteristics.

## Storage

Store wheels and tires in a cool, dry place with as little exposure to light as possible.

Always protect tires against all contact with oil, grease and fuels.

Do not exceed the maximum tire inflation pressure indicated on the side wall of the tire.

## Run-flat tires

### Label



RSC label on the tire sidewall

The wheels are composed of special rims and tires that are self-supporting, to a limited degree.

The support of the sidewall allows the tire to remain drivable to a restricted degree in the event of a pressure loss.

[Continued driving with damaged tires, refer to page 96](#)[Continued driving with damaged tires, refer to page 94.](#)

### Changing run-flat tires

For your own safety, only use run-flat tires. No spare tire is available in the case of a flat tire. Your authorized dealership will be glad to advise you.

## Snow chains

### Fine-link snow chains

Only certain types of fine-link snow chains have been tested by the manufacturer of your vehicle, classified as road-safe and recommended.

Consult your service center for more information.

### Use

Use only in pairs on the rear wheels, equipped with the same tire size:

- ▷ 245/55 R 17.
- ▷ 245/50 R 18.
- ▷ 245/45 R 19.

Follow the chain manufacturer's instructions.

Make sure that the snow chains are always sufficiently tight. Retighten as needed according to the chain manufacturer's instructions.

Do not initialize the Flat Tire Monitor after mounting snow chains, as doing so may result in incorrect readings.

Do not initialize the Tire Pressure Monitor after mounting snow chains, as doing so may result in incorrect readings.

When driving with snow chains, briefly activate Dynamic Traction Control if necessary.

### Maximum speed with snow chains

Do not exceed a speed of 30 mph/50 km/h when using snow chains.

### Snow chain detection\*

#### The concept

When using snow chains, you should set whether you are driving with or without snow chains via the iDrive.

The snow chain detection system supports you by automatically showing the detected state on the Control Display.

When snow chains are in use, the rear axle steering of the Integral Active Steering\* is deactivated automatically.

At speeds above the maximum allowable speed with snow chains of 30 mph/50 km/h, the rear axle steering is activated again automatically.

#### Activating the status

1. "Settings"

2. "Tire chains"
3. "Tire chains installed"

## Automatic detection

If functioning properly:

- ▶ Snow chains are mounted. The setting is not activated  .

After you drive a short distance, the message is shown on the Control Display and the status is activated automatically.

Confirm the automatic activation.

- ▶ Snow chains are not mounted. The setting is activated  .

At speeds above 30 mph/50 km/h, a warning lamp lights up and a message is displayed.

Deactivate the status manually.

If not functioning properly:

- ▶ Snow chains are mounted. The setting is not activated  .

A message does not appear on the Control Display.

The automatic detection system is malfunctioning. Activate the status manually.

## Activating/deactivating rear axle steering

If the status indicating that snow chains are in use is activated, the rear axle steering is deactivated automatically.

At speeds above 30 mph/50 km/h, the rear axle steering is activated again, even though snow chains are in use.



# Engine compartment

## Important features in the engine compartment

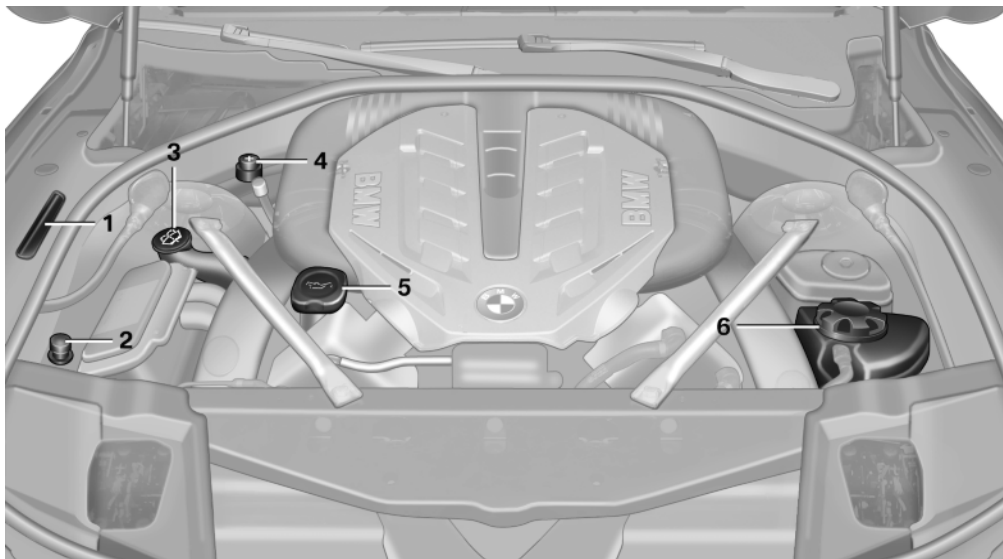

- |   |                                  |   |                                  |
|---|----------------------------------|---|----------------------------------|
| 1 | Vehicle identification number*   | 4 | Jump starting, positive terminal |
| 2 | Jump starting, negative terminal | 5 | Oil filler neck                  |
| 3 | Container for washer fluid       | 6 | Coolant reservoir                |

## Hood

### Opening the hood



Working in the engine compartment

Never attempt to perform any service or repair operations on your vehicle without the necessary professional technical training.

If you are unfamiliar with the statutory guidelines, have any work on the vehicle performed only by an authorized dealership.

If this work is not carried out properly, there is the danger of subsequent damage and related safety hazards. ◀

1. Pull the lever.

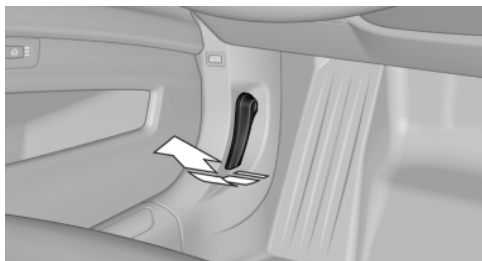

2. Press the release handle and open the hood.

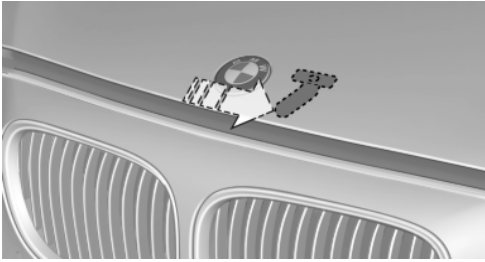

3. Be careful of protruding parts on the hood.



Danger of injury when the hood is open

There is a danger of injury from protruding parts when the hood is open. ◀

### Closing the hood

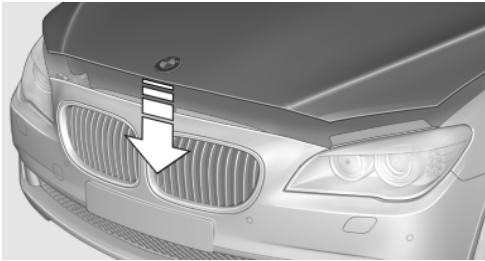

Let the hood drop from a height of approx. 16 in/ 40 cm and push down on it to lock it fully.

The hood must audibly engage on both sides.



Hood open when driving

If you see any signs that the hood is not completely closed while driving, pull over immediately and close it securely. ◀



Danger of pinching

Make sure that the closing path of the hood is clear; otherwise, injuries may result. ◀

# Engine oil

## Checking the oil level

### The concept

The oil level is monitored electronically and displayed on the Control Display.

### Requirements

- ▷ The engine must be running and warm after the vehicle has been driven for at least 6 miles/10 km.
- ▷ The vehicle is stopped or being driven on a level roadway.

### Displaying the oil level

1. "Vehicle Info"
2. "Vehicle status"
3. "Engine oil level"

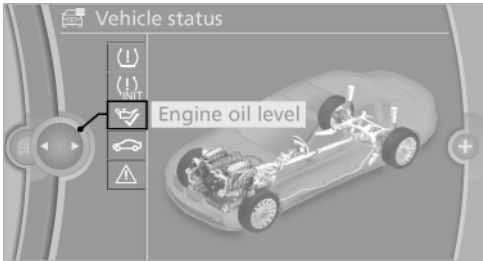

### Possible messages

- ▷ "Engine oil level OK"
- ▷ "Measurement not possible at this time."  
Duration with the engine running: approx. 3 minutes.  
Duration while driving: approx. 5 minutes.
- ▷ "Engine oil level below minimum. Add 1 quart!"  
Add oil within the next 125 miles/200 km.
- ▷ "Engine oil level too high! Have this checked."  
Have the vehicle checked immediately.



Too much engine oil

- Have the vehicle checked immediately; otherwise, surplus oil can lead to engine damage. ◀
- ▷ "Measurement inactive. Have this checked."

Note the newly calculated remaining mileage until the next oil service. Have the system checked as soon as possible.

## Adding engine oil

### Filler neck

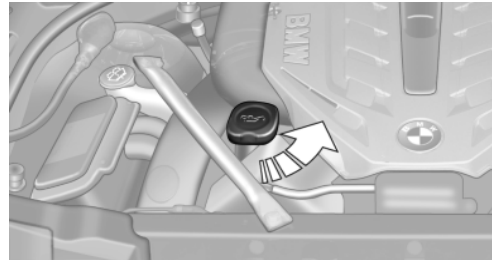

When the indicator lights up in the instrument cluster, add 1 US quart/liter of engine oil within the next 125 miles/200 km.

Recommended oil types, refer to page 235



Protect children

Keep oil, grease, etc., out of reach of children and heed the warnings on the containers to prevent health risks. ◀

## Oil types

### Approved oil types

Your service center can advise you on which engine oils have been approved by BMW.

The engine oil quality is critical for the life of the engine.

Only use approved BMW High Performance oil.



No oil additives

Oil additives may lead to engine damage. ◀

## Alternative oil types

If the approved engine oils are not available, up to 1 US quart/liter of the following oils may be used:

Use API SM quality standards or higher.

## Viscosity grades

Viscosity is a measure of the oil's resistance to flow and is classified in SAE grades.

The selection of a suitable SAE grade depends on the climatic conditions in the region where you normally drive your BMW.

Approved oils belong to the SAE grades 0W-40, 0W-30, 5W-40 and 5W-30. These oils can be used for driving at all external temperatures.

BMW recommends 

## Coolant

### General information



Danger of burns from hot engine

Do not open the cooling system while the engine is hot; otherwise, escaping coolant may cause burns. ◀



Suitable additives

Only use suitable additives; otherwise, engine damage may occur. The additives are harmful to your health. ◀

Coolant consists of water and additives.

Not all commercially available additives are suitable for your vehicle. Ask your service center for suitable additives.

### Coolant level

#### Checking

1. Let the engine cool.

2. Turn the cap of the expansion tank slightly counterclockwise to allow any excess pressure to dissipate, and then open it.

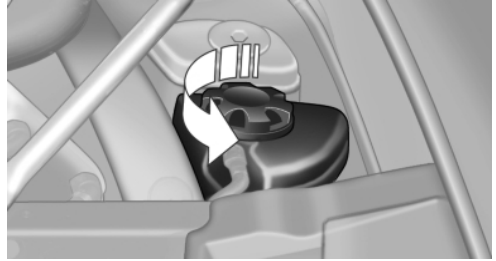

3. The coolant level is correct if it lies between the minimum and maximum marks in the filler neck.



4. If the coolant is low, slowly add coolant up to the specified level; do not overfill.
5. Turn the cap until there is an audible click.
6. Have the cause of the coolant loss eliminated as soon as possible.

### Disposal



Comply with the relevant environmental protection regulations when disposing of coolant and coolant additives.

# Maintenance

## BMW Maintenance System

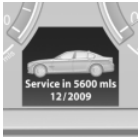

The system obtains information about the road safety and operational reliability of the vehicle and takes into account aspects such as a timely vehicle check. The aim is to optimize maintenance procedures with a view to reducing the cost of running the vehicle.

## Condition Based Service CBS

Sensors and special algorithms take into account the driving conditions of your vehicle. Based on this, Condition Based Service determines the maintenance requirements.

The system makes it possible to adapt the amount of maintenance you need to your user profile.

Details on the [service requirements](#), refer to [page 82](#), can be displayed on the Control Display.

## Service data in the remote control

Information on the required maintenance is continuously stored in the remote control. Your service center will read out this data and suggest the right array of service procedures for your vehicle.

Therefore, hand your service specialist the remote control that you used most recently.

## Storage periods

Storage periods during which the vehicle battery was disconnected are not taken into account.

If this occurs, have a service center update the time-dependent maintenance procedures, such as checking brake fluid and, if necessary, changing the engine oil and the microfilter/activated-charcoal filter.

## Service and Warranty Information Booklet for US models and Warranty and Service Guide Booklet for Canadian models

Please consult your Service and Warranty Information Booklet for US models and Warranty and Service Guide Booklet for Canadian models for additional information on service requirements.

Maintenance and repair should be performed by your service center. Make sure to have regular maintenance procedures recorded in the vehicle's Service and Warranty Information Booklet for US models, and in the Warranty and Service Guide Booklet for Canadian models. These entries are proof of regular maintenance.

## Socket for OBD Onboard Diagnostics

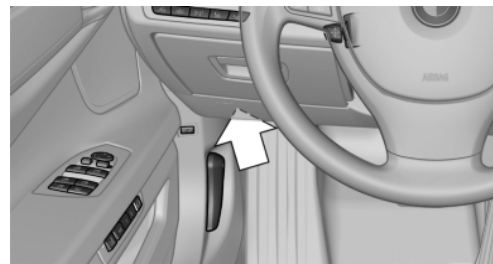

On the driver's side is an OBD socket for testing components that are critical to exhaust composition.

## Emissions values



- ▷ The warning lamp lights up:

The emissions values are deteriorating. Have the vehicle checked as soon as possible.



- ▷ The warning lamp flashes under certain circumstances:

This indicates that there is excessive misfiring in the engine.

Reduce the vehicle speed and have the system checked immediately; otherwise, serious engine misfiring within a brief period can seriously damage emission control components, in particular the catalytic converter.

## Fuel cap



The indicator lamp lights up.

If the fuel cap is not properly tightened, the OBD system may conclude that fuel vapor is escaping. If the cap is then tightened, the display should go out in a short time.

## Data recorders

The vehicle may be equipped with measuring and diagnostic modules or with a device for recording and transmitting certain vehicle data. If you are using Assist, certain vehicle data can be transmitted or recorded in order to enable the corresponding services.

# Replacing components

## Tool kit



The tool kit is located in a fold-down cover in the trunk lid.

Unscrew the wing nut to open.

## Wiper blade replacement

### Replacing the wiper blades

1. To change the wiper blades, **fold up**, refer to [page 71](#), the wiper arms.
2. Fold up the wipers.

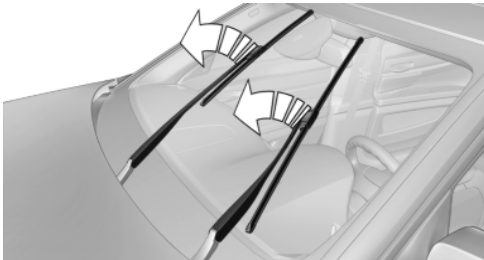

3. Position the wiper blade in a horizontal position.

4. Remove the wiper blade toward one side.

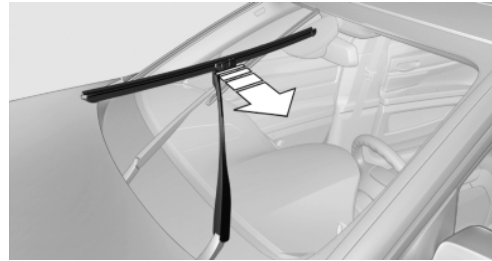

**!** Do not fold down the wipers without wiper blades

Do not fold down the wipers if wiper blades have not been installed; this may damage the windshield. ◀

## Lamp and bulb replacement

### General information

Lamps and bulbs make an essential contribution to vehicle safety.

The manufacturer of your vehicle recommends that you entrust corresponding procedures to your service center if you are unfamiliar with them or they are not described here.

You can obtain a selection of replacement bulbs at your service center.

**!** Danger of burns  
Only change bulbs when they are cool; otherwise, there is the danger of getting burned. ◀

**!** Working on the lighting system  
When working on the lighting system, you should always switch off the lights affected to prevent short circuits.

To avoid possible injury or equipment damage when replacing bulbs, observe any instructions provided by the bulb manufacturer. ◀

**!** Do not touch the bulbs

Do not touch the glass of new bulbs with your bare hands, as even minute amounts of contamination will burn into the bulb's surface and reduce its service life.

Use a clean tissue, cloth or something similar, or hold the bulb by its base. ◀

## Light-emitting diodes (LEDs)

Light-emitting diodes installed behind a cover serve as the light source for controls, display elements and other equipment.

These light-emitting diodes, which are related to conventional lasers, are officially designated as Class 1 light-emitting diodes.



Do not remove the covers

Do not remove the covers, and never stare into the unfiltered light for several hours; otherwise, irritation of the retina could result. ◀

## Headlamp glass

Condensation can form on the inside of the external lamps in cool or humid weather. When the light is switched on, the condensation evaporates after a short time. The headlamp glasses do not need to be changed.

If there is a large amount of moisture, e.g., water droplets form in the lamp, have it checked by your service center.

## Front lamps, bulb replacement

### At a glance

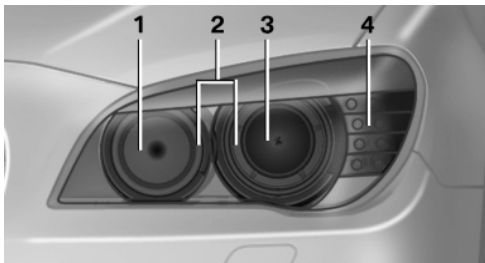

- 1 Adaptive light control
- 2 Parking lamp, daytime running lights\*
- 3 Low beams/high beams
- 4 Turn signal

## Xenon headlamps

Because of the long life of these bulbs, the likelihood of failure is very low. Switching the lamps on and off frequently shortens their life.

If a xenon bulb fails, switch on the front fog lamps and continue the trip with great care. Comply with local regulations.



Do not perform work/bulb replacement on xenon headlamps

Have any work on the xenon lighting system, including bulb replacement, performed only by an authorized dealership.

Due to the high voltage present in the system, there is the danger of fatal injuries if work is carried out improperly. ◀

For checking and adjusting headlamp aim, please contact your BMW center.

## Turn signals, incl. side indicators

Follow the general instructions on [lamps and bulbs](#), refer to [page 239](#).

These lamps are made using LED technology.

Please contact your service center in the event of a malfunction.

## Adaptive light control

Follow the general instructions on [lamps and bulbs](#), refer to [page 239](#).

The illustration shows the left side of the engine compartment.

55-watt bulb, H3

1. Open the folding cover in the engine compartment.

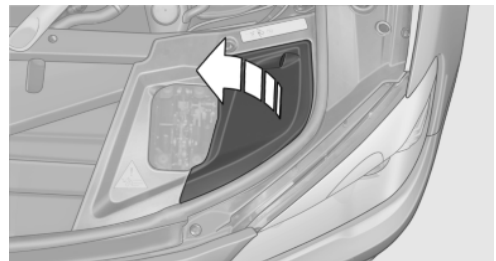



2. Turn the cap and remove it.

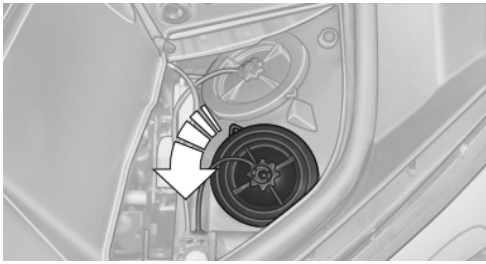

3. Squeeze the holder together and guide it downward.

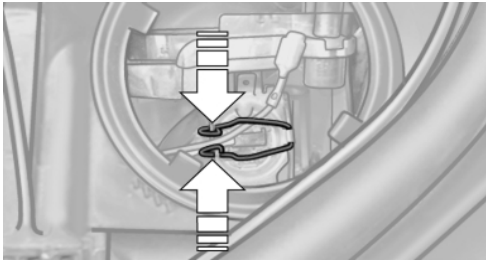

4. Release the holder and fold it upward.
5. Remove the bulb and replace it.
6. Insert the new bulb and attach the cover in the reverse order.

### Parking lamps

Follow the general instructions on [lamps and bulbs](#), refer to [page 239](#).

The illustration shows the left side of the engine compartment.

35-watt bulb, H8

1. Open the folding cover in the engine compartment.

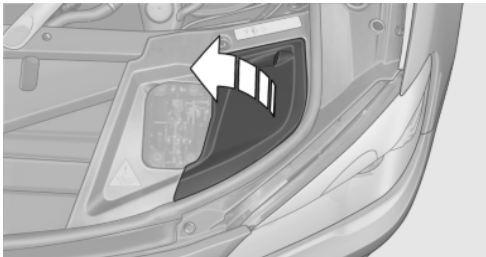

2. Turn the cap and remove it.

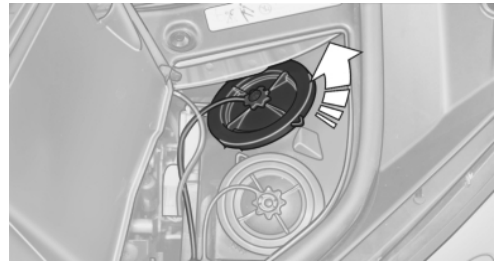

3. Turn the bulb holder.  
Turn in the other direction on the right side.

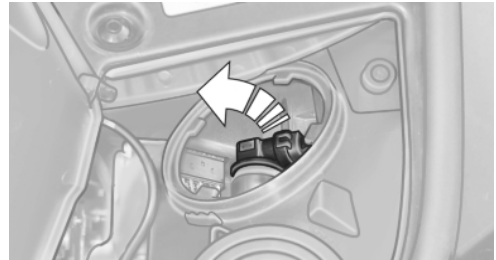

4. Remove the bulb and replace it.
5. Insert the new bulb and attach the cover in the reverse order.

### Front fog lamps

Follow the general instructions on [lamps and bulbs](#), refer to [page 239](#).

35-watt bulb, H8

1. Snap out the grill at the recess, arrow.

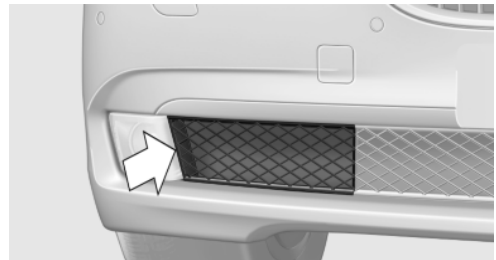

2. Remove the screw using a screw driver.

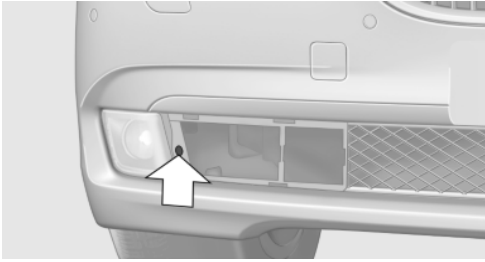

3. Pull the lamp out toward the front.
4. Remove the bulb and replace it.
5. Insert the new bulb and attach the cover in the reverse order.

## Tail lamps, bulb replacement

### At a glance

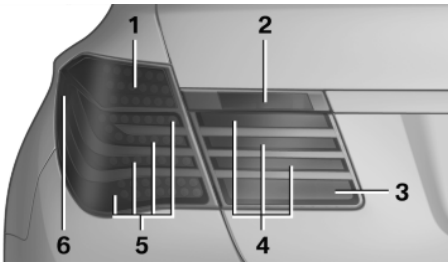

- 1 Turn signal
- 2 Backup lamps
- 3 Rear fog lamp\*
- 4 Tail lamp
- 5 Brake lamp
- 6 Rear reflector\*

## Turn signal, brake, tail, and license plate lamps

Follow the general instructions on [lamps and bulbs](#), refer to [page 239](#).

These lights are made using LED technology.

Contact your service center in the event of a malfunction.

## Rear fog lamp and backup lamps in the trunk lid Backup lamps in the trunk lid

### Accessing the lamps

1. Remove the three screws using the screw driver from the tool kit.

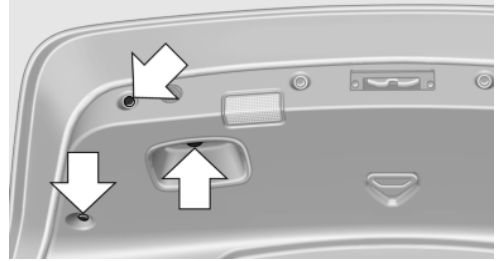

2. Fold away the cover.



3. Replace the defective bulb.

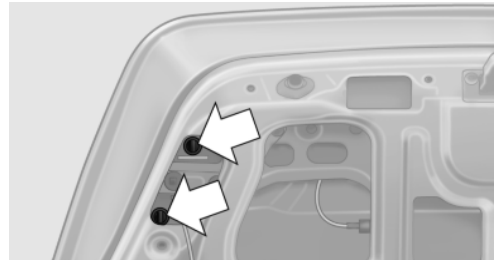

### Rear fog lamps

21-watt bulb, H21W

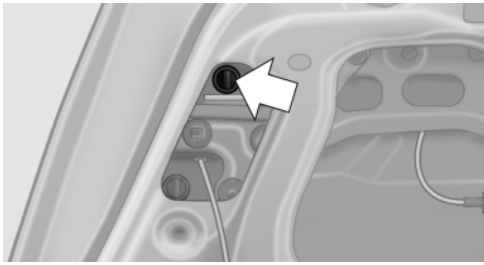

Pull out the bulb and replace it.

### Backup lamps

16-watt bulb, W16W

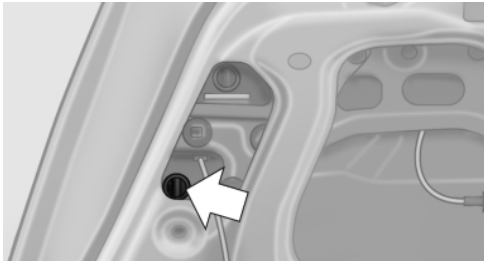

Pull out the bulb and replace it.

## Changing wheels

### Notes

Your BMW is equipped with [run-flat tires](#), refer to [page 231](#), as standard equipment.

They do not need to be replaced immediately in the event of a puncture.

When mounting new tires or changing from summer to winter tires or vice versa, use run-flat tires for your own safety.

No spare tire is available in the case of a flat tire.

The tools for changing wheels are available as accessories from your authorized dealership.

### Jacking points for the vehicle jack

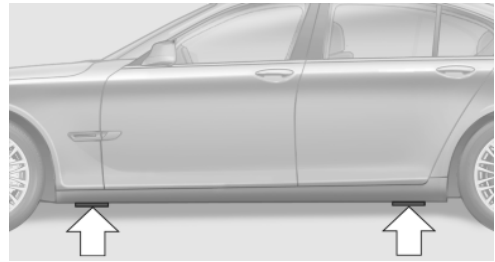

The jacking points for the vehicle jack are located in the positions shown.

### Lug bolt lock\*



The lug bolt lock is found in the tool kit.

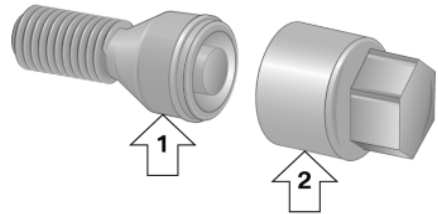

- ▷ Lug bolt, arrow 1.
- ▷ Adapter, arrow 2.

### Removing

1. Attach the adapter to the wheel lug.
2. Unscrew the lug bolt.

Remove the adapter after screwing the lug bolt back on.

## Vehicle battery

### Maintenance

The battery is maintenance-free, i.e., the electrolyte will generally last for the life of the battery. Your service center will be glad to advise you on questions regarding the battery.

### Battery replacement

 Use approved vehicle batteries. Only use vehicle batteries that have been approved for your vehicle by the manufacturer; otherwise, the vehicle could be damaged and systems or functions may not be fully available. ◀

After a battery replacement, have the battery registered on the vehicle by your service center to ensure that all comfort functions are fully available.

### Charging the battery

In the vehicle, only charge the battery via the [terminals](#), refer to [page 246](#), in the engine compartment with the engine off.

### Power failure

After a temporary power loss, some equipment needs to be reinitialized.

Individual settings need to be reprogrammed:

- ▷ Seat, mirror, and steering wheel memory: [store the positions again](#), refer to [page 56](#).
- ▷ Time: [update](#), refer to [page 80](#).
- ▷ Date: [update](#), refer to [page 81](#).
- ▷ Radio station: [store again](#), refer to [page 172](#).
- ▷ Navigation system: wait for the operability of the navigation.

### Disposing of old batteries



Have old batteries disposed of by your service center or hand them in to a recycling center.

Maintain the battery in an upright position for transport and storage. Secure the battery so that it does not tip over during transport.

## Fuses

### Notes

 Replacing fuses  
Never attempt to repair a blown fuse and do not replace a defective fuse with a substitute of another color or amperage rating; this could lead to a circuit overload, ultimately resulting in a fire in the vehicle. ◀

Plastic tweezers and information on the fuse types and locations are stored in the fuse box in the trunk.

### In the glove compartment

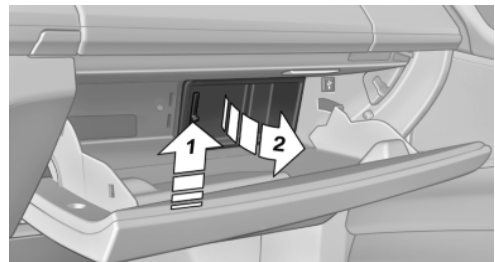

Push the handle up, arrow 1, and open the lid, arrow 2.

### In the trunk

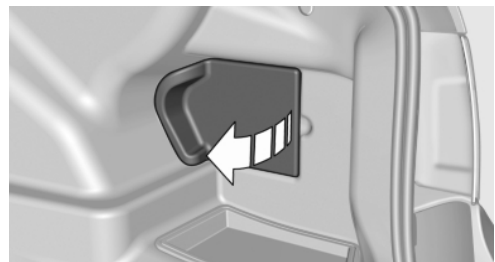

Open the cover on the right side trim. Information on the fuse types and locations is found on a separate sheet.

# Breakdown assistance

## Hazard warning flashers

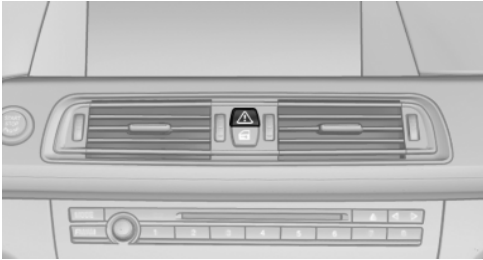

The button for the hazard warning flashers is located in the center console.

## Emergency Request\*

### Requirements

- ▷ Equipment version with full preparation package mobile phone.  
An Emergency Request can be made, even if no mobile phones are paired with the vehicle.
- ▷ [BMW Assist is activated, refer to page 218.](#)
- ▷ The radio ready state is switched on.
- ▷ The BMW Assist system is functional and logged into a wireless communications network.
- ▷ The BMW Assist system is functional.

### Service contract

- ▷ After your contract with BMW Assist has expired, the BMW Assist system can be deactivated by the authorized dealership without you having to visit a workshop.
- ▷ After deactivation, an Emergency Request is no longer possible.
- ▷ The system can be reactivated by an authorized dealership after you sign a new contract.

## Initiating an Emergency Request



1. Press the cover briefly to open it.
2. Press the SOS button until the LED in the button lights up.
  - ▷ The LED lights up: the connection is being established.
  - ▷ The LED flashes if the connection to the BMW Assist Response Center has been established. When a cancel prompt appears on the Control Display, the Emergency Request can be stopped within 5 seconds.

After the Emergency Request arrives at the BMW Assist Response Center, the BMW Assist Response Center contacts you and takes further steps to help you.

Even if you are unable to respond, the BMW Assist Response Center can take further steps to help you under certain circumstances.

Data that are used to determine the necessary rescue measures, such as the current position of the vehicle if it can be established, are transmitted to the BMW Assist Response Center.

- ▷ If the situation allows, wait in your vehicle until the voice connection has been established.
- ▷ If the LED is flashing but the BMW Assist Response Center cannot be heard on the hands-free system, the hands-free system may be malfunctioning. However, the BMW Assist Response Center may still be able to hear you.

- ▷ Under certain conditions, an Emergency Request is automatically initiated immediately after a severe accident. Automatic Collision Notification is not affected by pressing the button.



Emergency Request not guaranteed

For technical reasons, the Emergency Request cannot be guaranteed under unfavorable conditions. ◀

## Warning triangle\*



In a container on the inside of the trunk lid.

Unscrew the wing nut to open.

## First aid kit\*



The first aid kit is located in the container on the inside of the trunk lid.

Unscrew the wing nut to open.

Some of the articles have a limited service life.

Check the expiration dates of the contents regularly and replace any items promptly.

## Roadside Assistance

Roadside Assistance from the BMW Group provides around-the-clock assistance in the event of a breakdown, including on weekends and holidays.

Phone numbers of the Response Center of Roadside Assistance in your home country: refer to the Contact brochure.

## Jump starting

### Notes

If the battery is discharged, an engine can be started using the battery of another vehicle and two jumper cables. Only use jumper cables with fully insulated clamp handles.

To prevent personal injury or damage to both vehicles, adhere strictly to the following procedure.



Do not touch live parts

To avoid the risk of potentially fatal injury, always avoid all contact with electrical components while the engine is running. ◀

### Preparation

1. Check whether the battery of the other vehicle has a voltage of 12 volts and approximately the same capacity in Ah. This information can be found on the battery.
2. Switch off the engine of the assisting vehicle.
3. Switch off any electronic systems/power consumers in both vehicles.



Bodywork contact between vehicles

Make sure that there is no contact between the bodywork of the two vehicles; otherwise, there is the danger of short circuits. ◀

### Starting aid terminals



Connecting order

Connect the jumper cables in the correct order; otherwise, there is the danger of injury from sparking. ◀

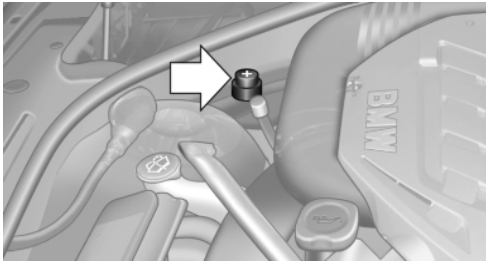

The so-called starting aid terminal in the engine compartment acts as the battery's positive terminal.

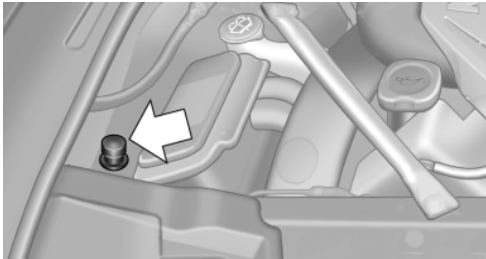

The body ground or a special nut acts as the negative terminal.

### Connecting the cables

1. Pull off the cap of the BMW starting aid terminal.
2. Attach one terminal clamp of the positive jumper cable to the positive terminal of the battery or to the corresponding starting aid terminal of the vehicle providing assistance.
3. Attach the other end of the cable to the positive terminal of the battery or to the corresponding starting aid terminal of the vehicle to be started.
4. Attach one terminal clamp of the negative jumper cable to the negative terminal of the battery or to the corresponding engine or body ground of the vehicle providing assistance.
5. Attach the other end of the cable to the negative terminal of the battery or to the corre-

sponding engine or body ground of the vehicle to be started.

### Starting the engine

Never use spray fluids to start the engine.

1. Start the engine of the assisting vehicle and let it run for several minutes at an increased idle speed.
2. Start the engine of the other vehicle as usual. If the first starting attempt is not successful, wait a few minutes before making another attempt in order to allow the discharged battery to recharge.
3. Let both engines run for several minutes.
4. Disconnect the jumper cables in the reverse order.

Check the battery and recharge if necessary.

### Tow-starting and towing

#### Tow fitting



The screw-in tow fitting should always be carried in the vehicle. It can be screwed in at the front or rear of the BMW. It is located in the container on the inside of the trunk lid.



Tow fitting, information on use

- ▶ Use only the tow fitting provided with the vehicle and screw it all the way in.
- ▶ Use the tow fitting for towing on paved roads only.
- ▶ Avoid lateral loading of the tow fitting, e.g., do not lift the vehicle by the tow fitting.

Otherwise, damage to the tow fitting and the vehicle can occur. ◀

## Screw thread



Push out the cover by pressing on the arrow symbol.

## Towing

### Observe before towing



Light towing vehicle

The towing vehicle must not be lighter than the vehicle being towed; otherwise, it will not be possible to control the vehicle response. ◀



Attaching the tow bar/tow rope correctly

Attach the tow bar or tow rope to the tow fitting; connecting it to other vehicle parts may cause damage. ◀



Manually release the transmission lock

Manually release the transmission lock, even if there is no malfunction involving the transmission. Otherwise, there is the danger that the transmission lock will be engaged automatically during towing. ◀

### Observe during towing



Follow the general instructions

Follow the instructions on towing; otherwise, there is the danger of damage to the vehicle or accidents occurring. ◀

- ▷ Make sure that the ignition is switched on; otherwise, the low beams, tail lamps, turn signals, and windshield wipers may be unavailable.
- ▷ Do not tow the vehicle with the rear axle raised, as the front wheels could turn.

- ▷ When the engine is stopped, there is no power assist. Consequently, more force needs to be applied when braking and steering.
- ▷ Larger steering wheel movements are required.
- ▷ Switch on the hazard warning system, depending on local regulations.
- ▷ If the electrical system has failed, clearly identify the vehicle being towed by placing a sign or a warning triangle in the rear window.



Adhere to the towing speed and distance

Do not exceed a towing speed of 30 mph/ 50 km/h and a towing distance of 30 miles/ 50 km; otherwise, the automatic transmission may be damaged. ◀

### Towing methods



Do not lift the vehicle

Do not lift the vehicle by the tow fitting or body and chassis parts; otherwise, damage may result. ◀

### Tow bar

The tow fittings used should be on the same side on both vehicles.

Should it prove impossible to avoid mounting the tow bar at an offset angle, please observe the following:

- ▷ Maneuvering capability is limited during cornering.
- ▷ The tow bar will generate lateral forces if it is secured with an offset.

### Tow rope

When starting to tow the vehicle, make sure that the tow rope is taut.

To avoid jerking and the associated stresses on the vehicle components when towing, always use nylon ropes or nylon straps.



Attaching the tow rope correctly



Only secure the tow rope on the tow fitting; otherwise, damage can occur when it is secured on other parts of the vehicle. ◀

Have the cause of the starting difficulties remedied.

## Tow truck

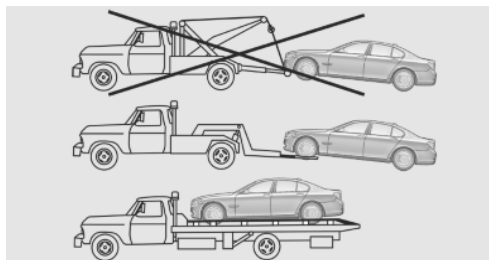

Have your vehicle transported with a tow truck with a so-called lift bar or on a flat bed.

-  Do not lift the vehicle.
- Do not lift the vehicle by the tow fitting or body and chassis parts; otherwise, damage may result. ◀

## Tow truck: xDrive\*

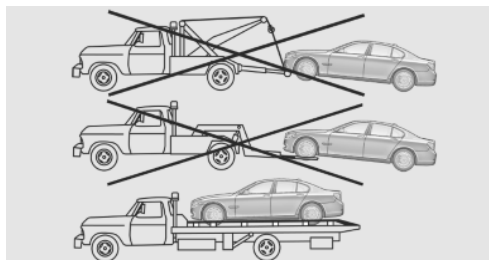

-  Have your vehicle transported on a flatbed surface only.

Do not tow your vehicle with xDrive with just the front or rear axle raised; otherwise, the wheels could lock up and the transfer case could be damaged. ◀

-  Do not lift the vehicle.
- Do not lift the vehicle by the tow fitting or body and chassis parts; otherwise, damage may result. ◀

## Tow-starting

Due to the automatic transmission, the engine cannot be started by tow-starting.

# Care

## Car washes

### Notes

 Steam jets or high-pressure washers  
When using steam jets or high-pressure washers, hold them a sufficient distance away and use a maximum temperature of 140 °F/ 60 °C.

Holding them too close or using excessively high pressures or temperatures can cause damage or preliminary damage that may then lead to long-term damage.

Follow the operating instructions for the high-pressure washer. ◀

 Cleaning sensors/cameras with high-pressure washers

When using high-pressure washers, do not spray the exterior sensors and cameras, e.g., Park Distance Control\*, for extended periods of time and only from a distance of at least 12 in/ 30 cm. ◀

Wash your vehicle frequently, particularly in winter.

Intense soiling and road salt can damage the vehicle.

### Washing in automatic car washes

Your BMW can be washed in automatic car washes right from the start.

Give preference to cloth car washes or those that use soft brushes in order to avoid paint damage.

### Notes

Note the following:

- ▷ Make sure that the wheels and tires are not damaged by the transport mechanisms.
- ▷ Fold in the exterior mirrors; otherwise, they may be damaged, depending on the width of the vehicle.

- ▷ Deactivate the [rain sensor, refer to page 70](#), to avoid unintentional wiper activation.

 Guide rails in car washes  
Avoid car washes with guide rails higher than 4 in/10 cm; otherwise, the vehicle body could be damaged. ◀

### Before driving into a car wash

The vehicle is able to roll when the following steps are taken:

1. Depress the brake pedal.
2. Engage transmission position N.
3. Release the [parking brake, refer to page 66](#), or deactivate [Automatic Hold, refer to page 68](#).
4. Switch the engine off.

 Transmission position P with the ignition off

When the ignition is switched off, position P is engaged automatically. When in an automatic car wash, for example, ensure that the ignition is not switched off accidentally. ◀

The vehicle cannot be locked from the outside when in transmission position N.

A signal is sounded when an attempt is made to lock the vehicle.

### Transmission position

Transmission position P is engaged automatically:

- ▷ When the ignition is switched off.
- ▷ After approx. 15 minutes.

### Headlamps

- ▷ Do not rub dry and do not use abrasive or caustic cleansers.
- ▷ Soak areas that have been soiled e.g. due to insects, with shampoo and wash off with water.

- ▶ Thaw ice with de-icing spray; do not use an ice scraper.

## After washing the vehicle

After washing the vehicle, apply the brakes briefly to dry them; otherwise, braking action can be reduced and corrosion of the brake discs can occur.

## Vehicle care

### Car care products

BMW recommends using cleaning and care products from BMW, since these have been tested and approved.



Car care and cleaning products

Follow the instructions on the container.

When cleaning the interior, open the doors or windows.

Only use products intended for cleaning vehicles.

Cleansers can contain substances that are dangerous and harmful to your health.◀

### Vehicle paint

Regular care contributes to driving safety and value retention.

Environmental influences can act on the vehicle paint. Tailor the frequency and extent of your car care to these influences.

### Leather care

Remove dust from the leather often, using a cloth or vacuum cleaner.

Otherwise, particles of dust and road grime chafe in pores and folds, and lead to increased wear and premature degradation of the leather surface.

Treat the leather twice a year with a leather care product, since dirt and grease slowly break down the protective layer of the leather.

### Upholstery material care

Vacuum regularly with a vacuum cleaner.

If they are very dirty, e.g., beverage stains, use a soft sponge or microfiber cloth with a suitable interior cleaner.

Clean the upholstery down to the seams using large sweeping motions. Avoid rubbing the material vigorously.



Damage from Velcro® fasteners

Open Velcro® fasteners on pants or other articles of clothing can damage the seat covers. Ensure that any Velcro® fasteners are closed.◀

### Caring for special components

#### Light-alloy wheels

Use wheel cleaner, particularly during the winter months. Do not use aggressive, acidic, strongly alkaline or abrasive cleaners, or steam jets above 140 °F/60 °C; follow the manufacturer's instructions.

#### Chrome surfaces\*

Carefully clean components such as the radiator grille or door handles with an ample supply of water, possibly with shampoo added, particularly when they have been exposed to road salt.

#### Rubber components

Aside from water, treat only with rubber cleansers.

When cleaning rubber seals, do not use any silicon-containing car care products in order to avoid damage or reduced noise damping.

#### Fine wood parts\*

Clean fine wood facing and fine wood components only with a moist rag. Then dry with a soft cloth.

#### Plastic components

These include:

- ▶ Imitation leather surfaces.
- ▶ Headliner.
- ▶ Lamp lenses.
- ▶ Instrument cluster cover.

- ▷ Matte black spray-coated components.

Clean with a microfiber cloth.

Moisten the cloth lightly and use plastic cleanser, if necessary.

Do not soak the headliner.



Do not use cleansers that contain alcohol or solvents

Do not use cleansers that contain alcohol or solvents, such as lacquer thinners, heavy-duty grease removers, fuel, or such; this could lead to surface damage.◀

## Safety belts

Dirty belt straps impede the reeling action and thus have a negative impact on safety.



Chemical cleaning

Do not clean chemically; this can destroy the webbing.◀

Use only a mild soapy solution, with the safety belts clipped into their buckles.

Do not allow the reels to retract the safety belts until they are dry.

## Carpets and floor mats\*

Floor mats can be removed from the passenger compartment for cleaning.

If they are very dirty, clean with a microfiber cloth and water or an interior cleaner. To prevent matting of the carpet, rub back and forth in the direction of travel only.

## Sensors/cameras

To clean the sensors or cameras of equipment such as the high-beam assistant\*, Active Cruise Control\* or Night Vision\*, use a cloth moistened with a small amount of glass cleaner.

## Displays/screens

Use a microfiber cloth to clean the Control Display or the Head-up Display\*.



Cleaning displays

Do not use chemical or household cleansers.

Keep all fluids and moisture away from the unit.

Otherwise, they could affect or damage surfaces or electrical components.

Avoid pressing too hard when cleaning and do not use abrasive materials; otherwise, damage can result.◀

## Long-term vehicle storage

Your service center can advise you on what to consider when storing the vehicle for longer than three months.





## Reference

This chapter contains technical data, short commands for the voice activation system, and an index that will quickly take you to the information you need.

# Technical data

## Dimensions

### Width with mirrors, height

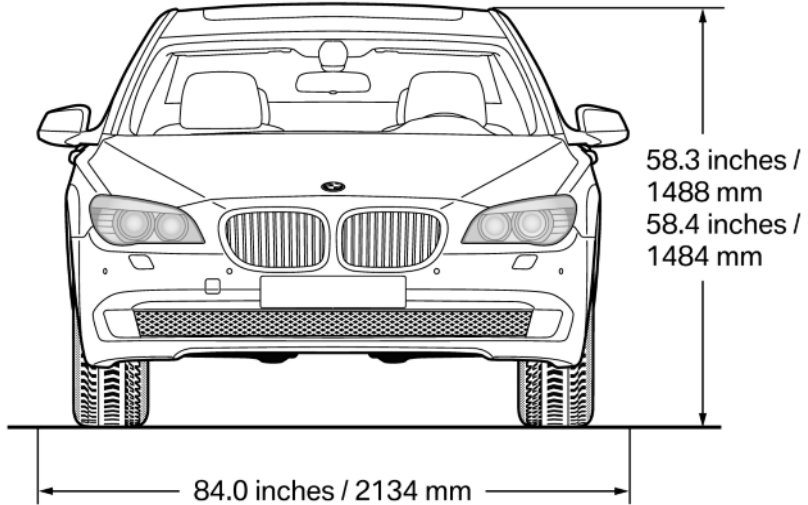

The two bottom values apply to L models.

Height 760i: 58.2 inches/1,479 mm / 760Li:  
58.7 inches/1,490 mm



## Width without mirrors

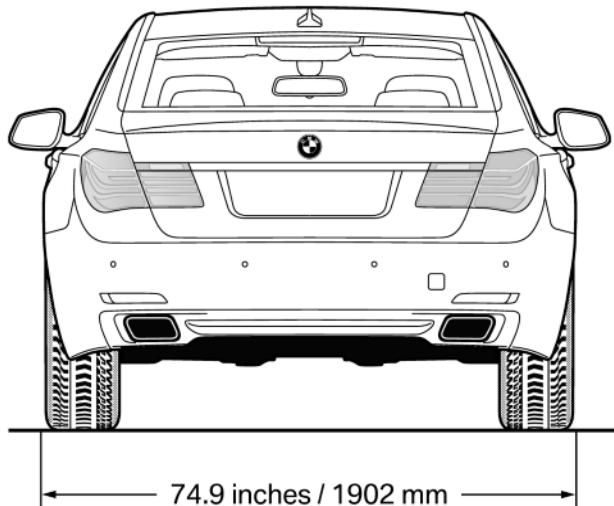

## Length, wheel base

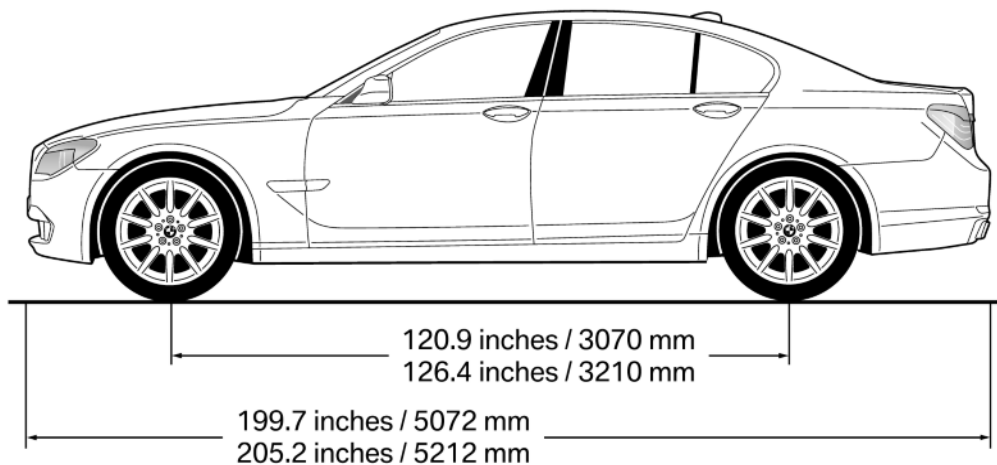

The bottom values apply to L models.

## Smallest turning circle

Ø: 40 ft/12.2 m

L model Ø: 41 ft 6 in/12.7 m

## Engine specifications

The rated power outputs are established on the basis of fuel grade AKI 91.

750i/Li		
Displacement	cu in/cm <sup>3</sup>	268.2/4,395
No. of cylinders		8
Maximum output at engine speed	hp rpm	400 5,500-6,400
Maximum torque at engine speed	lb ft/Nm rpm	450/610 1,750-4,500

750i xDrive/750Li xDrive		
Displacement	cu in/cm <sup>3</sup>	268.2/4,395
No. of cylinders		8
Maximum output at engine speed	hp rpm	400 5,500-6,400
Maximum torque at engine speed	lb ft/Nm rpm	450/610 1,750-4,500

760Li		
Displacement	cu in/cm <sup>3</sup>	364.3/5,972
No. of cylinders		12
Maximum output at engine speed	hp rpm	537 5,250
Maximum torque at engine speed	lb ft/Nm rpm	553.2/750 1,500-5,000

## Weights

		750i	750Li
Approved gross vehicle weight	lbs/kg	5,698/2,585	5,787/2,625
Load	lbs/kg	1,058/480	1,058/480
Approved front axle load	lbs/kg	2,788/1,265	2,832/1,285

		750i	750Li
Approved rear axle load	lbs/kg	3,053/1,385	3,119/1,415
Approved roof load capacity	lbs/kg	220/100	220/100
Trunk capacity	cu ft/l	17.7/500	17.7/500

		750i xDrive	750Li xDrive
Approved gross vehicle weight	lbs/kg	5,864/2,660	5,930/2,690
Load	lbs/kg	1,389/630	1,389/630
Approved front axle load	lbs/kg	2,943/1,335	2,976/1,350
Approved rear axle load	lbs/kg	3,116/1,415	3,164/1,435
Approved roof load capacity	lbs/kg	220/100	220/100
Trunk capacity	cu ft/l	17.7/500	17.7/500

		760Li
Approved gross vehicle weight	lbs/kg	6,150/2,790
Load	lbs/kg	947/430
Approved front axle load	lbs/kg	3,119/1,415
Approved rear axle load	lbs/kg	3,196/1,450
Approved roof load capacity	lbs/kg	220/100
Trunk capacity	cu ft/l	17.7/500

## Capacities

			Notes
Fuel tank	US gal/liters	Approx. 21.6/82	Fuel quality, refer to page 225
Windshield and headlamp washer system	US quarts/liters	Approx. 5.3/5.0	

# Short commands for voice activation system

## Useful short commands

Function	Command
Owner's Manual	›Owner's Manual‹
Opening the music collection	›Music collection‹
Opening the tone settings	›Tone‹
Opening the settings	›Settings‹
Opening the profiles	›Profiles‹
Opening the computer	›Onboard info‹
Opening the contacts	›Contacts‹
Displaying the phone book	›Phonebook‹
Opening BMW Assist	›B M W Assist‹
Opening the destination input	›Enter address‹

## CD/multimedia

### CD/DVD drive

Function	Command
Playing back a CD	›C D on‹
Selecting a CD	›Select C D‹
Selecting a CD and track	›C D ... track ... ‹ e.g., CD 3 track 5
Selecting a track	›C D track ... ‹ e.g., track 5
Opening the CD and multimedia menu	›C D and multimedia‹
CD and DVD	›C D and D V D‹
Displaying entertainment details on the split screen	›Entertainment details‹

## Music collection

Function	Command
Calling up the current playback	›Current playback‹
Opening the music collection	›Music collection‹
Playing the music collection	›Music collection on‹
Searching for music; opening the menu	›Music search‹
Selecting a genre	›Select genre‹
Selecting an artist	›Select artist‹
Selecting an album	›Select album‹
Selecting a track	›Select title‹
Selecting a track directly*	›Title ... ‹
Starting playback	›Start play‹
Playing back the most frequently played tracks	›Top fifty‹

## External devices

Function	Command
Opening external devices	›External devices‹
AUX front	›AUX front‹

## Tone

Function	Command
Opening the tone settings	›Tone‹

## Radio

### FM

Function	Command
Calling up the radio	›Radio‹
Calling up an FM station	›F M‹
Opening manual search	›Manual search‹

Function	Command
Calling up a frequency	›Frequency ... megahertz‹ e.g., 93.5 megahertz or frequency 93.5
Selecting the frequency range	›Select frequency‹

## AM

Function	Command
Calling up an AM station	›A M‹
Opening manual search	›Manual search‹
Calling up a frequency	›Frequency ... Kiloherzt‹ e.g., frequency 753 or 753 kilohertz

## Weather Band

Function	Command
Calling up the Weather Band	›Weather band‹
Switching on the Weather Band	›Weather band on‹
Selecting a Weather Band station	›Select a weather channel‹

## Satellite radio

Function	Command
Calling up the satellite radio	›Satellite radio‹
Switching on the satellite radio	›Satellite radio on‹
Selecting a satellite radio channel	›Satellite radio channel ... ‹ e.g., satellite radio channel 2

## Stored stations

Function	Command
Opening the stored stations	›Presets‹
Choosing a stored station	›Select preset‹
Selecting a stored station	›Preset ... ‹ e.g., stored station 2

# Telephone

Function	Command
Opening the Telephone menu	›Telephone‹
Displaying the phone book	›Phonebook‹
Redialing	›Redial‹
Displaying accepted calls	›Received calls‹
Dialing a phone number	›Dial number‹
List of messages	›Messages‹
Bluetooth devices	›Bluetooth‹

## Navigation

### General information

Function	Command
Navigation menu	›Navigation‹
Opening the destination input	›Enter address‹
Entering the address	›Enter address‹
Opening destination guidance	›Guidance‹
Starting destination guidance	›Start guidance‹
Terminating destination guidance	›Stop guidance‹
Opening the home address	›Home address‹
Opening the route criteria	›Route preference‹
Opening the route	›Route information‹
Switching on the spoken instructions	›Switch on voice instructions‹
Repeating a spoken instruction	›Repeat voice instructions‹
Switching off the spoken instructions	›Switch off voice instructions‹
Displaying the address book	›Address book‹
Displaying the last destinations	›Last destinations‹
Opening the traffic bulletins	›Traffic Info‹
Special destinations	›Points of interest‹

## Map

Function	Command
Displaying the map	›Map‹
Map facing north	›Map facing north‹
Map in the direction of travel	›Map in direction of travel‹
Perspective map	›Map perspective view‹
Automatic scaling of the map	›Map with automatic scaling‹
Scale...feet	›Map scale ... feet‹
Scale...miles	›Map scale ... miles‹ e.g., map scale 5 miles

## Split screen settings

Function	Command
Split screen	›Switch on splitscreen‹
Switching off the split screen	›Turn off split screen‹
Adapting the split screen	›Split screen content‹
Split screen, map facing north	›Split screen map facing north‹
Split screen, current position	›Split screen current position‹
Split screen, direction of travel	›Split screen map in direction of travel‹
Split screen, perspective	›Split screen perspective‹
Split screen, wider intersection zoom	›Splitscreen Exit ramp view‹
Split screen scale...feet	›Split screen scale ... feet‹ e.g., split screen scale 100 feet
Split screen scale...miles	›Split screen scale ... miles‹ e.g., split screen scale 5 miles
Split screen, highlighting traffic bulletins	›Split screen, Traffic Info map‹
Split screen, computer	›Split screen on board info‹
Split screen, trip computer	›Splitscreen trip computer‹



## Destination guidance with intermediate destinations

Function	Command
New destination entry	›Enter address‹
Trip list	›Stored trips‹

## Contacts

Function	Command
My contacts	›My contacts‹
Opening the contacts	›Contacts‹
New contact	›New contact‹

## BMW Assist

Function	Command
Opening BMW Assist*	›B M W Assist‹

## Vehicle information

### Owner's Manual

Function	Command
Opening the Owner's Manual	›Display Owner's Manual‹
Opening the Quick Reference	›Quick reference‹
Opening the keyword search	›Owner's Manual‹
Opening Search by pictures	›Search by pictures‹

### Computer

Function	Command
Opening the computer	›Onboard info‹
Opening the trip computer	›Trip computer‹

## Vehicle

Function	Command
Opening the vehicle information	›Vehicle info‹
Opening the vehicle status	›Vehicle status‹

## Adjusting

### Vehicle

Function	Command
Opening the main menu	›Main menu‹
Opening the settings	›Settings‹
Opening the options	›Options‹
Info display of the instrument cluster	›Info Display‹
Central display settings	›Control display‹
Opening the time and date settings	›Time and date‹
Opening the language and unit settings	›Language and units‹
Opening the speed limit settings	›Speed‹
Opening the light settings	›Lighting‹
Opening the door lock settings	›Door locks‹
Opening the profiles	›Profiles‹

### Equipment

Function	Command
Opening the air conditioning settings	›Climate‹
Opening the Head-up Display* settings	›head up display‹
Enabling the rear seat*	›Allow rear control‹



# Everything from A to Z

## Index

### A

- ABS, Antilock Brake System **100**
- ACC Active Cruise Control with Stop & Go **107**
- Accessories and parts **7**
- Activated-charcoal filter **128**
- Active Blind Spot Detection **98**
- Active Cruise Control with Stop & Go ACC **107**
- Active seat, front **49**
- Active seat, rear **51**
- Active seat ventilation, front **49**
- Active seat ventilation, rear **52**
- Active Steering, integral **102**
- Adaptive brake assistant **100**
- Adaptive brake lights, refer to Brake force display **99**
- Adaptive light control **86**
- Adaptive light control, bulb replacement **240**
- Additives, oil **235**
- Adjustments, seats/head restraints **47**
- After washing vehicle **251**
- Airbags **90**
- Air circulation, refer to Recirculated-air mode **127**
- Air distribution, manual **126**
- Air drying, refer to Cooling function **128**
- Air pressure, tires **226**
- Air vents, refer to Ventilation **129**
- Air volume, automatic climate control **127**
- Alarm system **41**
- Alarm, unintentional **42**
- All around the center console **17**
- All around the headliner **18**
- All around the steering wheel **12**
- ALL program, automatic climate control **128**
- All-season tires, refer to Winter tires **230**
- All-wheel-drive **101**
- Alternating-code hand-held transmitter **134**
- Alternative oil types **235**
- AM/FM station **172**
- Announcement, navigation, refer to Spoken instructions **163**
- Antifreeze, washer fluid **71**
- Antilock Brake System, ABS **100**
- Anti-slip control, refer to DSC **100**
- Approved engine oils **235**
- Armrest, refer to Center armrest **140**
- Arrival time **79**
- Ashtray **135**
- Assist **216**
- Assistance, Roadside Assistance **246**
- Assistance when driving off **105**
- Audio playback **179**
- Authorized dealership **220**
- AUTO intensity **127**
- Automatic car wash **250**
- Automatic climate control **126**
- Automatic Cruise Control with Stop & Go **107**
- Automatic Curb Monitor **57**
- Automatic deactivation, front passenger airbags **91**
- Automatic headlamp control **86**
- Automatic Hold **67**
- Automatic locking **38**
- Automatic recirculated-air control **127**
- Automatic Soft Closing **38**
- Automatic Soft Closing, doors **38**
- Automatic Soft Closing, trunk lid **39**
- Automatic transmission with Steptronic **71**
- Automatic trunk lid **39**
- AUTO program, automatic climate control **127**
- AUTO program, intensity **127**
- AUX-IN port **189**
- Average fuel consumption **78**
- Average speed **78**
- Axle loads, weights **258**

### B

- Backrest curvature, refer to Lumbar support **48**
- Backrest, seats **47**
- Backrest width **48**
- Back seats, adjusting **50**
- Backup camera **118**
- Backup lamps, bulb replacement **242**
- Balance **170**
- Band-aids, refer to First aid kit **246**
- Bar for tow-starting/towing **248**
- Basic position, rear seats **51**
- Bass **170**
- Battery replacement, remote control, rear entertainment **194**

Battery replacement, vehicle remote control [32](#)  
Battery, vehicle [244](#)  
Before entering the car wash [250](#)  
Belts, safety belts [52](#)  
Beverage holder, cup holder [141](#)  
Blinds, sun protection [44](#)  
Bluetooth connection, activating/deactivating [207](#)  
BMW Assist [216](#)  
BMW EfficientDynamics, refer to Saving fuel [150](#)  
BMW homepage [6](#)  
BMW Internet page [6](#)  
BMW Maintenance System [237](#)  
BMW Search [218](#)  
Bottle holder, refer to Cup holder [141](#)  
Brake assistant [100](#)  
Brake assistant, adaptive [100](#)  
Brake discs, breaking in [146](#)  
Brake force display [99](#)  
Brake lamp, center [242](#)  
Brake lamps, brake force display [99](#)  
Brake lamps, bulb replacement [242](#)  
Brake lights, adaptive [99](#)  
Brake pads, breaking in [146](#)  
Braking, notes [147](#)  
Breakdown assistance [245](#), [246](#)  
Breaking in [146](#)  
Brightness of Control Display [82](#)  
Bulb replacement [239](#)  
Bulb replacement, front [240](#)  
Bulb replacement, rear [242](#)  
Bulbs and lamps [239](#)  
Button, Start/Stop [64](#)

## C

California Proposition 65 Warning [7](#)

Camera, backup camera [120](#)  
Camera, care [252](#)  
Camera, Side View [121](#)  
Can holder, refer to Cup holder [141](#)  
Car battery [244](#)  
Car care products [251](#)  
Care, vehicle [251](#)  
Cargo [148](#)  
Cargo straps, securing cargo [149](#)  
Car key, refer to Remote control [32](#)  
Carpet, care [252](#)  
Car wash [250](#)  
Catalytic converter, refer to Hot exhaust system [146](#)  
Category details, special destinations [157](#)  
CBS Condition Based Service [237](#)  
CD/DVD [179](#)  
CD/DVD player, rear [193](#), [198](#)  
CDs, storing [185](#)  
Cell phone [206](#)  
Center armrest [140](#)  
Center brake lamp [242](#)  
Center console [17](#)  
Central locking system [35](#)  
Central screen, refer to Control Display [19](#)  
Changes, technical, refer to Safety [6](#)  
Changing parts [239](#)  
Changing wheels/tires [229](#)  
Check Control [83](#)  
Children, seating position [60](#)  
Children, transporting safely [60](#)  
Child restraint fixing system [60](#)  
Child restraint fixing system LATCH [61](#)  
Child restraint fixing systems, mounting [60](#)  
Child-safety locks [63](#)  
Child seat, mounting [60](#)  
Child seats [60](#)

Chrome parts, care [251](#)  
Cigarette lighter [135](#)  
Climate control [126](#)  
Climate control on headliner [131](#)  
Climate control windshield [147](#)  
Clock [76](#)  
Closing/opening from inside [37](#)  
Closing/opening via door lock [37](#)  
Closing/opening with remote control [35](#)  
Clothes hooks [142](#)  
Collision warning, iBrake [112](#)  
Combination instrument [14](#)  
Combination instrument, electronic displays [16](#)  
Combination switch, refer to Turn signals [69](#)  
Combination switch, refer to Wiper system [69](#)  
Comfort Access [40](#)  
Comfort opening [36](#)  
COMFORT program, Dynamic Driving Control [105](#)  
Computer [78](#)  
Concierge service [217](#)  
Condensation on windows [127](#)  
Condensation under the vehicle [148](#)  
Condition Based Service CBS [237](#)  
Confirmation signal [36](#)  
Contacts [214](#)  
Control Display [19](#)  
Control Display, care [252](#)  
Control Display, settings [80](#)  
Controller [19](#)  
Control systems, driving stability [100](#)  
Convenience operation [37](#)  
Coolant [236](#)  
Coolant temperature [76](#)  
Cooler [136](#)  
Cooling function [128](#)

Cooling, maximum [127](#)  
 Cooling system [236](#)  
 Corrosion on brake discs [148](#)  
 Cruise control [113](#)  
 Cruise control, active with  
 Stop & Go [107](#)  
 Cruising range [77](#)  
 Cup holder [141](#)  
 Curb weight [258](#)  
 Current fuel consumption [76](#)  
 Current location, storing [156](#)  
 Customer Relations [219](#)

## D

Damage, tires [229](#)  
 Damping Control, dynamic [102](#)  
 Data, technical [256](#)  
 Date [76](#)  
 Daytime running lights [86](#)  
 Defrosting, refer to Windows, defrosting [127](#)  
 Destination distance [79](#)  
 Destination guidance [161](#)  
 Destination guidance with intermediate destinations [160](#)  
 Destination input, navigation [154](#)  
 Detour, selecting [166](#)  
 Digital clock [76](#)  
 Digital radio [173](#)  
 Dimensions [256](#)  
 Dimmable mirrors [58](#)  
 Direction indicator, refer to  
 Turn signals [69](#)  
 Displacement, engine [258](#)  
 Display, instrument cluster [75](#)  
 Display in windshield [124](#)  
 Display lighting, refer to Instrument lighting [88](#)  
 Displays [14](#)  
 Displays, care [252](#)  
 Disposal, coolant [236](#)  
 Disposal, vehicle battery [244](#)  
 Distance control, refer to  
 PDC [115](#)

Distance, selecting for  
 ACC [108](#)  
 Distance to destination [79](#)  
 Divided screen view, split  
 screen [23](#)  
 Door lock, refer to Remote  
 control [32](#)  
 Doors, Automatic Soft Closing [38](#)  
 Downhill control [101](#)  
 Drive-off assistant [105](#)  
 Drive-off assistant, refer to  
 DSC [100](#)  
 Driving instructions, breaking  
 in [146](#)  
 Driving notes, general [146](#)  
 Driving stability control systems [100](#)  
 Driving tips [146](#)  
 DSC Dynamic Stability Control [100](#)  
 DTC Dynamic Traction Control [100](#)  
 DVD/CD [179](#)  
 DVD/CD notes [184](#)  
 DVD/CD player, rear [193](#), [198](#)  
 DVD changer [183](#)  
 DVD settings [182](#)  
 DVDs, storing [185](#)  
 DVD, video [181](#)  
 Dynamic Damping Control [102](#)  
 Dynamic destination guidance [162](#)  
 Dynamic Drive [102](#)  
 Dynamic Driving Control [103](#)  
 Dynamic Stability Control  
 DSC [100](#)  
 Dynamic Traction Control  
 DTC [100](#)

## E

EfficientDynamics, refer to  
 Saving fuel [150](#)  
 Electronic displays, instrument cluster [16](#)

Electronic engine oil level  
 check [235](#)  
 Electronic Stability Program  
 ESP, refer to DSC [100](#)  
 Emergency detection, remote  
 control [33](#)  
 Emergency release, door  
 lock [37](#)  
 Emergency release, fuel filler  
 door [224](#)  
 Emergency release, parking  
 brake [66](#)  
 Emergency release, transmission lock [73](#)  
 Emergency Request [245](#)  
 Emergency service, refer to  
 Roadside Assistance [246](#)  
 Emergency start function, engine start [33](#)  
 Emergency unlocking, trunk  
 lid [40](#)  
 Energy Control [76](#)  
 Energy recovery [77](#)  
 Engine compartment [233](#)  
 Engine compartment, working  
 in [233](#)  
 Engine coolant [236](#)  
 Engine oil [235](#)  
 Engine oil, adding [235](#)  
 Engine oil additives [235](#)  
 Engine oil filler neck [235](#)  
 Engine oil temperature [76](#)  
 Engine oil types, alternative [235](#)  
 Engine oil types, approved [235](#)  
 Engine specifications [258](#)  
 Engine start, assistance [246](#)  
 Engine start during malfunction [33](#)  
 Engine start, refer to Starting  
 the engine [64](#)  
 Engine stop [65](#)  
 Engine temperature [76](#)  
 Entering/exiting vehicle, assistance, steering wheel [58](#)  
 Equalizer [170](#)  
 Equipment, interior [133](#)

ESP Electronic Stability Program, refer to DSC [100](#)  
Exchanging wheels/tires [229](#)  
Exhaust system [146](#)  
Exterior mirrors [56](#)  
External devices [189](#)  
External temperature display [75](#)  
External temperature warning [75](#)  
Eyes for securing cargo [149](#)

## F

Fader [170](#)  
Failure message, refer to Check Control [83](#)  
False alarm, refer to Unintentional alarm [42](#)  
Fan, refer to Air volume [127](#)  
Fault displays, refer to Check Control [83](#)  
Filler neck for engine oil [235](#)  
Fine wood, care [251](#)  
First aid kit [246](#)  
Fitting for towing, refer to Tow fitting [247](#)  
Flat Tire Monitor FTM [95](#)  
Flat tire, Tire Pressure Monitor TPM [92](#)  
Flat tire, warning lamp [93](#), [96](#)  
Flat tire, wheel change [243](#)  
Flooding [147](#)  
Floor carpet, care [252](#)  
Floor mats, care [252](#)  
FM/AM station [172](#)  
Fold-out position, windshield wipers [71](#)  
Foot brake [147](#)  
Front airbags [90](#)  
Front fog lamps [88](#)  
Front fog lamps, front, bulb replacement [241](#)  
Front lamps [240](#)  
Front passenger airbags, automatic deactivation [91](#)  
Front passenger airbags, indicator lamp [92](#)

Front passenger seat, adjusting [48](#)  
Front seats, adjusting [47](#)  
FTM Flat Tire Monitor [95](#)  
Fuel cap [224](#)  
Fuel consumption, current [76](#)  
Fuel consumption, refer to Average fuel consumption [78](#)  
Fuel filler door [224](#)  
Fuel gauge [77](#)  
Fuel quality [225](#)  
Fuel, tank capacity [259](#)  
Fuse [244](#)

## G

Garage door opener, refer to Integrated universal remote control [133](#)  
Gas station recommendation [163](#)  
Gear change, automatic transmission [72](#)  
General driving notes [146](#)  
Gentleman function [48](#)  
Glass sunroof, powered [45](#)  
Glove compartment [139](#)  
GPS navigation, refer to Navigation system [154](#)  
Gross vehicle weight, approved [258](#)  
Gross weight, permissible for trailer towing [258](#)

## H

Hand brake, refer to Parking brake [65](#)  
Hand-held transmitter, alternating code [134](#)  
Hazard warning flashers [245](#)  
HDC Hill Descent Control [101](#)  
HD Radio [173](#)  
Head airbags [90](#)  
Headlamp control, automatic [86](#)

Headlamp courtesy delay feature [85](#)  
Headlamp courtesy delay feature via remote control [36](#)  
Headlamp flasher [69](#)  
Headlamp glass [240](#)  
Headlamps [240](#)  
Headlamps, care [250](#)  
Headlamp washer system [69](#)  
Headliner [18](#)  
Headphones, rear entertainment [196](#), [201](#)  
Head restraints [47](#)  
Head restraints, front [53](#)  
Head restraints, rear [54](#)  
Head-up Display [124](#)  
Head-up Display, care [252](#)  
Heavy cargo, stowing [149](#)  
Height, seats [47](#)  
Height, vehicle [256](#)  
High-beam assistant [87](#)  
High beams [69](#)  
High beams/low beams, refer to High-beam assistant [87](#)  
Hill Descent Control HDC [101](#)  
Hills [147](#)  
Hill start assistant, refer to Drive-off assistant [105](#)  
Holder for beverages [141](#)  
Homepage [6](#)  
Hood [233](#)  
Horn [12](#)  
Hotel function, trunk lid [40](#)  
Hot exhaust system [146](#)  
House number, entering for navigation [155](#)  
HUD, Head-up Display [124](#)  
Hydroplaning [147](#)

## I

iBrake, collision warning [112](#)  
Ice warning, refer to External temperature warning [75](#)  
Icy roads, refer to External temperature warning [75](#)  
Identification marks, tires [227](#)

Identification number, refer to  
   Engine compartment **233**  
 iDrive **19**  
 Ignition key, refer to Remote control **32**  
 Ignition off **64**  
 Ignition on **64**  
 Indication of a flat tire **93, 96**  
 Indicator and warning messages **14**  
 Indicator lamps **14**  
 Individual air distribution **126**  
 Individual settings, refer to Personal Profile **33**  
 Inflation pressure monitor, tires **92**  
 Inflation pressure, tires **226**  
 Inflation pressure warning, tires **95**  
 Info display **75**  
 Information on navigation data **167**  
 Initialization, Integral Active Steering **103**  
 Initializing, FTM Flat Tire Monitor **95**  
 Initializing, Tire Pressure Monitor TPM **93**  
 Instrument cluster **14, 75**  
 Instrument cluster, electronic displays **16**  
 Instrument lighting **88**  
 Integral Active Steering **102**  
 Integrated key **32**  
 Integrated universal remote control **133**  
 Intensity, AUTO program **127**  
 Interactive map **159**  
 Interior equipment **133**  
 Interior lamps **88**  
 Interior lamps via remote control **36**  
 Interior motion sensor **42**  
 Interior rearview and exterior mirrors, automatic dimming feature **58**  
 Interior rearview mirror **57**

Intermediate destinations **160**  
 Internet page **6**  
 Intersection, entering for navigation **155**  
 Interval display, service requirements **82**  
 iPod/iPhone **190**

## J

Jacking points for the vehicle jack **243**  
 Jack, refer to Vehicle jack **243**  
 Joystick, automatic transmission **72**  
 Jump starting **246**

## K

Key/remote control **32**  
 Keyless-Go, refer to Comfort Access **40**  
 Key Memory, refer to Personal Profile **33**  
 Kick-down, automatic transmission **72**  
 Knee airbag **90**

## L

Lamp replacement **239**  
 Lamp replacement, front **240**  
 Lamp replacement, rear **242**  
 Lamps **85**  
 Lamps and bulbs **239**  
 Lane departure warning **96**  
 Lane margin, warning **96**  
 Language on Control Display **81**  
 Lashing eyes, securing cargo **149**  
 LATCH child restraint fixing system **61**  
 Leather, care **251**  
 LEDs, light-emitting diodes **240**

Length, vehicle **257**  
 License plate lamp, bulb replacement **242**  
 Light-alloy wheels, care **251**  
 Light control **86**  
 Light-emitting diodes, LEDs **240**  
 Lighter, front **135**  
 Lighter, rear **135**  
 Lighting **85**  
 Lighting via remote control **36**  
 Light switch **85**  
 Load **149**  
 Loading **148**  
 Lock, door **37**  
 Locking/unlocking from inside **37**  
 Locking/unlocking via door lock **37**  
 Locking/unlocking with remote control **35**  
 Locking, automatic **38**  
 Locking, central **35**  
 Locking via trunk lid **39**  
 Lock, power window **44**  
 Locks, doors, and windows **63**  
 Low beams **85**  
 Low beams, automatic, refer to High-beam assistant **87**  
 Lower back support **48**  
 Lug bolt lock **243**  
 Luggage compartment lid **38**  
 Luggage rack, refer to Roof-mounted luggage rack **149**  
 Lumbar support **48**

## M

Maintenance **237**  
 Maintenance requirements **237**  
 Maintenance, service requirements **82**  
 Maintenance system, BMW **237**



Malfunction displays, refer to  
Check Control [83](#)  
Manual air distribution [126](#)  
Manual air volume [127](#)  
Manual brake, refer to Parking  
brake [65](#)  
Manual mode, transmis-  
sion [72](#)  
Manual mode, transmission  
lock [73](#)  
Manual operation, backup  
camera [118](#)  
Manual operation, door  
lock [37](#)  
Manual operation, exterior mir-  
rors [57](#)  
Manual operation, fuel filler  
door [224](#)  
Manual operation, Park Dis-  
tance Control PDC [116](#)  
Manual operation, parking  
brake [66](#)  
Manual operation, Side  
View [120](#)  
Manual operation, trunk lid [38](#)  
Map, destination entry [158](#)  
Map in split screen [164](#)  
Map view [163](#)  
Marking on approved  
tires [230](#)  
Marking, run-flat tires [231](#)  
Massage seat, front [49](#)  
Massage seat, rear [51](#)  
Master key, refer to Remote  
control [32](#)  
Maximum cooling [127](#)  
Maximum speed, winter  
tires [230](#)  
Measure, units of [82](#)  
Medical kit [246](#)  
Memory for seat, mirrors,  
steering wheel [56](#)  
Menu in instrument clus-  
ter [77](#)  
Menus, operating, iDrive [19](#)  
Menus, refer to iDrive operat-  
ing concept [20](#)

Message list, traffic bulle-  
tins [164](#)  
Microfilter [128](#)  
Minimum tread, tires [229](#)  
Mirror [56](#)  
Mirror memory [56](#)  
Mobile communication devi-  
ces in the vehicle [147](#)  
Mobile phone [206](#)  
Modifications, technical, refer  
to Safety [6](#)  
Moisture in headlamp [240](#)  
Monitor, refer to Control Dis-  
play [19](#)  
Mounting of child restraint fix-  
ing systems [60](#)  
MP3 player [189](#)  
Multifunction steering wheel,  
buttons [12](#)  
Multimedia [179](#)  
Music collection [185](#)  
Music search [186](#)  
Music, storing [185](#)

## N

Navigation [154](#)  
Navigation data [166](#)  
Neck restraints, front, refer to  
Head restraints [53](#)  
Neck restraints, rear, refer to  
Head restraints [54](#)  
New wheels and tires [229](#)  
Night Vision with pedestrian  
detection [121](#)  
NORMAL program, Dynamic  
Driving Control [105](#)  
Notepad [26](#)  
Notes [6](#)  
Number of cylinders, en-  
gine [258](#)  
Nylon rope for tow-starting/  
towing [248](#)

## O

OBD Onboard Diagnos-  
tics [237](#)

Obstacle marking, backup  
camera [119](#)  
Odometer [75](#)  
Oil [235](#)  
Oil, adding [235](#)  
Oil additives [235](#)  
Oil change interval, service re-  
quirements [82](#)  
Oil filler neck [235](#)  
Oil level check [235](#)  
Oil types, alternative [235](#)  
Oil types, approved [235](#)  
Old batteries, disposal [244](#)  
Onboard computer, refer to  
Computer [78](#)  
Onboard Diagnostics  
OBD [237](#)  
Onboard monitor, refer to  
Control Display [19](#)  
Opening/closing from in-  
side [37](#)  
Opening/closing via door  
lock [37](#)  
Opening/closing with remote  
control [35](#)  
Operating concept, iDrive [19](#)  
Outside air, refer to Automatic  
recirculated-air control [127](#)  
Outside temperature warn-  
ing [75](#)  
Overheating of engine, refer to  
Coolant temperature [76](#)

## P

Paint, vehicle [251](#)  
Pairing, mobile phone [206](#)  
Panic mode [36](#)  
Park Distance Control  
PDC [115](#)  
Parked-car ventilation [131](#)  
Parked vehicle, condensa-  
tion [148](#)  
Parking aid, refer to PDC [115](#)  
Parking brake [65](#)  
Parking lamps [85](#)  
Parking lamps, bulb replace-  
ment [241](#)

Parking with Auto Hold [67](#)  
 Parts and accessories [7](#)  
 Passenger side mirror, tilting downward [57](#)  
 Pathway lines, backup camera [118](#)  
 PDC Park Distance Control [115](#)  
 Pedestrian detection, refer to Night Vision [121](#)  
 People detection, refer to Night Vision [121](#)  
 Permissible axle load [258](#)  
 Personal Profile [33](#)  
 Pinch protection system, glass sunroof [45](#)  
 Pinch protection system, windows [43](#)  
 Plastic, care [251](#)  
 Position, storing [156](#)  
 Postal code, entering in navigation [155](#)  
 Power failure [244](#)  
 Power output, engine [258](#)  
 Power sunroof, glass [45](#)  
 Power windows [43](#)  
 Pressure monitor, tires [92](#)  
 Pressure, tire air pressure [226](#)  
 Pressure warning, tires [95](#)  
 Profile, refer to Personal Profile [33](#)  
 Programmable memory buttons, iDrive [23](#)  
 Protective function, glass sunroof [45](#)  
 Protective function, windows [43](#)  
 Push-and-turn switch, refer to Controller [19](#)

## R

Radiator fluid [236](#)  
 Radio [172](#)  
 Radio-operated key, refer to Remote control [32](#)  
 Radio ready state [64](#)

Rain sensor [70](#)  
 Random [180](#)  
 Random playback [180](#)  
 RDS [173](#)  
 Rear automatic climate control [130](#)  
 Rear axle steering [102](#)  
 Rear cooler [136](#)  
 Rear entertainment [193](#), [198](#)  
 Rear fog lamp, bulb replacement [242](#)  
 Rear lamps [242](#)  
 Rear seats, adjusting [50](#)  
 Rear seats, basic position [51](#)  
 Rear sockets [136](#)  
 Rear storage compartment [141](#)  
 Rearview mirror [56](#)  
 Rear window defroster [128](#)  
 Recirculated-air mode [127](#)  
 Recommended tire brands [230](#)  
 Refueling [224](#)  
 Release tool [239](#)  
 Remaining range [77](#)  
 Remote control/key [32](#)  
 Remote control, malfunction [36](#)  
 Remote control, rear entertainment [194](#)  
 Remote control, universal [133](#)  
 Replacement fuse [244](#)  
 Replacing parts [239](#)  
 Replacing wheels/tires [229](#)  
 Reporting safety defects [8](#)  
 Reserve warning, refer to Range [77](#)  
 Resetting, Tire Pressure Monitor TPM [93](#)  
 Residual heat, automatic climate control [128](#)  
 Retaining straps, securing cargo [149](#)  
 Retreaded tires [230](#)  
 Road, avoiding [162](#)  
 Road detour [162](#)  
 Roadside Assistance [217](#)

Roadside parking lamps [86](#)  
 Roller sunblinds [44](#)  
 Roll stabilization, refer to Dynamic Drive [102](#)  
 Roof load capacity [258](#)  
 Roof-mounted luggage rack [149](#)  
 Rope for tow-starting/towing [248](#)  
 Route [162](#)  
 Route criteria, route [161](#)  
 Route, displaying [162](#)  
 Route section, bypassing [163](#)  
 RPM, engine [258](#)  
 RSC Runflat System Component, refer to Run-flat tires [231](#)  
 Rubber components, care [251](#)  
 Run-flat tires [231](#)  
 Run-flat tires, flat tire [93](#), [96](#)

## S

Safe braking [147](#)  
 Safety [6](#)  
 Safety belt reminder [53](#)  
 Safety belts [52](#)  
 Safety belts, care [252](#)  
 Safety switch, windows [44](#)  
 Safety systems, airbags [90](#)  
 Satellite radio [174](#)  
 Saving fuel [150](#)  
 Scale, changing during navigation [164](#)  
 Screen, refer to Control Display [19](#)  
 Screw driver [239](#)  
 Screw thread for tow fitting [248](#)  
 Search, BMW [218](#)  
 Seat belts, refer to Safety belts [52](#)  
 Seat heating, front [49](#)  
 Seat heating, rear [51](#)  
 Seating position for children [60](#)

Seat, mirror, and steering wheel memory [56](#)  
Seats [47](#)  
Seats, rear, adjusting [50](#)  
Seat ventilation, front [49](#)  
Seat ventilation, rear [52](#)  
Selection list in instrument cluster [77](#)  
Selector lever, automatic transmission [72](#)  
Sensors, care [252](#)  
Service and warranty [7](#)  
Service requirements, CBS Condition Based Service [237](#)  
Service requirements, display [82](#)  
Service, Roadside Assistance [246](#)  
Settings on Control Display [80](#)  
Settings, storing for seat, mirrors, steering wheel [56](#)  
Shifting, automatic transmission [71](#)  
Short commands [260](#)  
Shoulder support [48](#)  
Side airbags [90](#)  
Side View [120](#)  
Signaling, horn [12](#)  
Signals when unlocking [36](#)  
Sitting safely [47](#)  
Size [256](#)  
Ski bag [137](#)  
Slide/tilt glass roof [45](#)  
Smallest turning circle [257](#)  
Smoker's package [135](#)  
Snap-in adapter, mobile phone [212](#)  
Snow chains [231](#)  
Socket [135](#)  
Socket, OBD Onboard Diagnostics [237](#)  
Spare fuse [244](#)  
Special destinations, navigation [157](#)  
Specified oil types [235](#)  
Speed, average [78](#)

Speed limit, setting [79](#)  
Speedometer [14](#)  
Split screen [23](#)  
Split screen map settings [164](#)  
Spoken instructions, navigation [163](#)  
SPORT+ program, Dynamic Driving Control [104](#)  
SPORT program, Dynamic Driving Control [104](#)  
Sport program, transmission [72](#)  
Stability control systems [100](#)  
Start/Stop button [64](#)  
Start function during malfunction [33](#)  
Starting assistance [246](#)  
Starting the engine [64](#)  
State/province, selecting for navigation [154](#)  
Stations, stored [178](#)  
Station, storing [172](#)  
Status display, tires [93](#)  
Status information, iDrive [22](#)  
Status of Owner's Manual [6](#)  
Steering, Integral Active Steering [102](#)  
Steering wheel, adjusting [58](#)  
Steering wheel heating [58](#)  
Steering wheel memory [56](#)  
Steptronic, automatic transmission [71](#)  
Stopping the engine [65](#)  
Storage compartment between seats [141](#)  
Storage compartment on the center console [141](#)  
Storage compartments [139](#)  
Storage compartments, locations [139](#)  
Storage, tires [231](#)  
Storing the vehicle [252](#)  
Street, entering for navigation [155](#)  
Summer tires, tread [229](#)  
Suspension settings [103](#)

Switch for Dynamic Driving Control [103](#)  
Switch-on times, parked-car ventilation [132](#)  
Switch, refer to Cockpit [12](#)  
Symbols [6](#)

## T

Tachometer [76](#)  
Tail and brake lamps [242](#)  
Tailgate [38](#)  
Tailgate, automatic [39](#)  
Tailgate via remote control [36](#)  
Tail lamps [242](#)  
Tail lamps, bulb replacement [242](#)  
Technical changes, refer to Safety [6](#)  
Technical data [256](#)  
Telephone [206](#)  
TeleService [217](#)  
Temperature, automatic climate control [127](#)  
Temperature display, external temperature [75](#)  
Temperature, engine oil [76](#)  
Terminal 0 [64](#)  
Terminal 15 [64](#)  
Terminal R [64](#)  
Terminal, starting aid [246](#)  
Theft alarm system, refer to Alarm system [41](#)  
Theft protection, lug bolts [243](#)  
Theft protection, refer to Central locking system [35](#)  
Thermal camera, refer to Night Vision [121](#)  
Thigh support [47](#)  
Third brake lamp [242](#)  
Tilt alarm sensor [42](#)  
Tilt, seats [47](#)  
Time of arrival [79](#)  
Tire age [229](#)  
Tire damage [229](#)  
Tire identification marks [227](#)  
Tire inflation pressure [226](#)

Tire inflation pressure monitor, refer to FTM 95  
 Tire Pressure Monitor TPM 92  
 Tires, changing 229  
 Tires, everything on wheels and tires 226  
 Tires, flat tire 243  
 Tires, run-flat tires 231  
 Tire tread 229  
 Toll roads, route 162  
 Tone 170  
 Tool kit 239  
 Tools 239  
 Torque, engine 258  
 Total vehicle weight 258  
 Tow fitting 247  
 Towing 247  
 Town/city, navigation 154  
 Tow-starting 247  
 Tow truck 249  
 TPM Tire Pressure Monitor 92  
 Traction control 100  
 TRACTION program, Dynamic Driving Control 104  
 Traffic bulletin map 165  
 Traffic bulletins, navigation 164  
 Traffic obstruction, bypassing 166  
 Transmission, automatic 71  
 Transmission lock, releasing 73  
 Transporting children safely 60  
 Tread, tires 229  
 Treble 170  
 Trip computer 80  
 Triple turn signal activation 69  
 Trip odometer 75  
 Truck for tow-starting/towing 249  
 Trunk lid 38  
 Trunk lid, automatic 39  
 Trunk lid, emergency unlocking 40

Trunk lid, hotel function 40  
 Trunk lid, manual operation 38  
 Trunk lid via remote control 36  
 Trunk, storage compartments 142  
 Turning circle 257  
 Turning circle lines, backup camera 119  
 Turn signals, front, bulb replacement 240  
 Turn signals, operation 69  
 Turn signals, rear, bulb replacement 242

## U

Unintentional alarm 42  
 Units of measure 82  
 Universal remote control 133  
 Unlock button, automatic transmission 72  
 Unlocking/locking from inside 37  
 Unlocking/locking via door lock 37  
 Unlocking/locking with remote control 35  
 Upholstery care 251  
 USB audio interface 190  
 USB interface 139

## V

Vanity mirror 58  
 Variable Damping Control, refer to Dynamic Damping Control 102  
 Variable steering, Integral Active Steering 102  
 Vehicle battery 244  
 Vehicle, breaking in 146  
 Vehicle care 251  
 Vehicle identification number, refer to Identification number in the engine compartment 233

Vehicle jack 243  
 Vehicle paint 251  
 Vehicle storage 252  
 Vehicle wash 250  
 Ventilation 129  
 Ventilation, refer to Parked-car ventilation 131  
 Version of navigation data 167  
 Video playback 181  
 Voice activation, short commands 260  
 Voice activation system 25  
 Volume, setting 170

## W

Warning lamps 14  
 Warning messages, refer to Check Control 83  
 Warning triangle 246  
 Washer fluid 71  
 Washer fluid reservoir, capacity 259  
 Washer nozzles, windshield 70  
 Washer system 69  
 Washing, vehicle 250  
 Water on roads 147  
 Weather Band 174  
 Weights 258  
 Welcome lamps 85  
 Wheel base, vehicle 257  
 Wheel change 243  
 Wheels, changing 229  
 Wheels, everything on wheels and tires 226  
 Wheels, Flat Tire Monitor FTM 95  
 Wheels, Tire Pressure Monitor TPM 92  
 Width with mirrors, vehicle 256  
 Width without mirrors, vehicle 257  
 Window defroster, rear 128  
 Windows, powered 43

Windshield, climate control [147](#)  
Windshield washer fluid [71](#)  
Windshield washer nozzles [70](#)  
Windshield washer system [69](#)  
Windshield wiper [69](#)  
Windshield wipers, fold-out position [71](#)  
Winter storage, care [252](#)  
Winter tires, suitable tires [230](#)  
Winter tires, tread [229](#)  
Wiper blades, replacing [239](#)  
Wiper fluid [71](#)  
Wiper system [69](#)  
Wood, care [251](#)  
Wordmatch concept, navigation [24](#)  
Wrench [239](#)

## X

xDrive [101](#)  
Xenon headlamps, bulb replacement [240](#)

## Y

Your individual vehicle [6](#)



More about BMW



[bmwusa.com](http://bmwusa.com)

**The Ultimate Driving  
Machine**

01 41 2 602 638 ue



Online Edition for Part no. 01 41 2 602 638 - © 09 09 510 BMW AG

