

Supplementary
Owner's Manual
for BMW
ActiveHybrid X6



The Ultimate
Driving Machine



ActiveHybrid X6 **Supplementary Owner's Manual of the vehicle**

We are happy that you have decided on a BMW ActiveHybrid X6. The more familiar you are with your BMW, the greater command you will have of it in traffic.

We therefore ask you to:

Read the information contained in this Supplementary Owner's Manual before you start off in your new BMW. It contains important notes on vehicle operation that will allow you to make full use of the technical advantages of your BMW.

We wish you a pleasant and safe driving experience

BMW Group

© 2009 Bayerische Motoren Werke
Aktiengesellschaft
Munich, Germany
Reprinting, including excerpts,
only with the written consent of
BMW AG, Munich.
US English IX/09, 09 09 500
Printed on environmentally friendly paper,
bleached without chlorine, suitable for recycling.

Contents

The fastest way to find specific topics is to use the index, refer to page 48.

Using this Owner's Manual

4 Notes

At a glance

8 Cockpit

Controls

12 Driving

21 Everything under control

23 Climate

Driving tips

26 Things to remember when driving

Mobility

32 Refueling

34 Wheels and tires

35 Engine compartment

36 Replacing components

37 Giving and receiving assistance

Reference

44 Technical data

48 Everything from A to Z

Notes

BMW ActiveHybrid X6

Your BMW ActiveHybrid X6 has two different types of drive: A combustion engine and electric motors. This combination enables a particularly efficient energy management. Additional advantages include special performance specifications such as an optimized acceleration through assistance to the combustion engine provided by the two electric motors.

About this Owner's Manual

This Supplementary Owner's Manual contains all essential equipment, instructions, and technical data in which the BMW ActiveHybrid X6 M differs from the BMW X6. For a description of equipment not contained in this Supplementary Owner's Manual, please refer to the BMW X6 Owner's Manual or possibly to other brochures included with the onboard literature.

We have made every effort to ensure that you are able to find what you need in this Owner's Manual as quickly as possible. The fastest way to find specific topics is to refer to the detailed index at the back of the manual. If you wish to gain an initial overview of your vehicle, you will find this in the first chapter.

Should you sell your BMW some day, please remember to also pass the Owner's Manual on to the new owner; it is an important component of your vehicle.

Additional sources of information

If you have additional questions, your BMW Sports Activity Vehicle Center is always happy to advise you.

You can find information on BMW, e.g. on technology, on the Internet at www.bmwusa.com.

Symbols used



Indicates precautions that must be followed precisely in order to avoid the possibility of personal injury and serious damage to the vehicle. ◀



Indicates information that will assist you in gaining the optimum benefit from your vehicle and enable you to care more effectively for your vehicle. ◀



Refers to measures that can be taken to help protect the environment. ◀

◀ Marks the end of a specific item of information.

* Indicates special equipment, country-specific equipment and optional accessories, as well as equipment and functions not yet available at the time of printing.

"..." Identifies Control Display texts used to select individual functions.

›...‹ Verbal instructions to use with the voice activation system.

Symbols on vehicle components



Indicates that you should consult the relevant section of this Owner's Manual for information on a particular part or assembly.



Indicates vehicle parts that are high-voltage components of the hybrid system.

Improper work on these vehicle parts can lead to life-threatening injuries.

The individual vehicle

When purchasing your BMW, you have decided in favor of a model with individualized equipment and features. This Owner's Manual describes the entire array of options and equipment available with a specific BMW model.

Please bear in mind that the manual may contain information on accessories and equipment that you have not specified for your own vehicle. Sections describing options and special equipment are marked by asterisks * to assist you in identifying possible differences between the descriptions in this manual and your own vehicle's equipment.

If equipment in your BMW is not described in this Owner's Manual, please refer to the BMW X6 Owner's Manual.

Editorial notice

BMW pursues a policy of continuous, ongoing development that is conceived to ensure that our vehicles continue to embody the highest quality and safety standards combined with advanced, state-of-the-art technology. For this reason, it is possible that the features described in this Owner's Manual could differ from those on your vehicle.

For your own safety

The BMW ActiveHybrid X6 has special features, e.g. electric driving, that can require special alertness in traffic.



During electric driving, please note that pedestrians and other road users may fail to notice the vehicle in the usual way due to the lack of engine noise. For example, proceed with particular caution when pulling into and out of a parking space. ◀

Maintenance and repairs



Advanced technology, e.g. the use of modern materials and high-performance electronics, requires specially adapted maintenance

and repair methods. Therefore, have corresponding work on your BMW performed only by your BMW Sports Activity Vehicle Center or a repair shop that works according to BMW repair procedures with correspondingly trained personnel. If this work is not carried out properly, there is a danger of subsequent damage and related safety hazards. Particularly when work is performed on the high-voltage systems, lack of expertise can lead to life-threatening injuries. ◀

Teleservice Report*

Transmits technical data about your vehicle as needed to BMW at regular intervals; these data are used in the development of BMW products. The service is only used in vehicles with particular technical equipment. A Teleservice Report is only activated in connection with the BMW SIM card-equipped phone unit installed in the vehicle and does not cost you anything. Neither personal data nor location data are transmitted.





At a glance

This overview of buttons, switches and displays is intended to familiarize you with your vehicle's operating environment. The section will also assist you in becoming acquainted with the control concepts and options available for operating the various systems.

Cockpit

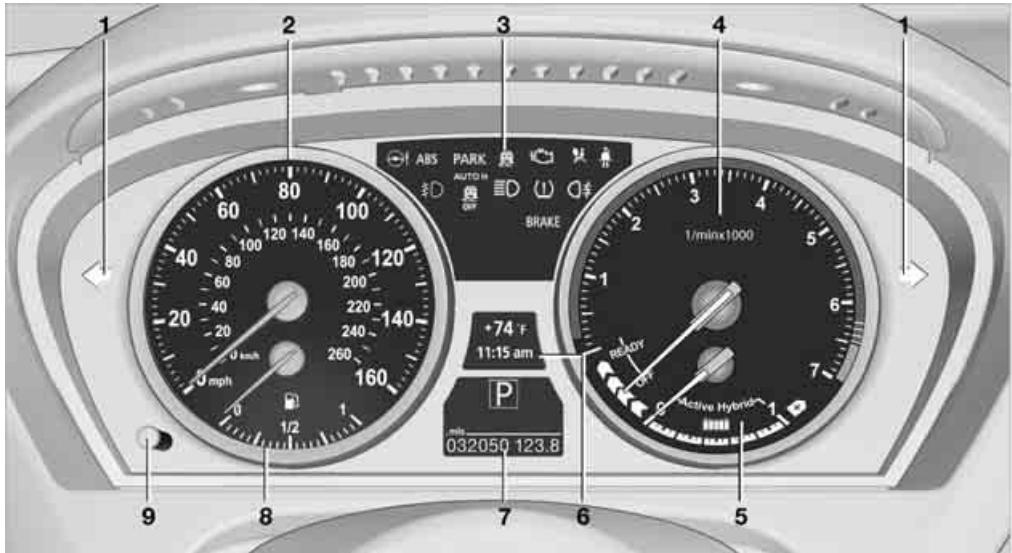
Instrument panel



 For the description of components without page references, please refer to the respective keyword in the Owner's Manual of the BMW X6. ◀

1 Indicator lamps for turn signals

2 Speedometer

3 Indicator and warning lamps

4 Tachometer

5 Display for

- ▷ Charge state [21](#)
- ▷ Activating/deactivating drive readiness [14](#)
- ▷ Electric driving: eDRIVE [15](#)
- ▷ Assisted combustion engine: eBOOST [16](#)
- ▷ Energy recovery/regeneration: CHARGE [16](#)

6 Display for

- ▷ Clock/date
- ▷ Outside temperature
- ▷ Indicator/warning lamps
- ▷ Speed of cruise control [19](#)

7 Display for

- ▷ Odometer and trip odometer
- ▷ Computer
- ▷ Date and remaining travel distance for service requirements
- ▷ Transmission positions [16](#)
- ▷ HDC Hill Descent Control
- ▷ High-beam assistant*
- ▷  There is a Check Control message

8 Fuel gauge [22](#)

9 Resetting trip odometer Displaying service requirement





Controls

This chapter is intended to provide you with information for complete control of your vehicle. Its extensive array of features and accessories, both for driving and for your own safety, comfort and convenience, are described here.

Driving

BMW ActiveHybrid X6

The concept

Through the interplay of the combustion engine and electric motors, your BMW ActiveHybrid X6

achieves a particularly efficient fuel consumption and optimizes vehicle performance.

Components of the system

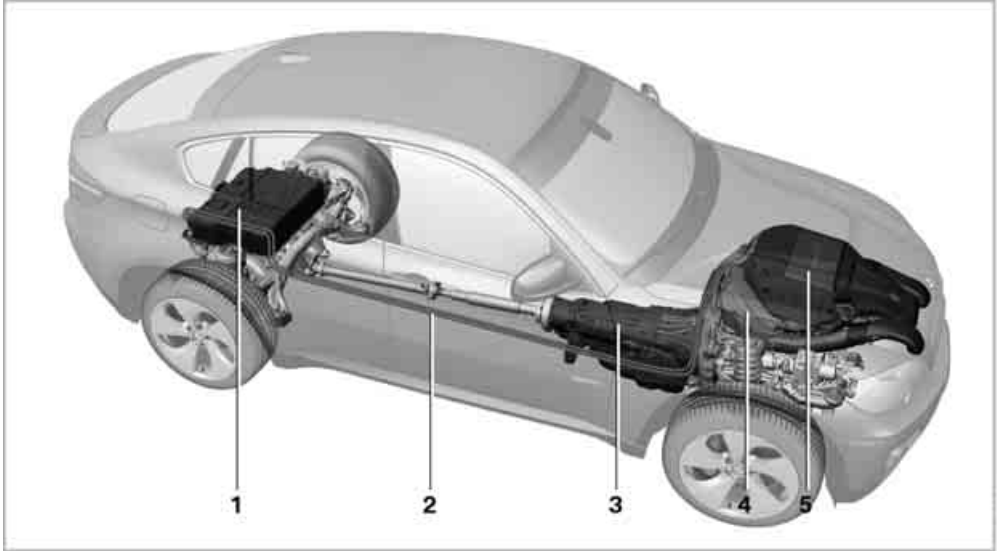

- 1 High-voltage battery
- 2 High-voltage wires: orange
- 3 Two-Mode Active Transmission with 2 integrated electric motors
- 4 Combustion engine
- 5 Control-system electronics

⚠ Do not damage orange high-voltage wires. Otherwise, there is the risk of fatal injury by electrocution. ◀

The energy required to drive the electric motors is stored in the high-voltage battery stored under the luggage compartment floor in the luggage compartment.

To produce electrical energy, the two electric motors in the Two-Mode Active Transmission function as generators. They are driven by the combustion engine or by kinetic energy during braking.

This permits an energy conversion of kinetic energy into electrical current.

Functions of the hybrid system

The hybrid system of your BMW ActiveHybrid X6 offers the following functions.

Electric driving: eDRIVE

Under certain conditions, refer to page 15, the vehicle is powered exclusively by its electric motors.

Driving with combustion engine: DRIVE

The combustion engine supplies the drive output for moving the vehicle. The high-voltage battery is charged at the same time.

The hybrid system always starts the combustion engine automatically, refer to page 16.

Assisted combustion engine: eBOOST

The combustion engine supplies the main drive output for moving the vehicle.

In this mode, the electric motors assist the combustion engine with additional power as needed.

Energy recovery: CHARGE

When reducing vehicle speed, the kinetic energy can be converted into electrical energy, refer to page 16.

Start/Stop button, ready modes



The following readiness modes can be achieved by pressing the Start/Stop button:

- ▷ Radio readiness on/off
- ▷ Ignition on/off

- ▷ Drive readiness activate/deactivate

 In order to switch on drive readiness mode, also step on the brake. ◀

Radio readiness on/off

Some electrical equipment is operational. The time and outside temperature are displayed in the instrument panel.

Radio readiness is switched on:

- ▷ when the remote control is inserted into the ignition lock
- ▷ with comfort access*, when the Start/Stop button is pressed without stepping on the brake.

Radio readiness is automatically switched off:

- ▷ when the remote control is removed from the ignition lock
- ▷ with comfort access*, by touching the surface above the door lock, refer to BMW X6 Owner's Manual.

Ignition on/off

When the ignition is switched on, all electrical equipment is operational. The odometer and trip meter are displayed in the instrument panel.

When the ignition is switched off, all indicator lamps and warning lamps go out again.

The ignition is automatically switched off:

- ▷ when the remote control is removed from the ignition lock
- ▷ with comfort access*, by touching the surface above the door lock, refer to BMW X6 Owner's Manual.

Pressing the start/stop button again switches the ignition back on.

For example, the ignition is not switched off in the following situations:

- ▷ the brakes are actuated
- ▷ the low beams are switched on

 If you do not plan to start driving, switch off the ignition and unneeded electrical equipment in order to reduce the drain on the battery. ◀

Drive readiness

With drive readiness activated, the vehicle is ready to drive.

Switching on drive readiness corresponds to starting the engine in conventional vehicles.

Drive readiness can take the following forms:

- ▷ Electric driving
The combustion engine is not switched on.
- ▷ Driving with combustion engine
The vehicle is driven by the combustion engine.

Drive readiness in detail

 Never leave the vehicle unattended with drive readiness activated; such a vehicle represents a potential safety hazard. ◀

Activating drive readiness

1. Close the driver's door.
2. Insert the remote control as far as possible into the ignition lock. With comfort access*, place the remote control into the vehicle, refer to BMW X6 Owner's Manual.
3. Depress brake pedal.

 To initialize the brake system, the brake pedal travel is longer than usual during activation of drive readiness. After the brake pedal is released, the pedal travel returns to normal. ◀

4. Press the Start/Stop button.



5. Drive readiness is active:
 - ▷ Starting the combustion engine
 - ▷ or electric drive readiness, silent start:
The tachometer pointer moves into the READY position.
-  Electric drive readiness can be activated within an interval of approx. 2 to 60 seconds after radio readiness is switched on, provided that the function conditions for electric driving have been met, refer to page 15. ◀

Electric drive readiness, silent start

The vehicle is ready to drive without starting the combustion engine.

Silent start, the noiseless starting of the vehicle, can be activated within an interval of approx. 2 to 60 seconds after radio readiness is switched on, under the following conditions:

- ▷ driver's door closed
- ▷ conditions met to allow electric driving, refer to page 15

 During electric driving, please note that pedestrians and other road users may fail to notice the vehicle in the usual way due to the lack of engine noise. For example, proceed with particular caution when pulling into and out of a parking space. ◀

Starting the combustion engine

When drive readiness is switched on under the following circumstances, the combustion engine is started:

- ▷ drive system not at operating temperature
- ▷ high temperature of hybrid system
- ▷ insufficient charge state of high-voltage battery or fully charged high-voltage battery

 If a Silent start is not possible:
Avoid frequent starting of the combustion engine in quick succession or repeated starting attempts in which the engine does not start. Otherwise, the fuel is not burned or inadequately burned and there is a danger of overheating and damaging the catalytic converter. ◀

 Do not run the combustion engine in enclosed spaces; otherwise, the inhalation of toxic exhaust gases can cause loss of consciousness and death. The exhaust gases contain carbon monoxide, an odorless and colorless, but highly toxic gas.

Never leave the vehicle unattended with the combustion engine running; such a vehicle represents a potential safety hazard. ◀

Deactivating drive readiness

When drive readiness is switched off, the tachometer pointer is in the OFF position.

 When leaving the vehicle, always take along the remote control.

Set the parking brake firmly when parking; otherwise, the vehicle could roll. ◀

After the vehicle is switched off, audible operating sounds may issue from the hybrid system, e.g. the cooling of the high-voltage battery.

Procedure

1. Select transmission position P with the vehicle stationary.
2. Press the Start/Stop button.
3. Set the parking brake.
4. Remove the remote control from the ignition lock.
Before removing the remote control, first press it in as far as possible to release the locking device.

Before driving into a car wash

The vehicle can roll if you proceed according to the following steps:

1. With comfort access*: insert the remote control into the ignition lock.
2. Depress brake pedal.
3. Select transmission position N.
4. Release the parking brake or deactivate Automatic Hold.
5. Press the Start/Stop button to deactivate drive readiness.

Transmission position P will be selected:

- ▷ automatically after approx. 30 minutes

- ▷ if you remove the remote control from the ignition lock

Starting to drive

1. Activate drive readiness.
2. Select transmission position D, M/S, or R.
3. Release the parking brake.
4. Start to drive.

Driving

Electric driving: eDRIVE

Requirements

Electric driving is possible under the following conditions:

- ▷ driving speed:
a maximum of approx. 37 mph/60 km/h
- ▷ charge state display of the high-voltage battery: at least 15 %
- ▷ transmission in position D or R, refer to page 17
- ▷ drive system at operating temperature
- ▷ accelerator pedal not pressed down too far
- ▷ driver's door closed

Possible driving speed

The possible speed that can be reached in electric driving depends on the charge state of the high-voltage battery.

- ▷ charge state display 15 % to 40 %:
maximum driving speed is approx. 25 mph/40 km/h
- ▷ charge state display 40 % to 100 %:
maximum driving speed is approx. 40 mph/65 km/h

When accelerating past a speed of 25 mph/40 km/h, the combustion engine is started briefly in order to assure smooth acceleration.

Indicators of electric driving in the instrument panel, refer to page 22.

Possible range

The vehicle can travel approx. 1.5 miles/2.5 km under electric power.

Driving with combustion engine: DRIVE

The combustion engine supplies the drive output for moving the vehicle. The high-voltage battery is charged at the same time.

Automatic starting while driving

Under the following circumstances, the combustion engine is started automatically while driving:

- ▷ transmission position M/S selected
- ▷ driving speed greater than 40 mph/65 km/h
- ▷ low charge state or fully charged high-voltage battery, e.g. when driving downhill
- ▷ to protect the high-voltage system from overheating, e.g. when driving downhill
- ▷ high output request, e.g. by accelerator pedal position.

Automatic switching off while driving

When decelerating under the conditions for electric driving, refer to page 15, the combustion engine is switched off.

Assisted combustion engine

The combustion engine supplies the main drive output for moving the vehicle.

The electric motors assist by providing additional drive output as needed.

eBOOST

When accelerating quickly, e.g. when passing another vehicle, power from the two electric motors simultaneously is requested in addition to that of the combustion engine. To trigger this, step down hard on the accelerator pedal. Display in the instrument panel, refer to page 22.

Energy recovery: CHARGE

The hybrid system makes it possible to convert kinetic energy into electrical current, e.g. during

braking. This energy recovery is used to charge the high-voltage battery. The battery supplies this stored energy back to the electric motors as needed.

To recover the braking energy, the following conditions must be met:

- ▷ The vehicle is in motion.
- ▷ The selector lever is in the position D, R, or M/S.
- ▷ The high-voltage battery is not completely charged.

Display of energy recovery in the instrument panel, refer to page 22

Two-Mode Active Transmission with Steptronic

The Das Two-Mode Active Transmission is an automatic transmission in which the gears can be shifted in a fully automatic fashion or can be shifted manually on demand. The manual shifting is performed using the selector lever or the shifting paddles of the Steptronic, refer to page 18.

- ▷ Automatic shifting may be perceptible when decelerating at a low speed. ◀

Transmission positions

P R N D M/S + -

- ⚠ Hold the brake pedal down until starting to drive; otherwise, the vehicle can begin to roll. ◀

Displays in instrument panel



P R N D, S1 through S7, M1 through M7

The transmission position and the currently engaged gear are displayed.

Selecting transmission position

- ▶ You can select transmission positions D, R or N only when drive readiness is activated.
- ▶ With the vehicle stationary, depress the brake pedal before shifting out of P or N; otherwise the shift command will not be executed: shiftlock.

 Hold the brake pedal down until starting to drive; otherwise, the vehicle can begin to move. ◀

Shifting into D, R, N

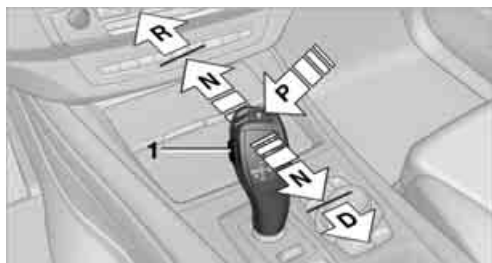

Briefly press the selector lever in the desired direction, beyond a resistance point if necessary. When shifting out of P or into R, simultaneously push the unlock button 1.

The engaged transmission position is displayed on the selector lever.

The selector lever immediately returns to the center position when released.

Shifting into P

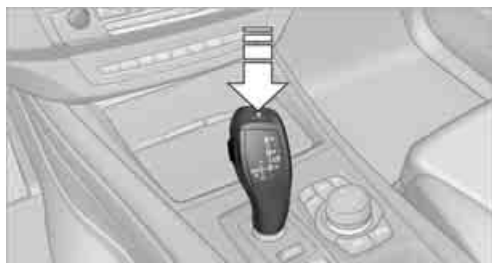

Press button **P**.

 When the vehicle is stationary and the transmission is in the R, D, or M/S position, if you disconnect the driver's seat safety belt and open the driver's door without stepping on any of the pedals, then the transmission shifts into position P. ◀

R Reverse

Select only with the vehicle stationary.

An interlock prevents inadvertent gearshifts into transmission position R. To release the lock, push the unlock button 1.

 During electric driving, please note that pedestrians and other road users may fail to notice the vehicle in the usual way due to the lack of engine noise. For example, proceed with particular caution when pulling into and out of a parking space. ◀

P Park

Select only with the vehicle stationary. The rear wheels are locked.

 The transmission automatically shifts into P as soon as you switch off the engine. Unless position N is selected and the remote control is in the ignition lock. ◀

N Neutral

Can be selected in automatic car washes, for example. The vehicle can roll.

 The transmission remains in N even after the engine is switched off whenever you leave the remote control in the ignition lock. This function is used, for example, in a car wash, refer to page 15. After approx. 30 minutes P is automatically engaged. ◀

Shifting into N

It is possible to select N even when the ignition is switched on.

It is thus possible to move the vehicle, e.g. in the event of a malfunction, even if it is not possible to activate drive readiness.

D Drive, automatic position

Position for normal vehicle operation. All forward gears are shifted automatically. Depending on operating conditions, the vehicle is driven electrically or with the combustion engine.

The fuel consumption is the lowest in transmission position D.

Kick-down

The kick-down mode provides maximum acceleration.

Press the accelerator pedal beyond the increased resistance at full throttle.

Due to the high power requested, the combustion engine is started and is assisted by the electric motors as needed.

Sport program and manual mode M/S



Press selector lever out of transmission position D toward the left:

The sport program is activated, S and the engaged gear are displayed in the instrument panel. This position is recommended for a performance-oriented driving style.

With the sport program activated, the combustion engine is always started.

When the selector lever is pressed forward or back, the manual mode is activated and the Steptronic shifts the gear. For example, M3 is displayed in the instrument panel.

Upshifts and downshifts are executed only when they will result in a plausible combination of engine and vehicle speed; thus, for example, a downshift that would cause the engine to overrev will not be executed by the system. The

selected gear is briefly displayed in the instrument panel, followed by the current gear.

To use the automatic function again, press the selector lever to the right into position D.

Changing gears using shifting paddles on steering wheel

The shifting paddles make it possible to quickly change gears since both hands can remain on the steering wheel.



- ▷ Upshifting: pull on one of the shifting paddles, arrows +.
- ▷ Downshifting: press on one of the shifting paddles, arrows -.

The gear change using the shifting paddles can be executed in automatic mode D or in manual mode M/S.

When the shifting paddles are actuated during electric driving, the combustion engine starts.

Changing gears in manual mode M/S

With manual mode activated, gear changes are executed using the shifting paddles or the selector lever.

With the transmission position M/S selected, the manual mode remains active.

Changing gears in automatic mode D

Even in automatic mode D, gear shifts can be executed using the shifting paddles.

The combustion engine starts.

Then if a certain amount of time passes without a gear change being executed using the shifting paddles or a corresponding acceleration, then the transmission returns to automatic shifting of the forward gears.

Cruise control

The concept

The cruise control is available for use at speeds of approx. 20 mph/30 km/h. The vehicle stores and maintains the speed that you set using the lever mounted on the steering column.

 The cruise control can also be activated during electric driving, eDRIVE. The cruise control provides a particularly sensitive adjustment of the electric drive output. ◀

 Do not use the cruise control under driving conditions that do not permit a constant speed, e.g. when driving on winding roads, in heavy traffic or in poor road conditions such as snow, rain, ice, and loose road surface. Otherwise you could lose control of the vehicle and cause an accident. ◀

One lever for all functions

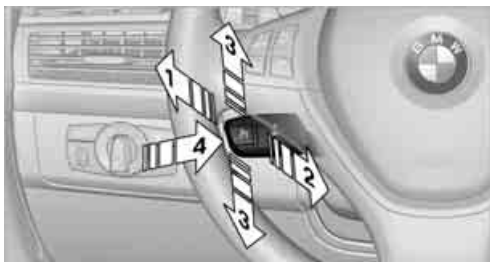

- 1 Storing speed and maintaining or increasing
- 2 Storing speed and maintaining or decreasing
- 3 Deactivating cruise control
- 4 Resuming stored speed

Maintaining current speed

Briefly press, arrow **1**, or briefly pull, arrow **2** lever.

The speed currently being driven is stored and maintained. It is indicated on the speedometer and briefly in the instrument panel.

If the engine braking effect is not sufficient on steep downhill slopes, the vehicle may exceed the set speed.

Increasing speed

Repeatedly press the lever up to or beyond the resistance point, arrow **1**, until the desired speed is set.

- ▷ Each time the lever is pressed to the resistance point, the speed is increased by approx. 1 mph or 1 km/h.
- ▷ Each time the lever is pressed beyond the resistance point, the desired speed increases by a maximum of 5 mph or 10 km/h.

The system stores the setting and maintains the set speed.

Accelerating with lever

Accelerate slightly:

Press the lever up to the resistance point, arrow **1**, until the desired speed is reached.

Accelerate more rapidly:

Press the lever beyond the resistance point, arrow **1**, until the desired speed is reached.

The vehicle accelerates without pressure on the accelerator pedal. The system stores the setting and maintains the set speed.

Reducing speed

Repeatedly pull the lever up to the resistance point or beyond, arrow **2**, until the desired speed is displayed.

- ▷ Each time the lever is pulled up to the resistance point, the desired speed decreases by approx. 1 mph or 1 km/h.
- ▷ Each time the lever is pulled beyond the resistance point, the desired speed is decreased by a maximum of 5 mph or 10 km/h until the minimum speed of 20 mph or 30 km/h is reached.

The system stores the setting and maintains the set speed.

Deactivating cruise control

Briefly press the lever up or down, arrow **3**. The displays in the speedometer go out.

In addition, the system is automatically deactivated:

- ▷ when braking
- ▷ when transmission position N is engaged
- ▷ when DTC is activated or DSC is deactivated
- ▷ when HDC is activated
- ▷ when the parking brake is set
- ▷ when driving stability control systems intervene

Accelerating does not deactivate the cruise control. After releasing the accelerator pedal, the stored speed is reached and maintained again.

Warning lamp



The warning lamp lights up if the cruise control has been deactivated automatically, e.g. by a control intervention of the DSC. A message appears on the Control Display.

Resuming stored speed

Briefly press the button, arrow **4**. The stored speed is resumed and maintained.

With the ignition switched off, the stored speed value is deleted and cannot be resumed again.

Displays in instrument panel



- 1 Stored desired speed
- 2 Selected desired speed appears briefly

If --- mph or --- km/h temporarily appears in the instrument panel display, it is possible that the system prerequisites for operation are currently not met.

Malfunction



The warning lamp lights up if the system has failed. A message appears on the Control Display.

Everything under control

Charge state display

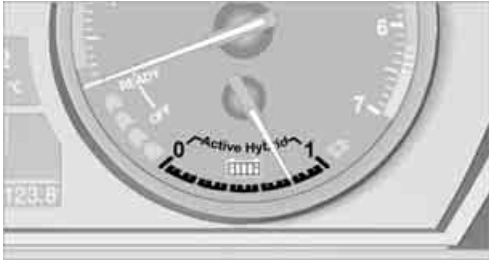

Shows the available charge on a scale from 0 to 1 when drive readiness is switched on. At the scale value 1, the high-voltage battery is fully charged. The five segments divide the scale into ranges of 20 % each.

In normal driving operation, the high-voltage battery is charged to approx. 80 %. This permits the hybrid system to make optimal use of the energy recovery when decelerating or driving downhill.

Even at the scale value 0, the hybrid system is still under high voltage.

Displaying operating modes

Energy flows

In all operating modes of the vehicle, the energy flows can be displayed on the Control Display. This gives you an overview of the functioning of the hybrid system in different driving conditions.

Accessing the energy flow display

1. "Vehicle Info"
2. "Hybrid"



3. Energy flows are displayed.

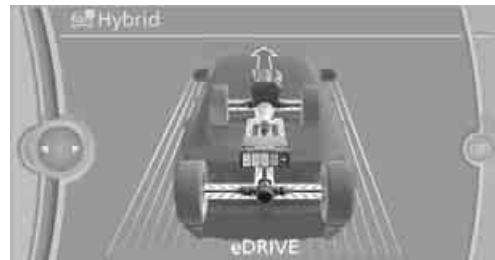

The energy flow display functions according to the following principle:

- ▷ Blue: Electrical energy.
- ▷ Red: Energy from the combustion engine.
- ▷ Arrow: Direction of the energy flow.
- ▷ Segments of the high-voltage battery symbolize the charge state.
- ▷ The operating modes are displayed: DRIVE, eDRIVE, CHARGE, eBOOST

Operating by voice activation*

You can also select the "Hybrid" menu using voice activation.

- ▷Hybrid◀.
The menu is selected.

Electric driving: eDRIVE



During electric driving, the power output by the electric motors is indicated by arrows: Depending on the position of the accelerator pedal, up to four arrows light up one after another.

The tachometer pointer is in the READY position.

If all four arrows have already lit up, when additional drive power is needed, e.g. for acceleration, the combustion engine is switched on.

Assisted combustion engine: eBOOST



At the maximum output from the electric motors, all four arrows light up simultaneously.

Energy recovery: CHARGE

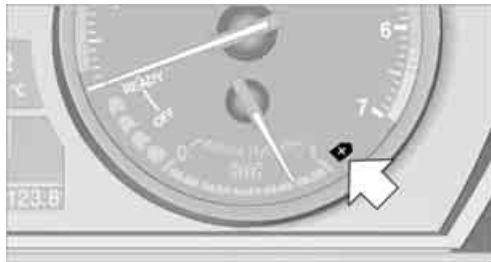

The energy recovery is indicated in the tachometer as an arrow with the + symbol: The high-voltage battery is charged.

Fuel gauge



Fuel tank capacity: approx. 22.5 US gal/ 85 liters. You will find information on refueling on page 32.

If the tilt of the vehicle varies for a longer period, when you are driving in mountainous areas, for example, the indicator may fluctuate slightly.

Reserve

After the reserve quantity has been reached, a message briefly appears on the Control Display; the remaining range is shown in the computer. Below a range of approx. 30 miles/50 km, the message remains on the Control Display.

 Refuel as soon as possible once your cruising range falls below 30 miles/ 50 km, otherwise engine functions are not ensured and damage can occur. ◀

Climate

Air-conditioning functions, refer to BMW X6 Owner's Manual.

Special features of the automatic air-conditioning system

The automatic air-conditioning system of your BMW with an electric air-conditioning compressor is independent of the combustion engine.

It is thus possible to have a comfortable climate in the vehicle interior even when the combustion engine is switched off.

Automatic air-conditioning system with drive readiness

The automatic air-conditioning system can be used as usual whenever drive readiness is switched on, for example during electric driving.

If there is no longer a sufficient charge in the high-voltage battery, then the combustion engine is switched on.

Cooling function while stationary



The cooling function can be activated while stationary if the ignition is switched on.

1. Switch on the ignition.
2. Press the button.

The cooling function is switched on.

If there is no longer a sufficient charge in the high-voltage battery, then the cooling function is switched off.

More information can be found in the BMW X6 Owner's Manual.

Cooling of the high-voltage system

The automatic air-conditioning system is also used to cool the high-voltage system.

Therefore the air-conditioning compressor can automatically switch on, even when the cooling function of the automatic air-conditioning system is switched off.

After the vehicle is switched off, audible operating sounds may issue from the hybrid system, e.g. the cooling of the high-voltage battery.



Driving tips

This section is designed to provide you with extra support by supplying information useful in dealing with specific driving and operating conditions.

Things to remember when driving

Break-in period

Moving parts need breaking-in time to adjust to each other. To ensure that your vehicle continues to provide optimized economy of operation throughout an extended service life, we request that you devote careful attention to the following section.

Engine and rear axle differential

Always obey all official speed limits.

Up to 1,200 miles/2,000 km

Drive at various engine and vehicle speeds, but do not exceed:

- ▷ 4,500 rpm or 100 mph/160 km/h

Avoid full-throttle operation and use of the transmission's kick-down mode during these initial miles.

From 1,200 miles/2,000 km

The engine and vehicle speed can gradually be increased.

Brake system

Brakes require an initial break-in period of approx. 300 miles/500 km to achieve optimized contact and wear patterns between brake pads and rotors. Drive in a reserved manner during this break-in period.

Following part replacement

Observe the break-in instructions again if components mentioned above must be replaced after subsequent driving operation.

Saving fuel

The fuel consumption of your vehicle depends on various factors. Through a few simple steps, your driving style, and regular maintenance, you can have a positive influence on your fuel consumption and environmental impact.

Removing unnecessary cargo

Additional weight increases fuel consumption.

Removing add-on parts after use

Remove unneeded auxiliary mirrors, roof or rear luggage racks after use. Add-on parts attached to the vehicle impede the aerodynamics and increase the fuel consumption.

Closing windows and glass sunroof*

An open glass sunroof or window likewise increases air resistance and thus fuel consumption.

Checking tire inflation pressures regularly

Check and correct the tire inflation pressure as needed at least twice a month and before long trips.

An insufficient tire inflation pressure increases the rolling resistance and thus increases the fuel consumption and tire wear.

Driving off immediately

Do not allow the engine to warm up by leaving it running while the vehicle remains stationary. Instead, begin to drive at a moderate engine speed. This is the fastest way for the cold engine to reach its operating temperature.

Thinking ahead when driving

Avoid unnecessary acceleration and braking. To do so, maintain the appropriate distance from the vehicle in front of you. An anticipatory and smooth driving style reduces fuel consumption.

Avoiding high engine speeds

Driving at a low engine speed reduces fuel consumption and minimizes wear.

Using energy recovery

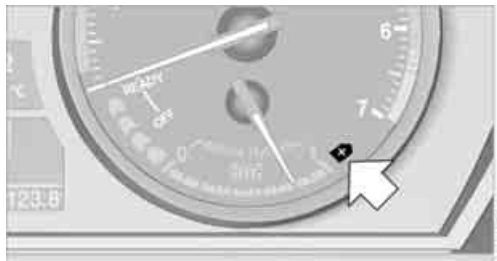

Energy recovery is displayed in the instrument panel.

Coasting mode

In coasting mode, e.g. when rolling toward a traffic signal, the high-voltage battery is charged by energy recovery.

Braking

The most efficient energy recovery and charging of the high-voltage battery are achieved with moderate braking.

Switching off functions currently not required

Functions such as air conditioning, seat heating, or rear window defrosting consume a lot of energy and require additional fuel. Their influence is particularly pronounced in city traffic and stop & go operation. For this reason, it is a good idea to switch these functions off when they are not really needed.

Having maintenance carried out

Have the vehicle serviced regularly in order to achieve the optimum economy and service life of your vehicle. BMW recommends having the maintenance performed by a BMW Sports Activity Vehicle Center. Also pay attention to the BMW maintenance system, refer to the BMW X6 Owner's Manual.

General driving notes

Driving through water

Maximum water depth: 17 in/45 cm

 Only drive through water up to the above-mentioned depth at no greater than walking speed; otherwise, the engine, electrical system, and transmission can be damaged. ◀

Braking safely

Your BMW is equipped with ABS as a standard feature. In situations that require it, it is best to brake with full force. Since the vehicle maintains steering responsiveness, you can still avoid possible obstacles with a minimum of steering effort.

Pulsation of the brake pedal, combined with sounds from the hydraulic circuits, indicate that ABS is in its active mode.

Hills

 To prevent overheating and the resulting reduced efficiency of the brake system, drive long or steep downhill gradients in the gear in which the least braking is required. Even light but consistent pressure on the brake pedal can lead to high temperatures, brake wear and possibly even brake failure. ◀

 With a fully charged high-voltage battery, the combustion engine is switched on when driving downhill in order to avoid overloading the high-voltage battery. ◀

The braking effect of the engine can be further increased by downshifting in the manual mode of the automatic transmission, if necessary into first gear, refer to page 18. This prevents an excessive strain on the brakes.

 Do not drive in idle or with drive readiness mode deactivated; otherwise, there is no braking action from the energy recovery or from the engine and no power-assistance for braking and steering.

Never allow floor mats, carpets or any other objects to protrude into the area of movement of the pedals and impair their operation. ◀

Corrosion on brake rotors

When the vehicle is driven only occasionally, during extended periods when the vehicle is not used at all, and in operating conditions where brake applications are less frequent, there is an increased tendency for corrosion to form on rotors, while contaminants accumulate on the brake pads. This occurs because the minimum pressure which must be exerted by the pads during brake applications to clean the rotors is not reached.

Should corrosion form on the brake rotors, the brakes will tend to respond with a pulsating effect that even extended application will fail to cure.





Mobility

This section helps you maintain your mobility by supplying important information on vital topics including fuels and lubricants, wheels and tires, service, maintenance and roadside assistance.

Refueling

⚠ Before refueling, deactivate drive readiness. When handling fuel, always observe all applicable precautionary measures and regulations. Never transport reserve fuel containers in the vehicle. These could become leaky and cause an explosion or a fire in an accident. ◀

Refueling

The BMW ActiveHybrid X6 is equipped with a special fuel tank. It is designed for special requirements that arise in the hybrid operation of the vehicle, e.g. alternating driving with the combustion engine or electric motors. Fuel vapors can cause pressure to build up in the fuel tank, which is reduced before the fuel tank catch is opened.

Preparation

Unlocking fuel filler door

1. Deactivate drive readiness, refer to page 15.
2. Push the button to start pressure compensation.

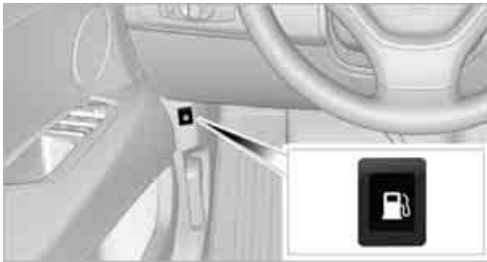

3. Messages indicate that the fuel filler door has been released and refueling is possible. In rare cases, the pressure decrease can take several seconds. A message on the Control Display indicates when the fuel filler door has been released.
4. Open the fuel filler door.
If the fuel filler door is not opened within 10 minutes after the fuel tank catch is

released, the fuel filler door locks again. Press the button again.

Opening fuel filler door

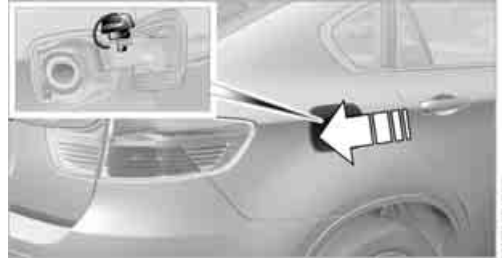

1. Open the fuel filler door. To do this, briefly press the lower edge.
The fuel filler door can only be opened if the fuel tank catch has been released.
2. Turn the fuel filler cap counterclockwise.
3. Place the fuel filler cap in the bracket attached to the fuel filler door.

Closing

Fit the cap and turn it clockwise until you clearly hear a click.

⚠ Do not crush the band attached to the cap; otherwise, the cap may not properly seal and fuel vapors can escape. ◀

Manually releasing fuel filler door

If an electrical malfunction should occur and the system does not release the fuel filler door, you can unlock the fuel filler door manually.

1. Open the right-hand side panel in the cargo bay.
2. Pull the knob with the gas pump symbol.

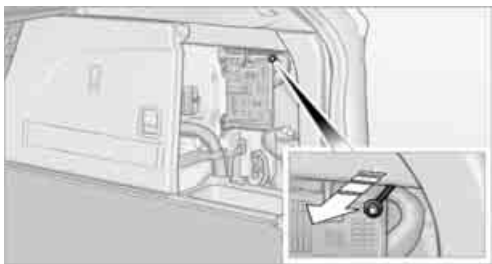

3. Open the fuel filler door. To do this, briefly press the lower edge.
4. Turn the fuel filler cap counterclockwise.
 - ⚠ When the fuel tank catch is opened, stay as far away from the vehicle as possible since gasoline and pressurized gasoline vapors may suddenly escape from the fuel tank. ◀

Observe the following when refueling

⚠ When handling fuels, follow the safety precautions posted at the filling station. Otherwise, there is a danger of personal injury or property damage. ◀

When refueling, insert the filler nozzle completely into the filler pipe. Avoid raising the filler nozzle during refueling, otherwise this leads to

- ▷ premature pump shutoff.
- ▷ a reduced efficiency of the fuel-vapor recovery system.

The fuel tank is full when the filler nozzle clicks off the first time.

Fuel tank capacity

Approx. 22.5 gallons/85 liters, including approx. 2.1 gallons/8 liters of reserve

⚠ Refuel as soon as possible once your cruising range falls below 30 miles/50 km, otherwise engine functions are not ensured and damage can occur. ◀

Fuel specifications

Gasoline engine: required fuel

⚠ Do not use leaded gasoline, otherwise damage to the catalytic converter will result.

Do not refuel with E85, i.e. fuel that consists of 85% ethanol, or Flex Fuel, otherwise permanent damage to the engine and the fuel supply system will result. ◀

Super Premium Gasoline/AKI 91

This gasoline is highly recommended.

However, you may also use gasoline with less AKI. The minimum AKI Rating is 89.

If you use gasoline with this minimum AKI Rating, the engine may produce knocking sounds when starting at high outside temperatures. This has no affect on the engine life.

⚠ Do not use gasoline below the specified minimum quality, otherwise engine damage can result. ◀

Use high-quality brands

Field experience has indicated significant differences in fuel quality: volatility, composition, additives, etc., among gasolines offered for sale in the United States and Canada. Fuels containing up to and including 10% ethanol or other oxygenates with up to 2.8% oxygen by weight, that is, 15% MTBE or 3% methanol plus an equivalent amount of co-solvent, will not void the applicable warranties with respect to defects in materials or workmanship.

⚠ The use of poor-quality fuels may result in drivability, starting and stalling problems especially under certain environmental conditions such as high ambient temperature and high altitude.



Should you encounter drivability problems which you suspect could be related to the fuel you are using, we recommend that you respond by switching to a recognized high-quality brand such as gasoline that is advertised as Top Tier Detergent Gasoline.

Failure to comply with these recommendations may also result in unscheduled maintenance. ◀

Wheels and tires

Tire inflation pressure

Tire inflation pressure BMW ActiveHybrid X6

Tire size	Pressure specifications in psi/kPa			
	Traveling speeds up to a max. of 100 mph/160 km/h		Traveling speeds including those exceeding 100 mph/160 km/h	
All pressure specifications in the table are indicated in psi/kilopascal with cold tires. Cold = ambient temperature				
	255/50 R 19 107 H M+S XL	35/240	38/260	38/260
Front: 275/40 R 20 106 W XL	38/260	-	41/280	-
Rear: 315/35 R 20 110 W XL	-	38/260	-	41/280
Front: 285/35 R 21 105 W XL	38/260	-	41/280	-
Rear: 325/30 R 21 108 W XL	-	38/260	-	41/280
Compact wheel*: T 155/80 R 19 114 M	60/420	60/420	60/420	60/420

More details on the permissible load and weights can be found on page [46](#).

Engine compartment

⚠ Only have work on the vehicle carried out by a BMW Sports Activity Vehicle Center or a repair shop that works in accordance with BMW guidelines and uses appropriately trained

personnel. Otherwise, there is the risk of life-threatening injury by electrocution due to the high voltage of the hybrid system. ◀

Engine compartment

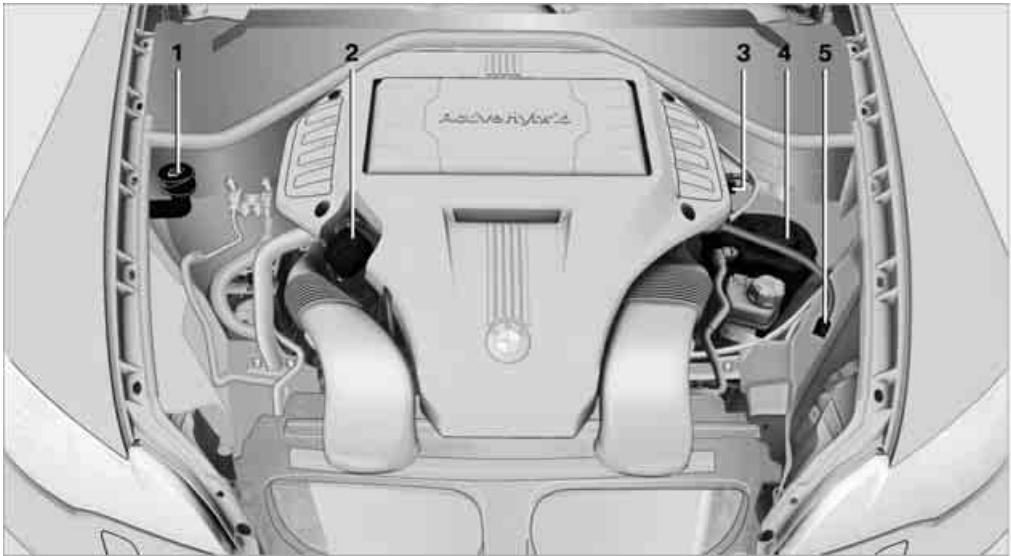

- 1 Filler neck for washing fluid of the headlamp and windshield washer system
- 2 Filler neck for engine oil, refer to Adding engine oil, BMW X6 Owner's Manual
- 3 Jump starting terminal plus/+, refer to page 37
- 4 Expansion tank for coolant
- 5 Jump starting terminal minus/-, refer to page 37

⚠ Do not work in the engine compartment with a tool that could damage the orange high-voltage cable or high-voltage components. Otherwise, there is the risk of fatal injury by electrocution. ◀

Replacing components

For more information on replacing parts, please refer to the BMW X6 Owner's Manual.

Working on the vehicle

Your BMW ActiveHybrid X6 is equipped with a high-voltage system.

The BMW X6 Owner's Manual only describes work on the vehicle that will not bring you into contact with the high-voltage system.

Have more extensive work on your vehicle carried out only by your BMW Sports Activity Vehicle Center or a repair shop that works according to BMW repair procedures with correspondingly trained personnel.

 Have maintenance and repair on the vehicle carried out only by your BMW Sports Activity Vehicle Center or a repair shop that works in accordance with BMW guidelines and uses appropriately trained personnel. Otherwise, there is the risk of life-threatening injury by electrocution due to the high voltage of the hybrid system. ◀

 Never touch the high-voltage components of the hybrid system; otherwise, there is the risk of life-threatening injury by electrocution due to the high voltage of the hybrid system. ◀

 Do not remove the cover panel of the cargo bay floor; otherwise, the high-voltage battery could be damaged. ◀

12 Volt batteries

Battery care

The 12 Volt batteries are maintenance-free, i.e. the electrolyte will last for the life of the battery when the vehicle is operated under temperate climatic conditions. Your BMW Sports Activity Vehicle Center will be glad to advise in all matters concerning the battery.

Charging batteries

Only charge the battery in the vehicle via the terminals in the engine compartment with the engine switched off. Connections, refer to Jump starting on page 37.

Disposal



Have old batteries disposed of following replacement at your BMW Sports Activity Vehicle Center or bring them to a collection point. Maintain the battery in an upright position for transport and storage. Always restrain the battery to prevent it from tipping over during transport. ◀

High-voltage battery

Battery care

Your BMW Sports Activity Vehicle Center will be glad to advise you in all matters concerning the high-voltage battery

Charging battery

Charging high-voltage battery, refer to Energy recovery on page 16 and Jump starting on page 37.

Giving and receiving assistance

Jump starting, charging high-voltage battery

Your BMW ActiveHybrid X6 is equipped with two types of battery:

- ▷ 12 Volt battery
- ▷ High-voltage battery

If the 12 Volt battery or high-voltage battery is dead, the combustion engine can be started with the aid of another vehicle using two jumper cables.

Only use jumper cables with fully insulated terminal clamps and do not deviate from the described procedure.

 To avoid the risk of potentially fatal injury, always avoid all contact with electrical components while the engine is running. Carefully adhere to the following sequence, both to prevent damage to one or both vehicles, and to guard against possible personal injuries. ◀

Identifying the dead battery

- ▷ Dead 12 Volt battery: Ignition cannot be switched on.
 - ▷ Dead high-voltage battery: Ignition can be switched on. Drive readiness cannot be activated.
- A message appears on the Control Display.

Preparation

1. Check whether the battery of the other vehicle is a 12 Volt battery and has approximately the same capacitance in Ah. This information can be found on the battery.
2. Switch off the engine of the assisting vehicle.
3. Switch off any electrical systems and components in both vehicles.

 There must not be any contact between the bodies of the two vehicles, otherwise there is a danger of shorting. ◀

Connecting jumper cables

 To avoid personal injury from sparks, follow this sequence when connecting jumper cables. ◀

In your BMW, the so-called jump-starting terminal in the engine compartment functions as the positive battery terminal, also refer to the engine compartment overview on page 35. The cover cap is marked with a + symbol.

1. Fold open the cover of the BMW starting-aid terminal. To do so, pull the tab.



2. Attach one end of the jumper cable plus/+ to the positive terminal of the battery or a starting-aid terminal of the vehicle providing assistance.
3. Attach the second end of the cable to the positive terminal of the battery or to a starting-aid terminal of the vehicle to be started.
4. Attach one end of the jumper cable minus/- to the negative terminal of the battery or to an engine or body ground of the assisting vehicle.

Your BMW has a special nut as body ground or negative pole.

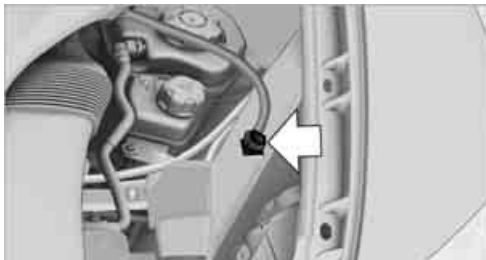

- Attach the second end of the cable to the negative terminal of the battery or to the engine or body ground of the vehicle to be started.

Charging: 12 Volt battery

- Start the engine on the assisting vehicle and activate drive readiness, allowing the assisting vehicle to run at idle for several minutes at slightly increased speed.
- Start the engine on your vehicle in the usual way.
If the first starting attempt is not successful, wait a few minutes before another attempt in order to allow the discharged battery to recharge.
- Let the engines run for a few minutes.
- Disconnect the jumper cables by reversing the connection sequence.

Have the battery checked if necessary.

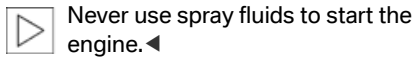

Charging: High-voltage battery

- Start the engine on the assisting vehicle and activate drive readiness, allowing the assisting vehicle to run at idle for several minutes at slightly increased speed.
- Switch on the ignition of your vehicle when prompted by the corresponding message on the Control Display. The charging begins.
- The charging is concluded when this is prompted by a corresponding message on the Control Display.
- Start the combustion engine of your own vehicle.
- Disconnect the jumper cables by reversing the connection sequence.

Have the hybrid system checked if necessary.

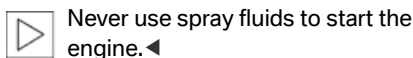

Charging interrupted

The charging may be interrupted, for example if the battery power of the assisting vehicle is insufficient.

Disconnect the jumper cables in the reverse of the sequence described above and contact your BMW Sports Activity Vehicle Center.

Tow-starting and towing

Getting towed:

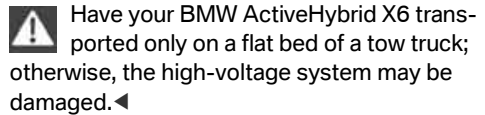

In special circumstances, it is possible to have the vehicle towed on the road for short distances, e.g. in order to remove the vehicle from a dangerous area.

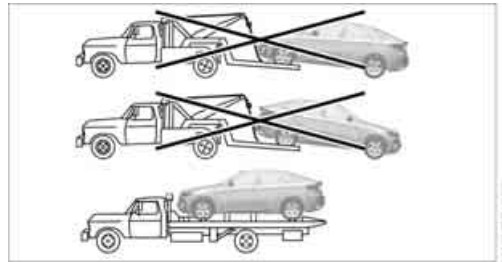

No tow-starting

The engine cannot be started by tow-starting. Start the engine by jump starting it, refer to page 37.

Have the cause of the starting difficulties eliminated.

Towing the vehicle

Towing your BMW ActiveHybrid X6 with a tow rope or tow bar is only possible in special circumstances for short distances, e.g. in order to remove the vehicle from a dangerous area. Otherwise, the hybrid system can be damaged.

Using a tow fitting

The screw-in tow-fitting should always be carried in the vehicle. It can be screwed in at the front or rear of the BMW.

It is located in the onboard toolkit under the floor panel flap in the cargo bay.

! Use only the tow fitting provided with the vehicle and screw it all the way in. Use the tow fitting for towing only on roads. Avoid lateral loading of the tow fitting, e.g. do not lift the vehicle by the tow fitting. Otherwise damage to the tow fitting and the vehicle can occur. ◀

Access to screw thread

Cover panel on left and right side of bumper: press on the arrow symbol on the cover panel.

Front:

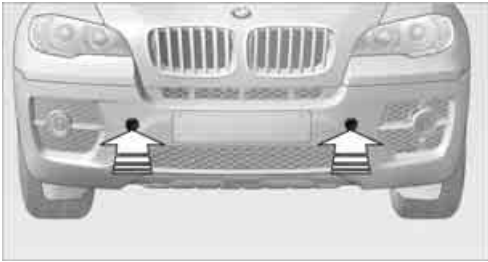

Rear:

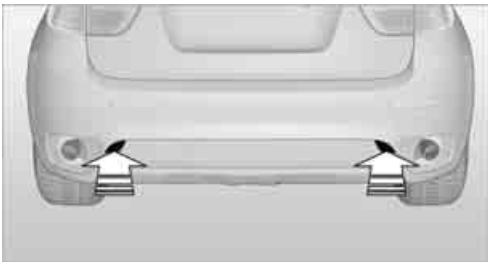

Towing methods

! Do not lift vehicle by tow fitting or body and chassis parts, otherwise damage may result. ◀

In some countries, towing with tow bars or ropes in public traffic is not permitted. Familiarize yourself with the regulations on towing in the respective country.

With tow bar

! The towing vehicle may not be lighter than the vehicle to be towed, otherwise it will not be possible to reliably control vehicle response. ◀

The tow fittings used should be on the same side on both vehicles. Should it prove impossible to avoid mounting the tow bar at an offset angle, observe the following:

- ▷ Clearance and maneuvering capability will be sharply limited during cornering.
- ▷ When mounted at an angle, the tow bar will exert lateral forces, tending to push the vehicle sideways.

! Only attach the tow bar to the tow fittings, as attachment to other vehicle parts can lead to damage. ◀

With tow rope

When starting off in the towing vehicle, make sure that the tow rope is taut.

! To avoid jerking and the associated stresses on vehicle components when towing, always use nylon ropes or nylon straps. Only attach tow ropes to the tow fittings, as attachment to other vehicle parts can lead to damage. ◀

Hybrid system safety

Working on the vehicle

The hybrid system of the BMW ActiveHybrid X6 is a closed system.

Safety is assured as long as no work is performed on the technical components.

Therefore, have changes to and work on the vehicle, e.g. installation of accessories, carried out only by your BMW Sports Activity Vehicle Center or by a repair shop that works in accordance with BMW guidelines using appropriately trained personnel.

! Have maintenance and repair of the vehicle carried out only by the service department or by a repair shop that works in accordance with BMW guidelines using appropriately

trained personnel. Otherwise, there is the risk of life-threatening injury by electrocution due to the high voltage of the hybrid system. ◀

Hybrid system: Contact with water

The hybrid system is generally safe, even in the following sample situations:

- ▷ Water in the footwell, e.g. when rain showers occur with an open glass roof.
- ▷ The vehicle is in water, e.g. in a flood.
- ▷ Fluid escapes in the cargo bay.

In these cases, there is no danger of being injured by electrocution. Other types of damage to the vehicle are possible.

Hybrid system: Automatic deactivation

In the event of an accident, the hybrid system is switched off automatically in order to protect passengers and other road users from injury.

The high-voltage system is automatically switched off in the following sample situations:

- ▷ Sensors of the airbag system detect an accident
- ▷ Obstacles on the road damage the underbody and high-voltage cables



After an accident, do not touch any exposed high-voltage components. Otherwise, there is the risk of life-threatening injury by electrocution due to the high voltage of the hybrid system. ◀

Also follow the instructions for what to do after an accident.

What to do after an accident

If you should get into an accident with your vehicle, the following safety precautions must be taken with regard to the hybrid system:

- ▷ Secure the accident site.
- ▷ Immediately inform the paramedics, police, or fire department of the fact that it is a vehicle equipped with a hybrid system.

- ▷ Move the selector lever into position P, set the parking brake, and switch off drive readiness.
- ▷ Do not touch any orange high-voltage cables and connectors or high-voltage components. Otherwise, there is the risk of life-threatening injury by electrocution.
- ▷ Do not inhale gases emanating from the high-voltage battery. Stay away from the vehicle if necessary.
- ▷ Contact a service center in order to ascertain the damage.



Reference

This chapter contains technical data and the index that is the fastest way to find the information you are looking for.

Technical data

Drive system

Combustion engine

		BMW ActiveHybrid X6
Displacement	cu in/cm ³	268.2/4,395
No. of cylinders		8
Maximum output	hp	400
at engine speed	rpm	5,500-6,400
Maximum torque	lb ft/Nm	450/610
at engine speed	rpm	1,750-4,500

Hybrid system

Simultaneous operation of combustion engine and electric motors.

		BMW ActiveHybrid X6
Maximum output	hp	480
Maximum torque	lb ft/Nm	575/780

High-voltage battery

		BMW ActiveHybrid X6
Type		NiMH
Output	kW	57

Dimensions

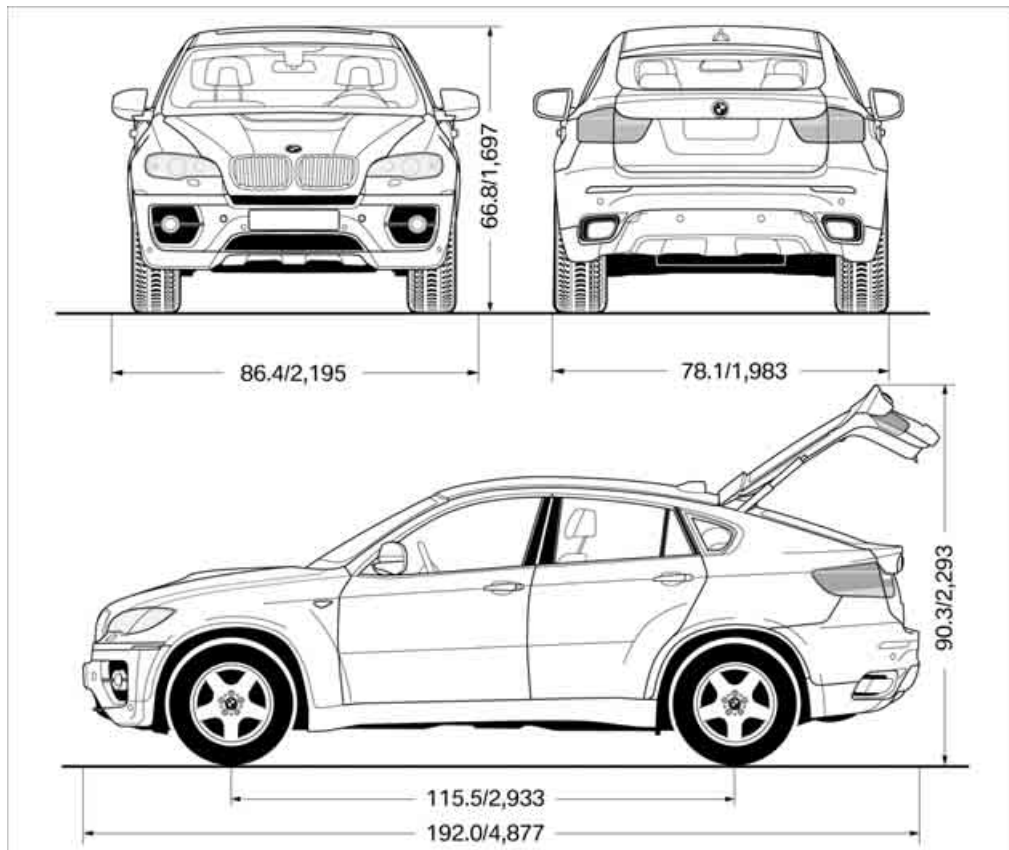

All dimensions given in inches/mm.

Smallest turning circle diam.: 42.0 ft/12.8 m

Height with roof rack*: 67.2 in/1,706 mm

With mixed tires* the vehicle width may exceed the specified dimension.

Weights

ActiveHybrid X6		
Approved gross vehicle weight	lbs./kg	6,669/3,025
Load	lbs./kg	882/400
Approved front axle weight	lbs./kg	3,285/1,490
Approved rear axle weight	lbs./kg	3,505/1,590
Approved roof load capacity	lbs./kg	220/100
Cargo bay capacity	cu ft/l	25.6-59.7/ 470-1,350

Never exceed either the approved axle loads or the gross vehicle weight.

Capacities

			Notes
Fuel tank including reserve	gal/liters	approx. 22.5/85 approx. 2.1/8	Also refer to BMW X6 Owner's Manual
Windshield washer with headlamp washer system	US quarts/liters	approx. 6.9/6.5	

Everything from A to Z

Index

A

- Accident, what to do after [40](#)
- After an accident [40](#)
- AKI, refer to Fuel specifications [33](#)
- Alterations, technical, refer to For your own safety [5](#)
- Approved axle weights, refer to Weights [46](#)
- Approved gross vehicle weight, refer to Weights [46](#)
- Axle weights, refer to Weights [46](#)

B

- Battery
 - 12 V battery [36](#)
 - charging [36](#)
 - high-voltage battery [36](#)
- Battery disposal
 - vehicle battery [36](#)
- BMW homepage [4](#)
- BMW website [4](#)
- Brake rotors [28](#)
- Brakes
 - breaking-in [26](#)
 - refer to Braking safely [27](#)
- Brake system
 - breaking-in [26](#)
 - disk brakes [28](#)
- Braking safely [27](#)
- Breaking-in rear axle differential [26](#)
- Break-in period [26](#)
- Button for starting engine [13](#)

C

- Capacities [46](#)
- Capacity of cargo bay [46](#)

- Cargo bay
 - capacity [46](#)
- Car wash
 - before driving in [15](#)
- Changes, technical, refer to For your own safety [5](#)
- CHARGE, Energy recovery [16](#)
- Charge state display [21](#)
- Charging high-voltage battery [37](#)
- Checking the air pressure, refer to Tire inflation pressure [34](#)
- Climate [23](#)
- Closing fuel filler cap [32](#)
- Cockpit [8](#)
- Components, high-voltage system [12](#)
- Consumption display
 - charge state display [21](#)
- Copyright [2](#)
- Cruise control [19](#)
- Cylinders, refer to Drive system [44](#)

D

- Data
 - capacities [46](#)
 - dimensions [45](#)
 - engine [44](#)
 - high-voltage system [44](#)
 - hybrid system [44](#)
 - technical data [44](#)
 - weights [46](#)
- Dimensions [45](#)
- Displacement, refer to Drive system [44](#)
- Displays, refer to Instrument panel [8](#)
- Disposal
 - vehicle battery [36](#)

- DRIVE, Driving with combustion engine [16](#)
- Drive readiness [14](#)
- Driving through water [27](#)
- Driving tips, refer to General driving notes [26](#)

E

- eBOOST [16](#)
- eDRIVE, Electric driving [15](#)
- Electrical malfunction
 - fuel filler door [32](#)
- Electric drive readiness [14](#)
- Electric driving, eDRIVE [15](#)
- Emergency operation, refer to Manually operating fuel filler door [32](#)
- Energy recovery, CHARGE [16](#)
- Engine
 - breaking-in [26](#)
 - data [44](#)
 - speed [44](#)
 - starting [14](#)
- Engine compartment [35](#)
- Engine output, refer to Drive system [44](#)
- Engine speed [44](#)
- Eye for tow-starting and towing, refer to Tow fitting [39](#)

F

- Footbrake, refer to Braking safely [27](#)
- For your own safety [5](#)

Fuel 33

- capacity 46
 - display 22
 - high-quality brands 33
 - quality 33
 - saving 26
 - specifications 33
- Fuel clock, refer to Fuel gauge 22
- Fuel display, refer to Fuel gauge 22
- Fuel filler door 32
- closing 32
 - releasing manually 32

G

- Gasoline, refer to Required fuel 33
- Gasoline display, refer to Fuel gauge 22
- General driving notes 26, 27
- Getting towed 38
- Gross vehicle weight, refer to Weights 46

H

- Height, refer to Dimensions 45
- High-voltage battery 36
- High-voltage system
- components 12
- High water, refer to Driving through water 27
- Hills 27
- Homepage 4
- Hybrid system
- air-conditioning functions 23
 - components 12
 - contact with water 40
 - deactivation 40
 - display 21
 - functions 13
 - safety 39
- Hybrid system safety 39

I

- Ignition 13
- switched on 13
- Ignition key position 1, refer to Radio readiness 13
- Ignition key position 2, refer to Ignition on 13
- Imprint 2
- Inflation pressure, refer to Tire inflation pressure 34
- Instrument cluster, refer to Instrument panel 8
- Instrument panel 8

J

- Jumpering, refer to Jump starting 37
- Jump starting 37

K

- Knock control 33

L

- Length, refer to Dimensions 45
- Luggage compartment capacity, refer to Cargo bay capacity 46

M

- Malfunction
- fuel filler door 32
- Manual operation
- fuel filler door 32

N

- Noises, refer to Cooling of the high-voltage system 23
- Nylon rope, refer to Tow-starting and towing 38

O

- Octane ratings, refer to Fuel specifications 33

P

- Power, refer to Drive system 44
- Pressure, tires 34
- Pressure compensation, refueling 32

R

- Radio position, refer to Radio readiness 13
- Radio readiness 13
- switched on 13
- Refueling 32
- preparation 32
 - pressure compensation 32
- Regeneration, refer to Energy recovery 16
- Reserve warning, refer to Fuel gauge 22
- Roof load capacity 46
- Rope, refer to Tow-starting and towing 38

S

- Safety 5
- Screw thread for tow fitting 39
- Silent start 14
- Speedometer 8
- Sport program, manual mode M/S 18
- Start/Stop button 13
- Starting, refer to Starting engine 14
- Starting assistance, refer to Jump starting 37
- Starting difficulties, jump starting 37
- Status of this Owner's Manual at time of printing 5
- Summer tires, refer to Wheels and tires 34

Symbols [4](#)

T

Tank contents, refer to
Capacities [46](#)

Technical alterations, refer to
For your own safety [5](#)

Technical data [44](#)

Teleservice Report [5](#)

Tempomat, refer to Cruise
control [19](#)

The individual vehicle [5](#)

Tire inflation pressures [34](#)

Tires

– inflation pressure [34](#)

Torque

– engine [44](#)

Tow fitting [39](#)

Towing [38](#)

– tow fitting [39](#)

Tow-starting [38](#)

Turning circle, refer to
Dimensions [45](#)

Turn signals

– indicator lamp [8](#)

Two-Mode Active

Transmission [16](#)

U

Used batteries

– refer to Disposal [36](#)

V

Vehicle

– breaking-in [26](#)

– measurements, refer to
Dimensions [45](#)

– weights [46](#)

Vehicle battery, refer to

12 Volt batteries [36](#)

W

Water on roads, refer to

Driving through water [27](#)

Website [4](#)

Weights [46](#)

What to do after an
accident [40](#)

Wheelbase, refer to
Dimensions [45](#)

Wheels and tires [34](#)

Width, refer to Dimensions [45](#)

More about BMW

bmwusa.com



The Ultimate
Driving Machine

01 41 2 603 632 ue

