

Owner's Manual
for Vehicle



The Ultimate
Driving Machine



328i
328i xDrive
335i
335i xDrive
335is
M3

Owner's Manual for Vehicle

Congratulations, and thank you for choosing a BMW.

Thorough familiarity with your vehicle will provide you with enhanced control and security when you drive it. We therefore have this request:

Please take the time to read this Owner's Manual and familiarize yourself with the information that we have compiled for you before starting off in your new vehicle. It contains important data and instructions intended to assist you in gaining maximum use and satisfaction from your BMW's unique range of technical features. The manual also contains information on maintenance designed to enhance operating safety and contribute to maintaining the value of your BMW throughout an extended service life.

This manual is supplemented by a Service and Warranty Information Booklet for US models or a Warranty and Service Guide Booklet for Canadian models.

We wish you an enjoyable driving experience.

BMW Group

© 2010 Bayerische Motoren Werke
Aktiengesellschaft
Munich, Germany
Reprinting, including excerpts, only with the
written consent of BMW AG, Munich.
US English II/10
Printed on environmentally friendly paper,
bleached without chlorine, suitable for recycling.

Contents

The quickest way to find special topics is to consult the index, refer to page [184](#).

Using this Owner's Manual

- 4 Notes
- 6 Reporting safety defects

At a glance

- 10 Cockpit

Controls

- 18 Opening and closing
- 36 Adjustments
- 47 Transporting children safely
- 50 Driving
- 71 Controls overview
- 79 Technology for driving comfort and safety
- 91 Lamps
- 97 Climate
- 104 Practical interior accessories

Driving tips

- 120 Things to remember when driving

Mobility

- 128 Refueling
- 130 Wheels and tires
- 144 Under the hood
- 148 Maintenance
- 150 Care
- 154 Replacing components
- 159 Giving and receiving assistance
- 164 Indicator and warning lamps

Reference

- 178 Technical data
- 184 Everything from A to Z

Notes

Using this Owner's Manual

We have tried to make all the information in this Owner's Manual easy to find. The fastest way to find specific topics is to refer to the detailed index at the back of the manual. If you wish to gain an initial overview of your vehicle, you will find this in the first chapter.

Should you sell your BMW some day, please remember to hand over the Owner's Manual as well; it is an important component of your vehicle.

Additional sources of information

Should you have any other questions, your BMW center will be glad to advise you at any time.

Information on BMW, e.g. on technical aspects, can also be found on the Internet at www.bmwusa.com.

Symbols used

 Indicates precautions that must be followed precisely in order to avoid the possibility of personal injury and serious damage to the vehicle. ◀

 Indicates information that will assist you in gaining the optimum benefit from your vehicle and enable you to care more effectively for your vehicle. ◀

 Refers to measures that can be taken to help protect the environment. ◀

◀ Marks the end of a specific item of information.

* Indicates special equipment, country-specific equipment and optional accessories, as well as equipment and functions not yet available at the time of printing.

Symbols on vehicle components

 Indicates that you should consult the relevant section of this Owner's Manual for information on a particular part or assembly.

The individual vehicle

When you ordered your BMW, you chose various items of equipment. This Owner's Manual describes the entire array of options and equipment available with a specific BMW model.

Please bear in mind that the manual may contain information on accessories and equipment that you have not specified for your own vehicle. Sections describing options and special equipment are marked by asterisks* to assist you in identifying possible differences between the descriptions in this manual and your own vehicle's equipment.

If equipment in your BMW is not described in this Owner's Manual, please refer to the accompanying Supplementary Owner's Manuals.

Editorial notice

BMW pursues a policy of continuous, ongoing development that is conceived to ensure that our vehicles continue to embody the highest quality and safety standards combined with advanced, state-of-the-art technology. For this reason, it is possible in exceptional cases that features described in this Owner's Manual could differ from those on your vehicle.

For your own safety

Maintenance and repair

 Advanced technology, e.g. the use of modern materials and powerful electronics, requires specially adapted maintenance and repair methods. You should therefore have the corresponding work on your vehicle performed only by your BMW center or at a workshop that works according to BMW repair procedures with correspondingly trained personnel. If this work is not carried out properly, there is a danger of subsequent damage and related safety hazards. ◀

Parts and accessories

 For your own safety, use genuine parts and accessories approved by BMW.

When you purchase accessories tested and approved by BMW and Original BMW Parts, you simultaneously acquire the assurance that they have been thoroughly tested by BMW to ensure optimum performance when installed on your vehicle.

BMW warrants these parts to be free from defects in material and workmanship.

BMW will not accept any liability for damage resulting from installation of parts and accessories not approved by BMW.

BMW cannot test every product made by other manufacturers to verify if it can be used on a BMW safely and without risk to either the vehicle, its operation, or its occupants.

Original BMW Parts, BMW Accessories and other products approved by BMW, together with professional advice on using these items, are available from all BMW centers.

Installation and operation of accessories not approved by BMW, such as alarms, radios, amplifiers, radar detectors, wheels, suspension components, brake dust shields, telephones, including operation of any mobile phone from within the vehicle without using an externally mounted antenna, or transceiver equipment, for instance, CBs, walkie-talkies, ham radio or similar accessories, may cause extensive damage to the vehicle, compromise its safety, interfere with the vehicle's electrical system or affect the validity of the BMW Limited Warranty. See your BMW center for additional information. ◀

 Maintenance, replacement, or repair of the emission control devices and systems may be performed by any automotive repair establishment or individual using any certified automotive part. ◀

California Proposition 65 warning

California law requires us to issue the following warning:

 Engine exhaust and a wide variety of automobile components and parts, including components found in the interior furnishings in a vehicle, contain or emit chemicals known to the State of California to cause cancer and birth defects and reproductive harm. In addition, certain fluids contained in vehicles and certain products of component wear contain or emit chemicals known to the State of California to cause cancer and birth defects or other reproductive harm.

Battery posts, terminals and related accessories contain lead and lead compounds. Wash your hands after handling.

Used engine oil contains chemicals that have caused cancer in laboratory animals. Always protect your skin by washing thoroughly with soap and water. ◀

Service and warranty

We recommend that you read this publication thoroughly.

Your BMW is covered by the following warranties:

- ▷ New Vehicle Limited Warranty
- ▷ Rust Perforation Limited Warranty
- ▷ Federal Emissions System Defect Warranty
- ▷ Federal Emissions Performance Warranty
- ▷ California Emission Control System Limited Warranty

Detailed information about these warranties is listed in the Service and Warranty Information Booklet for US models or in the Warranty and Service Guide Booklet for Canadian models.

Your vehicle has been specifically adapted and designed to meet the particular operating conditions and homologation requirements in your country and continental region in order to deliver the full driving pleasure while the vehicle is operated under those conditions. If you wish to operate your vehicle in another country or region, you may be required to adapt your vehicle to meet different prevailing operating conditions and homologation requirements. You should also be aware of any applicable warranty limitations or exclusions for such country or region. In such case, please contact Customer Relations for further information.

Reporting safety defects

For US customers

The following only applies to vehicles owned and operated in the US.

If you believe that your vehicle has a defect which could cause a crash or could cause injury or death, you should immediately inform the National Highway Traffic Safety Administration, NHTSA, in addition to notifying BMW of North America, LLC, P.O. Box 1227, Westwood, New Jersey 07675-1227, Telephone 1-800-831-1117.

If NHTSA receives similar complaints, it may open an investigation, and if it finds that a safety defect exists in a group of vehicles, it may order a recall and remedy campaign. However, NHTSA cannot become involved in individual problems between you, your center, or BMW of North America, LLC.

To contact NHTSA, you may call the Vehicle Safety Hotline toll-free at 1-888-327-4236 (TTY: 1-800-424-9153); go to <http://www.safercar.gov>; or write to: Administrator, NHTSA, 400 Seventh Street, SW., Washington, DC 20590. You can also obtain other information about motor vehicle safety from <http://www.safercar.gov>

For Canadian customers

Canadian customers who wish to report a safety-related defect to Transport Canada, Defect Investigations and Recalls, may call 1-800-333-0510 toll-free from anywhere in Canada or 1-613-993-9851 from the Ottawa region and from other countries, or contact Transport Canada by mail at: Transport Canada, ASFAD, Place de Ville, Tower C, 330 Sparks Street, Ottawa, ON, K1A 0N5.

You can also obtain other information about motor vehicle safety from <http://www.tc.gc.ca>











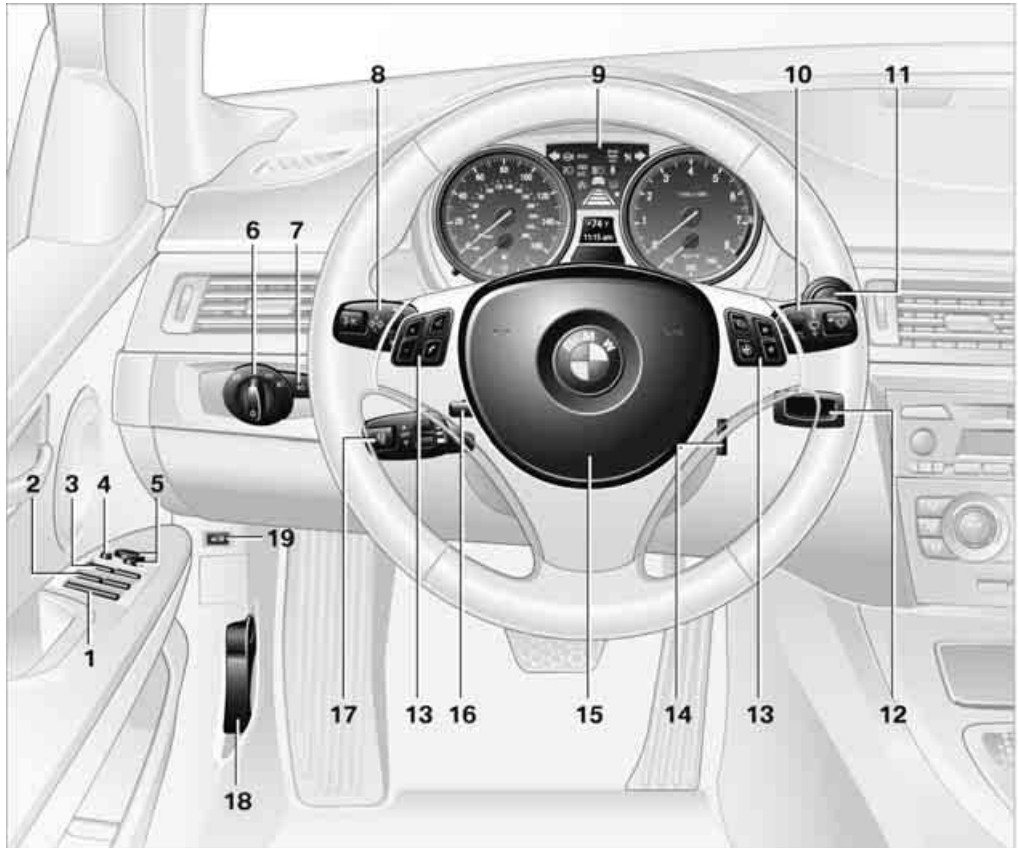

At a glance







This overview of buttons, switches and displays is intended to familiarize you with your vehicle's operating environment. The section will also assist you in becoming acquainted with the control concepts and options available for operating the various systems.

Cockpit



Around the steering wheel: controls and displays



- | | |
|---|---|
| <p>1  Convertible: opening and closing windows jointly 29</p> <p>2  Convertible: opening and closing rear windows 29</p> <p>3  Opening and closing front windows 29</p> <p>4 Folding exterior mirrors in and out* 44</p> <p>5 Adjusting exterior mirrors, automatic curb monitor* 44</p> | <p>6  Parking lamps 91</p> <p> Low beams 91</p> <p> Automatic headlamp control* 91</p> <p> Adaptive light control* 93</p> <p> High-beam assistant* 94</p> <p>7  Fog lamps* 95</p> |
|---|---|

- 8  Turn signals 60
-  High beams, headlamp flasher 93
-  High-beam assistant* 94
-  Roadside parking lamps* 93
-  Computer 72
-  Settings and information about the vehicle 74

9 Instrument cluster 12

- 10  Windshield wipers 61
-  Rain sensor* 61





- 11  Switching the ignition on/off and starting/stopping the engine 50

12 Ignition lock 50

13 Buttons on the steering wheel

-  Telephone*:
Accepting and ending a call; dialing* the selected phone number; redialing if no phone number is selected

-  Volume

-  Changing the radio station
-  Interrupting a traffic bulletin
-  Selecting a music track
-  Scrolling through the radial list

-  Next entertainment source

-  Recirculated-air mode 101

- 14  Steering wheel heating* 46

15 Horn, entire surface

16 Adjusting the steering wheel 46

- 17  Cruise control* 62

-  Active cruise control* 64

18 Releasing the hood 144

19 Opening the trunk lid 24

Instrument cluster



- 1 Speedometer
- 2 Indicator lamps for turn signals
- 3 Indicator and warning lamps [13](#)
- 4 Displays for active cruise control* [64](#)
- 5 Tachometer [71](#)
- 6 Engine oil temperature [72](#)
- 7 Display for
 - ▷ Clock [71](#)
 - ▷ Outside temperature [71](#)
 - ▷ Indicator and warning lamps [77](#)
- 8 Display for
 - ▷ Position of automatic transmission* [53](#)
 - ▷ Gear indicator in 7-gear Sports automatic transmission with double clutch* [55](#)
 - ▷ Computer [72](#)
 - ▷ Date of next scheduled service, and remaining distance to be driven [76](#)
 - ▷ Odometer and trip odometer [71](#)
 - ▷ High-beam assistant* [94](#)
 - ▷ Initializing the Flat Tire Monitor* [83](#)
 - ▷ Resetting the Tire Pressure Monitor* [85](#)
 - ▷ Checking engine oil level* [145](#)
 - ▷ Settings and information [74](#)
 - ▷ ▲ There is a Check Control message [77](#)
- 9 Fuel gauge [72](#)
- 10 Resetting the trip odometer [71](#)

Indicator and warning lamps

The concept

Indicator and warning lamps can light up in a variety of combinations and colors.

Several of the lamps are checked for proper functioning and light up temporarily when the engine is started or the ignition is switched on.

What to do in case of a malfunction

A list of all indicator and warning lamps, as well as notes on possible causes of malfunctions and on how to respond, can be found starting on page [164](#).

Around the center console: controls and displays



- 1 Coupe: microphone for telephone* in hands-free mode
Convertible: microphone on steering column
- 2 SOS: initiating an Emergency Request call* 159
- 3 Reading lamps 96
- 4 Coupe: glass roof, electric* 30
- 5 Interior lamps 95
- 6 Passenger airbag status lamp* 89
- 7 Hazard warning flashers
- 8 Dynamic Traction Control DTC 81
- 9 Central locking system 23
- 10 Radio, refer to separate Owner's Manual
- 11 Air conditioner or automatic climate control*



Air distribution for air conditioner 98



Air distribution to the windshield* 100



Air distribution to the upper body area* 100



Air distribution to the footwell* 100

AUTO

Automatic air distribution and flow rate* 101



Cooling function 102



Automatic recirculated-air control AUC* and recirculated-air mode 101



Recirculated-air mode 98



Maximum cooling* 101

ALL

ALL program* 102



Air volume 98, 101



Defrosting windows* 102



Rear window defroster 99, 102



Heated seats* 41

12



Park Distance Control PDC* 79



Coupe:
Roller sun blind* 107



Coupe:
Hill Descent Control HDC* 81

13



Convertible:
Opening and closing retractable hardtop 32



A close-up, blue-tinted photograph of a car's interior controls. The image shows a circular air vent on the left, a gear shift lever in the center, and a handbrake on the right. The background is blurred, focusing attention on the mechanical details of the vehicle's interior.

Controls

This chapter is intended to provide you with information for complete control of your vehicle. All features and accessories that are useful for driving and your safety, comfort and convenience, are described here.

Opening and closing

Remote control



Each remote control contains a rechargeable battery that is automatically recharged when it is in the ignition lock while the car is being driven. Use each remote control at least twice a year for longer road trips in order to maintain the batteries' charge status. In cars with Comfort Access*, the remote control contains a replaceable battery, refer to page 29.

The settings called up and implemented when the car is unlocked depend on which remote control is used to unlock the car, refer to Personal Profile, next column.

In addition, information about service requirements is stored in the remote control, refer to Service data in the remote control, page 148.

Integrated key



Press button 1 to release the key.

The integrated key fits the following locks:

- ▷ Glove compartment, refer to page 107
- ▷ Driver's door, refer to page 23

New remote controls

Your BMW center can supply new remote controls with integrated keys as additional units or as replacements in the event of loss.

Personal Profile

The concept

You can set many of your BMW's functions to suit your personal needs and preferences. Without any action on your part, Personal Profile ensures that most of these settings are stored for the remote control currently in use. When you unlock the car, the remote control used for the purpose is recognized and the settings stored for it are called up and implemented.

This means that your personal settings will be activated for you, even if in the meantime your car was used by someone else with another remote control and the corresponding settings. The individual settings are stored for a maximum of four remote controls. They are stored for two remote controls if Comfort Access* is in use.

Personal Profile settings

For more information on specific settings, refer to the specified pages.

- ▷ Response of the central locking system when the car is unlocked, refer to page 19
- ▷ Automatic locking of the vehicle, refer to page 23
- ▷ Automatic call-up* of the driver's seat position, refer to page 41
- ▷ Triple turn signal activation, refer to page 60

- ▷ Settings for the display in the instrument cluster:
 - ▷ 12h/24h format of the clock, refer to page 75
 - ▷ Date format, refer to page 75
 - ▷ Units of measure, refer to page 75
- ▷ Light settings:
 - ▷ Pathway lighting, refer to page 91
 - ▷ Daytime running lights, refer to page 92
 - ▷ High-beam assistant, refer to page 94
- ▷ Automatic climate control*: AUTO program, cooling function and automatic recirculated-air control activated/deactivated, temperature, air volume and distribution, refer to page 100 ff
- ▷ Entertainment:
 - ▷ Speed-dependent volume control, refer to separate Owner's Manual

Central locking system

The concept

The central locking system functions when the driver's door is closed.

The system simultaneously engages and releases the locks on the following:

- ▷ Doors
- ▷ Trunk lid
- ▷ Fuel filler flap
- ▷ Convertible: glove compartment

Operating from outside

- ▷ Via the remote control
- ▷ Via the door lock*
- ▷ In cars with Comfort Access*, via the handles on the driver's and front passenger doors

In addition, if the remote control is used, the welcome lamps, interior lamps and the door's courtesy lamps* are switched on or off. The alarm system* is also armed or disarmed. For further details of the alarm system, refer to page 26.

Operating from inside

By means of the button for central locking, refer to page 23.

In the event of a sufficiently severe accident, the central locking system unlocks automatically. In addition, the hazard warning flashers and interior lamps come on.

Opening and closing: Using the remote control

 Persons or animals in a parked vehicle could lock the doors from the inside. You should therefore take the remote control with you when you leave the vehicle so that the latter can be opened from outside. ◀

 Convertible: to operate the retractable hardtop with the remote control, the doors and trunk lid must be closed and the cargo area partition must be folded down and engaged on both sides. Refer also to page 32. ◀

Unlocking

Press the  button.

The interior lamps, the courtesy lamps* and the welcome lamps come on.

Setting unlocking characteristics

You can set whether only the driver's door or the entire vehicle is to be unlocked when the button is pressed for the first time.

For operating principle, refer to page 74.

1. Switch on the ignition, refer to page 50.
2. Lightly push button 1 in the turn indicator lever up or down repeatedly until the symbol appears in the display accompanied by the word "SET".



3. Press button 2.
4. Lightly push button 1 in the turn indicator lever down repeatedly until the symbol appears in the display.



5. Press button 2.
6. Use button 1 to select:
 - ▷ Press the button once to unlock only the driver's door and the fuel filler flap. Press the button twice to unlock the entire vehicle.
 - ▷ Press the button once to unlock the entire vehicle.

7. Press button 2.
The setting is stored for the remote control currently in use.

Coupe: convenient opening

Hold the button down.
The windows and the glass roof* are opened.

Convertible: convenient opening*

When you are close to the vehicle, the remote control for Comfort Access can be used to open the retractable hardtop.

Hold the button down.
The windows and the retractable hardtop are opened if the doors are closed.

If you continue pressing the button, the windows move up.

Watch during the opening process to ensure that no one is injured. Releasing the button interrupts the opening process. ◀

Locking

Press the LOCK button.

Convertible: convenient closing*

When you are close to the vehicle, the remote control for Comfort Access can be used to close the retractable hardtop and the windows.

Hold the LOCK button down.
The retractable hardtop and the windows are closed.

Watch during the closing process to ensure that no one is injured. Releasing the button interrupts the closing process. ◀

Switching on interior lamps

While the car is locked:

Press the LOCK button.

You can also use this function to locate your vehicle in parking garages etc.

Unlocking the trunk lid

Press the  button for approx. 1 second.



The trunk lid opens a short distance, regardless of whether it was locked or unlocked.

 The trunk lid swings back and up when opened. Ensure that there is sufficient clearance. To avoid locking yourself out by accident, do not place the remote control in the cargo area. A previously locked trunk lid is locked again after closing.

Before and after each trip, check that the trunk lid has not been inadvertently unlocked. ◀

Convertible: convenient loading*

When you are close to the vehicle, the remote control for Comfort Access can be used to partially raise the open hardtop for more convenient loading of the cargo area.

1. Briefly press the  button and, within one second, press again and hold until the retractable hardtop stops in an intermediate position. The trunk lid opens slightly.
2. Open the trunk lid, press the cargo area partition upward and stow the cargo in the cargo area.
3. Press down the cargo area partition until it engages on both sides and close the trunk lid.
4. Press the  button for a longer period to fold the retractable hardtop back in.

Confirmation signals

You can activate or deactivate the confirmation signals.



For operating principle, refer to page 74.



1. Switch on the ignition, refer to page 50.
2. Lightly push button 1 in the turn indicator lever up or down repeatedly until the symbol appears in the display accompanied by the word "SET".



3. Press button 2.
4. Lightly push button 1 in the turn indicator lever down repeatedly until the desired symbol appears in the display.



- ▷  Confirmation signal during unlocking
 - ▷  Confirmation signal during locking
5. Press button 2.

6. Use button **1** to select:
 - ▷  The hazard warning flashers light up during unlocking/locking.
 - ▷  An acoustic signal sounds during unlocking/locking.
 - ▷  The hazard warning flashers light up and an acoustic signal* sounds during unlocking/locking.
 - ▷ **off**
The function is deactivated.
7. Press button **2**.
The setting is stored.

Malfunctions

The remote control may malfunction due to local radio waves. If this occurs, unlock and lock the car at the door lock with the integrated key.

Coupe: in vehicles without an alarm system* or Comfort Access*, only the driver's door can be locked and unlocked with the integrated key via the door lock.

Convertible: if hardtop movement via the remote control is interrupted briefly, the movement will be completed more quickly if you keep the corresponding button pressed continuously.

If the car can no longer be locked with a remote control, the battery in the remote control is discharged. Use the remote control on an extended trip to recharge the battery, refer to page 18. The remote control for Comfort Access* contains a battery that may have to be changed, refer to page 29.

For US owners only

The transmitter and receiver units comply with part 15 of the FCC/Federal Communications Commission regulations. Operation is governed by the following:

FCC ID:
LX8766S
LX8766E
LX8CAS

Compliance statement:

This device complies with part 15 of the FCC Rules. Operation is subject to the following two conditions:

- ▷ This device must not cause harmful interference, and
- ▷ this device must accept any interference received, including interference that may cause undesired operation.

 Any unauthorized modifications or changes to these devices could void the user's authority to operate this equipment. ◀

Opening and closing: Using the door lock

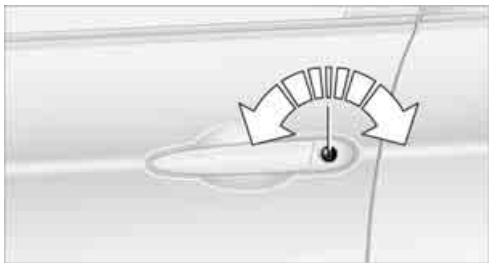

You can set the way in which the car is unlocked, refer to page 19.

Coupe

 In vehicles without an alarm system* or Comfort Access*, only the driver's door can be locked via the door lock. ◀

To lock all doors, the fuel filler flap and the trunk lid at once:

1. With the doors closed, lock the vehicle using the button for the central locking system in the interior, refer to page 23.
2. Unlock and open the driver's or front passenger door, refer to page 24.
3. Lock the vehicle.
 - ▶ Lock the driver's door using the integrated key in the door lock, or
 - ▶ press down the lock button of the front passenger door and close the door from the outside.

Convenient operation

Coupe: if the vehicle is equipped with an alarm system* or Comfort Access*, you can also operate the windows and the glass roof* via the door lock.

Convertible: you can operate the windows and the retractable hardtop via the door lock.

Hold the key in the position for unlocking or locking.

 During each closing procedure, and when opening the retractable hardtop, watch the process and ensure that no one becomes

trapped. Releasing the key stops the operation. ◀

Manual operation

In the event of an electrical malfunction, you can lock and unlock the driver's door by turning the integrated key to the corresponding limit positions in the door lock.

Opening and closing: From inside

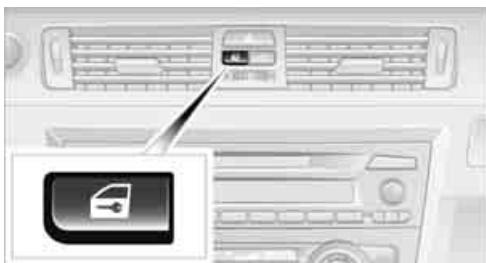

This button serves to unlock or lock doors and the trunk lid, but does not activate the anti-theft system. The fuel filler flap remains unlocked.

Automatic locking

You can also set the situations in which the car locks:

For operating principle, refer to page 74.

1. Switch on the ignition, refer to page 50.
2. Lightly push button 1 in the turn indicator lever up or down repeatedly until the symbol appears in the display accompanied by the word "SET".



3. Press button 2.

- Lightly push button **1** in the turn indicator lever down repeatedly until the symbol appears in the display.



- Press button **2**.
- Use button **1** to select:

- ▷ **on**
The central locking system automatically locks the vehicle after some time if no door has been opened.
 - ▷ **on**
The central locking system automatically locks the vehicle as soon as you drive off.
 - ▷ **→**
The central locking system automatically locks the vehicle after some time if no door has been opened, or as soon as you drive off.
 - ▷ **off**
The central locking system remains unlocked.
- Press button **2**.
The setting is stored for the remote control currently in use.

Unlocking and opening doors

- ▷ Either unlock the doors together using the button for the central locking system and then pull the door handle above the armrest or
- ▷ pull on the door handle of each door twice: the first time unlocks the door, the second time opens it.

Locking

- ▷ Use the central locking button to lock all of the doors simultaneously, or
- ▷ press down the safety lock button of a door. To prevent you from being locked out, the open driver's door cannot be locked using the lock button.

Persons or animals in a parked vehicle could lock the doors from the inside. You should therefore take the remote control with you when you leave the vehicle so that the latter can be opened from outside. ◀

Trunk lid

In order to avoid damage, make sure there is sufficient clearance before opening the trunk lid. ◀

Opening from inside



Press the button: the trunk lid opens unless it has been locked.

Opening from outside



Press the button, see arrow, or the  button on the remote control for a longer period. The trunk lid will open slightly. It can now be swung upwards.

 In the event of a malfunction, please contact your BMW center or a workshop that works according to BMW repair procedures with correspondingly trained personnel. ◀

Coupe: locking or unlocking separately

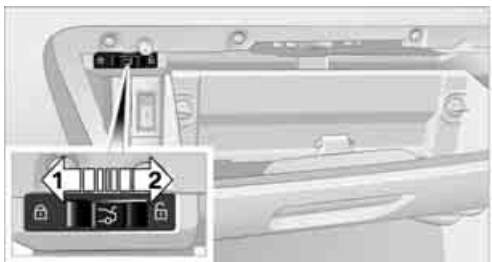

The switch is located in the glove compartment.

- 1 Locking the trunk lid
- 2 Unlocking the trunk lid

Locking separately

Push the switch in the direction of arrow **1**. The trunk lid is locked and cannot be unlocked using the central locking system.

If you give the remote control without the integrated key to someone else while the glove compartment is locked, the trunk lid cannot be opened. This is an advantage when valet parking, for example. Locking the glove compartment, refer to page [107](#).

Unlocking separately

Push the switch in the direction of arrow **2**.

Emergency release



Pull the lever in the cargo area. The trunk lid is unlocked.

Closing

The handle recesses on the interior trim of the trunk lid make it easier to pull down.

 Make sure that the closing path of the trunk lid is clear; otherwise, injuries may result. ◀

Coupe



Convertible

 To close the trunk lid, press it down lightly. The lid is closed automatically. ◀



Alarm system*

The concept

The vehicle alarm system responds:

- ▷ When a door, the hood or the trunk lid is opened
- ▷ To movements inside the vehicle: Interior motion sensor, refer to page 27
- ▷ When the car's inclination changes, for instance if an attempt is made to jack it up and steal the wheels or to raise it prior to towing away
- ▷ When there has been an interruption of power supply from the battery

The alarm system signals unauthorized entry attempts for a short time by means of:

- ▷ An acoustic alarm
- ▷ Switching on the hazard warning flashers
- ▷ Flashing the high beams

Arming and disarming

When you lock or unlock the vehicle, either with the remote control or at the door lock, the alarm system is armed or disarmed at the same time.

You can open the trunk lid even when the alarm system is armed, by pressing the  button on the remote control, refer to page 21. The lid is locked and monitored again as soon as you close it.

Panic mode*

You can trigger the alarm system if you find yourself in a dangerous situation:

Press the  button for at least three seconds.

To switch off the alarm: press any button.

Switching off an alarm

- ▷ Unlock the car with the remote control, refer to page 19.
- ▷ Insert the remote control all the way into the ignition lock.

Indicator lamp displays



- ▷ The indicator lamp under the inside rear-view mirror flashes continuously: the system is armed.
- ▷ The indicator lamp flashes after locking: doors, hood or trunk lid are not properly closed. Even if you do not close the alerted area, the system begins to monitor the remaining areas, and the indicator lamp flashes continuously after approx. 10 seconds. The interior motion sensor and the tilt alarm sensor are not activated.
- ▷ The indicator lamp goes out after unlocking: your vehicle has not been disturbed while you were away.
- ▷ If the indicator lamp flashes after unlocking until the remote control is inserted in the ignition, but for no longer than approx. 5 minutes: your vehicle has been disturbed while you were away.

Tilt alarm sensor

The tilt of the vehicle is monitored. The alarm system reacts, e.g. to attempts to steal a wheel or tow the vehicle.

Interior motion sensor

Coupe

In order for the interior motion sensor to function properly, the windows and glass roof must be completely closed*.

Convertible

The interior of the car is monitored up to the height of the seat cushions. Thus the alarm system is activated together with the interior motion sensor even if the hardtop is open. The alarm can be triggered unintentionally by falling objects such as leaves, refer to Avoiding unintentional alarms.

Avoiding unintentional alarms

The tilt alarm sensor and interior motion sensor may be switched off at the same time. This prevents unintentional alarms, e.g. in the following situations:

- ▷ In duplex garages
- ▷ During transport on car-carrying trains, boats/ships or on a trailer
- ▷ When animals are to remain in the vehicle

Switching off tilt alarm sensor and interior motion sensor

Press the  LOCK button on the remote control again as soon as the vehicle is locked.

The indicator lamp lights up briefly and then flashes continuously. The tilt alarm sensor and the interior motion sensor are switched off until the next time the vehicle is unlocked and subsequently locked again.

Comfort Access*

Comfort Access enables you to enter your vehicle without needing to hold the remote control in your hand. All you need to do is wear the remote control close to your body, e.g. in your jacket pocket. The vehicle detects the corresponding remote control within the immediate vicinity or in the passenger compartment.

Comfort Access supports the following functions:

- ▷ Unlocking/locking the vehicle
- ▷ Unlocking the trunk lid separately
- ▷ Engine starting
- ▷ Convenient closing

Functional requirement

- ▷ The vehicle or the trunk lid can only be locked when the vehicle detects that the remote control currently in use is outside of the vehicle.
- ▷ The vehicle cannot be locked or unlocked again until after approx. 2 seconds.
- ▷ The engine can only be started when the vehicle detects that the remote control currently in use is inside the vehicle.

Comparison to the standard remote control

In general, there is no difference between using Comfort Access or pressing the buttons on the remote control to carry out the functions mentioned above. You should therefore first familiarize yourself with the instructions on opening and closing starting on page 18.

Special features regarding the use of Comfort Access are described below.

-  If you notice a brief delay while opening or closing windows, the glass roof or retractable hardtop, the system is checking whether a remote control is inside the vehicle. Please repeat the opening or closing procedure, if necessary. ◀

Unlocking

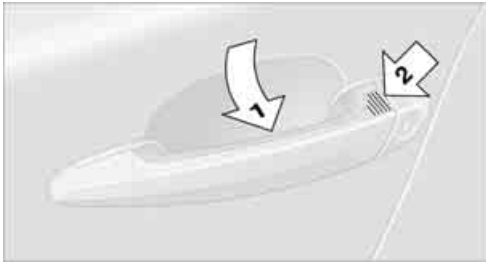

Grasp the handle on the driver's or front passenger door completely, arrow 1. This corresponds to pressing the  button.

Locking

Touch the surface, arrow 2, with your finger for approx. 1 second. This corresponds to pressing the  LOCK button.

 To preserve the battery, please make sure that the ignition and all electrical consumers are switched off before locking the vehicle. ◀

Coupe: convenient closing

For Convenient closing, keep your finger on the surface, arrow 2.

Convertible: window and convertible top operation

With the ignition at radio readiness or beyond, you can open and close the windows and the convertible top when a remote control is located inside the vehicle.

Unlocking the trunk lid separately

Press the button on the outside of the trunk lid. This corresponds to pressing the  button.

 If the vehicle detects that a remote control has been accidentally left inside the locked vehicle's cargo area after the trunk lid is closed, the lid will reopen. The hazard warning flashers flash and an acoustic signal* sounds. ◀

Switching on radio readiness

Radio readiness is switched on by pressing the start/stop button, refer to page 50.

 Do not depress the brake or the clutch; otherwise, the engine will start. ◀

Starting the engine

You can start the engine or switch on the ignition when a remote control is inside the vehicle. It is not necessary to insert a remote control into the ignition lock, refer to page 50.

Switching off the engine in cars with automatic transmission

The engine can only be switched off when the selector lever is in position P, refer to page 52. To switch the engine off when the selector lever is in position N, the remote control must be in the ignition lock.

Malfunction

Comfort Access may malfunction due to local radio waves. If this happens, open or close the vehicle via the buttons on the remote control or using the integrated key. To start the engine afterward, insert the remote control into the ignition lock.

Warning lamps



The warning lamp in the instrument cluster lights up when you attempt to start the engine: the engine cannot be started. The remote control is not inside the vehicle or is malfunctioning.

Take the remote control with you inside the vehicle or have it checked. If necessary, insert another remote control into the ignition lock.



The warning lamp in the instrument cluster lights up while the engine is running: the remote control is no longer inside the vehicle. After the engine is switched off, the engine can only be restarted within approx. 10 seconds.



The indicator lamp in the instrument cluster comes on: replace the battery in the remote control.

Replacing the battery

The remote control for Comfort Access contains a battery that will need to be replaced from time to time.

1. Take the integrated key out of the remote control, refer to page 18.



2. Remove the cover.
3. Insert the new battery with the plus side facing up.
4. Press the cover on to close.

 Take the old battery to a battery collection point or to your BMW center. ◀

Windows

 To prevent injuries, watch the windows while closing them.

Take the remote control with you when you leave the car; otherwise, children could operate the electric windows and possibly injure themselves. ◀

Coupe: opening, closing

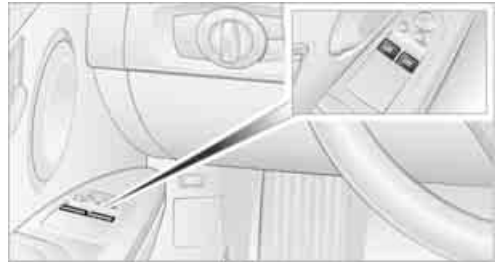

- ▷ Press the switch to the resistance point: The window opens as long as you press the switch.
- ▷ Press the switch beyond the resistance point: The window opens automatically. Press the switch again to stop the opening movement.

You can close the windows in the same manner by pulling the switch.

Convertible: opening, closing

Individually



- ▷ Press the switch to the resistance point: The window opens as long as you press the switch.
- ▷ Press the switch beyond the resistance point: The window opens automatically. Press the switch again to stop the opening movement.

You can close the windows in the same manner by pulling the switch. The rear windows do not close automatically.

Jointly

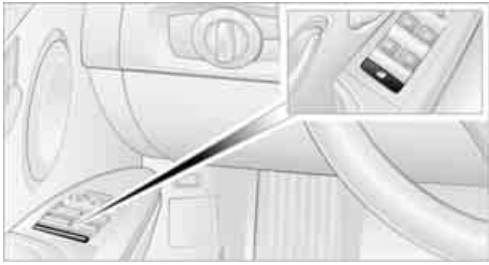

- ▷ Press the switch to the resistance point: All windows open as long as you press the switch.
- ▷ Press the switch beyond the resistance point: All windows open automatically. Press the switch again to stop the opening movement.
- ▷ Pull the switch: All windows close as long as you pull the switch.

After switching off the ignition

When the remote control is removed or the ignition is switched off, you can still operate the windows for approx. 1 minute as long as no door is opened.

Convenient operation

For information on Convenient operation via the remote control or the door lock, refer to page 19 or 23. For information on Convenient closing with Comfort Access, refer to Locking on page 20.

Pinch protection system

If the closing force exceeds a specific value as a window closes, the closing action is interrupted and the window reopens slightly.

- ⚠ Despite the pinch protection system check and clear the window's travel path prior to closing it; otherwise, the safety system might fail to detect certain kinds of obstructions, such as thin objects, and the window would continue closing. Do not install any accessories that might inter-

fere with window movement. Otherwise, the pinch protection system could be impaired. Convertible: the rear windows are not equipped with pinch protection. Therefore, watch them closely when closing to avoid personal injury. ◀

Closing without pinch protection

If there is an external danger, or if ice on the windows, etc., prevents you from closing the windows normally, proceed as follows:

1. Pull the switch past the resistance point and hold it there. Pinch protection is limited and the window reopens slightly if the closing force exceeds a certain value.
2. Pull the switch again past the resistance point within approx. 4 seconds and hold it there. The window closes without pinch protection.

Coupe: glass roof*, electric

- ⚠ To prevent injuries, watch the glass roof while closing it.

Take the remote control with you when you leave the car; otherwise, children could operate the roof and possibly injure themselves. ◀



Raising

Press the switch.

- ▷ The closed glass roof is raised and the sliding visor opens slightly.

Opening, closing

- ▷ Press the switch backwards to the resistance point.
The glass roof and the sliding visor open together as long as you hold the switch in this position.
- ▷ Press the switch backwards past the resistance point.
The glass roof and the sliding visor open automatically. Briefly press the switch again to stop the opening movement.

You can close the glass roof in a similar manner by pressing the switch forwards. The sliding visor remains open and can be closed by hand. For information on Convenient operation via the remote control or door lock, refer to page 19 or 23.

After switching off the ignition

When the remote control is removed or the ignition is switched off, you can still operate the roof for approx. 1 minute as long as no door has been opened.

Pinch protection system

If the glass roof encounters an obstruction during closing from approximately the middle of the opening in the roof, or during closing from the raised position, the closing movement is interrupted and the glass roof is opened again slightly.

 Despite the pinch protection system check and clear the roof's travel path prior to closing it; otherwise, the safety system might fail to detect certain kinds of obstructions, such as very thin objects, and the roof would continue closing. ◀

Closing without pinch protection

If there is an external danger, press the switch forward past the resistance point. The roof closes without pinch protection.

Following interruptions in electrical power supply

After a power failure, there is a possibility that the glass roof can only be raised. The system must be initialized. BMW recommends having this work done by your BMW center.

Closing manually*

In the event of an electrical malfunction, you can move the glass roof manually:

1. Unclip the front of the cover of the interior lamps using the screwdriver from the onboard vehicle tool kit, refer to page 154.



2. Insert the screwdriver into the openings on each side to press the clips.



3. Remove the control unit.
4. Unplug the motor. Considerably less effort will be required for manual operation.

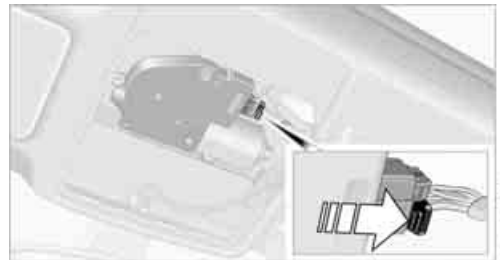

5. Insert the Allen wrench* supplied with the onboard vehicle tool kit, refer to page 154, into the opening provided. Move the glass roof in the desired direction.

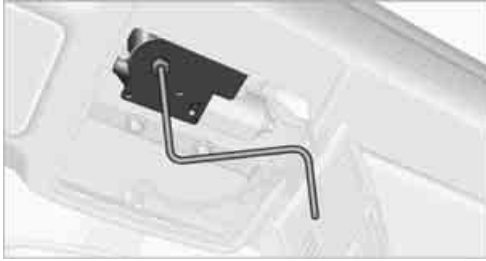

6. Reinstall the control unit and reattach the lamp cover.

Convertible: retractable hardtop

The retractable hardtop combines reliable weather protection with simple and convenient operation.

The following tips will enhance your driving pleasure in your Convertible:

- ▷ It is advisable that you close the retractable hardtop when you park the vehicle. Not only does the closed hardtop protect the vehicle interior against unanticipated weather damage, it also offers theft protection. However, even when the hardtop is closed, valuables should only be stored in the locked cargo area.
- ▷ Do not attach roof rack systems to the retractable hardtop, and in particular do not attach magnetic racks.
- ▷ Do not attach rack systems to the trunk lid, and in particular do not attach magnetic racks.
- ▷ When the retractable hardtop is operated, the trunk lid swings back and up. Before operating the retractable hardtop, ensure that there is enough clearance, e.g. when parked in front of a wall.

- ▷ If you open the hardtop while it is wet, e.g. after driving in the rain, water may drip into the cargo area. If necessary, remove items from the cargo area beforehand to avoid water stains or soiling.

 Do not place any objects on the retractable hardtop or on the trunk lid; otherwise, they could fall during movements of the retractable hardtop and cause damage or injury. Never move the retractable hardtop when the rollover protection system is in the activated position.

Driving when the hardtop is not fully opened or closed may result in damage or injury. Do not reach into the mechanism during the opening or closing procedure. Keep children away from the swiveling area of the retractable hardtop. ◀

 The retractable hardtop cannot be moved at temperatures below +14 °F / -10 °C. ◀

 The retractable hardtop can only be opened and closed when the vehicle is stationary. To avoid causing damage, do not drive off until the hardtop has stopped moving. ◀

Before opening and closing

- ▷ Comply with the safety precautions described above.
- ▷ Ensure that the cargo area partition is folded down and engaged on both sides, refer to page 111; otherwise, it will not be possible to open the retractable hardtop.
- ▷ Do not place any objects next to or on the cargo area partition and close the storage compartment on the left side of the cargo area.
- ▷ Do not exceed the maximum loading height under the cargo area partition; refer to the label in the cargo area showing a line indicating the maximum height.
- ▷ Ensure that the trunk lid is closed.
- ▷ The vehicle should be parked on fairly level ground. Excessive angle is indicated by a lamp.

Opening and closing

When the vehicle is stationary and at radio readiness or beyond, refer to page 50:

- ▶ If possible, conserve the battery by only operating the retractable hardtop when the engine is running.

Before closing the retractable hardtop, remove all foreign objects from the windshield frame as these could prevent the hardtop from closing properly. ◀



- 1 Push button: open the retractable hardtop. Pull button: close the retractable hardtop.

2 LEDs

- ▶ The side windows move down when the switch for hardtop operation is pulled or pushed. ◀

LEDs

- ▶ While the hardtop is being operated, the left LED lights up green. It goes out as soon as the top is fully opened or closed.
- ▶ If the right-hand LED flashes red when you release the switch, the opening or closing action has not yet finished.
- ▶ If the right LED lights up red when the switch is pressed, the cargo area partition is folded up, the trunk lid is not closed, the vehicle is standing on a strong incline or there is a malfunction. The retractable hardtop cannot be moved.

Interruption

The automatic sequence of movements is interrupted if the switch for hardtop operation is released. The sequence can be continued in the desired direction by pushing or pulling the switch.

- ⚠ A hardtop that is not fully opened or closed is a safety hazard.

Do not interrupt and resume the closing procedure several times in close succession as this could damage the mechanism. ◀

- ▶ If the hardtop is not fully opened or closed, the trunk lid cannot be opened and the windows cannot be moved. ◀

Convenient operation with remote control or via door lock

Refer to pages 20 and 23.

Wind deflector*

The wind deflector keeps air movements in the passenger compartment to a minimum when the hardtop is open and provides an even more comfortable ride, particularly at high speeds.

Installation

The wind deflector is stored in a protective cover in the cargo area. Brief instructions for operation can be found on the protective cover.

1. Remove the wind deflector from the protective cover and unfold it, arrows 1.

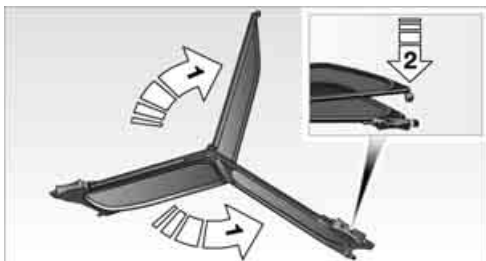

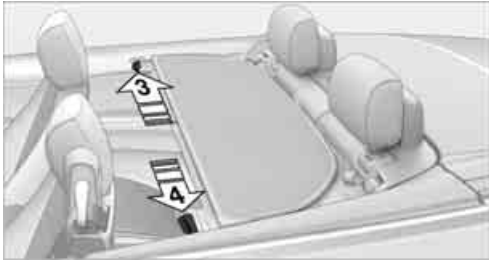

- Press together the top and bottom parts of the wind deflector until the catch engages, arrow 2.



- Push the fastening pin, arrow 3, into the opening provided on the right side of the vehicle until it snaps into place. Remove the protective caps beforehand, if necessary.
- Push the fastening pin, arrow 4, into the opening provided on the left side of the vehicle until it snaps into place.



- Turn the rotary handle in the direction of arrow 5 as far as the first stop to insert the right fastening pin into the holders.
- Turn the rotary handle in the direction of arrow 6 as far as the  symbol to insert the left fastening pin into the holders.
- Fold up the top section of the wind deflector.

 With the wind deflector installed: do not recline the front-seat backrests too far if the seat is to be slid all the way back, as this would damage the wind deflector. ◀

 Only turn the rotary handle within the range between the two symbols; otherwise, the cable system inside the wind deflector could be damaged. ◀

Removing the wind deflector

Proceed in the reverse order as used for installation.

Protective caps are provided in the vehicle for the holders of the wind deflector.

Folding

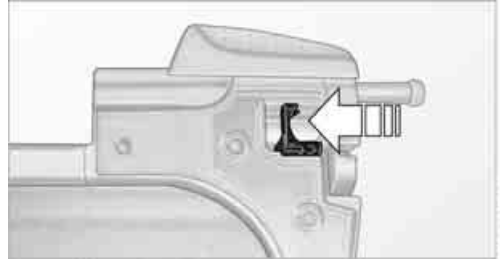



Slide the red release lever towards the middle of the wind deflector and push the two halves apart.

Loading function

Cargo can still be loaded on the rear seat of the vehicle even if the wind deflector has been installed.

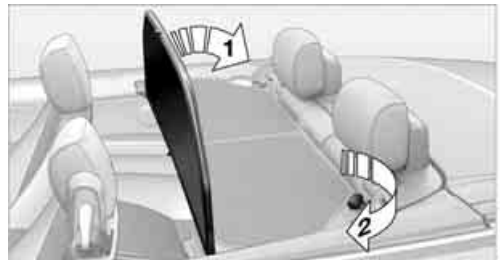
- Lower all windows.
- Fold down the top section of the wind deflector, arrow 1.



3. Turn the rotary handle to position , arrow **2**.



Fold both sections of the wind deflector forward and rest them against the front seats, arrow **3**.

To protect the seat cushions or to use the bag holders, you can fold the rear backrest down, refer to page [112](#).

Adjustments

Sitting safely

The ideal sitting position can make a vital contribution to relaxed, fatigue-free driving. In conjunction with the safety belts, the head restraints and the airbags, the seated position has a major influence on your safety in the event of an accident. To ensure that the safety systems operate with optimal efficiency, we strongly urge you to observe the instructions contained in the following section.

For additional information on transporting children safely, refer to page 47.

Airbags

 Always maintain an adequate distance between yourself and the airbags. Always grip the steering wheel on the rim, with your hands in the 3 o'clock and 9 o'clock positions, to minimize the risk of injury to the hands or arms in the event of the airbag being triggered off.

No one and nothing should come between the airbags and the seat occupant.

Do not use the cover of the front airbag on the front passenger side as a storage area. Make sure that the front passenger is sitting correctly, e.g. not resting feet or legs on the dashboard; otherwise, leg injuries can occur if the front airbag deploys.

Make sure that passengers keep their heads away from the side airbag and do not lean against the cover of the head airbag; otherwise, serious injuries can result if the airbag deploys. ◀

Even if you follow all the instructions, injuries resulting from contact with airbags cannot be fully excluded, depending on the circumstances. The ignition and inflation noise may provoke a mild hearing loss in extremely sensitive individuals. This effect is usually only temporary.

For airbag locations and additional information on airbags, refer to page 88.

Head restraint

A correctly adjusted head restraint reduces the risk of neck injury in the event of an accident.

 Adjust the head restraint in such a way that its center is at approx. ear level. Otherwise, there is an increased risk of injury in the event of an accident. ◀

Head restraints, refer to page 39.

Safety belt

Before every drive, make sure that all occupants wear their safety belts. Airbags complement the safety belt as an additional safety device, but they do not represent a substitute.

Your vehicle has four seats, each of which is equipped with a safety belt.

 Never allow more than one person to wear a single safety belt. Never allow infants or small children to ride in a passenger's lap. Make sure that the belt in the lap area sits low across the hips and does not press against the abdomen.

The safety belt must not rest against the throat, run across sharp edges, pass over hard or fragile objects or be pinched. Fasten the safety belt so that it sits as snugly as possible against the lap and shoulder without being twisted. Otherwise, the belt could slide over your hips and injure your abdomen in the event of a frontal collision.

Avoid wearing bulky clothing and regularly pull the belt in the upper-body area taut; otherwise, its restraining effect could be impaired. ◀

Safety belts, refer to page 43.

Seats

Note before adjusting

⚠ Never attempt to adjust your seat while the vehicle is moving. The seat could respond with unexpected movement, and the ensuing loss of vehicle control could lead to an accident.

On the front passenger seat as well, do not incline the backrest too far to the rear while the vehicle is being driven; otherwise, there is a danger in the event of an accident of sliding under the safety belt, eliminating the protection normally provided by the belt. ◀

Comply with the instructions on head restraint height on page 39, and on damaged safety belts on page 43.

Manual adjustment

⚠ Observe the adjustment instructions on page 37 to ensure the best possible personal protection. ◀

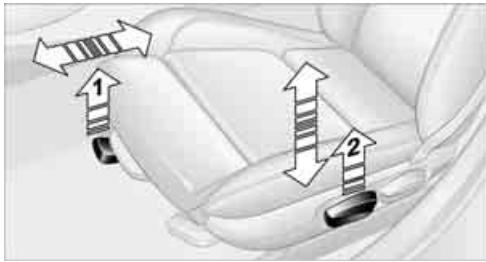

Longitudinal direction

Pull lever 1 and slide the seat to the desired position. After releasing the lever, move the seat gently forward or back to make sure it engages properly.

Height

Pull lever 2 and apply your weight to the seat or lift it off, as necessary.

Backrest

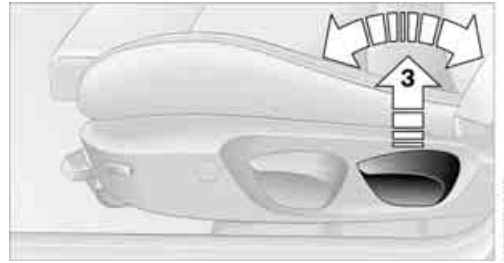

Pull lever 3 and apply your weight to the backrest or lift it off, as necessary.

Tilt*

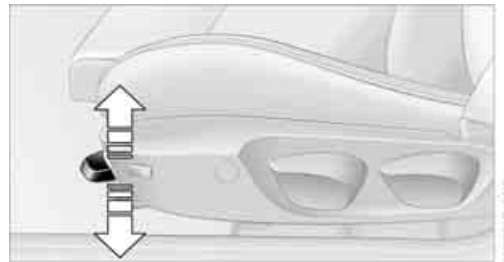

Pull the lever and apply your weight to the seat or lift it off, as necessary.

Thigh support*

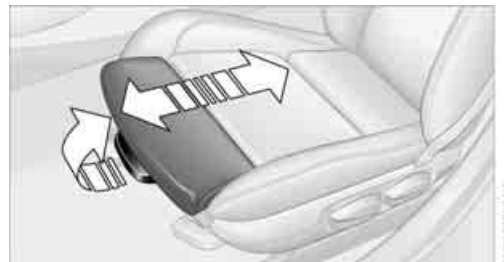

Pull the lever and move the thigh support forward or back.

Electrical adjustment

 Observe the adjustment instructions on page 37 to ensure the best possible personal protection. ◀

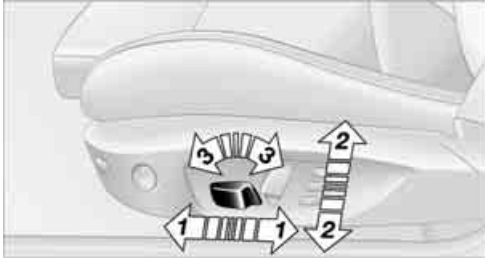

- 1 Longitudinal direction
- 2 Height
- 3 Angle

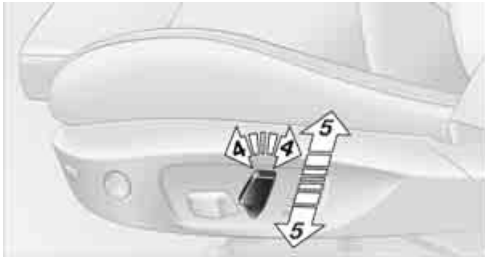

- 4 Backrest
- 5 Convertible: head restraints

Coupe: the head restraints are adjusted manually, refer to Head restraints below.

Lumbar support*



You can also adjust the contour of the backrest to obtain additional support in the lumbar region.

The upper hips and spinal column receive supplementary support to help you maintain a relaxed, upright sitting position.

- ▷ Increase or decrease curvature: press the switch at the front or rear, respectively.
- ▷ Shift curvature up or down: press the switch at the top or bottom, respectively.

Backrest width*



You can change the width of the backrest to suit your individual preferences by adjusting the lateral-support pads.

Press the front or rear end of the switch. Backrest width decreases or increases accordingly.

Longitudinal adjustment from outside/behind*

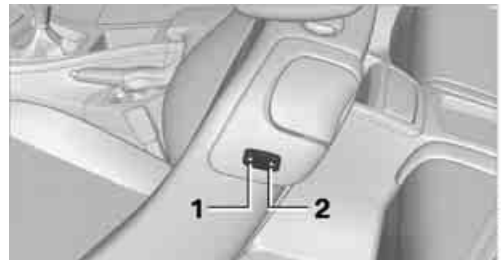

To move the front seats forward or backward from outside or from one of the rear seats: with the door open, press the front end 1 or rear end 2 of the switch.

Head restraints

Correctly adjusted head restraint

A correctly adjusted head restraint reduces the risk of neck injury in the event of an accident.

 Adjust the head restraint in such a way that its center is at approx. ear level. Otherwise, there is an increased risk of injury in the event of an accident. Only remove a head restraint if no one will be sitting on the seat in question. Reinstall the head restraint before transporting anyone on that seat. Otherwise, the passenger will be without protection from the head restraint. ◀

Height

Adjust the head restraint so that its center is approximately at ear level.

Distance

Adjust the distance so that the head restraint is as close as possible to the back of the head.

Front active head restraints

In a rear collision of a sufficient strength, the active head restraint reduces the distance to the head.

 Do not use seat or head restraint covers that could impair the function of the active head restraint. Otherwise, the protective function of the active head restraint will not be ensured and its full potential in reducing the risk of injury in the event of a rear collision may not be realized.

In the event of malfunctions, deactivation or triggering of the active head restraints, have the testing, repair and removal executed only by a BMW center or a workshop that works according to repair procedures of BMW with correspondingly trained personnel and that has the required explosives licenses. Unprofessional attempts to work on the system could lead to failure in an emergency or to undesired airbag activation, either of which could result in personal injury. ◀

 For technical reasons, the head restraint cannot be removed. ◀

Coupe: front seats

Height adjustment

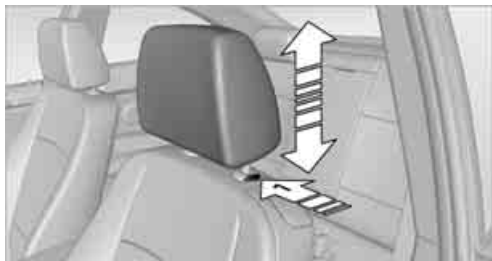

- ▷ To raise: pull up.
- ▷ To lower: press the button, arrow 1, and slide the head restraint down.

Convertible: front seats

Height adjustment

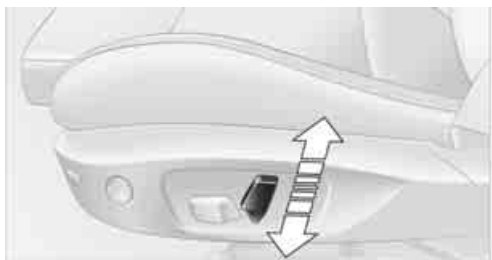

- ▷ To raise: press the button upward.
- ▷ To lower: press the button downward.

Adjusting the distance to the back of the head

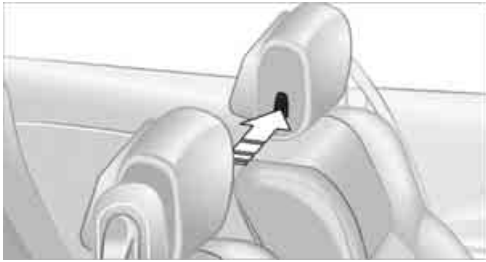

- ▷ Forward: pull up.
- ▷ Back: press the button and push the head cushion toward the rear.

⚠ Do not insert objects behind the head cushion; otherwise, the head restraint may not function properly. ◀

Coupe: rear seats

Height adjustment

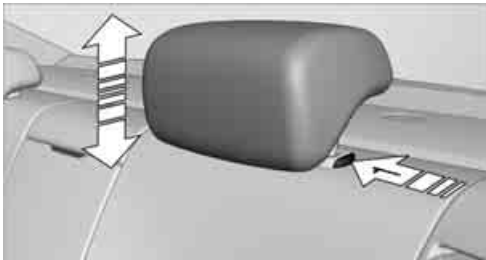

- ▷ To raise: pull up.
- ▷ To lower: press the button, arrow **1**, and slide the head restraint down.

Removing

1. Pull up as far as it will go.
2. Press the button, arrow **1**, tilt the rear seat backrest slightly forward and pull the head restraint all the way out.

▷ Only remove the head restraints if no passengers will be sitting in the rear. Reinstall head restraints before transporting passengers in the rear. ◀

Entering the rear seats

Coupe: seat with manual longitudinal adjustment

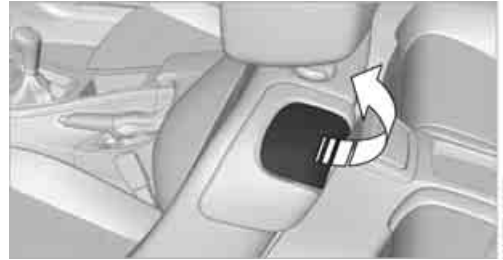

Easy entry

The easy entry feature includes a memory function for the longitudinal adjustment and backrest angle.

1. Pull the lever and swing the backrest forward.
2. Push the seat forward.

Previous position

Push the seat backward and swing the backrest back.

⚠ When pushing the seat into its rearmost position, make sure that no one is injured and that no objects are damaged. Before driving off, engage both seats and backrests so that they are locked in place. Otherwise, there is a risk of an accident due to unexpected movement. ◀

Seat with electrical longitudinal adjustment

Coupe

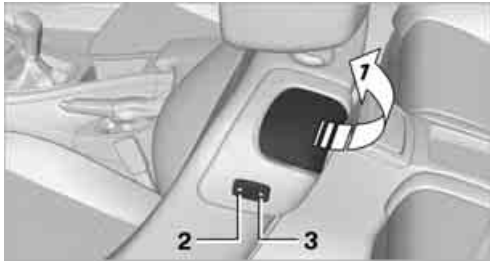

Convertible



Seat backrest warning lamp:
Comes on when a seat backrest is not engaged.

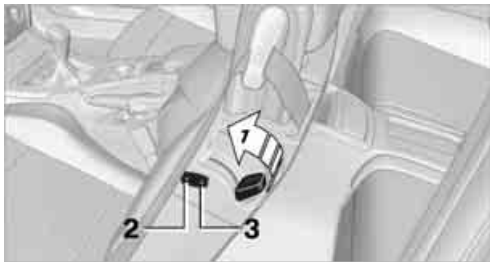

Easy entry

The easy entry feature includes a memory function for the longitudinal adjustment and backrest angle.

1. Pull lever **1** and swing the backrest forward.
2. Press the front end **2** of the switch until the seat has moved into the desired position.

Previous position

Press the rear end **3** of the switch until the seat automatically stops in its previous position, and fold the backrest back. If you release the switch before the previous seat position is reached, the seat will stop at its current position.



When sliding the seat backward, make sure no one is injured and no objects are damaged.

Before driving off, engage both seats and backrests so that they are locked in place. Otherwise, there is a risk of an accident due to unexpected movement. ◀

Heated seats*



Depending on the vehicle's equipment, press one of the buttons labeled **1** or **2** here.

Press the button once per temperature level. Three LEDs indicate the highest temperature.

To switch off:
Press button longer.

If you continue driving within approx. the next 15 minutes, the seat heating is automatically activated at the previously set temperature.

The temperature is lowered or the heating is switched off entirely to save on battery power. The LEDs stay lit.

Seat and mirror memory*

You can store and call up two different combinations of driver's seat and exterior mirror positions.

Settings for the backrest width and lumbar support are not stored in memory.

Storing

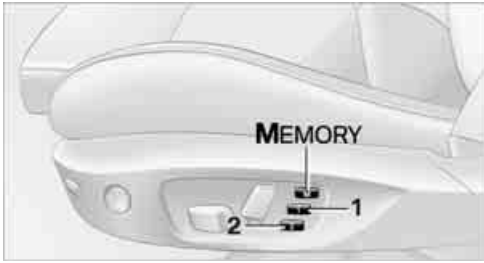

1. Switch on radio readiness or the ignition, refer to page 50.
2. Adjust the seat and exterior mirrors to the desired positions.
3. Press the **M** button.
The LED in the button lights up.
4. Press the desired memory button **1** or **2**: the LED goes out.

The driver's seat and exterior mirror positions are stored for the remote control currently in use.

Call-up

! Do not call up the memory while you are driving; otherwise, unexpected seat movement could result in an accident. ◀

Comfort function

1. Unlock and open the driver's door or switch on radio readiness, refer to page 50.
2. Briefly press the desired memory button **1** or **2**.

The adjusting procedure is halted immediately when you touch a seat adjustment switch or one of the memory buttons.

Safety feature

1. Close the driver's door and switch the ignition on or off, refer to page 50.
2. Press the desired memory button **1** or **2** and keep it pressed until the adjustment process has been completed.

If the **M** button was pressed accidentally: Press the button again; the LED goes out.

Call-up with the remote control

The driver's seat position last set is stored for the remote control currently in use.

You can select whether or not the seat is reset to that position automatically.

! When this Personal Profile function is used, first make sure that the footwell behind the driver's seat is free of obstacles. Failure to do so could cause injury to persons or damage to objects as a result of a rearward movement of the seat. ◀

The adjusting procedure is halted immediately when you touch a seat adjustment switch or one of the memory buttons.

Activating/deactivating automatic call-up

For operating principle refer to page 74.



1. Lightly push button **1** in the turn indicator lever up or down repeatedly until the symbol appears in the display accompanied by the word "SET".



2. Press button **2**.
3. Lightly push button **1** in the turn indicator lever down repeatedly until the symbol appears in the display.



4. Press button **2**.

5. Use button **1** to select:
 - ▷  Call-up when the vehicle is unlocked.
 - ▷  Call-up when the driver's door is opened.
 - ▷ **off**
Switch off automatic function.
6. Press button **2**.
The setting is stored.

Safety belts

 Observe the adjustment instructions on page 37 to ensure the best possible personal protection. ◀

Before every drive, make sure that all occupants wear their safety belts. Airbags complement the safety belt as an additional safety device, but they do not represent a substitute.



Closing

Make sure you hear the latch plate engage in the belt buckle.

The upper belt anchor is suitable for adults of any stature as long as the seat is adjusted properly, refer to page 37.

Opening

1. Grasp the belt firmly.
2. Press the red button in the buckle.
3. Guide the belt into its reel.

"Fasten safety belts" reminder for driver's and front passenger seat



The indicator lamps light up and an acoustic signal sounds. Check whether the safety belt has been fastened correctly.

The "Fasten safety belts" reminder is issued as long as the driver's safety belt has not been fastened. The "Fasten safety belts" reminder is also activated at road speeds above approx. 5 mph or 8 km/h if the front passenger safety belt is not fastened, if objects are placed on the front passenger seat, or if driver or front passenger unfasten their safety belts.

Damage to safety belts

 If the safety belts are damaged or stressed in an accident: have the belt system, including any belt tensioners or child restraint systems, replaced and the belt anchors checked. Have this work done only by your BMW center or at a workshop that works according to BMW repair procedures with correspondingly trained personnel. Otherwise, it is not guaranteed that the safety devices will function properly. ◀

Coupe: belt hand-over

The concept

The belt hand-over makes it easier for you to fasten your safety belt. When you close the door and switch on radio readiness or the ignition, the belt hand-over extends automatically and presents the in a position that is convenient for fastening it around you. After you have fastened your safety belt, the belt hand-over retracts to its original position.

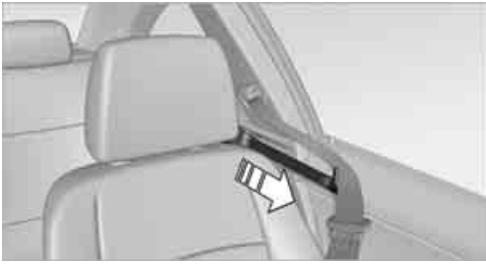

Even if you have not yet fastened your safety belt, the belt hand-over will retract if you:

- ▷ Wait for more than approx. one minute
- ▷ Open the corresponding door
- ▷ Start driving.

Closing the respective door reactivates the belt hand-over if the ignition or radio readiness is on.

Front passenger seat

The belt hand-over will extend only if the seat is occupied and after the front passenger door is closed.

Pinch protection system

If the belt hand-over encounters resistance on moving in or out, it moves back slightly in the opposite direction and stops in this position. To reactivate the belt hand-over: open and close the door or switch the ignition off and on.

⚠ Although there is a pinch protection system, always check that the maneuvering area of the belt hand-over is clear. Otherwise it cannot be ensured that the system will stop moving in certain extreme situations. ◀

Mirrors

Exterior mirrors

⚠ The front passenger's mirror is more convex than the driver's mirror. The objects seen in the mirror are closer than they appear. Do not gauge your distance from traffic behind you on the basis of what you see in the mirror; otherwise, there is an increased risk of an accident. ◀

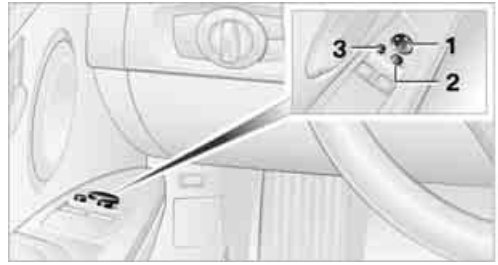

- 1 Adjustments
- 2 Switching to the other mirror or automatic curb monitor*
- 3 Folding mirrors in and out*

The setting for the exterior mirrors is stored for the remote control currently in use*. The stored position is called up automatically when the vehicle is unlocked.

Manual adjustment

The mirrors can also be adjusted manually: press the edge of the glass.

Folding mirrors in and out*

At driving speeds up to approx. 12 mph/20 km/h, you can fold the mirrors in and out by pressing button **3**. This can be beneficial in narrow streets, for example, or for moving mirrors that were folded in by hand back out into their correct positions. Mirrors that were folded in are folded out automatically at a speed of approx. 25 mph/40 km/h.

⚠ Before entering an automatic car wash, fold in the exterior mirrors manually or with button **3** to prevent them from being damaged, depending on the width of the vehicle. ◀

Automatic heating

Depending on the outside temperature, both exterior mirrors are heated automatically when the engine is running or the ignition is switched on.

Passenger side mirror tilt function – automatic curb monitor*

Activating

1. Push the switch to the position for the driver's side mirror, arrow 1.

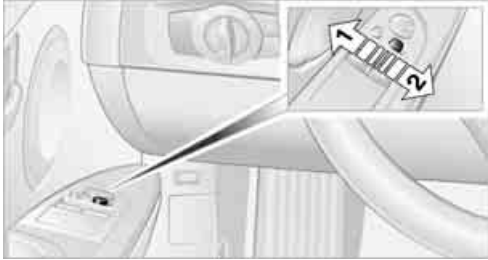

2. Shift into reverse or engage the selector lever- or transmission position R. The glass of the mirror on the passenger side tilts slightly down. This allows the driver to see the area immediately adjacent to the vehicle, e.g. a curb, when backing into a parking space.

Deactivating

Push the switch to the position for the passenger side mirror, arrow 2.

Interior rearview mirror



Turn the knob to reduce glare from the headlamps of cars behind you when driving at night.

Interior and exterior mirrors, automatic dimming feature*

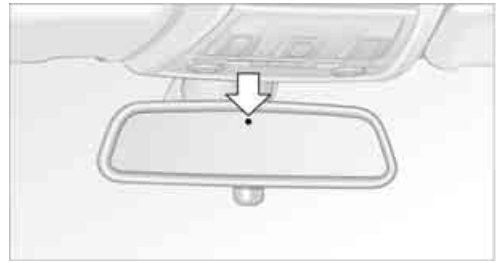

The automatic dimming feature of the interior and exterior mirrors* is controlled by two photo cells in the interior rearview mirror. One photo cell is in the mirror frame, see arrow; the other is on the back of the mirror.

In order to ensure that the system functions correctly, keep the photo cells clean, do not cover the area between the interior rearview mirror and windshield, and do not affix adhesive labels or stickers of any kind to the windshield directly in front of the mirror.

Steering wheel

Adjustments

 Do not adjust the steering wheel position while the car is in motion; otherwise, there is a risk of an accident due to unexpected movement. ◀

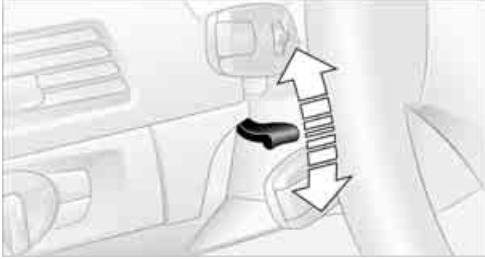

1. Fold the lever down.
2. Move the steering wheel to the preferred height and angle to suit your seated position.
3. Swing the lever back up.

 Do not use force to swing the lever back up; otherwise, the mechanism will be damaged. ◀

Steering wheel heating*

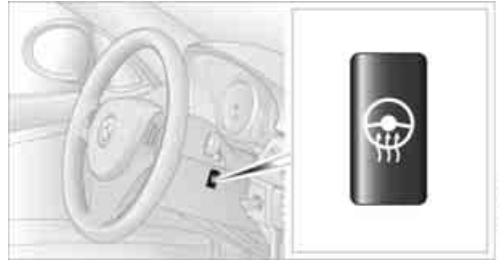

Press the button.

The LED in the button lights up when the steering wheel heating is switched on.

Transporting children safely

The right place for children

 Do not leave children unattended in the vehicle; otherwise, they could endanger themselves and/or other persons by opening the doors, for example. ◀

Children always in the rear

Accident research has shown that the safest place for children is on the rear seat.

 Children under the age of 13 or smaller than 5 ft/150 cm may be transported only in the rear in suitable child restraint systems appropriate for their age, weight and size. Otherwise, there is an increased risk of injury in the event of an accident. ◀

Children 13 years of age or older must be buckled in with a safety belt as soon as there no longer is any child restraint system that is appropriate for their age, size and weight.

Children in the front passenger seat

 Should it be necessary to use a child restraint system on the front passenger seat, the front and side airbags for the front passenger must be deactivated. Otherwise, a child traveling on that seat will face a significant risk of injury if the airbags are triggered off, even with a child restraint system. ◀

For more information on automatic deactivation of the front passenger airbags refer to page 88.

Installing child restraint systems

 Observe the child restraint system manufacturer's instructions when selecting, installing and using child restraint systems. Otherwise, the protective effect may be diminished. ◀

Standard child restraint systems are designed to be secured with a lap belt or with the lap-belt section of a lap-and-shoulder belt. Incorrectly

or improperly installed child restraint systems can increase the risk of injury to children. Always follow the installation instructions for the system with the greatest care.

On the front passenger seat

 After installing a child restraint system on the front passenger seat, make sure that the front and side airbags for the front passenger are deactivated; otherwise, there is an increased risk of injury if the airbags deploy. ◀

Seat position

Before installing a child restraint system, move the front passenger seat as far back and up as possible to obtain the best possible position for the belt. Do not change the seat position after this.

Backrest width*

 The backrest width of the front passenger seat must be at its widest possible setting. Do not change the setting after installing the child seat. Otherwise, the child seat's stability on the front passenger seat is limited. ◀

1. Adjust the backrest width to its widest setting, refer to page 38.
2. Install the child seat.

Child seat security



The rear safety belts and the front passenger safety belt can be prevented from being pulled out in order to fasten child restraint systems.

To lock the safety belt

1. Secure the child restraint system with the belt.
2. Pull the belt strap all the way out.
3. Allow the belt strap to retract and pull it taut against the child restraint system.

The safety belt is locked.

To unlock the safety belt

1. Open the belt buckle.
2. Remove the child restraint system.
3. Allow the safety belt strap to retract all the way.

LATCH child restraint fixing system

LATCH: Lower Anchors and Tethers for Children.

⚠ To install and use the LATCH child restraint system, follow the operating and safety instructions provided by the manufacturer of the system; otherwise, the protective function of the seat may be compromised. ◀

Mounts for the lower LATCH anchors

Before installing the child seat, pull the belt out of the area for the child restraint fixing system.

⚠ Ensure that both lower LATCH anchors are correctly engaged and that the child restraint system is resting firmly against the backrest; otherwise, the protective function of the seat may be compromised. ◀



The anchor points for the lower LATCH anchors are located behind the labeled protective caps.

Upper LATCH retaining strap

Convertible

For Canadian Customers Only.

The following statement is required by Transport Canada.

This vehicle is not equipped with user-ready tether anchorages. As such neither a child restraint system, nor a booster cushion, requiring the use of a tether strap can be properly secured in the vehicle.

Coupe

⚠ Use the top tether anchors to secure child restraint systems only; otherwise, the anchors could be damaged. ◀



For child restraint systems with tether straps there are two additional anchors, see arrows.

Placement of the tether strap

Coupe

 Make sure the upper retaining strap does not run over sharp edges and is not twisted as it passes to the top anchor. Otherwise, the strap will not properly secure the child restraint system in the event of an accident. ◀

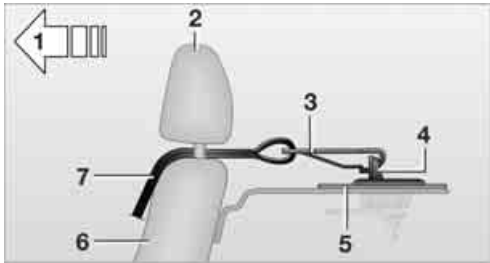

- 1 Direction of travel
- 2 Head restraint
- 3 Hook for upper retaining strap
- 4 Anchor
- 5 Rear window shelf
- 6 Seat backrest
- 7 Upper retaining strap of child restraint system

If necessary, fold the anchors upward before use.

1. Push the head restraint upward.
2. Guide the upper retaining strap between the head restraint holders.
3. Use the hook to clip the retaining strap to the anchor.
4. Push the head restraint into its lowermost position.
5. Pull the retaining strap taut.

Driving

Ignition lock

Insert the remote control into the ignition lock



Insert the remote control all the way into the ignition lock.

- ▷ Radio readiness is switched on. Individual electrical consumers can operate.

Comfort Access*

If the car is equipped with Comfort Access, only insert the remote control into the ignition lock under special circumstances, refer to page 27.

Removing the remote control from the ignition lock

 Do not forcibly pull the remote control out of the ignition lock as this may cause damage. ◀

Before removing the remote control, push it all the way in to release the locking mechanism.

- ▷ The ignition is switched off if it was on.

Automatic transmission

You cannot take out the remote control unless the selector lever is in the P position: interlock.

Start/stop button



Pressing the start/stop button switches radio readiness or the ignition on or off.

- ▷ Manual transmission: when you press the start/stop button and depress the clutch, the engine starts.
- Automatic transmission and Sports automatic transmission with double clutch: when you press the start/stop button and depress the brake pedal, the engine starts. ◀

Radio readiness

Individual electrical consumers can operate. The time and the outside temperature are displayed in the instrument cluster.

Radio readiness is switched off automatically:

- ▷ When the remote control is removed from the ignition lock
- ▷ In cars with Comfort Access*, by touching the surface above the door lock, refer to Locking on page 28

Ignition on

All electrical consumers can operate. The odometer and trip odometer are displayed in the instrument cluster.

- ▷ When the engine is off, please switch off the ignition and any unnecessary electrical consumers in order to preserve the battery. ◀

Radio readiness and ignition off

All indicator and warning lamps as well as displays in the instrument cluster go out.

Starting the engine

 Do not run the engine in enclosed areas; otherwise, the inhalation of toxic exhaust gases can cause loss of consciousness and death. The exhaust gases contain carbon monoxide, an odorless and colorless, but highly toxic gas. Never leave an unattended vehicle with the engine running; otherwise, such a vehicle represents a potential safety hazard. Before leaving the vehicle with the engine running, always shift into neutral or selector lever / transmission position P and apply the parking brake forcefully to prevent the vehicle from rolling. ◀

 Avoid frequent starting in quick succession as well as repeated start attempts in which the engine does not start. Otherwise, the fuel is not burned or incompletely burned and there is a danger of overheating and damaging the catalytic converter. ◀

Do not wait for the engine to warm up while the vehicle remains stationary. Start driving right away, but at moderate engine speeds.



Manual transmission

Remote control in the ignition lock or, with Comfort Access, inside the vehicle, refer to page 27.

1. Depress the brake.
2. Depress the clutch and shift to neutral position.
3. Press the start/stop button.

The starter operates automatically for a certain time, and stops automatically as soon as the engine has started.

Automatic transmission

Remote control in the ignition lock or, with Comfort Access, inside the vehicle, refer to page 27.

1. Depress the brake.
2. Move the selector lever to position P.
3. Press the start/stop button.

The starter operates automatically for a certain time, and stops automatically as soon as the engine has started.

Sports automatic transmission with double clutch

Remote control in the ignition lock or, with Comfort Access, inside the vehicle, refer to page 27.

1. Depress the brake.
2. Press the start/stop button.

The engine starts independent of the current transmission position.

Switching off the engine

 Always take the remote control with you when you leave the vehicle.

When parking, apply the parking brake forcefully; otherwise, the vehicle could begin to roll. ◀

Manual transmission

1. With the car at a standstill, press the start/stop button.
2. Shift into first gear or reverse.
3. Forcefully apply the parking brake.
4. Removing the remote control from the ignition lock, refer to page 50.

Automatic transmission

1. With the car at a standstill, move the selector lever to position P.
2. Press the start/stop button.
3. Forcefully apply the parking brake.
4. Removing the remote control from the ignition lock, refer to page 50.

Sports automatic transmission with double clutch

1. With the car at a standstill, press the start/stop button.
If the transmission is shifted into N when the engine is switched off, you will be notified visually and acoustically of this fact.
2. Forcefully apply the parking brake.
3. Remove remote control from the ignition lock, refer to page 50. The transmission is automatically shifted into transmission position P.

Parking brake

The parking brake is primarily intended to prevent the vehicle from rolling while parked; it brakes the rear wheels.

Indicator lamp

 The indicator lamp is lit, and when you drive off an acoustic signal sounds in addition. The parking brake is still applied.

 Indicator lamp for Canadian models.

Applying

The lever locks in position automatically.

Releasing

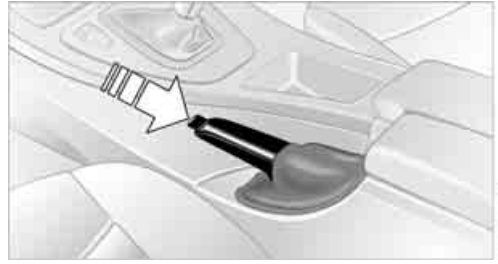

Pull slightly upwards, press the button and lower the lever.

 In exceptional cases, if the parking brake has to be used to slow or stop the car, do not pull the lever up too hard. In doing so, continuously press the button of the parking brake lever.

Otherwise, excessive force on the parking brake can lock up the rear wheels and cause the rear of the car to swerve. ◀

 To prevent corrosion and one-sided braking action, occasionally apply the parking brake lightly when the vehicle is slowly coming to a stop if the traffic conditions are suitable. The brake lamps do not light up when the parking brake is applied. ◀

Manual transmission



 When shifting into 5th or 6th gear, press the gearshift lever to the right. Otherwise, the engine could be damaged if you inadvertently shift into 3rd or 4th gear. ◀

Reverse gear

Select this only when the vehicle is stationary. When the gearshift lever is pressed to the left, a slight resistance has to be overcome.

Automatic transmission with Steptronic*

In addition to fully automatic operation, you can also manually shift with the Steptronic, refer to page 54.

Vehicle parking

 To prevent the vehicle from rolling, always select position P and apply the parking brake before leaving the vehicle with the engine running. ◀

Disengaging the remote control

In order to remove the remote control from the ignition lock, you must first move the selector lever to position P and switch off the engine: interlock. Removing the remote control from the ignition lock, refer to page 50.

Selector lever positions

P R N D M/S + -

Displays in the instrument cluster



The selector lever position is displayed and, in manual mode, the engaged gear, e.g. M4.

Changing selector lever positions

▷ With the ignition switched on or the engine running, the selector lever can be moved out of position P.

▷ Before moving the lever away from P or N with the vehicle stationary, first depress the brake; otherwise, the selector lever will refuse to move: shiftlock.



To prevent the vehicle from creeping after you select a driving position, depress the brake until you are ready to start. ◀



A lock prevents you from inadvertently engaging selector lever positions R and P. To cancel the lock, press the button on the front of the selector lever, see arrow.

P Park

Select this only when the vehicle is stationary. The rear wheels are locked.

R Reverse

Select this only when the vehicle is stationary.

N Neutral

You can select this in a car wash, for example. The vehicle can roll.

D Drive, automatic position

Position for normal vehicle operation. All forward gears are selected automatically.

Under normal operating conditions, fuel consumption is lowest when you are driving in position D.

Kickdown

Kickdown enables you to achieve maximum performance. Press the accelerator pedal beyond the full-throttle resistance point.

Sport program and manual operation M/S



Move selector lever from position D toward the left into the M/S shifting slot; the Sport program is activated. This position is recommended for a performance-oriented driving style.

DS is displayed in the instrument cluster.

To deactivate the sport program or manual mode M/S, move the selector lever to the right into position D.

Shifting gears via the selector lever

Move selector lever from position D toward the left into the M/S shifting slot:

When you press the selector lever forwards or backwards, the manual mode is activated and Steptronic changes gear.

The engaged gear, e.g. M1 is displayed in the instrument cluster.

Upshifts and downshifts are executed only when they will result in a plausible combination of engine and vehicle speed; thus, for example, a downshift that would cause the engine to overrev will not be executed by the system.

The gear selected is briefly displayed in the instrument cluster, followed again by the gear actually in use.

Shifting gears via shift paddles* on the steering wheel

The shift paddles allow you to shift gears quickly since both hands can remain on the steering wheel.

- ▷ When you use the shift paddles on the steering wheel to shift gears in automatic mode, the transmission switches to manual mode.
- ▷ If you do not accelerate or shift gears using the shift paddles for a certain amount of time, the transmission switches back to automatic mode.

▷ If the selector lever is in the M/S gear plane, manual mode remains active. ◀

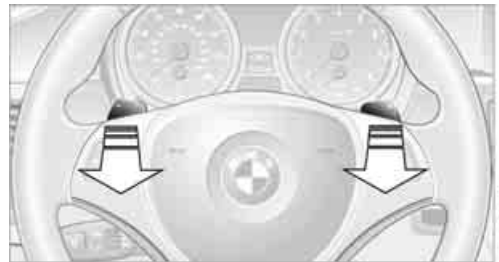

- ▷ To upshift, briefly pull the right shift paddle +.
- ▷ To downshift, briefly pull the left shift paddle -.

Upshifts and downshifts are executed only when they will result in a plausible combination of engine and vehicle speed; thus, for example, a downshift that would cause the engine to overrev will not be executed by the system.

The gear selected is briefly displayed in the instrument cluster, followed again by the gear actually in use.

Overriding selector lever lock

Should the selector lever refuse to move out of position P even though the ignition is switched on, the brake is depressed and the button on the selector lever is pressed, the selector lever lock can be overridden:

1. Unclip the sleeve of the selector lever.
2. Pull the sleeve up over the selector lever until the sleeve is inside out.

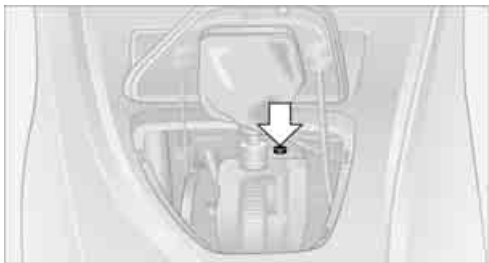

3. Using the screwdriver from the onboard vehicle tool kit, refer to page 154, press the red lever while moving the selector lever to the desired position.

7-gear Sports automatic transmission with double clutch*

The concept

The 7-gear Sports automatic transmission with double clutch is an automated manual transmission with two clutches and secondary gear sets in which the clutching and shifting is handled by an electrohydraulic system. With the 7-gear Sports automatic transmission with double clutch, the gears are shifted without an interruption in driving power.

You operate the 7-gear Sports automatic transmission with double clutch using the selector lever and two shift paddles on the steering wheel.

It offers you the following functions:

- ▷ either manual or automatic mode: sequential mode or drive mode

- ▷ automatic downshifting and protection against incorrect gear selection, even in sequential mode
- ▷ Launch Control, refer to page 59
- ▷ Automatic throttle blip

System limitations

The 7-gear Sports automatic transmission with double clutch has an overheating protection that protects the clutch from extreme loads.



The indicator lamp lights up in yellow if the transmission becomes too warm.

Avoid high engine loads and frequent accelerations from zero. If the transmission is overheated, the indicator lamp lights up in red and the power flow to the motor is interrupted. It is only possible to continue driving once the transmission has cooled down.

Avoid frequent powerful accelerations from zero and do not hold the vehicle on inclines by pressing lightly on the accelerator while letting the clutch slip, as this may cause the transmission to overheat.

Selector lever positions

P R N D M/S + -

Displays in the instrument cluster



The selector lever position and the engaged gear are displayed, e.g. M4.

Engaging selector lever positions

- ▷ The selector lever can be moved out of position P only with the engine running: interlock.
- ▷ Before moving the lever away from P or N with the vehicle stationary, first depress the brake; otherwise, the desired shift will not be executed: shiftlock.

Shifting into N, D, R



Briefly push the selector lever in the desired direction, overcoming a resistance point if necessary. When shifting out of P or into R, simultaneously press the button **1**.

The engaged selector lever position is also displayed on the selector lever.

When you release the selector lever, it returns to its center position.

Shifting into P

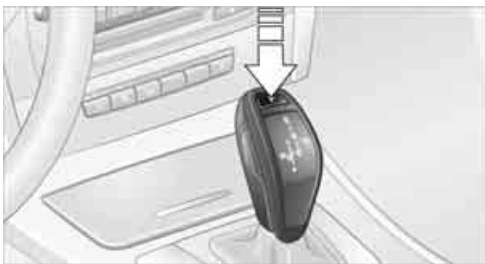

Press the button **P**.

P Park

Select this only when the vehicle is stationary. The rear wheels are locked.

▷ The transmission is shifted into P if, with the engine running, you open the driver's door, do not have your safety belt fastened, and subsequently actuate neither the brake pedal nor the accelerator. ◀

▷ The transmission is shifted into P as soon as you switch off the engine, unless the transmission is in N and the remote control is in the ignition lock, refer to page 151. As soon as you remove the remote control from the ignition lock, then the transmission is shifted into P. ◀

R Reverse

Select this only when the vehicle is stationary.

N Neutral

You can select this in a car wash, for example. The vehicle can roll.

▷ After the engine is switched off, the transmission remains in N if you leave the remote control in the ignition lock. You can use this function at a car wash, for example, refer to page 151. ◀

D Drive mode

In Drive mode, all forward gears are shifted automatically.

Kickdown

For sudden acceleration maneuvers such as passing, depress the accelerator past the resistance point. This provides maximum acceleration.

Sport program and manual operation M/S



Push selector lever toward the left from the selector lever position D, the Sport program is activated. This position is recommended for a performance-oriented driving style. The engaged gear, e.g. S1, is displayed in the instrument cluster.

When you press the selector lever forwards or backwards, the manual mode is activated and Steptronic changes gear.

The engaged gear, e.g. M1 is displayed in the instrument cluster.

In the following situations, the 7-gear Sports automatic transmission with double clutch does the thinking for you:

- ▶ Upshifts and downshifts are executed only when they will result in a plausible combination of engine and vehicle speed; thus, for example, a downshift that could cause the engine to overrev will not be executed by the system.
- ▶ At a stop, the transmission is automatically shifted down to the first gear.
- ▶ Shortly before the speed falls below a gear-dependent minimum speed, the transmission automatically downshifts without your intervention.

Quick downshifting: Even in sequential mode, you can skip over several gears in order to achieve an optimum acceleration. To do so, depress the accelerator past the resistance point.

To return to automatic mode, push the selector lever to the right.

Gear shifting

Upshift or downshift using the selector lever or the shift paddles. You do not need to lift your foot off the accelerator when doing so.

Using the selector lever

- ▶ To upshift, pull the selector lever toward the rear.
- ▶ To downshift, push it toward the front.

Using the shift paddles on the steering wheel

You can also shift manually using two shift paddles on the steering wheel. The shift paddles allow you to shift gears quickly since both hands can remain on the steering wheel.

- ▶ When you use the shift paddles on the steering wheel to shift gears in automatic mode, the transmission switches to manual mode.
- ▶ If you do not accelerate or shift gears using the shift paddles for a certain amount of time, the transmission switches back to automatic mode if the selector lever is in position D.



- ▶ To upshift, briefly pull the right shift paddle +.
- ▶ To downshift, briefly pull the left shift paddle -.

Driving dynamics control

The driving dynamics control permits you, at the push of a button, to have your BMW react in an even more sporty fashion when driving:

- ▷ Optimal use is made of the engine's speed range.
- ▷ Gear changes occur more quickly.
- ▷ The engine reacts more spontaneously to accelerator pedal movements.

Activating the system



Press the SPORT button. The LED in the button lights up and SPORT appears in the info display.

Deactivating the system

- ▷ Press the SPORT button again
- ▷ Switching off the engine

The LED in the button lights up and SPORT appears in the info display.

Manually unlocking parking lock

 In the event of a power supply interruption such as a discharged or disconnected battery or an electrical malfunction, the parking lock must be manually unlocked; otherwise, the rear wheels are immobilized and the vehicle cannot be towed. ◀

Only unlock the parking lock manually for towing and make sure to set the parking brake forcefully beforehand so that the vehicle cannot roll. Lock the parking lock again after the vehicle is parked.

Releasing

1. Unclip the sleeve of the selector lever.
2. Pull the sleeve up over the selector lever until the sleeve is inside out.



3. Using the allen wrench from the toolkit, refer to page 154, rotate the cover until it reaches the stop, arrow 1, and remove, arrow 2.



4. Insert allen wrench into the opening, arrow 1.

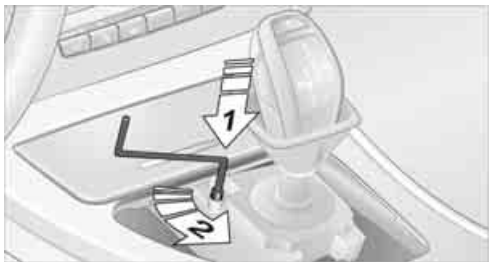

5. Rotate allen wrench until it reaches the stop, arrow 2. The parking lock is unlocked.

 Do not turn allen wrench in the opposite direction; otherwise, you may damage the mechanism. ◀

6. Remove allen wrench from the opening.

 After parking the vehicle, lock the parking lock again. Otherwise, there is a danger that the vehicle will roll. ◀

Locking

1. Press the button, see arrow. The parking lock is locked again.



2. Replace cover again.
3. Clip the selector lever sleeve back into place.
4. Forcefully apply the parking brake.

Jump-starting and towing, starting on page 161.

Launch Control

Launch Control enables an optimum acceleration when starting off on a road surface with good traction.

 Do not use Launch Control too often; otherwise, the powerful stresses on the vehicle will lead to premature component wear. ◀

Launch Control is available when the engine is at operating temperature, i.e. after driving continuously for approx. 6.2 miles/10 km.

1. With the engine running, step on the brake with your left foot.
2. Activate Dynamic Traction Control (DTC), refer to page 81.
3. Activate Driving dynamics control, refer to page 58.
4. With the vehicle stationary, activate the manual mode and select 1st gear.
5. With your right foot, push the accelerator pedal past the resistance point. The engine speed for pulling away is adjusted. A flag symbol appears in the instrument cluster.
6. When you release the brake pedal, the vehicle accelerates. Keep the accelerator pedal floored.
7. The upshifting occurs automatically as long as you keep the accelerator pedal pressed past the resistance point.

Launch Control will be ready for use again after you drive a certain distance.

Launch Control is not available for use during the break-in phase, refer to page 120.

 To maintain driving stability, keep DSC activated whenever possible. ◀

Turn signals/ headlamp flasher

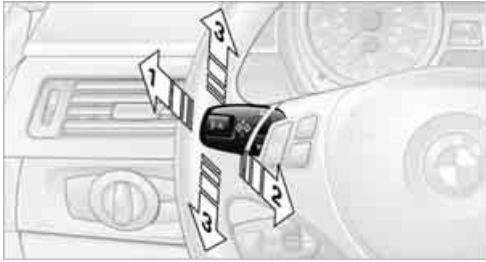

- 1 High beams
- 2 Headlamp flasher
- 3 Turn signals

Using turn signals

Press the lever beyond the resistance point.

To turn off manually, press the lever to the resistance point.

 Unusually rapid flashing of the indicator lamp indicates that a turn signal indicator has failed. ◀

Indicating a turn briefly

Press the lever as far as the resistance point for as long as you wish to indicate a turn.

Triple turn signal activation

Press the lever as far as the resistance point. The turn signals flash three times.

You can activate or deactivate this function.

1. Switch on the ignition, refer to page 50.
2. Lightly push button 1 in the turn indicator lever up or down repeatedly until the symbol appears in the display accompanied by the word "SET".



3. Press button 2.
4. Lightly push button 1 in the turn indicator lever down repeatedly until the symbol appears in the display.



5. Press button 2.
6. Use button 1 to select:
 - ▷ 1 x
Turn signals flash once.
 - ▷ 3 x
Triple turn signal.
7. Press button 2.
The setting is stored for the remote control currently in use.

Wiper system

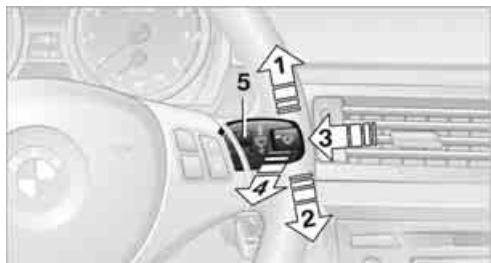

- 1 Switching on wipers
- 2 Switching off wipers or brief wipe
- 3 Activating/deactivating intermittent wipe or rain sensor*
- 4 Cleaning windshield and headlamps*
- 5 Setting speed for intermittent wipe, or sensitivity of the rain sensor

Switching on wipers

Press the lever upward, arrow 1.

The lever automatically returns to its initial position when released.

Normal wiper speed

Press once.

The system switches to operation in the intermittent mode when the vehicle is stationary.

Fast wiper speed

Press twice or press beyond the resistance point.

The system switches to normal speed when the vehicle is stationary.

Intermittent wipe or rain sensor*

If the car is not equipped with a rain sensor, the intermittent-wipe time is a preset.

If the car is equipped with a rain sensor, the time between wipes is controlled automatically and depends on the intensity of the rainfall. The rain sensor is mounted on the windshield, directly in front of the interior rearview mirror.

Activating intermittent wipe or rain sensor

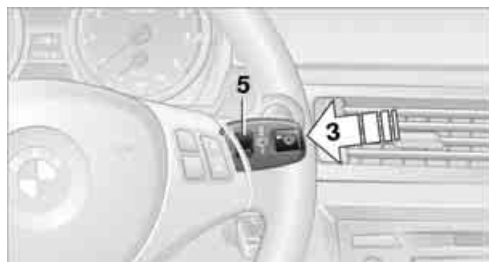

Press the button, arrow 3. The LED in the button lights up.

Setting speed for intermittent wipe or sensitivity of the rain sensor

Turn thumbwheel 5 up or down.

Deactivating intermittent wipe or rain sensor

Press the button again, arrow 3. The LED goes out.

 Deactivate the rain sensor before entering an automatic car wash. Failure to do so could result in damage caused by undesired wiper activation. ◀

Cleaning windshield and headlamps*

Pull the lever, arrow 4.

Washer fluid is sprayed onto the windshield and the wipers are operated for a short time.

When the vehicle lighting system is switched on, the headlamps are cleaned at regular and appropriate intervals.

 Do not use the washers if there is any danger that the fluid will freeze on the windshield. If you do, your vision could be obscured. Antifreeze should therefore be added to the fluid, refer to Washer fluid. Do not use the washers when the washer fluid reservoir is empty; otherwise, you will damage the washer pump. ◀

Windshield washer nozzles

The windshield washer nozzles are heated automatically* while the engine is running or the ignition is switched on.

Washer fluid

⚠ Washer fluid antifreeze is flammable. Therefore, keep it away from ignition sources and only store it in the closed original container that is kept out of reach of children; otherwise, there is a risk of personal injury. Comply with the instructions on the container. ◀

Washer fluid filler neck

⚠ Only refill washer fluid when the engine is cool to avoid contact with hot engine parts. Otherwise, fluid spills constitute a fire hazard and a risk to personal safety. ◀

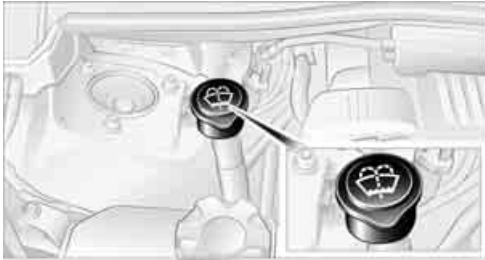

All washer nozzles are supplied with washer fluid by the same reservoir.

Fill with water and, if required, with a washer antifreeze, according to manufacturer's recommendations.

▶ Mix the water and antifreeze before filling the washer fluid reservoir to make sure the correct concentration is maintained. ◀

Capacity

Approx. 6.3 US quarts/6 liters.

Cruise control*

The concept

Cruise control is available for use at speeds of approx. 20 mph or 30 km/h. The car then stores and maintains the speed that you specify using the lever on the steering column. In order to maintain the specified speed, the system brakes the vehicle when the engine braking effect is insufficient on downhill gradients.

⚠ Do not use cruise control when driving at constant speed is prevented by adverse conditions, e.g. winding roads, dense traffic or poor road conditions due to, e.g., snow, rain, ice or loose surfaces. Otherwise, you could lose control of the vehicle and cause an accident as a result. ◀

Manual transmission

You can shift gears while cruise control is activated. The system is deactivated when you drive at very low engine speeds for an extended period.

One lever for all functions

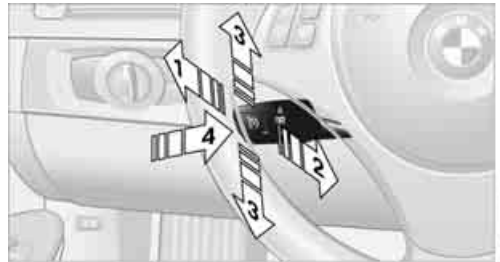

- 1 Storing and maintaining speed or accelerating
- 2 Storing and maintaining speed or decelerating
- 3 Deactivating cruise control
- 4 Resuming a speed stored beforehand

Maintaining current speed

Tap the lever, arrow **1**, or pull it briefly, arrow **2**. The car's current speed is stored and maintained. It is displayed on the speedometer and briefly in the instrument cluster.

On uphill gradients, it may prove impossible to maintain the set speed if current engine power output is insufficient. If the engine braking effect is insufficient on downhill slopes, the system will brake the vehicle slightly.

Increasing desired speed

Repeatedly press the lever to the resistance point or beyond, arrow **1**, until the desired speed is reached.

- ▷ Each time the lever is pressed to the resistance point, the desired speed is increased by approx. 1 mph or 1 km/h.
- ▷ Each time the lever is pressed beyond the resistance point, the desired speed is increased by up to 5 mph or 10 km/h.

The system stores and maintains the speed.

Accelerating using the lever

Accelerating slightly:

Press the lever to the resistance point, arrow **1**, until the desired speed is reached.

Accelerating significantly:

Press the lever beyond the resistance point, arrow **1**, until the desired speed is reached.

The vehicle accelerates without pressure on the accelerator pedal. The system stores and maintains the speed.

Decreasing speed

Repeatedly pull the lever to the resistance point or beyond, arrow **2**, until the desired speed is displayed.

- ▷ Each time the lever is pulled to the resistance point, the desired speed is decreased by approx. 1 mph or 1 km/h.
- ▷ Each time the lever is pulled beyond the resistance point, the desired speed is reduced by up to 5 mph or 10 km/h until the minimum speed of 20 mph or 30 km/h is achieved.

The system stores and maintains the speed.

Deactivating cruise control

Tap the lever upwards or downwards, arrow **3**. The displays on the speedometer disappear.

In addition, the system is automatically deactivated:

- ▷ When you brake the vehicle
- ▷ When you switch gears very slowly or shift to neutral in cars with manual transmission
- ▷ When you select the automatic transmission's neutral position N
- ▷ When you select the neutral position N with the Sports automatic transmission with double clutch
- ▷ When you activate DTC or deactivate DSC
- ▷ When DSC or ABS is intervening

Cruise control is not deactivated by depressing the accelerator pedal. Once the accelerator pedal is released, the stored speed is achieved again and maintained.

Warning lamp



The warning lamp lights up when cruise control is deactivated due to control intervention by the DSC, for example.

Resuming a speed stored beforehand

Press the button, arrow **4**. The last stored speed is resumed and maintained.

In the following instances, the stored speed is deleted and can no longer be resumed:

- ▷ When driving stability control systems are intervening
- ▷ In cars with manual transmission: when you shift gears very slowly or shift to neutral
- ▷ In cars with automatic transmission: when you engage selector lever position N
- ▷ In cars with Sports automatic transmission with double clutch: when you engage selector lever position N
- ▷ When the ignition is switched off

Displays in the instrument cluster



1 Stored speed

2 Selected speed is displayed briefly

 If --- mph or --- km/h temporarily appears in the instrument cluster display, it is possible that the system prerequisites for operation are currently not met.

Calling up Check Control messages, refer to page **78**. ◀

Malfunction



The warning lamp comes on when the system has failed. More information can be found beginning on

page **164**.

Active cruise control*

The concept

With active cruise control, you can select a desired speed which is not only automatically maintained when driving on open roadways, but also varied to maintain a selected distance setting as slower traffic is encountered.

Active cruise control is a technological advance over the familiar cruise control and is a welcome relief from the constant adjustment of speed that can accompany driving in traffic on highways or other high-speed thoroughfares. Especially on longer trips, the system can reduce fatigue and tension, while increasing your enjoyment of driving. Please use it safely and responsibly.

Within the limits of its capability, the system automatically adapts the car's speed to that of a slower vehicle in front of you. You can specify the distance to be maintained from the vehicle in front in four stages. For safety reasons, the distance is speed-dependent. Based on your selected distance setting, the system automatically decreases the throttle setting and lightly applies the brakes if necessary. The vehicle brake lamps will automatically illuminate to signal a following driver to take action. In addition, it may be necessary for the vehicle or the driver to downshift, depending on the kind of transmission your vehicle is equipped with, to maintain the distance setting selected. If the vehicle ahead speeds up or when the lane ahead becomes clear, your vehicle will accelerate to the speed you have selected by increasing the throttle setting and shifting gears automatically or by the driver as needed. Your selected speed will be held when driving downhill, too.

Since this active cruise control system is a new technology and operates differently from conventional cruise control systems which you may be accustomed to, you are strongly urged to read all of the pages relating to this system before use. Pay special attention to the System limitations section beginning on page **69**.

Braking sensation

- ▷ If you step on the brake pedal while the system is braking, pedal sensation will be slightly different from the usual.
- ▷ Possible noises during automatic braking are normal.

Manual transmission

You can shift gears while cruise control is activated. The system is deactivated when you drive at very low engine speeds for an extended period.

Range of applications

The minimum desired speed is 20 mph or 30 km/h, the maximum desired speed is 110 mph or 180 km/h.

 As with conventional cruise control systems, active cruise control in no way diminishes or substitutes for the driver's own personal responsibility, alertness and awareness in adjusting speed, braking or otherwise controlling the vehicle. The driver should decide when to use the system on the basis of road, traffic, visibility, and weather conditions. Active cruise control is intended for use on highway-type roadways where traffic is moving relatively smoothly. Do not use this system in city driving; heavy traffic such as during rush hour; on curvy, winding roads, slippery roads or roads with sharp curves such as highway off-ramps; during inclement weather such as snow, strong rain or fog; or when entering interchanges, service/parking areas or toll booths. It is also important to regulate your vehicle's speed and distance setting within applicable legal limits. Always be ready to take action or apply the brakes if necessary, especially when the system is actively following a vehicle in front of you. Otherwise, driving situations could result that pose the risk of accidents. ◀

One lever for all functions

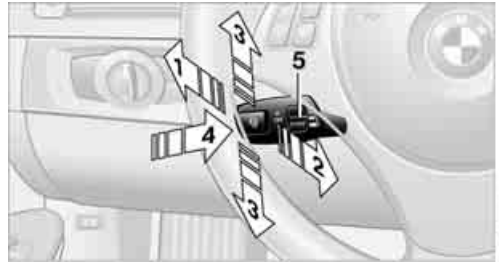

- 1 Store and increase desired speed
- 2 Store and decrease desired speed
- 3 Deactivate system, refer to page 66
- 4 Resume stored desired speed and distance, refer to page 67
- 5 Select distance to vehicle driving ahead, refer to page 66

Storing current speed

Briefly push lever, arrow 1, or pull lever, arrow 2, at a driving speed of more than approx. 20 mph or 30 km/h.



The car's current speed is stored. It is displayed on the speedometer and briefly in the instrument cluster.

Increasing desired speed

Press or tap the lever to the resistance point or beyond, arrow **1**, until the desired speed is displayed.

- ▷ Each time the lever is tapped to the resistance point, the desired speed is increased by approx. 1 mph or 1 km/h.
- ▷ Each time the lever is tapped beyond the resistance point, the desired speed is increased by up to 5 mph or 10 km/h until the maximum speed of 110 mph or 180 km/h is achieved.

The speed then displayed is stored and achieved on a clear road.

Decreasing desired speed

Pull the lever, arrow **2**, until the desired speed is displayed.

The other functions work analogously to those described under Increasing desired speed.

Selecting distance

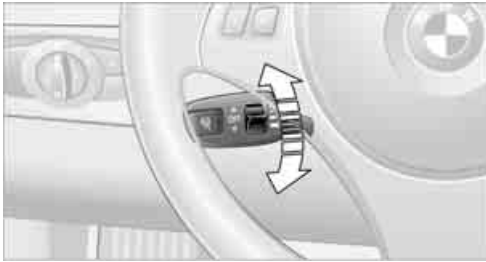

- ▷ Press downward: Increase distance.
- ▷ Press upward: Decrease distance.

The selected distance is displayed in the instrument cluster.



Distance 1



Distance 2



Distance 3



Distance 4

This is always the preset distance when you use the system for the first time after starting the engine.

 Use good judgment to select the appropriate following distance given road conditions, traffic, applicable laws and driving recommendations for safe following distance. Otherwise, an accident risk could result. ◀

Deactivating cruise control

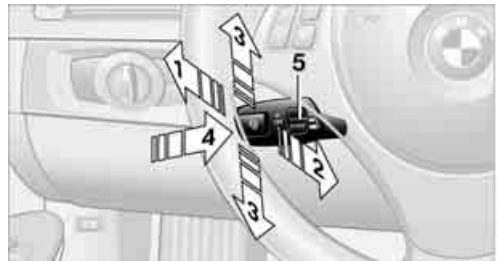

Press the lever upward or downward, arrow **3**. The displays on the speedometer disappear.

In addition, the system is automatically deactivated:

- ▷ When you brake the vehicle
- ▷ When the speed is reduced to below 20 mph or 30 km/h due to a traffic situation
- ▷ When you switch gears very slowly or shift to neutral in cars with manual transmission

- ▷ When you select the automatic transmission's neutral position N
- ▷ When you select the neutral position N with the Sports automatic transmission with double clutch
- ▷ When you activate the Dynamic Traction Control DTC
- ▷ When you deactivate the Dynamic Stability Control DSC
- ▷ When DSC or ABS is intervening
- ▷ When the system does not recognize any objects for a longer period of time, e.g. on infrequently traveled roads without a shoulder or guard rails, or if the radar sensor is covered with dirt, refer to page 68
- ▷ When you apply the parking brake

 When the system is deactivated, you must brake the vehicle yourself and/or maneuver as necessary; otherwise, there is a risk of accidents. ◀

Warning lamp

 The warning lamp comes on when active cruise control has been automatically deactivated, for example due to a driving speed below 20 mph or 30 km/h or a DSC intervention.

Resuming stored desired speed and distance

Briefly press the button, arrow 4. The stored speed and distance are regained and maintained.

In the following instances, the stored speed is deleted and can no longer be resumed:

- ▷ When driving stability control systems are intervening
- ▷ In cars with manual transmission: when you shift gears very slowly or shift to neutral
- ▷ In cars with automatic transmission: when you engage selector lever position N
- ▷ In cars with Sports automatic transmission with double clutch: when you engage selector lever position N
- ▷ When the ignition is switched off

Displays in the instrument cluster



- 1 Stored desired speed
- 2 Shows yellow: vehicle detected ahead
Flashes in red: system cannot maintain distance; driver must brake the vehicle
Flashes in yellow: driving stability control systems are intervening; cruise control is deactivated
- 3 Selected distance to vehicle ahead
The indicator lights up as soon as the system is activated.
- 4 Selected desired speed is temporarily displayed

 If --- mph or --- km/h temporarily appears in the instrument cluster display, it is possible that the system prerequisites for operation are currently not met. Calling up Check Control messages, refer to page 78. ◀

Warning lamps



The indicator **2** flashes in red; a signal sounds.

The system indicates that you must brake and/or maneuver the vehicle yourself. Active cruise control cannot automatically restore the distance to the vehicle ahead.

This indicator does not release you from your responsibility to adapt your desired speed and driving style to prevailing driving conditions.



The indicator **2** flashes in yellow.

The prerequisites for operating active cruise control are not met, e.g. as a result of ABS or DSC interventions. Active cruise control is deactivated. You can reactivate the system, if desired, by tapping or pulling the lever when road and traffic conditions permit. It is not possible to resume a stored speed.

The prerequisites for operating active cruise control are not met, e.g. as a result of ABS or DSC interventions. Active cruise control is deactivated. You can reactivate the system, if desired, by tapping or pulling the lever when road and traffic conditions permit. It is not possible to resume a stored speed.

Radar sensor



The sensor's ability to detect vehicles ahead may be restricted as a result of heavy rain, dirt, snow or ice. If necessary, clean the radar sensor located in the front bumper, see arrow. Be sure to use particular care when removing any layers of snow or ice from the sensor.

The system cannot be activated if the sensor is incorrectly aligned.

For US owners only

The transmitter and receiver units comply with part 15 of the FCC/Federal Communications Commission regulations. Operation is governed by the following:

FCC ID:

NF3 ACC2SCU 003YK04001 0000

Compliance statement:

This device complies with part 15 of the FCC Rules. Operation is subject to the following two conditions:

- ▷ This device must not cause harmful interference, and
- ▷ this device must accept any interference received, including interference that may cause undesired operation.



Any unauthorized modifications or changes to these devices could void the user's authority to operate this equipment. ◀

Malfunction



The warning lamp comes on when the system has failed. More information can be found beginning on page 164.

System limitations

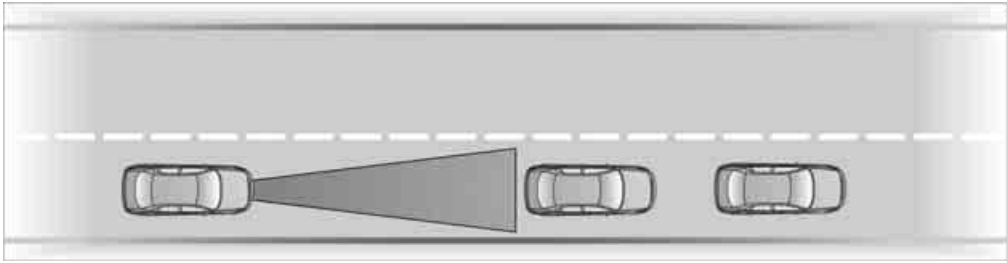

⚠ Always remember that the range and ability of the system does have physical limitations. It will not apply the brakes or decelerate your vehicle when there is a slow-moving vehicle, stopped vehicle or stationary object ahead of you, as for example, at a traffic light or a parked vehicle. Also, the system does not react to oncoming traffic, pedestrians or other types of potential traffic such as a rider on horseback. It is also possible that the system may not detect smaller moving objects such as motorcycles or bicycles. Be especially alert when encountering any of these situations as the system will neither automatically brake, nor provide a warning to you. Also, be aware that every decrease in the distance setting allows your vehicle to come closer to a vehicle in front of you and requires a heightened amount of alertness. ◀

⚠ Active cruise control is not and must not be used as a collision avoidance/warning system. ◀

If while your vehicle is actively following a vehicle in front of you and the vehicle ahead speeds up or the lane ahead becomes clear, then your vehicle will accelerate to the speed you have selected. Be aware that changing to a clear, unobstructed lane will also result in your vehicle accelerating.

⚠ Be certain to deactivate the system when you pull into an exit lane for a highway off-ramp. ◀

Also, vehicles traveling in a staggered manner on a highway may cause a delay in the system's reaction to a vehicle in front of you or may cause the system to react to a vehicle actually in the lane next to you. Always be ready to take action or apply the brakes if necessary.

⚠ While active cruise control is capable of braking your vehicle automatically when you approach a slower vehicle ahead, it is important to be aware that the ability of the system to apply the brakes is also limited, e.g. when you reduce your desired speed sharply. The system cannot stop your vehicle. It uses only a portion of braking system capacity and does not utilize the full capacity of the vehicle braking system. Therefore, the system cannot decrease your speed for large differences in speed between your vehicle and the vehicle ahead. Examples: when you approach a vehicle traveling at a much lower speed than your own speed such as approaching a toll booth or when a much slower vehicle cuts in front of you at close range. ◀

Active cruise control can only decelerate the vehicle to approx. 20 mph or 30 km/h.

Swerving vehicles

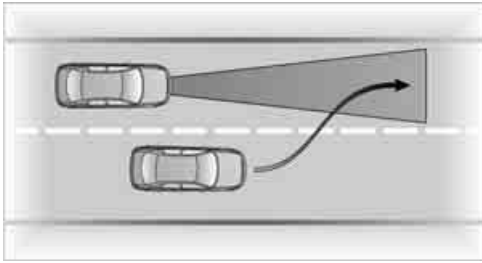

When a vehicle moves from an adjacent lane into your lane, active cruise control will not recognize this vehicle until it is fully in your lane ahead of your vehicle.

⚠ When a vehicle ahead suddenly swerves into your lane, the system may not be able to maintain the selected distance automatically. This also applies to great differences in speed between you and vehicles ahead, e.g. when quickly approaching a truck. There is a risk of collision. Once the system has established that a vehicle is indeed in front of you, it will indicate that you must brake and/or maneuver the vehicle yourself. Take action yourself; otherwise, there is a risk of an accident. ◀

Behavior in curves

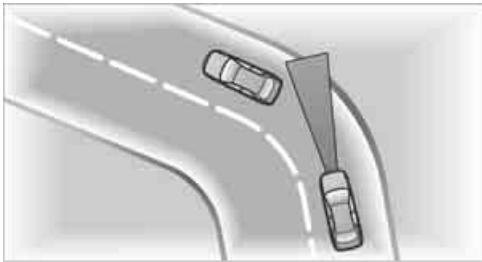

Because of the limited range of the system, it is possible that in curves or on the peaks and valleys of hilly roads, a vehicle ahead may be recognized late, or not at all. Therefore, it is up to the driver to select a speed that is prudent in view of the curves and terrain of the roadway.



In approaching a curve, it is possible that active cruise control would react briefly to a vehicle in the adjacent lane. In addition, the system can sense if your vehicle is in a curve and may not accelerate. If your vehicle decelerates in either case, you can choose to overcome the deceleration by briefly pressing the accelerator pedal.

Your responsibility

Your actions have priority at all times. When you press the accelerator pedal while driving with active cruise control, the automatic braking function will be temporarily interrupted. Once you release the accelerator pedal, the desired speed or the selected distance to the vehicle ahead is achieved again.

⚠ Do not leave your foot on the accelerator pedal and make sure that no objects such as floor mats are lying on the accelerator pedal. Otherwise, the system may not be able to brake the vehicle. ◀

Controls overview

Odometer, outside temperature display, clock



- 1 Knob in the instrument cluster
- 2 Outside temperature display and clock
- 3 Odometer and trip odometer

Knob in the instrument cluster

- ▷ To reset the trip odometer while the ignition is switched on
- ▷ To display the time, outside temperature and odometer briefly while the ignition is switched off

Units of measure

To select the respective units of measure, miles or km for the odometer as well as °F or °C for the outside temperature, refer to page 75.

The setting is stored for the remote control currently in use.

Time, outside temperature display

Setting the time, refer to page 77.

Outside temperature warning

When the displayed temperature sinks to approx. +37 °F / +3 °C, a signal sounds and a warning lamp lights up. There is an increased risk of black ice.

 Black ice can also form at temperatures above +37 °F / +3 °C. You should therefore drive carefully on bridges and shaded roads, for example; otherwise, there is an increased risk of an accident. ◀

Odometer and trip odometer

Resetting the trip odometer:
With the ignition switched on, press button 1 in the instrument cluster.

When the vehicle is parked

If you still want to view the time, outside temperature and odometer reading briefly after the remote control has been taken out of the ignition lock:

Press button 1 in the instrument cluster.

Tachometer



Never force the engine speed up into the red warning field, see arrow. In this range, the fuel supply is interrupted to protect the engine.

Coolant temperature

A warning lamp will come on if the coolant, and therefore the engine, becomes too hot.

Check coolant level, refer to page 147.

Engine oil temperature*



When the engine is at normal operating temperature, the engine oil temperature is between approx. 210 °F / 100 °C and approx. 300 °F / 150 °C.

If the engine oil temperature is too high, a warning lamp comes on in the instrument cluster.

Fuel gauge



Fuel tank capacity: approx. 16.1 gallons/ 61 liters.

You can find information on refueling on page 129.

If the tilt of the vehicle varies for a longer period, when you are driving in mountainous areas, for example, the indicator may fluctuate slightly.

Reserve

Once the fuel level has fallen to the reserve zone of approx. 2.1 US gallons/8 liters, the indicator lamp and the cruising range for the remaining amount of fuel light up briefly. The indicator lamp remains permanently on when the remaining range is less than approx. 30 miles/50 km.

 Refuel as soon as possible once your cruising range falls below 30 miles/ 50 km; otherwise, engine functions are not ensured and damage can occur. ◀

Computer

Displays in the instrument cluster

Calling up information



Press the button in the turn indicator lever.

The following items of information are displayed in the order listed:

- ▷ Cruising range
- ▷ Average speed
- ▷ Average fuel consumption
- ▷ Current fuel consumption*
- ▷ No information

To set the corresponding units of measure, refer to Formats and units of measure on page 75.

Cruising range

Displays the estimated cruising range available with the remaining fuel. The range is calculated on the basis of the way the car has been driven over the last 18 miles/30 km and the amount of fuel currently in the tank.

 Refuel as soon as possible once your cruising range falls below 30 miles/50 km; otherwise, engine functions are not ensured and damage can occur. ◀

Average speed

Periods with the vehicle parked and the engine switched off are not included in the calculations of average speed.

To reset average speed: press the button in the turn indicator lever for approx. 2 seconds.

Average fuel consumption

The average fuel consumption is calculated for the time during which the engine is running.

To reset average fuel consumption: press the button in the turn indicator lever for approx. 2 seconds.

Current fuel consumption

Displays the current fuel consumption. This allows you to see whether your current driving style is conducive to fuel economy with minimum exhaust emissions.

Settings and information

Operating principle



Certain settings and information can only be called up when the ignition is switched on. A number of settings cannot be made while driving.

- 1 Button for:
 - ▷ Selecting display
 - ▷ Setting values
- 2 Button for:
 - ▷ Confirming selected display or set values
 - ▷ Calling up computer information 72
- 3 When the lights are on: instrument lighting brightness 95
- 4 Calling up Check Control 77
- 5 Checking engine oil level* 145
- 6 Initializing the Flat Tire Monitor 83
Resetting the Tire Pressure Monitor 85
- 7 Setting the time 77
- 8 Setting the date 77
- 9 Viewing service requirement display 76
- 10 Setting formats and units of measure, resetting to factory settings 75

11 Adjusting settings

- ▷ Confirmation signals when locking and unlocking the vehicle 21
- ▷ Response during unlocking procedure 19
- ▷ Automatic locking 23
- ▷ Pathway lighting 91
- ▷ Daytime running lights 92
- ▷ Triple turn signal activation 60
- ▷ Seat memory* 42

Exiting displays

The outside temperature reading and the time reappear when you press button 2 or if you make no entries within approx. 15 seconds. If required, complete the current setting first.

Formats and units of measure

You can set formats and units of measure.

1. Switch on the ignition, refer to page 50.
2. Lightly push button **1** in the turn indicator lever up or down repeatedly until the symbol appears in the display accompanied by the word "SET".



3. Press button **2**.
4. Use button **1** to select desired format or desired unit of measure, e.g. for fuel consumption.



- ▷ Fuel consumption: mpg, km/l, l/100km
- ▷ I → | Distance covered: mls, km
- ▷ ⌚ Time: 12h, 24h format
- ▷ 📅 Date: day.month dd.mm, month/day mm/dd
- ▷ 🌡 Temperature: °F, °C

5. Press button **2**.
6. Use button **1** to make the setting.
7. Press button **2**.
The setting is stored for the remote control currently in use.

Resetting to factory settings

You can reset the settings for formats and units of measure to the factory settings.

1. Lightly push button **1** in the turn indicator lever up or down repeatedly until the symbol appears in the display accompanied by the word "SET".



2. Press button **2**.
3. Use button **1** to select "RESET".



4. Press button **2** until  is displayed. The settings are reset. The setting is stored for the remote control currently in use.

Service requirements



The remaining driving distance and the date of the next scheduled service are displayed briefly immediately after you start the engine or switch on the ignition.

 The extent of service work required can be read out from the remote control by your BMW Service Advisor. ◀

For certain maintenance operations, you can view the respective distance remaining or due date individually in the instrument cluster.



1. Switch on the ignition, refer to page 50.
2. Push button 1 in the turn indicator lever up or down repeatedly until the appropriate symbol appears in the display, accompanied by the words "SERVICE-INFO".
3. Press button 2.
4. Use button 1 to scroll through the individual service items.

Possible displays



- 1 Button for selecting functions
- 2 Service requirements
- 3 Engine oil
- 4 Roadworthiness test*
- 5 Front brake pads

- 6 Rear brake pads
- 7 Brake fluid

The sequence of displayed service items may vary. The data for the next service appointment is shown first.

Clock

Setting the time

To set the 12h/24h mode, refer to Formats and units of measure on page 75.



1. Push button **1** in the turn indicator lever up or down repeatedly until the appropriate symbol appears in the display, accompanied by the time and the word "SET".
2. Press button **2**.
3. Use button **1** to set the hours.
4. Press button **2** to confirm the entry.
5. Use button **1** to set the minutes.
6. Press button **2** to confirm the entry.
7. Press button **2**.
The system accepts the new time.

Date

Setting the date

To set the dd/mm or mm/dd date format, refer to Formats and units of measure on page 75.



1. Push button **1** in the turn indicator lever up or down repeatedly until the appropriate symbol appears in the display, accompanied by the date and the word "SET".

2. Press button **2**.
3. Use button **1** to set the day of the month.
4. Press button **2** to confirm the entry.
5. Set the month and the year in the same way.
6. Press button **2**.
The system stores the new date.

Check Control

The concept

The Check Control monitors vehicle functions and alerts you to any malfunctions in the systems monitored. This type of Check Control message includes indicator and warning lamps in the instrument cluster and, in some cases, an acoustic signal.



Indicator and warning lamps can light up in a variety of combinations and colors.

Several of the lamps are checked for proper functioning and light up temporarily when the engine is started or the ignition is switched on.



A indicates that Check Control messages have been stored. These Check Control messages can be viewed again later, refer to page 78.

What to do in case of a malfunction

The meaning of each lamp in the event of a malfunction and tips on how to respond are listed starting on page 164.

Hiding Check Control messages

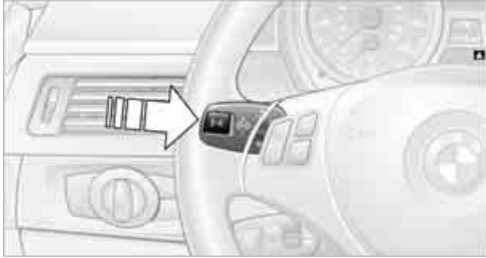

Press the button on the turn indicator lever.

- ▷ Some Check Control messages are displayed continuously and remain visible until the malfunction has been rectified. If several malfunctions occur at once, the messages are displayed consecutively. These messages can be hidden for approx. 8 seconds. After this, they are displayed again automatically.
- ▷ Other Check Control messages are hidden automatically after approx. 20 seconds. They are stored and can be displayed again later.

Displaying stored Check Control messages



1. Push button **1** in the turn indicator lever up or down repeatedly until the appropriate symbol appears in the display, accompanied by the words "CHECK CONTROL".
2. Press button **2**. "CHECK OK" appears if there are no Check Control messages. If a Check Control message has been stored, the corresponding lamp comes on.
3. Push button **1** to check for other messages.
4. Press button **2**. The display again shows the outside temperature and the time.

Technology for driving comfort and safety

Park Distance Control PDC*

The concept

The PDC assists you with maneuvering in tight parking spaces. Acoustic signals warn you of the presence of an object in front of* or behind your vehicle. To measure the distance, there are four ultrasonic sensors in either bumper.

An acoustic warning sounds when the sensors at the front* and at the two rear corners are less than approx. 24 in/60 cm away from the object and the middle rear sensors are approx. 5 ft/1.50 m away from it.

 PDC is a parking aid that can indicate objects when they are approached slowly, as is usually the case when parking. Avoid approaching an object at high speed; otherwise, physical circumstances may lead to the system warning being issued too late. ◀

Switching on automatically

With the engine running or the ignition switched on, the system is activated after approx. one second when you shift into reverse or move the automatic transmission selector lever to position R. Wait this short period before driving.

Switching off automatically

After approx. 55 yd/50 m of driving or above approx. 20 mph/approx. 30 km/h, the system switches off and the LED goes out.

Switching on manually*



Press the button; the LED lights up.

Switching off manually*

Press the button again; the LED goes out.

Signal tones

When nearing an object, its position is indicated correspondingly by an interval tone. For example, if an object is detected behind the vehicle, the signal tone sounds from the rear. As the distance between vehicle and object decreases, the intervals between the tones become shorter. If the distance to the nearest object falls to below roughly 1 ft/30 cm, then a continuous tone sounds.

An interval tone is interrupted after approx. 3 seconds

- ▷ If you remain in front of an object that has been detected by only one of the corner sensors
- ▷ If you are driving parallel to a wall.

Malfunction



The indicator lamp in the instrument cluster comes on. PDC is malfunctioning. Have the system checked.

To avoid this problem, keep the sensors clean and free of ice or snow in order to ensure that they will continue to operate effectively. When using a high-pressure cleaner, do not spray the sensors for extended periods of time and only from a distance of at least 1 ft/30 cm.

Manual operation*

The LED above the button also flashes.

System limitations

 Even with PDC, final responsibility for estimating the distance between the vehicle and any obstructions always remains with the driver. Even when sensors are provided, there is a blind spot in which objects can no longer be detected. The system is also subject to the physical limits that apply to all forms of ultrasonic measurement, such as those encountered with trailer towbars and hitches, thin or wedge-shaped objects, etc. Low objects that have already been displayed, e.g. curbs, can disappear again from the detection area of the sensors before or after a continuous tone sounds. Higher, protruding objects, e.g. ledges, cannot be detected. Therefore, always drive cautiously; otherwise, there is a risk of personal injury or property damage. Loud sound sources outside or inside the car can drown out the PDC signal. Therefore, always drive cautiously; otherwise, there is a risk of personal injury or property damage. ◀

Driving stability control systems

Your BMW has a number of systems that help to maintain the vehicle's stability even in adverse driving conditions.

Antilock Brake System ABS

ABS prevents locking of the wheels during braking. Safe steering response is maintained even during full braking. Active safety is thus increased.

The ABS is operational every time you start the engine. Braking safely, refer to page [122](#).

Electronic brake-force distribution EBV

The system controls the brake pressure in the rear wheels to ensure stable braking behavior.

Dynamic Brake Control DBC

When you apply the brakes rapidly, this system automatically produces the maximum braking force boost and thus helps to achieve the shortest possible braking distance during full braking. This system exploits all of the benefits provided by ABS.

Do not reduce the pressure on the brake for the duration of the full braking application.

Dynamic Stability Control DSC

DSC prevents the driving wheels from losing traction when you pull away from rest or accelerate. The system also recognizes unstable driving conditions, for example if the rear of the car is about to swerve or if momentum is acting at an angle past the front wheels. In these cases, DSC helps the vehicle maintain a safe course within physical limits by reducing engine output and through braking actions at the individual wheels.

 The laws of physics cannot be repealed, even with DSC. An appropriate driving style always remains the responsibility of the driver. Therefore, do not reduce the additional safety margin again by taking risks, as this could result in an accident. ◀

Deactivating DSC

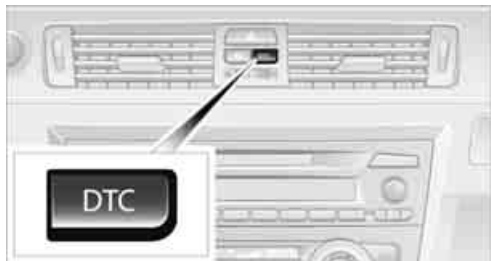

Press the button for at least 3 seconds; the indicator lamps for DSC in the instrument cluster light up. Dynamic Traction Control DTC and DSC have been simultaneously deactivated. Stabilizing and drive-output promoting actions are no longer executed.

In the same way as with a differential interlock*, even if DSC is deactivated, brake actions are still performed to enhance drive output if the drive wheels experience a significant loss of traction.

To increase vehicle stability, activate DSC again as soon as possible.

Activating DSC

Press the button again; the indicator lamps in the instrument cluster go out.

For better control



If the indicator lamp flashes:
DSC is regulating the drive and braking forces.



If the indicator lamps are on:
DSC is deactivated.



Dynamic Traction Control DTC

DTC is a version of DSC in which the drive output is optimized for particular road conditions, e.g. unplowed snow-covered roads. The system assures the maximal drive output, but with reduced driving stability. It is therefore necessary to drive with appropriate caution.

You may find it useful to briefly activate DTC under the following special circumstances:

- ▶ When driving uphill on snow-covered roads, in slush or on unplowed, snow-covered roads
- ▶ When rocking a stuck vehicle free or starting off in deep snow or on loose ground
- ▶ When driving with snow chains

Activating DTC

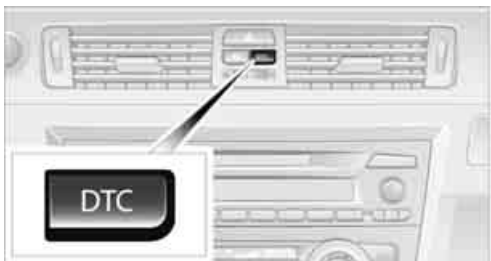

Press the button; the indicator lamps for DTC in the instrument cluster come on.

For better control



If the indicator lamp flashes:
DTC is regulating the drive and braking forces.



If the indicator lamps are on:
DTC has been activated.

Deactivating DTC

Press the button again; the DTC indicator lamps in the instrument cluster go out.

xDrive*

xDrive is your BMW's four-wheel-drive system. The combined efforts of xDrive and DSC help to further optimize traction and driving dynamics. The xDrive four-wheel-drive system distributes driving power variably to the front and rear axles depending on the driving situation and road conditions.

Hill Descent Control HDC*

HDC is a downhill driving assistant that controls your speed on steep downhill gradients and makes it even easier to control your BMW's handling under these conditions. The vehicle then moves slightly faster than double walking speed without the driver needing to intervene.

HDC can be activated as long as you are driving under approx. 20 mph or 35 km/h. When driving downhill at a speed of under approx. 20 mph or 35 km/h, the vehicle's speed is automatically reduced to slightly more than double walking speed and maintained.

Increasing or decreasing speed

By accelerating or braking you can change this speed within a range from approx. 3 to 15 mph, approx. 5 to 25 km/h.

You can specify a target speed within the same range using the cruise control* lever on the steering column.

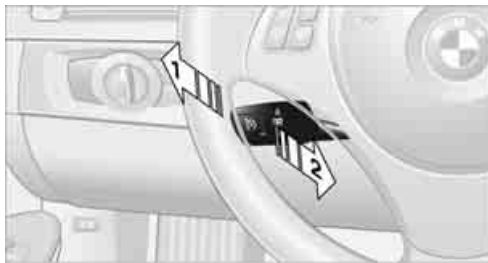

- 1 To increase speed
- 2 To decrease speed

Activating HDC



Press the button; the LED lights up. When the vehicle is being braked automatically, the LED flashes.

Deactivating HDC

Press the button again; the LED goes out.

HDC is automatically deactivated at speeds greater than approx. 35 mph/60 km/h.

Using HDC

In cars with manual transmission:

Use HDC in lower gears and in reverse gear.

With automatic transmission:

You can use HDC in any drive position.

Displays in the instrument cluster*



- 1 Display for target speed
- 2 HDC display

Malfunction

The HDC display disappears during HDC operation, or does not appear:

HDC is temporarily unavailable due to excessive brake temperature, or DSC has failed.

Drive-off assistant

The drive-off assistant enables you to drive off smoothly on uphill gradients. It is not necessary to use the parking brake for this.

- 1. Hold the car in place by depressing the brake.
- 2. Release the brake and drive off without delay.



The drive-off assistant holds the car in place for approx. 2 seconds after the brake is released. Drive off without delay after releasing the brake. Otherwise, the drive-off assistant will no longer hold the car in place

after approx. 2 seconds and the car will start to roll backwards. ◀

Flat Tire Monitor FTM*

The concept

The system does not measure the actual inflation pressure in the tires.

The system detects a tire pressure loss due to speed comparisons among the individual wheels as you drive.

In the event of pressure loss, the rolling circumference changes and, thus, the rotating speed of the affected wheel. The system detects this and reports it as a flat tire.

Functional requirement

The system has to have been initialized at the correct inflation pressure; otherwise, a reliable reporting of a flat tire is not assured.

Each time a tire inflation pressure has been corrected or a wheel or tire has been changed, reinitialize the system.

System limitations

 It is impossible to provide advance warning of sudden, severe tire damage caused by outside influences. ◀

The system will not detect a natural, uniform pressure loss in all four tires. Therefore you should check the inflation pressure regularly.

In the following situations, the system could be delayed or malfunction:

- ▷ System has not been initialized
- ▷ Driving on snowy or slippery road surface
- ▷ Performance-oriented style of driving: slip in the drive wheels, high lateral acceleration
- ▷ Driving with snow chains*

Initialization

In the initialization, the set inflation pressures are adopted as reference values for the detection of a flat tire. The initialization is begun by confirmation of the inflation pressures.

Do not initialize the system while snow chains are attached.

For operating principle refer to page 74.

1. Start the engine immediately before pulling away, but do not drive off yet.



2. Lightly push button 1 in the turn indicator lever up or down repeatedly until the corresponding symbol appears in the display accompanied by the word "RESET".
3. Press button 2 to confirm your choice of the Flat Tire Monitor.
4. Press button 2 for approx. 5 seconds, until the reading shown below is displayed:



5. Start driving.
Initialization is completed while the car is on the move, without any feedback.

 The initialization is completed during driving, which can be interrupted at any time. When driving resumes, the initialization is continued automatically. ◀

Indication of a flat tire



The warning lamps come on in yellow and red. In addition, an acoustic signal sounds. There is a flat tire or substantial loss of tire pressure.

What to do in case of a flat tire

Run-flat tires

With a damaged tire, it is possible to continue driving at speeds of up to 50 mph/80 km/h.



Do not continue driving if the vehicle is not equipped with run-flat tires, refer to page 142; continued driving could result in a severe accident. ◀

When continuing to drive with a damaged tire:

1. Avoid sudden braking and steering maneuvers.
2. Do not exceed a speed of 50 mph/80 km/h.
3. At the next opportunity, check the air pressure in all four tires.



If all four tires are inflated to the correct pressures, the Flat Tire Monitor might not have been initialized. The system must then be initialized. ◀

Possible travel distance with complete tire pressure loss:

- ▷ With a light load:
1 to 2 persons without luggage:
Approx. 155 miles/250 km
- ▷ With a medium load:
2 persons, cargo area full, or 4 persons without luggage:
Approx. 94 miles/150 km
- ▷ With a full load:
4 persons, cargo area full:
Approx. 30 miles/50 km



Drive cautiously and do not exceed a speed of 50 mph/80 km/h.

When there is a tire pressure loss, the handling characteristics change, e.g. there will be reduced directional stability during braking, braking distances will be longer, and self-steering response will change. ◀



Vibrations or loud noises during driving may indicate the final failure of the tire. Reduce your speed and bring the vehicle to a stop; otherwise, tire components may become detached, which could result in an accident. Do not continue driving; instead, contact your BMW center. ◀

Tire Pressure Monitor TPM*

The concept

Check the inflation pressure in the four installed tires. The system notifies you if there is a significant loss of pressure in one or more tires.

Functional requirement

The system has to have been reset at the correct inflation pressure; otherwise, a reliable reporting of a flat tire is not assured.

Always use wheels with TPM electronics to assure a trouble-free function of the system.



Each time a tire inflation pressure has been corrected or a wheel or tire has been changed, reset the system. ◀

System limitations



It is impossible to provide advance warning of sudden, severe tire damage caused by outside influences. ◀

The system does not function correctly if it has not been reset. For example, a flat tire may be indicated even though the tire inflation pressures are correct.

The system is inactive and cannot indicate a flat tire:

- ▷ when a wheel without TPM electronics is installed.
- ▷ when other systems or devices that use the same radio frequency interfere with TPM.

Resetting the system

Each time a tire inflation pressure has been corrected or a wheel or tire has been changed, reset the system.

For operating principle refer to page 74.

1. Start the engine, but do not start driving.
2. Lightly push button **1** in the turn indicator lever up or down repeatedly until the corresponding symbol appears in the display accompanied by the word "RESET".



3. Press button **2** to confirm your choice of the Tire Pressure Monitor. The following display appears:



4. Press button **2** for approx. 5 seconds, until the reading shown below is displayed:



5. Start driving.

After several minutes of driving time, the adjusted inflation pressures will be adopted as nominal values. The resetting is completed automatically as you drive. The indicator lamp goes out after the system reset is completed.

You can stop driving at any time. The resetting continues automatically when you resume driving.

Message for low tire inflation pressure



The warning lamps come on in yellow and red. In addition, a signal sounds.



▷ There is a flat tire or substantial loss of tire pressure.

- ▷ The system was not reset after a wheel change and will thus issue warnings at the last initialized inflation pressures.

Cautiously reduce speed to below 50 mph/80 km/h. Avoid sudden braking and steering maneuvers. Do not exceed a speed of 50 mph/80 km/h.



Do not continue driving if the vehicle is not equipped with run-flat tires, refer to page 142; continued driving could result in a severe accident. ◀

Continuing to drive with a flat tire

Possible travel distance with complete tire pressure loss:

- ▷ With a light load:
1 to 2 persons without luggage:
Approx. 155 miles/250 km
- ▷ With a medium load:
2 persons, cargo area full, or 4 persons without luggage:
Approx. 95 miles/150 km
- ▷ With a full load:
4 persons, cargo area full:
Approx. 30 miles/50 km



Drive cautiously and do not exceed a speed of 50 mph/80 km/h.

When there is a tire pressure loss, the handling characteristics change, e.g. there will be reduced directional stability during braking, braking distances will be longer, and self-steering response will change. ◀



Vibrations or loud noises during driving may indicate the final failure of the tire. Reduce your speed and bring the vehicle to a stop; otherwise, tire components may become detached, which could result in an accident. Do not continue driving; instead, contact your BMW center. ◀

Malfuction



The small warning lamp flashes in yellow and then lights up continuously; the large warning lamp comes on in yellow. No punctures can be detected.

Display in the following situations:

- ▷ Malfuction
Have the system checked.
- ▷ A wheel without TPM electronics has been installed:
Have it checked by your BMW center.
- ▷ Interference from systems or devices that use the same radio frequency:
The system automatically becomes active again when the vehicle moves out of the interference zone.

Declaration according to NHTSA/ FMVSS 138 Tire Pressure Monitoring Systems

Each tire should be checked monthly when cold and inflated to the inflation pressure recommended by the vehicle manufacturer on the vehicle placard or tire inflation pressure label. If your vehicle has tires of a different size than the size indicated on the vehicle placard or tire inflation pressure label, you should determine the proper tire inflation pressure for those tires. As an added safety feature, your vehicle has been equipped with a tire pressure monitoring system, TPMS, that illuminates a low tire pressure telltale when one or more of your tires are significantly underinflated. Accordingly, when the low tire pressure telltale illuminates, you should stop and check your tires as soon as possible, and inflate them to the proper pressure. Driving on a significantly underinflated tire causes the tire to overheat and can lead to tire failure.

Underinflation also reduces fuel efficiency and tire tread life, and may affect the vehicle's handling and stopping ability. Please note that the TPMS is not a substitute for proper tire maintenance, and it is the driver's responsibility to maintain correct tire pressure, even if underinflation has not reached the level at which the TPMS low tire pressure telltale illuminates.

The TPMS malfuction indicator is combined with the low tire pressure telltale. When the system detects a malfuction, the telltale will flash for approximately one minute and then remain continuously lit. This sequence will continue upon subsequent vehicle startups as long as the malfuction exists. When the malfuction indicator is illuminated, the system may not be able to detect or signal low tire pressure as intended. TPMS malfuctions may occur for a variety of reasons, including the installation of replacement or alternate tires or wheels on the vehicle that prevent the TPMS from functioning properly. Always check the TPMS malfuction telltale after replacing one or more tires or wheels on your vehicle to ensure that the replacement or alternate tires and wheels allow the TPMS to continue to function properly.

Active steering*

The concept

Active steering varies the turning angle of the front wheels in relation to steering wheel movements. It also varies the steering force required to turn the wheels depending on the speed at which you are driving.

When you are driving in the low road speed range, e.g. in a town or when parking, the steering angle is increased, i.e. steering becomes very direct and less effort is required to turn the wheels. In the higher speed range, on the other hand, the steering angle is reduced as the speed increases. This improves the handling of your BMW over the entire speed range.

In critical situations, the system can make targeted corrections to the steering angle provided by the driver and thus stabilize the vehicle before the driver intervenes. This stabilizing intervention is simultaneously deactivated when DSC is switched off, refer to page 81.

Malfunction



The warning lamps come on. Active steering is malfunctioning or is temporarily deactivated. At low speeds, greater steering wheel movements are required, whereas at higher speeds the vehicle reacts more sensitively to steering wheel movements. The stability-enhancing feature may also be deactivated. Drive cautiously and think well ahead.

Deactivation

Active steering is deactivated to perform an initialization. A message indicates that the feature is deactivated. Initialization may take several minutes.

If the message does not disappear during the current trip, have the system checked.

Defect

If there is a defect, a corresponding message appears. Have the system checked.

Servotronic*

The concept

The Servotronic varies the steering force required to turn the wheels relative to the vehicle speed.

At low speeds, the steering force is strongly assisted, i.e. less force is needed for steering. As the vehicle speed increases, the steering assisting power is reduced.

Malfunction

Malfunctions are displayed via Check Control, refer to page 77.

Brake Force Display



On the left: normal braking.

On the right: sharp braking.

Airbags



The following airbags are located under the marked covers:

- 1 Front airbags
- 2 Coupe: head airbags
- 3 Side airbags in the seat backrests
- 4 Convertible: knee airbags

Protective action

 Observe the adjustment instructions on page 36 to ensure the best possible personal protection. ◀

The front airbags help protect the driver and front passenger by responding to frontal impacts in which safety belts alone cannot provide adequate restraint. When needed, the head and side airbags help provide protection in the event of side impact. The relevant side airbag supports the side upper body area. The head air bag supports the head.

The airbags have been designed to not be triggered in every collision situation, e.g. not in minor accidents or rear-end collisions.

 Do not apply adhesive materials to the cover panels of the airbags, cover them or modify them in any other way.

Keep the dashboard and windows on the front passenger side clear, i.e. do not cover with adhesive labels or coverings, and do not attach holders such as for navigation instruments or mobile phones.

Do not attach seat covers, cushions or other objects not specifically approved for seats with integral side airbags to the front seats. Do not hang items of clothing such as coats or jackets over the backrests. Do not attempt to remove

the airbag retention system from the vehicle. Do not modify the individual components of the system or its wiring in any way. This includes the upholstered covers on the steering wheel, instrument panel, seats and roof posts, as well as the sides of the roof lining. Do not attempt to remove or dismantle the steering wheel.

Do not touch the individual components immediately after the system has been triggered, because there is a danger of burns.

In the event of malfunctions, deactivation or triggering of the airbag restraint system, have the testing, repair, removal and disposal of airbag generators executed only by a BMW center or a workshop that works according to repair procedures of BMW with correspondingly trained personnel and that has the required explosives licenses. Unprofessional attempts to work on the system could lead to failure in an emergency or to undesired airbag activation, either of which could result in personal injury. ◀

Warning notices and information about the airbags can also be found on the sun visors.

Automatic deactivation of the front passenger airbags

An analysis of the impression in the front passenger seat cushion determines whether and how the seat is occupied. The front and side airbags for the front passenger are activated or deactivated by the system accordingly.

 The indicator lamp above the interior rearview mirror shows the current status of the front passenger airbags, deactivated or activated, refer to Status of front passenger airbags below. ◀

⚠ Before transporting a child on the front passenger seat, read the safety precautions and handling instructions under Transporting children safely, refer to page 47. The front and side airbags can also be deactivated by adolescents and adults sitting in certain positions; the indicator lamp for the front passenger airbags comes on. In such cases, the passenger should change his or her sitting position so that the front passenger airbags are activated and the indicator lamp goes out. If the desired airbag status cannot be achieved by changing the sitting position, transport the relevant passenger on a rear seat. Do not attach seat covers, seat cushion padding, ball mats or other items to the front passenger seat unless they are specifically recommended by BMW. Do not place any items under the seat which could press against the seat from below. Otherwise, a correct analysis of the seat cushion is not ensured. ◀

Status of front passenger airbags



The indicator lamp for the front passenger airbags shows the functional status of the front passenger front and side airbags in accordance with whether and how the front passenger seat is occupied. The indicator lamp shows whether the front passenger airbags are activated or deactivated.

- ▷ The indicator lamp lights up when a child in a specially designated child restraint system is detected, as intended, on the seat. The front and side airbags for the front passenger are not activated.

▶ Most child seats are detected by the system, especially child seats required by the NHTSA at the time of vehicle production. After mounting a child seat, ensure that the indicator lamp for the front passenger airbag is lit. It indicates that the child seat has been detected and that the front passenger airbags are deactivated. ◀

- ▷ The indicator lamp does not come on as long as a person of sufficient size and in a correct sitting position is detected on the seat. The front and side airbags for the front passenger are activated.
- ▷ The indicator lamp does not come on if the seat is empty. The front and side airbags for the front passenger are not activated.

Operational readiness of airbag system



As of radio readiness, refer to page 50, the warning lamp comes on briefly to indicate that the entire airbag system and the belt tensioners are operational.

Airbag system malfunction

- ▷ Warning lamp does not light up at radio readiness or beyond.
 - ▷ Warning lamp remains permanently on.
- ⚠** In the event of a fault in the airbag system, have it checked without delay; otherwise, there is the risk that the system will not function as intended even if a sufficiently severe accident occurs. ◀

Convertible: rollover protection system

The rollover protection system is activated automatically in the event of an accident, a critical driving situation, an extreme tilt in the car's longitudinal axis or upon loss of ground contact. The protection bars behind the rear head restraints deploy within fractions of a second.

As a supplementary system to the reinforced windshield frame, the rollover protection system ensures that the necessary headroom is maintained for all vehicle occupants.

 Always keep the area of movement of the rollover protection system clear. In minor accidents, you are protected by the fastened safety belt and, depending on accident severity, by the safety belt tensioner and multi-phase airbag retention system. ◀

Resetting

If the rollover protection system was not impacted after being automatically activated, it can be reset by lowering the protection bars to their original positions. This does not require tools.

1. Push the locking lever to one side and hold it there.

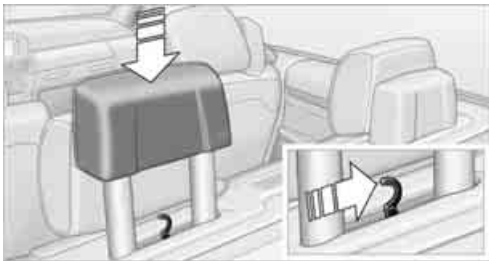

2. Push the protection bar halfway down from above.
3. Release the locking lever.

4. Push the protection bar down until it snaps into place.

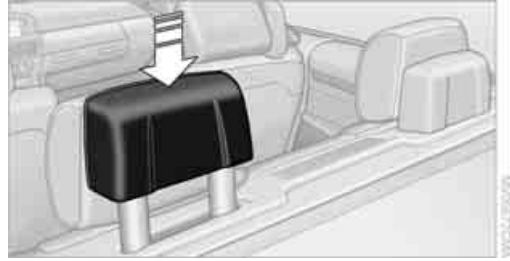

5. Repeat the procedure for the other protection bar.

Have the rollover protection system checked after an unexpected activation.

 Never move the retractable hardtop when the rollover protection system is in the activated position.

Do not make any modifications to the individual components of the rollover protection system or its cabling.

Work on the rollover protection system should only be performed by a BMW center. Incorrectly performed work on the system may lead to system failure or incorrect operation.

To check the system and ensure flawless long-term operation, always observe the service intervals, refer to page 76. ◀

Lamps

Parking lamps/low beams

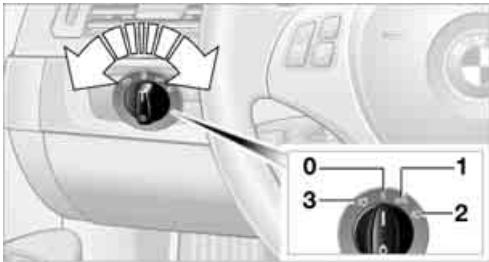

- 0 Lamps off, daytime running lights
- 1 Parking lamps and daytime running lights
- 2 Low-beam headlamps and welcome lamps
- 3 Automatic headlamp control*, daytime running lights, welcome lamps, high-beam assistant* and adaptive light control*

When you open the driver's door with the ignition switched off, the exterior lighting is automatically switched off if the light switch is in position **0**, **2** or **3**.

Switch on the parking lamps if necessary, switch position **1**.

Parking lamps

In switch position **1**, the front, rear and side vehicle lighting is switched on. You can use the parking lamps for parking.

 The parking lamps will discharge the battery. Therefore, do not leave them on for unduly long periods of time; otherwise, the battery might not have enough power to start the engine. It is preferable to switch on the left-hand or right-hand roadside parking lamps, refer to page [93](#).

Low beams

The low beams light up when the light switch is in position **2** and the ignition is on.

Automatic headlamp control*

When the switch is in position **3**, the low beams are switched on and off automatically depending on ambient light conditions, e.g. in a tunnel, in twilight, or if there is precipitation. The adaptive light control* is active. The LED next to the symbol is illuminated when the low beams are on. You can also activate the daytime running lights, refer to page [92](#). In the situations described above, the lamps then automatically switch from daytime running lights to low beams.

The headlamps may also come on when the sun is sitting low on a blue sky.

 The low beams remain switched on regardless of the ambient lighting conditions when you switch on the fog lamps.

 The automatic headlamp control cannot serve as a substitute for your personal judgment in determining when the lamps should be switched on in response to ambient lighting conditions. For example, the system cannot detect fog or hazy weather. To avoid safety risks, you should always switch on the low-beam headlamps manually under these conditions.

Welcome lamps

If you leave the light switch in position **2** or **3** when you park the car, the parking lamps and the interior lamps light up briefly when you unlock the vehicle.

Pathway lighting

If you activate the headlamp flasher after switching off the ignition with the lamps switched off, the low beams come on and remain on for a certain time.

Setting the duration or deactivating

For operating principle, refer to page 74.

1. Switch on the ignition, refer to page 50.
2. Lightly push button **1** in the turn indicator lever up or down repeatedly until the symbol appears in the display accompanied by the word "SET".



3. Press button **2**.
4. Lightly push button **1** in the turn indicator lever down repeatedly until the symbol appears in the display.



5. Press button **2**.
6. Use button **1** to select:
 - ▷ **0 s**
The function is deactivated.
 - ▷ **10 s ... 240 s**
Select the corresponding duration, e.g. 40 seconds.
7. Press button **2**.
The setting is stored for the remote control currently in use.

Daytime running lights

The daytime running lights light up in switch position **0**, **1** and **3**. They are less powerful than the low beams.

Activating/deactivating daytime running lights

For operating principle, refer to page 74.

1. Switch on the ignition, refer to page 50.
2. Lightly push button **1** in the turn indicator lever up or down repeatedly until the symbol appears in the display accompanied by the word "SET".



3. Press button **2**.
4. Lightly push button **1** in the turn indicator lever down repeatedly until the symbol appears in the display.



5. Press button **2**.
6. Use button **1** to select:
 - ▷ **on**
Daytime running lights activated.
 - ▷ **off**
Daytime running lights deactivated.
7. Press button **2**.
The setting is stored for the remote control currently in use.

Adaptive light control*

The concept

Adaptive light control is a variable headlamp control system that enables better illumination of the road surface. Depending on the steering angle and other parameters, the light from the headlamp follows the course of the road.

In tight curves at speeds up to 40 mph/70 km/h, e.g. on mountainous roads or when turning, an additional, corner-illuminating lamp is switched on that lights up the inside area of the curve.

Activating Adaptive Light Control

With the ignition switched on, turn the light switch to position **3**, refer to page 91.

The corner-illuminating lamp is switched on automatically, depending on the steering wheel angle or turn signal indicator.

Standstill function*: to avoid blinding oncoming traffic, the adaptive light control directs light towards the front passenger side when the vehicle is at a standstill.

When you are reversing, only the corner-illuminating lamps are switched on and active on both sides.

Malfunction

The LED next to the symbol for automatic headlamp control flashes. Adaptive light control is malfunctioning or has failed. Have the system checked as soon as possible.

High beams/roadside parking lamps

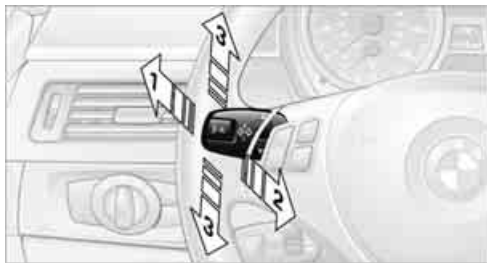

- 1 High beams
- 2 Headlamp flasher
- 3 Roadside parking lamps*

Roadside parking lamps, left or right*

There is an additional option of switching on the lamps on the side of the car facing the road when parked.

Switching on

After parking the vehicle, press the lever up or down beyond the pressure point for a longer period, arrow **3**.

 The roadside parking lamps drain the battery. Therefore, do not leave them on for unduly long periods of time; otherwise, the battery might not have enough power to start the engine. ◀

Switching off

Press the lever in the opposite direction to the pressure point, arrow **3**.

High-beam assistant*

The concept

This system automatically switches the high beams on and off. The procedure is controlled by a sensor on the front of the interior rearview mirror. The assistant ensures that the high beams are switched on whenever the traffic situation allows. It handles this task for you and gives you the benefit of the best possible view. You can intervene at any time and switch the high beams on and off as usual.

Activating the system

1. Turn the light switch to position **3**, refer to page 91.
2. With the low beams switched on, briefly push the turn indicator lever in the direction of the high beam.



The indicator lamp in the instrument cluster lights up when the high beams are activated. The system automatically switches from high beams to low beams and vice versa in response to oncoming traffic, traffic ahead of you, and adequate ambient lighting, e.g. on city streets.

Switching the high beams on and off manually

Whenever you wish, or when the situation requires, you can intervene:

- ▷ If the high-beam assistant switches on the high beams, but you would like to drive with the low beams, simply switch off the high beams using the turn indicator lever. This deactivates the high-beam assistant. To reactivate the system, briefly push the turn indicator lever toward the high beams again.
- ▷ Use the headlamp flasher as usual with the low beams switched on.

System limitations



The high-beam assistant cannot serve as a substitute for the driver's personal judgment of when to use the high beams. Therefore, manually switch off the high beams in situations where this is required to avoid a safety risk. ◀

The system is not fully functional in situations such as the following, and driver intervention may be necessary:

- ▷ In very unfavorable weather conditions, such as fog or heavy precipitation
- ▷ In detecting poorly-lit road users, such as pedestrians, cyclists, horseback riders and wagons; when driving close to train or ship traffic; and at animal crossings
- ▷ In tight curves, on hilltops or in depressions, in cross traffic or half-observed oncoming traffic on highways
- ▷ In poorly lit towns and cities and in the presence of highly reflective signs
- ▷ At low speeds
- ▷ When the windshield in front of the interior rearview mirror is fogged over, dirty or covered with stickers, etc.
- ▷ If the sensor is dirty. Clean the sensor on the front of the interior rearview mirror using a cloth moistened with a small amount of glass cleaner.

Fog lamps*



 The parking lamps or low beams must be switched on for the fog lamps to operate. The green indicator lamp in the instrument cluster lights up whenever the fog lamps are on.

The fog lamps are switched off while you activate the headlamp flasher or switch on the high beams.

 If the automatic headlamp control is activated, the low beams will come on automatically when you switch on the fog lamps. ◀

Instrument lighting

You can adjust the brightness of the instrument lighting only when the parking lamps or the low beams are switched on.



1. Push button **1** up or down repeatedly until the appropriate symbol appears in the display, accompanied by the brightness setting and scale the word "SET".
2. Press button **2**.



3. Push button **1** up or down to select the desired brightness level.
4. Press button **2**.
The display again shows the outside temperature and the time.

Interior lamps

The interior lamps, the footwell lamps*, entry lamps*, cargo area lamp and courtesy lamps* are controlled automatically.

The LEDs for the courtesy lamps are set in the door handles and illuminate the ground in front of the doors.

 To avoid draining the battery, all lamps inside the car are switched off about 8 minutes after the ignition is switched off, refer to Start/stop button on page 50. ◀

Switching interior lamps on/off manually



Interior lamps, front and rear*:
To switch on and off, press the button.

To switch off the interior lamps, footwell lamps*, entry lamps* and courtesy lamps* permanently, press the button for the front interior lamps for about 3 seconds.

Reading lamps



There are reading lamps at the front and rear*, next to the interior lamps. To switch on and off, press the button.

Climate



Equipment versions

Depending on the equipment version, your car has an air conditioner or an automatic climate control system.

- 1 Air conditioner [98](#)
- 2 Automatic climate control* [100](#)

Air vents

- 3 Airflow directed toward the windshield and side windows
- 4 Air to the upper body area.
The thumbwheels smoothly open and close the air supply. The levers alter the direction of the airflow. For further details on draft-free ventilation, refer to page [102](#).
- 5 Air to the footwell



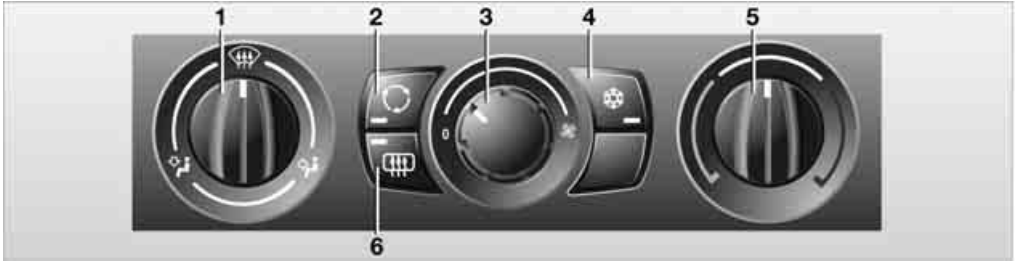

Air conditioner



- | | |
|--|---|
| <p>1 Air distribution</p> <p>2 Recirculated-air mode</p> <p>3 Air volume</p> | <p>4 Cooling function</p> <p>5 Temperature</p> <p>6 Rear window defroster</p> |
|--|---|

Air distribution



Direct the flow of air to the windows , to the upper body area  or to the footwell . Intermediate settings are possible. In the center position between  and , the air is also deflected toward the windows.

Recirculated-air mode



If the air outside the car has an unpleasant odor or contains pollutants, shut off the supply to the interior of the car temporarily. The system then recirculates the air currently within the vehicle.

You can also activate/deactivate the recirculated-air mode by means of a button* on the steering wheel, refer to page 11.

 If condensation starts to form on the inside window surfaces during operation in the recirculated-air mode, you should switch it off while also increasing the air volume as required.

The recirculated-air mode should not be used continuously for lengthy periods; otherwise, the quality of the air inside the car will gradually deteriorate. ◀

Air volume



Turn to adjust the air volume. The higher the volume, the more effective the heating or cooling will be.

The air volume may be reduced or the blower may be switched off entirely to save on battery power.

Switching the system on/off

Set any desired air volume to switch on the air conditioner.

Turn the air volume rotary switch to 0. The blower and air conditioner are completely switched off and the air supply is cut off.

 The outside air supply is blocked when the air conditioner is switched off. If the air quality deteriorates or the window fogs over, switch the system back on and increase the air volume. ◀

Switching cooling function on/off



The cooling function cools and dehumidifies the incoming air before reheating it according to the temperature setting. This function is only available while the engine is running.

The cooling function helps prevent condensation on the windows or removes it quickly.

Depending on the weather, the windshield may fog over briefly when the engine is started.

Rear window defroster



The defroster is switched off automatically after a certain time. Depending on your vehicle's equipment, the upper wires serve as an antenna and are not part of the rear window defroster.

Temperature



To increase the temperature, turn the rotary switch clockwise towards red.

For a lower temperature, turn the rotary switch counterclockwise towards blue.

Defrosting windows and removing condensation

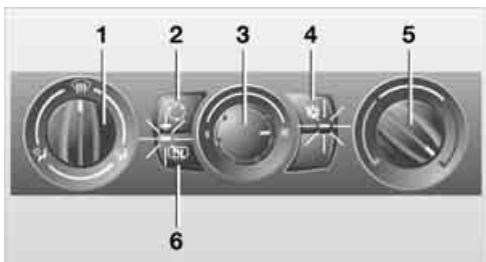

1. Air distribution **1** in position
2. Deactivate recirculated-air mode **2**.
3. Air volume control **3** all the way to the right.
4. Switch on cooling function **4**.
5. Temperature **5** to the right, red.
6. Switch on rear window defroster **6** to defrost the rear window

Ventilation

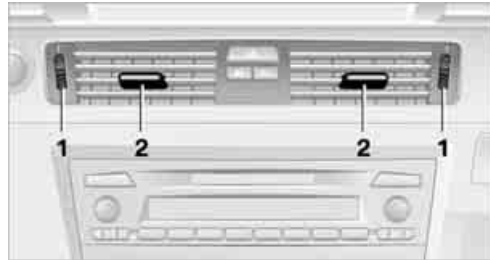

- 1 Use the thumbwheels to smoothly open and close the air vents
- 2 Use the lever to change the direction of the airflow

Ventilation for cooling

Adjust the vent outlets to direct the flow of cool air in your direction, for instance if it has become too hot in the car.

Draft-free ventilation

Adjust the vents to let the air flow past you.

Microfilter

The microfilter removes dust and pollen from the incoming air. The microfilter is changed by your BMW center during routine maintenance work.

Automatic climate control*



- | | |
|---|---|
| <p>1 Seat heating*, left side 41</p> <p>2 Air distribution, manual</p> <p>3 Temperature, left side</p> <p>4 Maximum cooling</p> <p>5 AUTO program</p> <p>6 Air volume, manual adjustment; AUTO intensity</p> <p>7 Automatic recirculated-air control AUC/ Recirculated-air mode</p> | <p>8 ALL program</p> <p>9 Temperature, right side</p> <p>10 Defrosting windows and removing condensation</p> <p>11 Switching cooling function on/off manually</p> <p>12 Rear window defroster</p> <p>13 Seat heating*, right side 41</p> <p>14 Interior temperature sensor, please keep clear</p> |
|---|---|

Comfortable interior climate

AUTO program **5** offers the ideal air distribution and air volume for almost all conditions, refer to AUTO program below. All you need to do is select an interior temperature which is comfortable for you.

The following sections inform you in detail about how to adjust the settings.

Most settings are stored for the remote control currently in use, refer also to Personal Profile settings on page 18.

Adjusting air distribution manually



The air distribution can be switched on and off manually. The air is directed to the windshield, to the upper body area and to the footwell.

The automatic air distribution can be switched back on by pressing the AUTO button. The cooling function is switched on automatically and the manual air distribution setting is cleared.

Temperature



Turn to set the desired temperature.

The automatic climate control achieves this temperature as quickly as possible regardless of the season, using maximum cooling or heating power if necessary, and then maintains it.

Avoid rapid switching between different temperature settings. The automatic climate control will not have sufficient time to adjust the set temperature.

Maximum heating power can be obtained with the highest setting, regardless of the outside temperature.

The system cools steadily in the lowest setting, regardless of the outside temperature.

Maximum cooling



Press the button.

The system is set to the lowest temperature, maximum air volume and recirculated-air mode.

Air flows out of the vent outlets for the upper body region. Open them for this purpose.

Air is cooled as quickly as possible:

- ▷ Above an outside temperature of approx. 32 °F / 0 °C
- ▷ When the engine is running

AUTO program



Press the button.

Air volume, air distribution and temperature are controlled automatically.

Depending on the selected temperature, AUTO intensity and outside influences, the air is directed toward the windshield, the side windows, the upper body and the footwell.

Pressing the AUTO button automatically switches on the cooling function.

At the same time, a condensation sensor controls the program so as to prevent window condensation as much as possible.

The program is switched off when the air distribution is set manually or the button is pressed again.

Intensity of the AUTO program

With the AUTO program switched on, automatic control of the air volume and air distribution can be adjusted:



Press the left side of the button to reduce the intensity. Press the right side of the button to increase it.

The selected intensity is shown on the display of the automatic climate control.

Convertible program

The Convertible program is active when the hardtop is open. In the Convertible program, the automatic climate control is optimized for driving with the hardtop open. In addition, the air volume is increased as vehicle speed increases.



The effectiveness of the Convertible program can be enhanced considerably by installing the wind deflector. ◀

Adjusting air volume manually

To be able to manually adjust the air volume, switch off the AUTO program first.



Press the left side of the button to reduce the air volume. Press the right side of the button to increase it.

The air volume may be reduced or the blower may be switched off entirely to save on battery power. The display remains the same.

Automatic recirculated-air control AUC/Recirculated-air mode

You can respond to unpleasant odors or pollutants in the immediate environment by temporarily suspending the supply of outside air. The system then recirculates the air currently within the vehicle.



Press the button repeatedly to select an operating mode:

- ▷ LED off: outside air flows in continuously.
- ▷ Left-hand LED on, AUC mode: a sensor detects pollutants in the outside air and controls the shut-off automatically.
- ▷ Right-hand LED on, recirculated-air mode: the supply of outside air is permanently shut off. If the windows fog over, switch off recirculated-air mode and increase the air volume, if necessary. Make sure that air can flow onto the windshield.



The recirculated-air mode should not be used over an extended period of time; otherwise, the air quality inside the car will deteriorate continuously. ◀

Via the button on the steering wheel

You can switch quickly between the recirculated-air mode and the previous mode using a button on the steering wheel, refer to page 11.

ALL program



Press the button.

The current temperature setting on the driver's side is transferred to the front passenger side.

If the temperature setting on the driver's side is changed, the temperature on the front passenger side is changed as well.

The program is switched off when the setting is adjusted on the front passenger side or the button is pressed again.

Defrosting windows and removing condensation



Press the button.

Quickly removes ice and condensation from the windshield and

front side windows.

For this purpose, also switch on the cooling function.

Switching cooling function on/off

The passenger compartment can only be cooled while the engine is running.



Press the button.

The air is cooled and dehumidified and – depending on the temperature setting – warmed again.

Depending on the weather, the windshield may fog up briefly when the engine is started.

Pressing the AUTO button automatically switches on the cooling function.

Rear window defroster



Press the button.

The defroster is switched off automatically after a certain time.

Depending on your vehicle's equipment, the upper wires serve as an antenna and are not part of the rear window defroster.

Switching the system on/off

Switching off



With the blower at its lowest setting, press the left side of the button to switch off the automatic climate control.

All displays are cleared except for the rear window defroster if it is switched on.



The outside air supply is blocked when the automatic climate control is switched off. If the air quality deteriorates or the window fogs over, switch the system back on and increase the air volume. ◀

Switching on

Press any button except the ALL or the rear window defroster button to reactivate the automatic climate control.

Ventilation

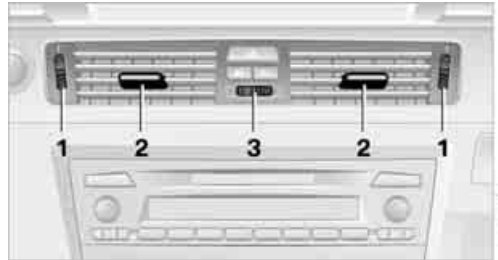

- 1 Use the thumbwheels to smoothly open and close the air vents
- 2 Use the lever to change the direction of the airflow
- 3 Thumbwheel for more or less cool air from the vents for the upper body area

Ventilation for cooling

Adjust the vent outlets to direct the flow of cool air in your direction, for instance if it has become too hot in the car.

Draft-free ventilation

Set the vent outlets so that the air flows past you and not straight at you.

Ventilation in the rear

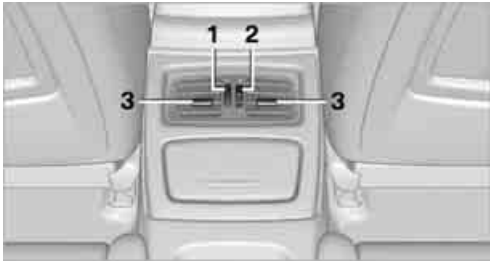

- 1 Use the thumbwheel to adjust the temperature:
 - ▷ Turn toward blue: colder
 - ▷ Turn toward red: warmer
- 2 Use the thumbwheel to smoothly open and close the air vents
- 3 Use the lever to change the direction of the airflow

Microfilter/activated-charcoal filter

The microfilter traps dust and pollen in the incoming air. The activated-charcoal filter provides additional protection by filtering gaseous pollutants from the outside air. Your BMW center replaces this combined filter during routine maintenance.

Practical interior accessories

Integrated universal remote control*

The concept

The integrated universal remote control can replace as many as three hand-held transmitters for various remote-controlled devices, such as garage doors and gates or lighting systems. The integrated universal remote control registers and stores signals from the original hand-held transmitters.

The signal of an original hand-held transmitter can be programmed on one of the three memory buttons **1**. After this, the programmed memory button **1** will operate the system in question. The LED **2** flashes to confirm transmission of the signal.

Should you sell your vehicle one day, be sure to delete the stored programs beforehand for your safety, refer to page **105**.

 To prevent possible damage or injury, before programming or using the integrated universal remote control, always inspect the immediate area to make certain that no people, animals or objects are within the pivoting or travel range of the device being operated. Comply also with the safety instructions supplied with the original hand-held transmitter. ◀

Checking compatibility

 If this symbol appears on the package or in the instructions supplied with the original hand-held transmitter, you can assume that the radio remote control device will be compatible with the integrated universal remote control.

For additional information, please contact your BMW center or call: 1-800-355-3515.

You can also obtain information on the Internet at:

www.bmwusa.com or
www.homelink.com.

HomeLink is a registered trademark of Johnson Controls, Inc. ◀

Programming



- 1** Memory buttons
- 2** LED

Fixed-code hand-held transmitters

1. Switch on the ignition, refer to page **50**.
2. When starting operation for the first time: press the left and right memory buttons **1** for approx. 20 seconds until the LED **2** flashes rapidly. The three memory buttons are cleared.
3. Hold the original hand-held transmitter at a distance of approx. 4 to 12 in/10 to 30 cm from the memory buttons **1**.

 The required distance between the hand-held transmitter and the memory buttons **1** depends on the system of the respective original hand-held transmitter used. ◀

4. Simultaneously press the transmit key on the original hand-held transmitter and the desired memory button **1** on the integrated universal remote control. The LED **2** flashes slowly at first. As soon as the LED **2** flashes rapidly, release both buttons. If the LED **2** does not flash rapidly after approx. 15 seconds, alter the distance and repeat this step.
5. To program other original hand-held transmitters, repeat steps 3 and 4.

The corresponding memory button **1** is now programmed with the signal of the original hand-held transmitter.

You can operate the device while the ignition is switched on.

 If the device fails to function even after repeated programming, check whether the original hand-held transmitter uses an alternating-code system. To do so, either read the instructions for the original hand-held transmitter or hold down the programmed memory button **1** of the integrated universal remote control. If the LED **2** on the integrated universal remote control flashes rapidly and then remains lit for about two seconds, the original hand-held transmitter uses an alternating-code system. If it uses an alternating-code system, program the memory buttons **1** as described under Alternating-code hand-held transmitters. ◀

Alternating-code hand-held transmitters

To program the integrated universal remote control, consult the operating instructions for the device to be set. You will find information there on the possibilities for synchronization. When programming hand-held transmitters that employ an alternating code, please observe the following supplementary instructions:

 Programming will be easier with the aid of a second person. ◀

1. Park your vehicle within the range of the remote-controlled device.
2. Program the integrated universal remote control as described above in the section Fixed-code hand-held transmitters.
3. Locate the button on the receiver of the device to be set, e.g. on the drive unit.
4. Press the button on the receiver of the device to be set. After step 4, you have approx. 30 seconds for step 5.
5. Press the programmed memory button **1** of the integrated universal remote control three times.

The corresponding memory button **1** is now programmed with the signal of the original hand-held transmitter.

 If you have any questions, please contact your BMW center. ◀

Deleting all stored programs

Press the left and right memory buttons **1** for approx. 20 seconds until the LED **2** flashes rapidly: all stored programs are deleted.

Reassigning individual programs

1. Hold the original hand-held transmitter at a distance of approx. 4 to 12 in/10 to 30 cm from the memory buttons **1**.

 The required distance between the hand-held transmitter and the memory buttons **1** depends on the system of the respective original hand-held transmitter used. ◀

2. Press the desired memory button **1** of the integrated universal remote control.
3. If the LED **2** flashes slowly after approx. 20 seconds, press the transmit key of the original hand-held transmitter. Release both buttons as soon as the LED **2** flashes rapidly. If the LED **2** does not flash rapidly after approx. 15 seconds, alter the distance and repeat this step.

Digital compass*

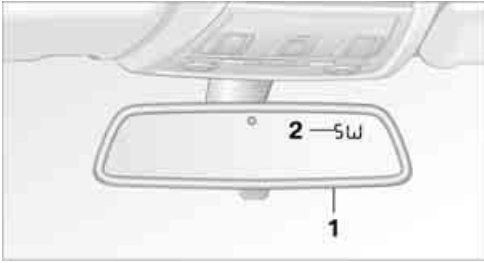

1 Adjustment button

2 Display

The display shows you the main or secondary compass direction in which you are driving.

Operating principle

You can call up various functions by pressing the adjustment button with a pointed object

such as a ballpoint pen or similar item. The following adjustment options are displayed one after the other, depending on how long you keep the adjustment button pressed:

- ▷ Press briefly: switch display on/off
- ▷ 3 to 6 seconds: set compass zone
- ▷ 6 to 9 seconds: calibrate compass
- ▷ 9 to 12 seconds: set left-hand/right-hand steering
- ▷ 12 to 15 seconds: set the language

Setting compass zones

Set the compass zone corresponding to your vehicle's geographic location so that the compass can function correctly; refer to the world map with compass zones.

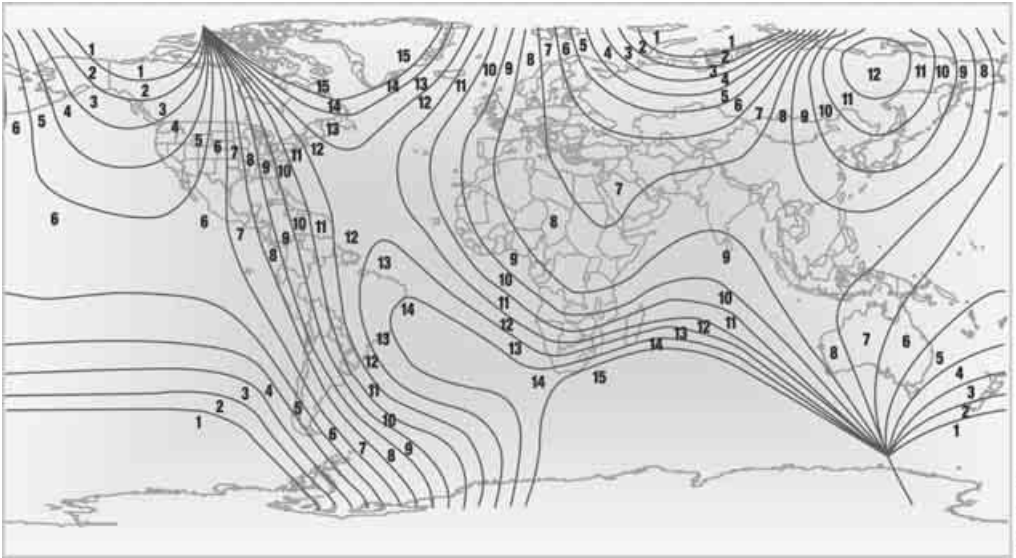

To set the compass zone, press the adjustment button for approx. 3-4 seconds. The number of the compass zone set is shown in the display.

To change the zone setting, briefly press the adjustment button repeatedly until the display shows the number of the compass zone corresponding to your current location.

The compass is operational again after approx. 10 seconds.

Calibrating the digital compass

The digital compass must be calibrated in the following situations:

- ▶ An incorrect compass direction is shown.
- ▶ The compass direction shown does not change although the direction of travel does.
- ▶ Not all compass directions are shown.

Procedure

1. Make sure that no large metal objects or overhead power lines are in the vicinity of your vehicle and that you have enough space to drive in a circle.
2. Set the currently valid compass zone.
3. Convertible: ensure that the retractable hardtop is fully closed.
4. Press the adjustment button for approx. 6-7 seconds to call up C. Then drive in at least one full circle at a speed of no more than 4 mph or 7 km/h.
If calibration is successful, the display changes from C to a compass direction.
5. Convertible: open the retractable hardtop fully and repeat step 4.

Setting right-hand/left-hand steering

Your digital compass is factory-set to right-hand or left-hand steering, in accordance with your vehicle.

Set the language

You can set the language of the display:

Press the adjustment button for approx. 12-13 seconds. Briefly press the adjustment button again to switch between English, "E", and German, "O".

The setting is automatically saved after approx. 10 seconds.

Coupe: Roller sun blind*



Tap the button in the center console to raise or lower the roller sun blind.

Glove compartment

Opening



Pull the handle.

The light in the glove compartment comes on.

 To prevent injury in the event of an accident while the vehicle is being driven, close the glove compartment immediately after use. ◀

Closing

Fold the cover up.

Locking

To lock the glove compartment, use the integrated key of the remote control, refer to page 18.

Convertible: when you lock the vehicle from the outside, the glove compartment is locked as well.

Center armrest

Storage compartment

The center armrest between the front seats contains either a compartment or the cover for the snap-in adapter*, depending on the equipment version.

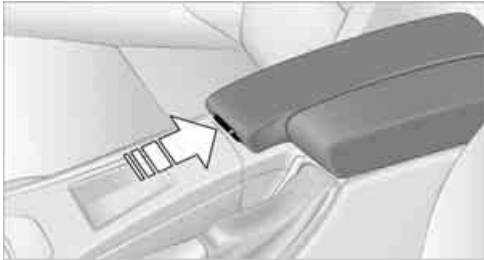

Opening

Press the button, see arrow.

Settings*



Slide the center armrest on the driver's side into the desired position.

Connection for external audio device

You can connect an external audio device such as a CD or MP3 player and play audio tracks over the car's loudspeaker system. You can set the volume and tone by means of the car radio, refer to the separate Owner's Manual for Radio.

Connecting

Lift up the center armrest.



AUX-IN port for audio playback:
TRS connector 1/8 in/3.5 mm

To play audio tracks over the car's loudspeaker system, connect the headset or line-out port of the external device to the connector.

Storage compartments inside the vehicle

Depending on your vehicle's equipment, you will find compartments beside the steering column*, in the front doors and in the center console*.

There are nets* on the front-seat backrests.

Storage compartments in the rear console

Depending on your vehicle's equipment version, the following storage compartments can be found in the rear console:



- ▷ Storage tray
- ▷ Storage compartment with cover
- ▷ Cupholders

Coupe: clothes hooks

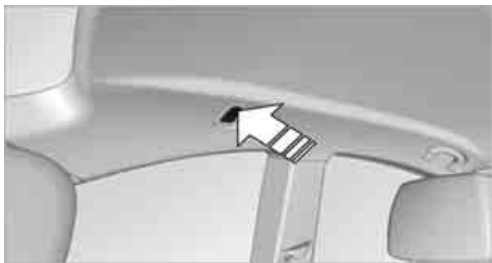

Press the upper edge to flip open.

! Items of clothing hung from the hooks must not obstruct the driver's view. Do not hang heavy objects from the hooks; otherwise, they could endanger the car's occupants, e.g. in case of heavy braking or sudden swerving. ◀

Cupholders

! Use lightweight and shatterproof containers and do not transport hot beverages; otherwise, there is an increased risk of injury in the event of the accident. Do not force containers that are too large into the cupholders; otherwise, damage could result. ◀

Front

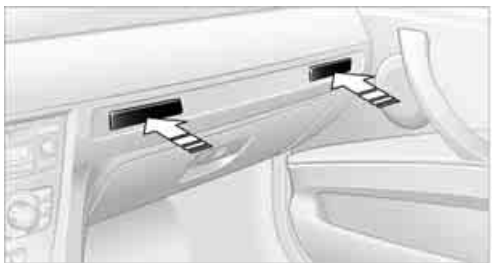

Opening

Briefly press the center of the cover.

Closing

Briefly press the cover in the center and push in the cupholder.

Coupe: rear

There are two additional cupholders in the rear center armrest.



Press the front of the armrest.

Convertible: rear

There are two additional cupholders in the rear console.

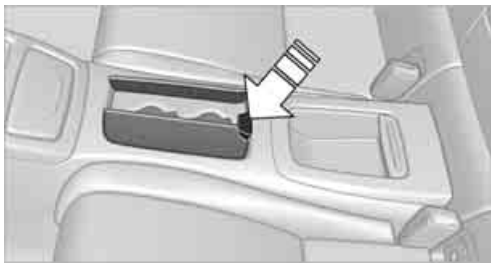

Press the button to open.

! Before folding down the rear seat backrest or using the transport bag, remove all containers from the cupholder and close it. Do not place objects into the cupholder and use force to close it. Do not use the cupholder as a grab handle. ◀

Ashtray*

Opening



Push the ridge on the cover.

Emptying



Lift out the insert.

Lighter



With the engine running or the ignition switched on, press in the cigarette lighter.

The lighter can be pulled out as soon as it pops back out.

 Hold or touch the hot cigarette lighter by the knob only. Holding or touching it in other areas could result in burns. When leaving the car, always remove the remote control so that children cannot operate the cigarette lighter and burn themselves. ◀

Connecting electrical appliances

In your BMW, when the engine is running or the ignition is switched on, you can use electrical devices such as a hand lamp, car vacuum cleaner, etc., up to approx. 200 watts at 12 volts, as long as one of the following sockets is available. Avoid damaging the sockets by attempting to insert plugs of unsuitable shape or size.

Cigarette lighter socket*

To access the socket: take the cigarette lighter out of the socket.

Socket* in the front passenger footwell

A socket is located under the glove compartment on the left.

Socket in the center armrest

External audio device, refer to page 108.

Coupe: socket in the cargo area*



Open the cap.

Coupe: Through-loading system*

Opening

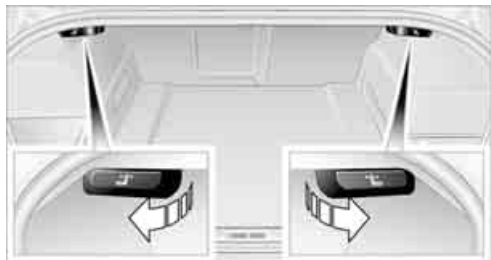

1. To release the rear seat backrest, pull the corresponding lever in the cargo area.
2. The unlocked rear seat backrest moves forward slightly. Fold the backrest forward by the head restraint.



Closing

Return the rear seat backrest to its upright position and engage it.

⚠ When returning the backrest to its seating position, make sure that the seat's locking mechanism engages properly. Otherwise, cargo could be thrown around in the event of sharp braking or swerving and endanger the occupants. ◀

The lashing eyes in the cargo area provide you with a way to attach cargo area nets* or draw straps for securing suitcases and luggage, refer to page 124.

Convertible: Cargo loading

Enlarging the cargo area

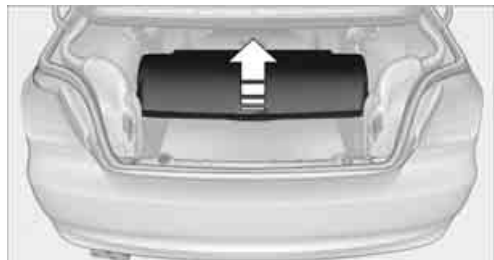

When the hardtop is closed you can enlarge the cargo area:

To do so, push the cargo area partition upward.

Before opening the hardtop, push the cargo area partition down until it engages on both sides.

⚠ Before moving the hardtop, ensure that there are no objects on or next to the cargo area partition; otherwise, parts of the hardtop may be damaged. Do not exceed the maximum loading height; refer to the sticker in the cargo area showing a line indicating the maximum height. Do not use force to push down the cargo area partition. ◀

▶ The retractable hardtop can only be opened if the cargo area partition is in its lowestmost position and engaged on both sides. ◀

Folding down the rear seat backrest

Opening

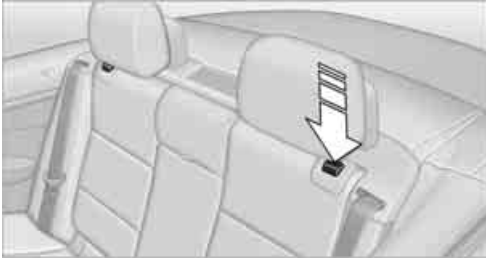

You can fold down the rear seat backrest to transport light objects in the rear without damaging the seats. Depending on the vehicle equipment, the mounting points for the cargo area net* are found on the back of the seat backrest. To unlock the rear seat backrest: press the button on the driver's or the opposite side.

Closing

Return the rear seat backrest to the upright seating position and engage it.

⚠ When returning the backrest to its seating position, make sure that the seat's locking mechanism engages properly. Otherwise, cargo could be thrown around in the event of sharp braking or swerving and endanger the occupants. ◀

Bag holder*

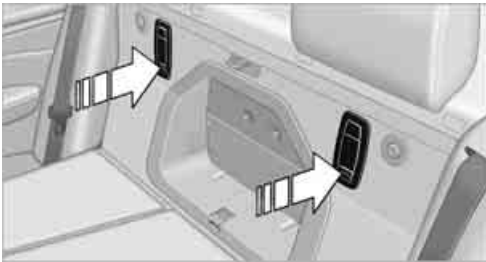

When the rear seat backrest is folded down, you will find two bag holders on the cargo area wall:

1. Fold open the holder by pressing the button.
2. Press the handles of the bag onto the holder from above.

⚠ Only hang light shopping bags or other suitable objects from the holders; otherwise, braking maneuvers and swerving, for example, may lead to a safety hazard due to objects flying about the passenger compartment. Only transport heavy luggage in the cargo area if it has been appropriately secured. ◀

For more information on loading the vehicle, refer to page 123.

Storage compartment behind the rear seat backrest

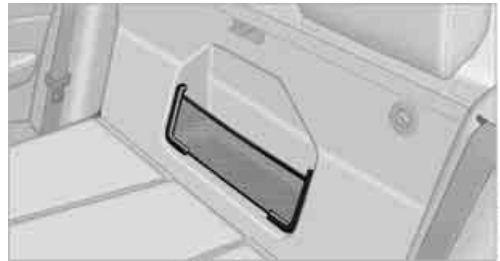

A storage compartment is located behind the rear seat backrest. To access the storage compartment: remove the insert or fold down the rear seat backrest.

⚠ When the rear seat backrest is folded down or the insert has been removed, only transport small light objects in the storage compartment; otherwise, braking maneuvers and swerving, for example, may lead to a safety hazard due to objects flying about the passenger compartment. Only transport heavy luggage in the cargo area if it has been appropriately secured. ◀

Storage compartments inside the cargo area

Coupe

Depending on your vehicle's equipment, the following storage spaces can be found in the cargo area:

- ▶ Left storage compartment, e.g. for storing a box of cleaning tissues or up to 12 CD jackets, depending on vehicle equipment version
- ▶ Net* for securing smaller objects, to be attached to the fixtures on the floor panel
- ▶ Hooks for hanging up, e.g., shopping bags or tote bags
- ▶ Rubber strap on the left trim panel for securing small objects such as a folding umbrella
- ▶ Net for small objects on the right trim panel of the cargo area

Convertible

Depending on your vehicle's equipment, the following storage spaces can be found in the cargo area:

- ▶ Storage compartment on the left side of the cargo area. To open turn handle by 90°
- ▶ Net* for securing smaller objects, to be attached to the fixtures on the floor panel
- ▶ Rubber strap* for subdividing the cargo area; can be hooked onto the lateral lashing eyes
- ▶ Stowage compartment under the floor panel

Folding up the floor panel

 Do not exceed the maximum permissible load of 55 lbs/25 kg for the storage compartment under the floor panel; otherwise, damage could result. ◀

Coupe

Press the floor panel up and secure it with the catch.

Convertible

To lift, grab hold of the floor panel at the opening at the rear of the panel.

Lashing eyes

You will find lashing eyelets in the cargo area for securing luggage items with nets or tensioning straps, refer to page 124.

Coupe: ski bag*

The ski bag is designed for safe, clean transport of up to 4 pairs of standard skis or up to 2 snowboards.

With the ski bag you can stow skis with a length of up to 6.9 ft 10 in/2.10 m. When skis of 6.9 ft 10 in/2.10 m length are loaded, the overall capacity of the ski bag is reduced due to its tapered design.

Loading

1. Fold down the center armrest.
2. Press the button, reach into the recess and fold down the cover.



3. Open the Velcro fastener, spread the ski bag between the front seats and insert the skis or snowboards. The zip fastener makes objects in the ski bag easier to reach.

- Clip the hooks of the ski bag retaining strap into the eyelet.



Only place clean skis in the ski bag. Wrap sharp edges to prevent damage.

Securing cargo

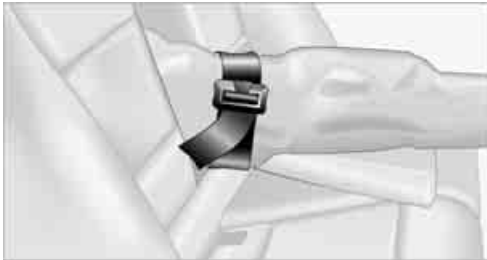

After loading, secure the ski bag and its contents. Tighten the retaining strap on the tensioning buckle for this purpose.

⚠ Secure the ski bag in the manner described; otherwise, it could endanger the car's occupants, e.g. in case of heavy braking or sudden swerving. ◀

To store the ski bag, perform the steps described for loading in reverse order.

Removing the ski bag

The ski bag can be completely removed, e.g. for faster drying or to allow you to use other inserts.

- Fold down the center panel in the rear seat backrest.
- Pull the handle, arrow 1.

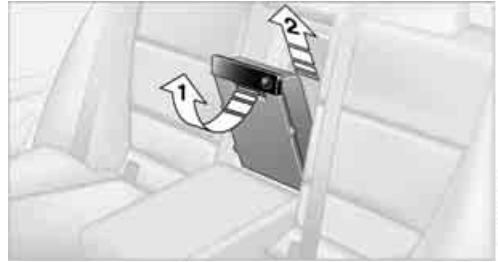

- Pull out the insert, arrow 2.

▶ For more information on the various inserts available, contact your BMW center. ◀

Convertible: through-loading opening with integrated transport bag*

The transport bag is designed for safe, clean transport of up to 4 pairs of standard skis or up to 2 snowboards.

When the rear seat backrest is folded up, you can remove the insert and use the transport bag with the regular through-loading opening. To transport larger objects, you can fold down the rear seat backrest to create an expanded through-loading opening.

With the transport bag you can stow skis with a length of up to 6.2 ft/1.90 m. When skis of 6.2 ft/1.90 m length are loaded, the overall capacity of the transport bag is reduced due to its tapered design.

Loading

1. For loading using the regular through-loading opening:
Press the button down and remove the insert from the front.
For loading with the through-loading opening expanded:
Fold down the rear seat backrest, refer to page 112.

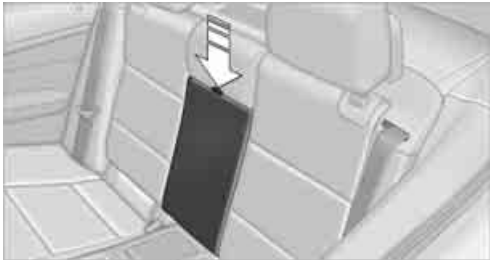

2. Front cover: press the two recesses together and fold the cover down until it engages.



3. In the cargo area: press the two recesses together and fold down the cover.

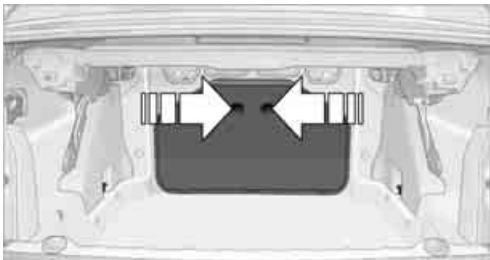

4. Undo the Velcro fastener and spread out the transport bag between the front seats.

5. Insert the latch plate of the retaining strap into the belt buckle under the transport bag.



6. Load the transport bag. The zipper eases access to the stored items.

Only place clean skis in the transport bag. Wrap sharp edges to prevent damage.

You can use the snaps to shorten the transport bag if you do not need its full length.

Securing cargo



After loading, secure the transport bag and its contents. Tighten the retaining strap on the tensioning buckle for this purpose.

 Secure the transport bag in the manner described; otherwise, it could endanger the car's occupants, e.g. in case of heavy braking or sudden swerving. ◀

To store the transport bag, perform the steps described for loading in reverse order.

Removing the front cover

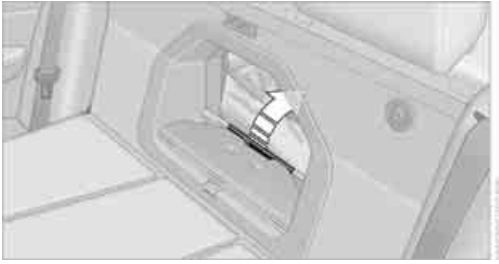

You can remove the front cover to use the full height of the through-loading opening. With the cover folded down, pull the handle, see arrow, and remove the cover toward the front. To replace, insert the cover at an angle from above and let it snap it into place.



Driving tips

This section provides you with information useful in dealing with specific driving and operating conditions.

Things to remember when driving

Break-in period

Moving parts need breaking-in time to adjust to each other. Please follow the instructions below in order to achieve the optimal service life and economy of operation for your vehicle.

Engine and differential

Always obey all official speed limits.

Up to 1,200 miles/2,000 km

Drive at varying engine and road speeds, but do not exceed an engine speed of 4,500 rpm or a road speed of 100 mph/160 km/h.

Avoid full-throttle operation and use of the transmission's kickdown mode.

After driving 1,200 miles/2,000 km

Engine and vehicle speeds can be gradually increased.

Tires

Due to technical factors associated with their manufacture, tires do not achieve their full traction potential until after an initial break-in period. Therefore, drive cautiously during the first 200 miles/300 km.

Brake system

Brakes require an initial break-in period of approx. 300 miles/500 km to achieve optimized contact and wear patterns between brake pads and rotors. Drive cautiously during this break-in period.

Clutch

The function of the clutch reaches its optimal level only after a distance driven of approx. 500 km. During this break-in period, engage the clutch gently.

Following part replacement

The same break-in procedures should be observed if any of the components mentioned above have to be renewed in the course of the vehicle's operating life.

Saving fuel

The fuel consumption of your vehicle depends on several factors. You can lower fuel consumption and the environmental impact by taking certain measures, adjusting your driving style and having the vehicle serviced regularly.

Remove any unneeded cargo

Additional weight increases fuel consumption.

Remove any mounted parts after you have finished using them

Remove unneeded additional mirrors, the roof rack and the rear luggage rack after use. Mounted parts affect the vehicle's aerodynamics and increase fuel consumption.

Close the windows and glass roof

An open glass roof or window causes higher air resistance and thus increases fuel consumption.

Check tire inflation pressure regularly

Check the tire inflation pressure at least twice a month and before embarking on a long journey, and correct it if necessary.

Low tire inflation pressure causes higher rolling resistance and thus increases fuel consumption and tire wear.

Set off immediately

Do not let the engine warm up while the car is still standing, but set off immediately at moderate engine speed. This is the fastest way for the cold engine to reach its operating temperature.

Drive defensively

Avoid unnecessary acceleration and braking maneuvers. To do so, keep an adequate distance between you and the vehicle in front of you. A defensive and smooth driving style keeps fuel consumption down.

Avoid high engine speeds

Only use first gear when setting off. In second and higher gears, accelerate without hesitation or pauses. When accelerating, shift up before reaching high engine speeds.

When you reach the desired speed, shift into the highest applicable gear and drive with the engine speed as low as possible and at a constant speed.

As a rule: driving at low engine speeds lowers fuel consumption and reduces wear.

Coasting

When approaching a red light, take your foot off the accelerator and coast to a stop in the highest applicable gear.

On a downhill slope, take your foot off the accelerator and coast in a suitable gear.

The fuel supply is interrupted when coasting.

Switch off the engine during lengthy stops

Switch off the engine when stopping for lengthy periods, e.g. at traffic lights, railroad crossings or in traffic congestions. You achieve fuel savings even if standing time is as short as approx. 4 seconds.

Switch off functions you do not need at the moment

Functions such as the air conditioner, seat heating or rear window defroster draw large amounts of power and consume additional fuel. Especially in city traffic and in stop and go driving they have a considerable impact. Therefore, switch these functions off when they are not really needed.

Have the vehicle serviced

Have the vehicle serviced regularly to achieve good economy and a long vehicle life. BMW recommends having the vehicle serviced at a BMW center. Also note the BMW service system, refer to page 148.

General driving notes

Close the trunk lid

 Operate the vehicle only when the trunk lid is closed. Otherwise, exhaust fumes could enter the interior of the vehicle. ◀

If the vehicle must be driven with the trunk lid open:

1. Close all windows and the glass roof.
2. Greatly increase the air volume of the air conditioner or automatic climate control system, refer to page 98 or 101.

Hot exhaust system

 In all vehicles, extremely high temperatures are generated in the exhaust system. Do not remove the heat shields installed adjacent to various sections of the exhaust system, and never apply undercoating to them. When driving, standing at idle and while parking, take care to avoid possible contact between the hot exhaust system and any highly flammable materials such as hay, leaves, grass, etc. Such contact could lead to a fire, with the risk of serious personal injuries and property damage. Do not touch hot exhaust tail pipes. Otherwise, there is a risk of burns. ◀

Hydroplaning

 When driving on wet or slushy roads, reduce road speed. If you do not, a wedge of water can form between tires and road surface. This situation, known as hydroplaning, means that the tire can completely lose contact with the road surface, so that neither the car can be steered nor the brake be properly applied. ◀ The risk of hydroplaning increases with declining tread depth on the tires, refer also to Minimum tread depth on page 141.

Driving through water

 Drive through water on the road only if it is not deeper than 1 ft/30 cm, and then only at walking speed at the most. Otherwise, the vehicle's engine, the electrical systems and the transmission may be damaged. ◀

Use the parking brake on inclines

 On inclines, do not hold the vehicle for a lengthy period using the clutch; use the parking brake instead. Otherwise, greater clutch wear will result. ◀

For more information about the drive-off assistant, refer to page 82.

Braking safely

Your BMW is equipped with ABS as a standard feature. Applying the brakes fully is the most effective way of braking in situations in which this is necessary. Since the vehicle maintains steering responsiveness, you can still avoid possible obstacles with a minimum of steering effort.

Pulsation of the brake pedal, combined with sounds from the hydraulic circuits, indicate that ABS is in its active mode.

Driving in wet conditions

When roads are wet or there is heavy rain, briefly exert gentle pressure on the brake pedal every few miles. Monitor traffic conditions to ensure that this maneuver does not endanger other road users. The heat generated in this process helps dry the pads and rotors to ensure that full braking efficiency will then be available when you need it.

Hills

 To prevent overheating and the resulting reduced efficiency of the brake system, drive long or steep downhill gradients in the gear in which the least braking is required. Even light but consistent brake pressure can lead to high temperatures, brake wear and possibly even brake failure. ◀

You can increase the engine's braking effect by shifting down, all the way to first gear if necessary. This strategy helps you avoid placing excessive loads on the brake system. Downshifting in manual mode of the automatic transmission, refer to page 54.

 Sports automatic transmission with double clutch: never drive with the transmission in neutral or with the engine switched off; otherwise, there will be no engine braking action and no power assistance to the brakes and steering.

Manual transmission: never drive with the clutch held down, with the transmission in neutral or with the engine switched off; otherwise, engine braking action will not be present or there will be no power assistance to the brakes or steering.

Never allow floor mats, carpets or any other objects to protrude into the area around the pedals; otherwise, pedal function could be impaired. ◀

Corrosion on brake rotors

When the vehicle is driven only occasionally, during extended periods when the vehicle is not used at all, and in operating conditions where brake applications are less frequent, there is an increased tendency for corrosion to form on rotors, while contaminants accumulate on the brake pads. This occurs because the minimum pressure which must be exerted by the pads during brake applications to clean the rotors is not reached.

Should corrosion form on the brake rotors, the brakes will tend to respond with a pulsating effect that even extended application will fail to cure.

When the vehicle is parked

Condensation forms while the automatic climate control is in operation, and then exits under the vehicle. Traces of condensed water under the vehicle are therefore normal.

Cargo loading

 To avoid loading the tires beyond their approved carrying capacity, never overload the vehicle. Overloading can lead to overheating and increases the rate at which damage develops inside the tires. In some situations, this can result in sudden loss of tire pressure. ◀

 Make sure that no liquids are spilled or leak from their containers in the cargo area, as this could result in damage to the vehicle. ◀

Determining loading limit



1. Locate the following statement on your vehicle's placard*:
 The combined weight of occupants and cargo should never exceed XXX kg or YYY lbs. Otherwise, overloading can result in damage to the vehicle and unstable driving conditions. ◀
2. Determine the combined weight of the driver and passengers that will be riding in your vehicle.
3. Subtract the combined weight of the driver and passengers from XXX kilograms or YYY pounds.
4. The resulting figure equals the available amount of cargo and luggage load capacity. For example, if the YYY amount equals 1,400 lbs. and there will be five 150-lb. passengers in your vehicle, the amount of available cargo and luggage load capacity is 650 lbs:
$$1,400 \text{ lbs.} - 750 \text{ lbs.} = 650 \text{ lbs.}$$
5. Determine the combined weight of luggage and cargo being loaded on the vehicle. That weight may not safely exceed the available cargo and luggage load capacity calculated in step 4.
6. If your vehicle will be towing a trailer, part of the load from your trailer will be transferred to your vehicle. Consult the manual for transporting a trailer to determine how this may reduce the available cargo and luggage load capacity of your vehicle.

Load

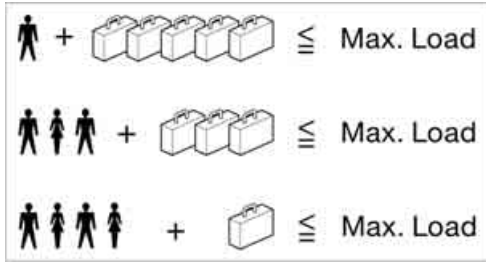

The permissible load is the total of the weight of occupants and cargo/luggage. The greater the weight of the occupants, the less cargo/luggage can be transported.

Stowing cargo

- ▷ Position heavy objects as low and as far forward as possible, ideally directly behind the respective seat backrests.
- ▷ Cover sharp edges and corners.
- ▷ For very heavy cargo when the rear seat is not occupied, secure each safety belt in the opposite buckle.

Coupe

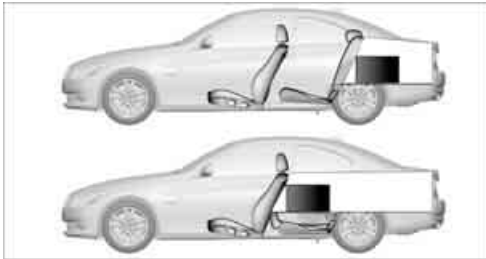

Convertible

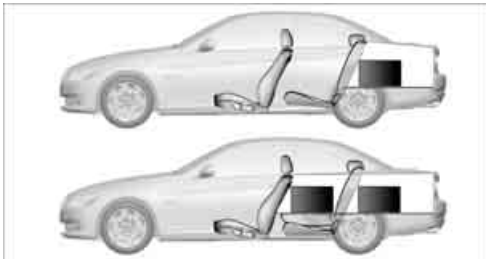

Securing cargo

Coupe

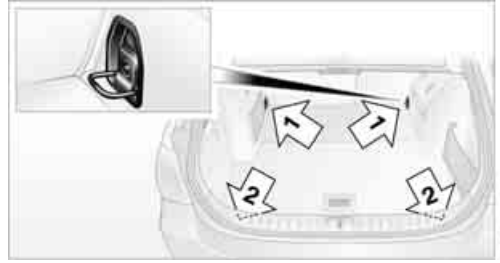

Convertible

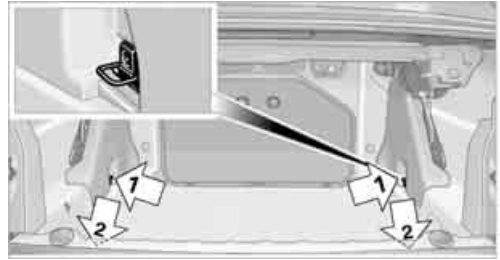

- ▷ Secure smaller and lighter items using retaining straps, a cargo area net* or draw straps*.
- ▷ Heavy-duty cargo straps* for securing larger and heavier objects are available at your BMW center. Four lashing eyes are provided for attaching the cargo straps. Two are located on the cargo area sidewalls **1**, two more are on the rear cargo area panel **2**. Please comply with the information supplied with the cargo straps.

⚠ Convertible: before opening the hardtop, fold down the cargo area partition. Make sure the cargo area is loaded correctly; otherwise parts of the hardtop can be damaged, refer to page 111. ◀

⚠ Always position and secure the cargo as described above, so that it cannot endanger the car's occupants, for example if sudden braking or swerving is necessary. Never exceed either the approved gross vehicle weight or either of the approved axle loads, refer to page 181; otherwise, excessive loads can

pose a safety hazard, and may also place you in violation of traffic safety laws.

Heavy or hard objects should not be carried loose inside the car, since they could be thrown around, for example as a result of heavy braking, sudden swerves, etc., and endanger the occupants.

Only attach the cargo straps using the lashing eyes shown in the illustration. Do not secure cargo with the anchors for tether straps, refer to page 48; otherwise, these could be damaged. ◀

Coupe: roof-mounted luggage rack*

A special rack system is available as an option for your BMW. Comply with the directions given in the installation instructions.

Mounting points

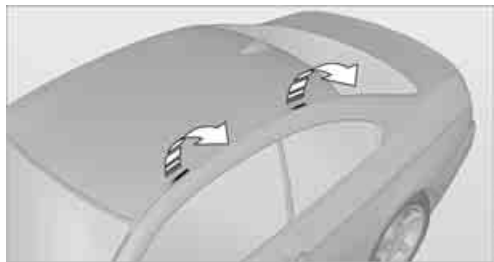

The mounting points are located in the roof.

Loading roof-mounted luggage rack

Because roof racks raise the vehicle's center of gravity when loaded, they have a major effect on vehicle handling and steering response.

You should therefore always remember not to exceed the approved roof load capacity, the approved gross vehicle weight or the axle loads when loading the rack.

You can find the applicable data under Weights on page 181.

The roof load must be distributed uniformly and should not be too large in area. Heavy items should always be placed at the bottom. Be sure that adequate clearance is maintained for raising the glass roof, and that objects do not project into the opening path of the trunk lid.

Fasten roof-mounted cargo correctly and securely to prevent it from shifting or falling off during the trip.

Drive smoothly. Avoid sudden acceleration and braking maneuvers. Take corners gently.

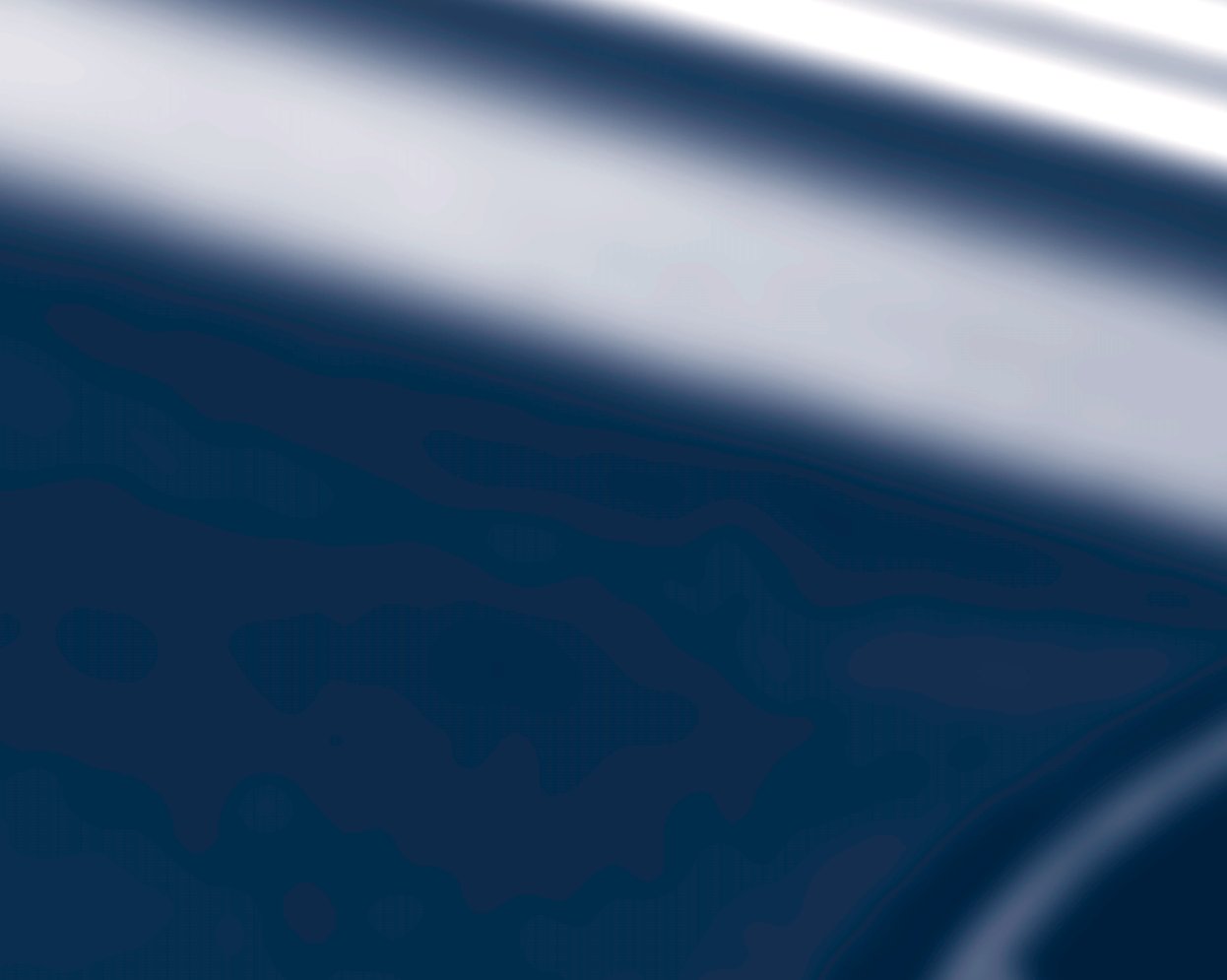



Mobility

This section helps you maintain your car's mobility by supplying important information on vital topics including fuels and lubricants, wheels and tires, service, maintenance and roadside assistance.

Refueling

⚠ Always switch off the engine before refueling; otherwise, fuel cannot be added to the tank and a message will be displayed. ◀

⚠ Take all precautionary measures and observe all applicable regulations when handling fuel. Do not carry any spare fuel containers in your vehicle. They can develop a leak and cause an explosion or cause a fire in the event of an accident. ◀

Fuel filler flap

Opening

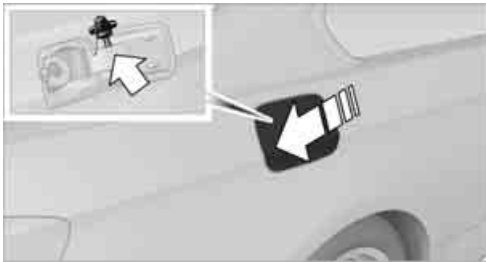

1. Open the fuel filler flap. To do so, lightly press the rear edge.
2. Turn the gas cap counterclockwise.
3. Place the gas cap in the bracket attached to the fuel filler flap.

Closing

Fit the cap and turn it clockwise until you clearly hear a click.

⚠ Do not pinch the band attached to the cap; otherwise, the cap cannot be closed properly and fuel vapors can escape. ◀

Manually releasing the fuel filler flap

In the event of a malfunction, you can release the fuel filler flap manually:

Coupe



1. Remove the cover from the right-hand side-wall of the cargo area.
2. Pull the knob with the fuel pump symbol. The fuel filler flap is released.

Convertible

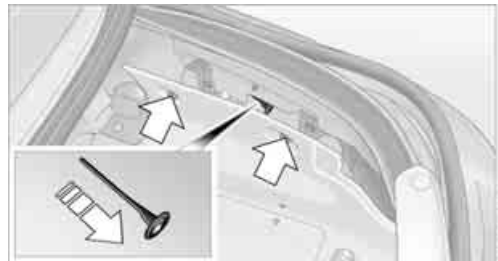

1. Loosen the right-hand cargo area trim panel by turning the screws by 90°, see arrow.
2. Slightly lift the top section of the panel. It is not necessary to remove the entire panel.
3. Pull the knob with the fuel pump symbol. The fuel filler flap is released.

Observe the following when refueling

 When handling fuels, follow the safety instructions provided at filling stations; otherwise, there is a risk of personal injury or property damage. ◀

When refueling, insert the filler nozzle completely into the filler pipe. Avoid lifting the filler nozzle while filling the tank, as that would lead to

- ▷ Premature pump shutoff
- ▷ Reduced efficiency of the fuel-vapor recovery system.

The fuel tank is full when the filler nozzle clicks off the first time.

Fuel tank capacity

Approx. 16.1 US gallons/61 liters, including the reserve capacity of 2.1 US gallons/8 liters.

 Refuel as soon as possible once your cruising range falls below 30 miles/50 km; otherwise, engine functions are not ensured and damage can occur. ◀

Fuel specifications

Gasoline engine: required fuel

 Do not refuel with leaded fuel; otherwise, the catalytic converter will be damaged. Do not fill the tank with E85, i.e. fuel containing 85 % ethanol, nor with FlexFuel. Otherwise, the engine and fuel supply system will be damaged. ◀

Super Premium Gasoline/AKI 91

This gasoline is highly recommended.

However, you may also use gasoline with less AKI. The minimum AKI Rating is:

- ▷ 328i/xDrive: 87
- ▷ 335i, 335i/xDrive: 89.

If you use gasoline with this minimum AKI Rating, the engine may produce knocking sounds when starting at high outside temperatures.

This has no effect on the engine life.

 Do not use any gasoline below the specified minimum fuel grade. Otherwise, the engine could be damaged. ◀

Use high-quality brands

Field experience has indicated significant differences in fuel quality: volatility, composition, additives, etc., among gasolines offered for sale in the United States and Canada. Fuels containing up to and including 10 % ethanol or other oxygenates with up to 2.8 % oxygen by weight, that is, 15 % MTBE or 3 % methanol plus an equivalent amount of cosolvent, will not void the applicable warranties with respect to defects in materials or workmanship.

 The use of poor-quality fuels may result in drivability, starting and stalling problems especially under certain environmental conditions such as high ambient temperature and high altitude.

Should you encounter drivability problems which you suspect could be related to the fuel you are using, we recommend that you respond by switching to a recognized high-quality brand such as gasoline that is advertised as Top Tier Detergent Gasoline.

Failure to comply with these recommendations may also result in unscheduled maintenance. ◀

BMW recommends BP fuels 

Wheels and tires

Tire inflation pressures

Information for your safety

It is not merely the tires' service life, but also driving comfort and, to a great extent, driving safety that depend on the condition of the tires and the maintenance of the specified tire pressure.

 Check the tire inflation pressure regularly and correct it, if necessary: at least twice a month and before starting long trips. If you fail to observe this precaution you may be driving on tires with incorrect tire pressures, a condition that can not only compromise your vehicle's driving stability, but also lead to tire damage and the risk of an accident. Do not drive with deflated, i.e. flat tires, except when using run-flat tires. A flat tire will seriously impair your vehicle's handling and braking response. Attempts to drive on a flat tire can lead to loss of control over the vehicle. ◀

Checking pressure

Only check tire inflation pressure when the tires are cold. This means after a maximum of 1.25 miles/2 km driving or when the vehicle has been parked for at least 2 hours. When tires are warm, the tire inflation pressure is higher.

 After correcting the tire inflation pressure, reset the Tire Pressure Monitor, refer to page 85, or reinitialize the Flat Tire Monitor, refer to page 83. ◀

Inflation pressure specifications

The tables below provide all the correct inflation pressures for the specified tire sizes at ambient temperature.

 The inflation pressures apply to the tire sizes approved and tire brands recommended by BMW; a list of these is available from your BMW center. ◀

For correct identification of the right tire inflation pressures, observe the following:

- ▷ Tire sizes for your vehicle
- ▷ Load conditions
- ▷ Maximum allowable driving speed

Tire inflation pressures for driving up to 100 mph or 160 km/h

For normal driving up to 100 mph or 160 km/h and to achieve optimum driving comfort, adjust pressures to the respective tire inflation pressures listed on the following pages in the columns for traveling speeds up to a maximum of 100 mph or 160 km/h.

These tire inflation pressures can also be found on the driver's side door post when the driver's door is open.





 The maximum permissible speed for these tire pressures is 100 mph or 160 km/h. Do not exceed this speed; otherwise, tire damage and accidents could occur. ◀

Tire inflation pressures for driving above 100 mph or 160 km/h

 In order to drive at maximum speeds in excess of 100 mph or 160 km/h, adjust pressures to the respective tire inflation pressures listed on the following pages in the columns for traveling speeds including those exceeding 100 mph or 160 km/h. Otherwise, tire damage and accidents could occur. ◀

Observe all national and local maximum speed limits; otherwise, violations of the laws could occur.

Coupe: tire inflation pressures for the 328i

Tire size	Pressure specifications in psi/kPa			
	Traveling speeds up to a max. of 100 mph / 160 km/h		Traveling speeds including those exceeding 100 mph / 160 km/h	
All pressure specifications in the table are indicated in psi/kilopascal with cold tires. Cold = ambient temperature				

Without Sport Package:

205/55 R 16 91 H M+S				
225/50 R 16 92 H M+S	32/220	38/260	36/250	44/300
225/45 R 17 91 H M+S				
225/45 R 17 91 V				
225/45 R 17 94 V M+S XL	32/220	39/270	36/250	44/300
Front: 225/45 R 17 91 V	32/220	-	36/250	-
Rear: 255/40 R 17 94 V	-	35/240	-	39/270
Front: 225/40 R 18 88 W	32/220	-	36/250	-
Rear: 255/35 R 18 90 W	-	39/270	-	42/290
Front: 225/35 R 19 88 Y XL	36/250	-	36/250	-
Rear: 255/30 R 19 91 Y XL	-	44/300	-	44/300

With Sport Package:

205/55 R 16 91 H M+S				
225/50 R 16 92 H M+S	32/220	38/260	36/250	44/300
225/45 R 17 91 H M+S				
225/45 R 17 91 V	32/220	38/260	42/290	49/340
225/45 R 17 94 V M+S XL	32/220	39/270	42/290	49/340
Front: 225/45 R 17 91 V	32/220	-	42/290	-
Rear: 255/40 R 17 94 V	-	35/240	-	44/300
Front: 225/40 R 18 88 W	32/220	-	39/270	-
Rear: 255/35 R 18 90 W	-	39/270	-	46/320
Front: 225/35 R 19 88 Y XL	36/250	-	39/270	-
Rear: 255/30 R 19 91 Y XL	-	44/300	-	46/320

More details on the permissible load and weights can be found on page [181](#).

Coupe: tire inflation pressures for the 328xi

Tire size	Pressure specifications in psi/kPa			
	Traveling speeds up to a max. of 100 mph / 160 km/h		Traveling speeds including those exceeding 100 mph / 160 km/h	

All pressure specifications in the table are indicated in psi/kilopascal with cold tires. Cold = ambient temperature



Without Sport Package:



205/55 R 16 91 H M+S				
225/50 R 16 92 H M+S	32/220	38/260	35/240	42/290
225/45 R 17 91 H M+S				
225/45 R 17 91 V				
225/45 R 17 94 V M+S XL	32/220	39/270	36/250	44/300
Front: 225/45 R 17 91 V	32/220	-	33/230	-
Rear: 255/40 R 17 94 V	-	33/230	-	39/270
Front: 225/40 R 18 88 W	33/230	-	36/250	-
Rear: 255/35 R 18 90 W	-	38/260	-	42/290
Front: 225/35 R 19 88 Y XL	39/270	-	39/270	-
Rear: 255/30 R 19 91 Y XL	-	44/300	-	44/300

With Sport Package:

205/55 R 16 91 H M+S				
225/50 R 16 92 H M+S	32/220	38/260	35/240	42/290
225/45 R 17 91 H M+S				
225/45 R 17 91 V	32/220	38/260	41/280	48/330
225/45 R 17 94 V M+S XL	32/220	39/270	41/280	48/330
Front: 225/45 R 17 91 V	32/220	-	41/280	-
Rear: 255/40 R 17 94 V	-	33/230	-	42/290
Front: 225/40 R 18 88 W	33/230	-	39/270	-
Rear: 255/35 R 18 90 W	-	38/260	-	46/320
Front: 225/35 R 19 88 Y XL	39/270	-	41/280	-
Rear: 255/30 R 19 91 Y XL	-	44/300	-	46/320

More details on the permissible load and weights can be found on page [181](#).

Coupe: tire inflation pressures for the 335i

Tire size	Pressure specifications in psi/kPa			
	Traveling speeds up to a max. of 100 mph / 160 km/h		Traveling speeds including those exceeding 100 mph / 160 km/h	
All pressure specifications in the table are indicated in psi/kilopascal with cold tires. Cold = ambient temperature				

Without Sport Package:

225/45 R 17 91 H M+S	32/220	39/270	38/260	45/310
225/45 R 17 94 V M+S XL	33/230	41/280	38/260	45/310
Front: 225/45 R 17 91 V	32/220	-	38/260	-
Rear: 255/40 R 17 94 V	-	35/240	-	41/280
Front: 225/40 R 18 88 W	32/220	-	38/260	-
Rear: 255/35 R 18 90 W	-	39/270	-	45/310
Front: 225/40 R 18 88 Y	32/220	-	35/240	-
Rear: 255/35 R 18 90 Y	-	39/270	-	41/280
Front: 225/35 R 19 88 Y XL	38/260	-	38/260	-
Rear: 255/30 R 19 91 Y XL	-	45/310	-	45/310

With Sport Package:

225/45 R 17 91 H M+S	32/220	39/270	38/260	45/310
225/45 R 17 94 V M+S XL	33/230	41/280	42/290	49/340
Front: 225/45 R 17 91 V	32/220	-	38/260	-
Rear: 255/40 R 17 94 V	-	35/240	-	44/300
Front: 225/40 R 18 88 W	32/220	-	41/280	-
Rear: 255/35 R 18 90 W	-	39/270	-	48/330
Front: 225/40 R 18 88 Y	32/220	-	36/250	-
Rear: 255/35 R 18 90 Y	-	39/270	-	44/300
Front: 225/35 R 19 88 Y XL	38/260	-	41/280	-
Rear: 255/30 R 19 91 Y XL	-	45/310	-	48/330

More details on the permissible load and weights can be found on page [181](#).

Coupe: tire inflation pressures for the 335xi

Tire size	Pressure specifications in psi/kPa			
	Traveling speeds up to a max. of 100 mph / 160 km/h		Traveling speeds including those exceeding 100 mph / 160 km/h	

All pressure specifications in the table are indicated in psi/kilopascal with cold tires. Cold = ambient temperature



Without Sport Package:



225/45 R 17 91 H M+S	32/220	39/270	39/270	45/310
225/45 R 17 94 V M+S XL	33/230	41/280	39/270	45/310
Front: 225/45 R 17 91 V	32/220	-	39/270	-
Rear: 255/40 R 17 94 V	-	35/240	-	39/270
Front: 225/40 R 18 88 W	35/240	-	38/260	-
Rear: 255/35 R 18 90 W	-	39/270	-	42/290
Front: 225/40 R 18 88 Y	35/240	-	35/240	-
Rear: 255/35 R 18 90 Y	-	39/270	-	39/270
Front: 225/35 R 19 88 Y XL	39/270	-	39/270	-
Rear: 255/30 R 19 91 Y XL	-	45/310	-	45/310

With Sport Package:

225/45 R 17 91 H M+S	32/220	39/270	39/270	45/310
225/45 R 17 94 V M+S XL	33/230	41/280	42/290	49/340
Front: 225/45 R 17 91 V	32/220	-	39/270	-
Rear: 255/40 R 17 94 V	-	35/240	-	44/300
Front: 225/40 R 18 88 W	35/240	-	42/290	-
Rear: 255/35 R 18 90 W	-	39/270	-	48/330
Front: 225/40 R 18 88 Y	35/240	-	39/270	-
Rear: 255/35 R 18 90 Y	-	39/270	-	42/290
Front: 225/35 R 19 88 Y XL	39/270	-	42/290	-
Rear: 255/30 R 19 91 Y XL	-	45/310	-	48/330



More details on the permissible load and weights can be found on page [181](#).

Coupe: inflation pressures 335is

Tire size	Pressure specifications in psi/kPa			
	Traveling speeds up to a max. of 100 mph / 160 km/h		Traveling speeds including those exceeding 100 mph / 160 km/h	
All pressure specifications in the table are indicated in psi/kilopascal with cold tires. Cold = ambient temperature				
225/45 R 17 91 H M+S	32/220	39/270	38/260	45/310
225/45 R 17 94 V M+S XL	35/240	42/290	44/300	49/340
Front: 225/40 R 18 88 W	33/230	-	42/290	-
Rear: 255/35 R 18 90 W	-	41/280	-	49/340
Front: 225/40 R 18 88 Y	33/230	-	38/260	-
Rear: 255/35 R 18 90 Y	-	41/280	-	45/310
Front: 225/35 R 19 88 Y XL	39/270	-	42/290	-
Rear: 255/30 R 19 91 Y XL	-	46/320	-	49/340

More details on the permissible load and weights can be found on page [181](#).

Convertible: tire inflation pressures for the 328i

Tire size	Pressure specifications in psi/kPa			
	Traveling speeds up to a max. of 100 mph / 160 km/h		Traveling speeds including those exceeding 100 mph / 160 km/h	
All pressure specifications in the table are indicated in psi/kilopascal with cold tires. Cold = ambient temperature				

Without Sport Package:

205/55 R 16 91 H M+S	33/230	41/280	36/250	44/300
225/50 R 16 92 H M+S				
225/45 R 17 91 H M+S	33/230	41/280	39/270	46/320
225/45 R 17 91 W	33/230	41/280	36/250	44/300
225/45 R 17 94 V M+S XL	35/240	42/290	39/270	46/320
Front: 225/45 R 17 91 V	32/220	-	36/250	-
Rear: 255/40 R 17 94 V	-	36/250	-	42/290
Front: 225/40 R 18 88 W	35/240	-	38/260	-
Rear: 255/35 R 18 90 W	-	42/290	-	45/310
Front: 225/40 R 18 88 Y	35/240	-	35/240	-
Rear: 255/35 R 18 90 Y	-	42/290	-	42/290
Front: 225/35 R 19 88 Y XL	39/270	-	39/270	-
Rear: 255/30 R 19 91 Y XL	-	46/320	-	46/320

With Sport Package:

205/55 R 16 91 H M+S	33/230	41/280	36/250	44/300
225/50 R 16 92 H M+S				
225/45 R 17 91 H M+S	33/230	41/280	41/280	48/330
225/45 R 17 91 W				
225/45 R 17 94 V M+S XL	35/240	42/290	42/290	49/340
Front: 225/45 R 17 91 V	32/220	-	41/280	-
Rear: 255/40 R 17 94 V	-	36/250	-	45/310
Front: 225/40 R 18 88 W	35/240	-	42/290	-
Rear: 255/35 R 18 90 W	-	42/290	-	49/340
Front: 225/40 R 18 88 Y	35/240	-	38/260	-
Rear: 255/35 R 18 90 Y	-	42/290	-	45/310

Tire size

Pressure specifications in psi/kPa

All pressure specifications in the table are indicated in psi/kilopascal with cold tires. Cold = ambient temperature

Traveling speeds up to a max. of 100 mph / 160 km/h



Traveling speeds including those exceeding 100 mph / 160 km/h



Front: 225/35 R 19 88 Y XL

39/270

-

42/290

-

Rear: 255/30 R 19 91 Y XL

-



46/320

-

49/340

More details on the permissible load and weights can be found on page [181](#).

Convertible: tire inflation pressures for the 335i

Tire size	Pressure specifications in psi/kPa			
	Traveling speeds up to a max. of 100 mph / 160 km/h		Traveling speeds including those exceeding 100 mph / 160 km/h	
All pressure specifications in the table are indicated in psi/kilopascal with cold tires. Cold = ambient temperature				

Without Sport Package:



225/45 R 17 91 H M+S	33/230	41/280	39/270	46/320
225/45 R 17 94 V M+S XL	35/240	42/290	39/270	46/320
Front: 225/45 R 17 91 V	32/220	-	36/250	-
Rear: 255/40 R 17 94 V	-	36/250	-	42/290
Front: 225/40 R 18 88 W	35/240	-	38/260	-
Rear: 255/35 R 18 90 W	-	42/290	-	45/310
Front: 225/40 R 18 88 Y	35/240	-	35/240	-
Rear: 255/35 R 18 90 Y	-	42/290	-	42/290
Front: 225/35 R 19 88 Y XL	39/270	-	39/270	-
Rear: 255/30 R 19 91 Y XL	-	46/320	-	46/320

With Sport Package:

225/45 R 17 91 H M+S	33/230	41/280	39/270	46/320
225/45 R 17 94 V M+S XL	35/240	42/290	42/290	49/340
Front: 225/45 R 17 91 V	32/220	-	41/280	-
Rear: 255/40 R 17 94 V	-	36/250	-	45/310
Front: 225/40 R 18 88 W	35/240	-	42/290	-
Rear: 255/35 R 18 90 W	-	42/290	-	49/340
Front: 225/40 R 18 88 Y	35/240	-	38/260	-
Rear: 255/35 R 18 90 Y	-	42/290	-	45/310
Front: 225/35 R 19 88 Y XL	39/270	-	42/290	-
Rear: 255/30 R 19 91 Y XL	-	46/320	-	49/340

More details on the permissible load and weights can be found on page [181](#).

Convertible: inflation pressures 335is

Tire size	Pressure specifications in psi/kPa			
	Traveling speeds up to a max. of 100 mph / 160 km/h		Traveling speeds including those exceeding 100 mph / 160 km/h	
<p>All pressure specifications in the table are indicated in psi/kilopascal with cold tires. Cold = ambient temperature</p>				
	<hr/>			
225/45 R 17 91 H M+S	33/230	41/280	39/270	46/320
225/45 R 17 94 V M+S XL	35/240	42/290	42/290	49/340
Front: 225/40 R 18 88 W	35/240	-	42/290	-
Rear: 255/35 R 18 90 W	-	42/290	-	49/340
Front: 225/40 R 18 88 Y	35/240	-	38/260	-
Rear: 255/35 R 18 90 Y	-	42/290	-	45/310
Front: 225/35 R 19 88 Y XL	39/270	-	42/290	-
Rear: 255/30 R 19 91 Y XL	-	46/320	-	49/340
<p>More details on the permissible load and weights can be found on page 181.</p>				

Tire identification marks

Knowledge of the labeling on the side of the tire makes it easier to identify and choose the right tires.

Tire size

e.g. 225/45 R 17 91 V

Nominal width in mm ————
 Aspect ratio in % ————
 Radial belt construction ————
 Rim diameter in inches ————
 Load rating, not on ZR tires ————
 Speed code letter, in front of the R on ZR tires ————

Speed code letter

Q = up to 100 mph or 160 km/h
 T = up to 118 mph or 190 km/h
 H = up to 131 mph or 210 km/h
 V = up to 150 mph or 240 km/h
 W = up to 167 mph or 270 km/h
 Y = up to 186 mph or 300 km/h

Tire Identification Number

Tires with DOT codes meet the guidelines of the US Department of Transportation.

DOT code:

e.g. DOT xxxx xxx 1010

Manufacturer's code for tire make ————
 Tire size and tire design ————
 Tire age ————

Tire age

The manufacturing date of tires is contained in the tire coding: DOT ... 1010 means that the tire was manufactured in week 10 of 2010.

BMW recommends that you replace all tires after 6 years at most, even if some tires may last for 10 years.

Uniform Tire Quality Grading

Quality grades can be found where applicable on the tire sidewall between tread shoulder and maximum section width. For example:

Tread wear 200 Traction AA
 Temperature A

DOT Quality Grades

Tread wear
 Traction AA A B C
 Temperature A B C



All passenger car tires must conform to Federal Safety Requirements in addition to these grades. ◀

Tread wear

The tread wear grade is a comparative rating based on the wear rate of the tire when tested under controlled conditions on a specified government test course. For example, a tire graded 150 would wear one and one-half (1 ½) times as well on the government course as a tire graded 100. The relative performance of tires depends upon the actual conditions of their use, however, and may depart significantly from the norm due to variations in driving habits, service practices and differences in road characteristics and climate.

Traction

The traction grades, from highest to lowest, are AA, A, B, and C.

Those grades represent the tire's ability to stop on wet pavement as measured under controlled conditions on specified government test surfaces of asphalt and concrete. A tire marked C may have poor traction performance.



The traction grade assigned to this tire is based on straight-ahead braking traction tests, and does not include acceleration, cornering, hydroplaning, or peak traction characteristics. ◀

Temperature

The temperature grades are A, the highest, B, and C, representing the tire's resistance to the generation of heat and its ability to dissipate heat when tested under controlled conditions on a specified indoor laboratory test wheel. Sustained high temperature can cause the material of the tire to degenerate and reduce tire life, and excessive temperature can lead to sudden tire failure. The grade C corresponds to a level of performance which all passenger car tires must meet under the Federal Motor Vehicle Safety Standard No. 109. Grades B and A represent higher levels of performance on the laboratory test wheel than the minimum required by law.

 The temperature grade for this tire is established for a tire that is properly inflated and not overloaded. Excessive speed, underinflation, or excessive loading, either separately or in combination, can cause heat buildup and possible tire failure. ◀

RSC – run-flat tires

You will recognize run-flat tires by a circular symbol containing the letters RSC on the side of the tire, refer to page 142.

M+S

Winter and all-season tires. These have better winter properties than summer tires.

XL

Designation for specially reinforced tires.

Tire condition

Inspect your tires frequently for tread wear, signs of damage and for foreign objects lodged in the tread. Check the tread depth.

Minimum tread depth

The tread depth should not drop below 0.12 in/ 3 mm, although, for example, European legislation only specifies a minimum tread depth of

0.063 in/1.6 mm. At tread depths below 0.12 in/3 mm there is an increased risk of high-speed hydroplaning, even when only small amounts of water are present on the road surface.

When winter tires wear down past a tread depth of 0.16 in/4 mm, they become perceptibly less suitable for winter conditions. In the interest of safety, new tires should be installed.

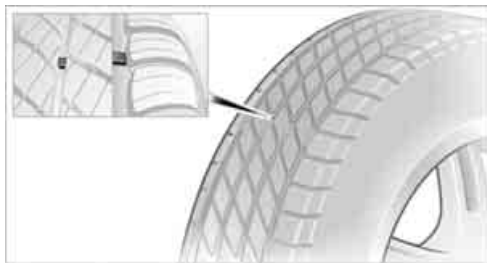

Wear indicators in the base of the tread groove are distributed around the tire's circumference; the letters TWI, for Tread Wear Indicator, on the tire's sidewalls identify tires that incorporate these wear indicators. Once the tire tread has worn down to the wear indicators, the tire has worn to a depth of 0.063 in/1.6 mm.

Wheel/tire damage

Please note that low-profile tires cause wheels, tires and suspension parts to be more susceptible to road hazard and consequential damages.

Unusual vibrations encountered during normal vehicle operation can indicate tire failure or some other vehicle defect. This can, for example, be caused by driving over curbs. The same applies to any other abnormal road behavior, such as pulling severely to the right or left.

 In these cases, reduce speed immediately and have wheels and tires thoroughly checked. To do so, drive carefully to the nearest BMW center or tire shop that works according to BMW repair procedures with correspondingly trained personnel. If necessary, have the vehicle towed there.

Otherwise, tire damage can pose a lethal hazard to vehicle occupants and other road users. ◀

Tire age

For various reasons, such as the development of brittleness, BMW recommends tire replacement after no more than 6 years, regardless of the actual wear of the tires.

The manufacturing date of tires is contained in the tire coding:

DOT ... 1010 means that the tire was manufactured in week 10 of 2010.

Run-flat tires



The symbol identifying run-flat tires is a circle with the letters RSC on the sidewall. Run-flat tires comprise a conditionally self-supporting tire and a special rim. The reinforcement in the sidewalls ensures that the tire can continue to be used subject to certain restrictions, even if depressurized.

For information on continuing to drive with a flat tire, refer to Indication of a flat tire, page 84.

New wheels and tires

 Have new wheels and tires installed only by your BMW center or tire shop that works according to BMW repair procedures with correspondingly trained personnel. If this work is not carried out properly, there is a danger of subsequent damage and related safety hazards. Make sure that the new wheels are balanced. ◀

Retreaded tires

 BMW recommends that you do not use retreaded tires, since driving safety may be impaired. The causes for this include potentially different tire casing structures and often wide variations in tire age, which can result in a limited service life. ◀

Correct wheels and tires

When mounting new tires or changing over from summer to winter tires and vice versa, mount run-flat tires for your own safety. In the event of a flat, no spare wheel is available. Your BMW center will be glad to advise you.

 BMW recommends that you use only wheel and tire combinations that BMW has tested and approved for your particular vehicle. Variations in factors such as manufacturing tolerances mean that even wheels and tires with identical official size ratings could actually have different dimensions, which could lead to body contact and thus to severe accidents. If non-approved wheels and tires are used, BMW cannot evaluate their suitability, and therefore cannot guarantee their driving safety. ◀

You can inquire about the right wheel/tire combination at your BMW center.

The correct combination of wheels and tires is also necessary to ensure reliable operation of various vehicle systems such as ABS, DSC or FTM.

To maintain good handling and vehicle response, use only tires of a single brand and tread configuration. After a tire has been damaged, mount the previous wheel and tire combination again as soon as possible.

Wheels with Tire Pressure Monitor TPM electronics

When mounting new tires or changing over from summer to winter tires, or vice versa, only use wheels with TPM electronics; otherwise, the Tire Pressure Monitor may not be able to detect a puncture, refer to page 84. Your BMW center will be glad to advise you.

Recommended tire brands

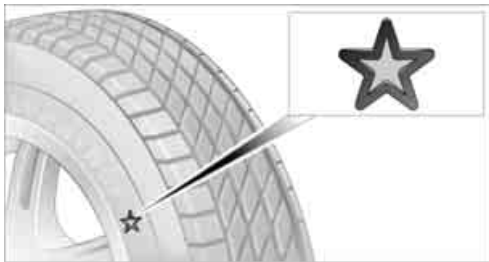

Certain makes of tire are recommended by BMW for each tire size. They are marked with a clearly visible BMW designation on the sidewall of the tire.

When properly used, these tires meet the highest standards in terms of safety and handling characteristics.

Special characteristics of winter tires

BMW recommends winter tires for driving on winter roads or at temperatures below +45°F/+7.6. Although all-season M+S tires provide better winter traction than summer tires, they generally fail to provide the same levels of cold-weather performance as winter tires.

Pay attention to speed

 Always comply with the speed limit for the winter tires mounted on your car; failure to do so could result in tire damage and accidents. ◀

If the car is capable of speeds higher than that permitted for the winter tires, a label stating the maximum permitted speed for the mounted tires must be displayed in your field of view. Specialist tire dealers and your BMW center can supply these labels.

Storage

Always store wheels and tires in a cool, dry place with as little exposure to light as possible. Always protect tires against all contact with oil, grease and fuels. Do not exceed the maximum tire inflation pressure indicated on the sidewall of the tire.

Swapping wheels between axles

BMW advises against swapping wheels between the front and rear axles, even if all tires have the same size, as this could impair driving characteristics. If the tires are of mixed sizes, swapping wheels between the axles is not permissible.

Snow chains*

Only certain fine-link snow chains have been tested by BMW, classified as safe for use and recommended. Consult your BMW center for more information.

Snow chains must be mounted in pairs and on the rear wheels only. Observe the manufacturer's instructions when mounting snow chains. Do not exceed a speed of 30 mph or 50 km/h.

 Do not initialize the Flat Tire Monitor if snow chains are mounted; otherwise, the instrument might issue an incorrect reading. When driving with snow chains, you may find it helpful to activate DTC temporarily, refer to page 81. ◀

Under the hood

! Do not work on the car unless you possess the necessary technical knowledge. If you are unfamiliar with the statutory guidelines, have any work on the vehicle performed only by a BMW center or by a workshop that work according to BMW repair procedures with correspondingly trained personnel. If this work is not carried out properly, there is a danger of subsequent damage and related safety hazards. ◀

Hood

Releasing

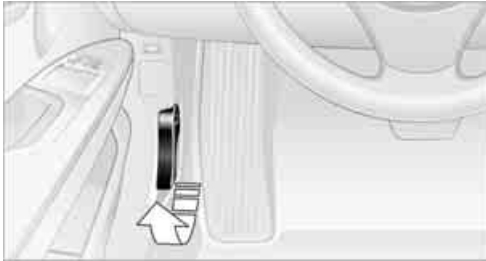

Pull the lever.

Opening



! In order to avoid damage, make sure that the wiper arms are against the windshield before you open the hood. Do not open the engine hood before the engine has cooled down; otherwise, injuries may result. ◀

Press the release handle and open the hood.

Closing



Let the hood drop from a height of approx. 10 in/25 cm. It must be clearly heard to engage.

! Make sure that the closing path of the hood is clear; otherwise, injuries may result.

If you see any signs while driving your vehicle that the hood is not completely closed, stop at once and close it securely. ◀

Important parts of the engine compartment



- 1 Expansion tank for coolant, refer to page 147
- 2 Washer fluid filler neck for headlamp cleaning system and window washer system, refer to page 62
- 3 Jump-starting connection, refer to page 160
- 4 Filler neck for engine oil, refer to Adding engine oil

Engine oil

The engine oil consumption is dependent on driving style and driving conditions.

Checking oil level

Your car is equipped with an electronic oil-level monitor.

For a precise measurement and display of the oil level, it is necessary that the engine be at operating temperature, i.e. after uninterrupted driving for at least approx. 6.2 miles/10 km. You can have the oil level displayed while you are driving, or while the vehicle is at a standstill on a level surface and the engine is running.

You can have the oil level reading displayed in the instrument cluster.



1. Push button 1 in the turn indicator lever up or down repeatedly until the appropriate symbol is shown in the display, accompanied by the word "OIL".
2. Press button 2 in the turn indicator lever. The oil level is checked and the reading displayed.

Possible displays



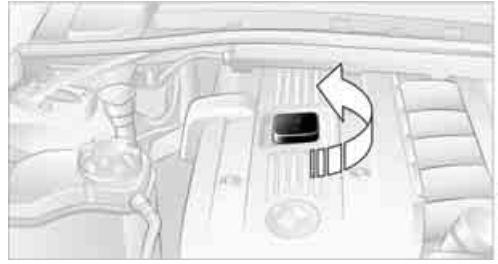

- 1 Oil level OK
- 2 Oil level is being checked.
This can take about 3 minutes if the car is at a standstill on a level surface, or about 5 minutes while the car is on the move.
- 3 Oil level down to minimum:
Add engine oil as soon as possible, but no more than 1 US quart/1 liter, refer also to Adding engine oil on page 146.
- 4 Oil level is too high.
 Too much oil will harm the engine. Have the vehicle checked without delay. ◀
- 5 The oil level sensor is defective.
Do not add engine oil. You can continue your journey. Note the newly calculated distance remaining to the next oil service, refer to page 76. Have the system checked as soon as possible.

Adding engine oil



Do not add 1 US quart/1 liter of engine oil until the following warning lamp lights up in the instrument cluster, or until the oil level monitor shows "+1 qt" or "+1".



-  Add oil within the next 125 miles/200 km; otherwise, the engine could be damaged. ◀
-  Keep oils, greases, etc. out of the reach of children and comply with the relevant warnings on the containers. Otherwise, health hazards may result. ◀

Oil change

Have oil changed only at your BMW center or at a workshop that works according to BMW repair procedures with correspondingly trained personnel.

Oil types

 Do not use oil additives as this could result in engine damage. ◀

Specified engine oils

Your service center can advise you on which engine oils have been approved by the manufacturer of your vehicle.

The engine oil quality is critical for the life of the engine.

Approved oils can be identified by the following specification:

Gasoline engine

Preferred: BMW Longlife-01
BMW Longlife-01 FE

Alternatively: BMW Longlife-98

Approved oils belong to the following viscosity classes: SAE 0W-40, SAE 0W-30, SAE 5W-40 and SAE 5W-30.

Alternative oil types

If approved oils are not available, you can use quantities of up to 1 US quart/1 liter of another oil with the following specifications:

API SM or higher

BMW recommends 

Coolant

 Do not add coolant to the cooling system when the engine is hot. Escaping coolant can cause burns. ◀

Coolant consists of half water and half additive. Not all commercially available additives are suitable for your BMW. Ask your BMW center for suitable additives.

 Only use suitable additives; otherwise, engine damage may result. Because additives are harmful to your health, it is important to follow the instructions on the containers. ◀

 Comply with the appropriate environmental protection regulations when disposing of coolant additives. ◀

Checking coolant level

1. Do not open the engine hood before the engine has cooled down.
2. Turn the cap of the expansion tank a little counterclockwise to allow any accumulated pressure to escape, then continue turning to open.
3. The coolant level is correct if it is between the maximum and minimum marks in the filler neck, refer also to the diagram next to the filler neck.



4. If the coolant is low, slowly add coolant up to the specified level; do not overfill.
5. Turn the cap until there is an audible click.
6. Have the reason for the coolant loss eliminated as soon as possible.

Maintenance

BMW Maintenance System



The BMW Maintenance System supports the preservation of the traffic and operating safety of your BMW. The objective is to optimize efforts with respect to minimal vehicle maintenance costs.

If and when you come to sell your BMW, a comprehensive record of servicing will prove a significant benefit.

Condition Based Service CBS

Sensors and special algorithms take the different driving conditions of your BMW into account. Condition Based Service uses this to determine the current and future service requirements. By letting you define a service and maintenance regimen that reflects your own individual requirements, the system builds the basis for trouble-free driving.

In the instrument cluster, you can have the remaining times or distances for selected maintenance tasks and any legally prescribed dates displayed, refer to page 76:

- ▷ Engine oil
- ▷ Brake pads: separately for front and rear
- ▷ Brake fluid
- ▷ Vehicle check
- ▷ Legally mandated inspections depending on local regulations

Service data in the remote control

Your vehicle continuously stores service-requirement information in the remote control while you are driving. Your BMW Service Advisor can read out this data from the remote control unit, and propose an optimized maintenance approach. Whenever you take your car in for servicing you should therefore hand your BMW Service Advisor the remote control unit that you last used.

 Make sure that the date in the instrument cluster is always set correctly, refer to page 77; otherwise, the effectiveness of Condition Based Service CBS is not assured. ◀

Service and Warranty Information Booklet for US models and Warranty and Service Guide Booklet for Canadian models

Please consult your Service and Warranty Information Booklet for US models and Warranty and Service Guide Booklet for Canadian models for additional information on service requirements.

 BMW recommends that you have service and repair operations performed at your BMW center.

Take the time to ensure that these service procedures are confirmed by entries in your vehicle's Service and Warranty Information Booklet for US models and Warranty and Service Guide Booklet for Canadian models. These entries verify that your vehicle has received the specified regular maintenance. ◀

Socket for Onboard Diagnosis OBD

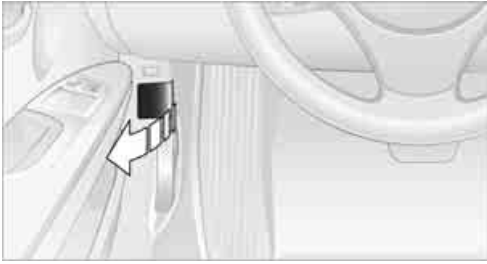

On the driver's side is an OBD socket for checking components relevant to the composition of the vehicle's emissions.

Emissions

SERVICE ENGINE SOON The warning lamp lights up: The vehicle is producing higher emissions. The trip can be continued. Have the car checked as soon as possible.



Canadian models display this warning lamp.

The lamp flashes under certain conditions. This indicates excessive misfiring in the engine. If this happens, you should reduce your speed and visit your nearest BMW center as soon as possible. Severe engine misfiring can quickly lead to serious damage of emissions-related components, especially the catalytic converter.



The warning lamp comes on if the gas cap is not properly tightened and the OBD system assumes that fuel vapor is escaping. Make sure that the gas cap is correctly positioned and close it until it audibly clicks.

Data memory

Your vehicle records data about the operation, faults, and user settings. These data are stored in the vehicle and in extract form, in the remote control, and can be read out using suitable devices at your BMW center. The data that are read out are used to support service procedures and repairs or to optimize and expand vehicle functions. If you have a BMW Assist contract, certain vehicle data can also be transmitted directly from the vehicle in order to enable the desired services.

Care

Care products

Regular cleaning and care contributes significantly to the value retention of your BMW.

BMW recommends cleaning and caring for your vehicle with products that are approved by BMW for this purpose.

Your BMW center will be happy to advise you on the products and services available for cleaning and caring for your BMW.

 Original BMW Care Products have been material tested, laboratory checked and proven in the field, and offer optimal care and protection for your vehicle. ◀

 Do not use cleaners that contain alcohol or solvents as these may result in damage. ◀

 Cleaning agents can contain substances that are dangerous or hazardous to your health. Therefore, follow the warning and safety instructions on the packaging. When cleaning inside the vehicle, always open the doors or windows of the vehicle. In enclosed areas, provide for sufficient ventilation. Only use products designed for cleaning vehicles. ◀

Exterior care

Washing the vehicle

 Especially during the winter months, ensure that the vehicle is washed more frequently. Heavy soiling and road salt can lead to vehicle damage. ◀

 After washing the vehicle, apply the brakes briefly to dry them; otherwise, water can reduce braking efficiency over the short term and the brake discs can corrode. ◀

Automatic car washes

Preference should be given to cloth car washes.

 Do not use high-pressure car washes; otherwise, water may drip into the vehicle around the windows. ◀

Before driving into a car wash, ensure that it is suitable for your BMW. Check the following:

- ▷ Dimensions of your vehicle, refer to page 179.
- ▷ If necessary: fold in the exterior mirrors, refer to page 44.
- ▷ Maximum permissible tire width.

 Avoid car washes with guide rail heights over 4 in/10 cm; otherwise, there is the danger of damaging chassis parts. ◀

Preparations before driving into an automatic car wash:

- ▷ Unscrew the rod antenna*.
- ▷ Deactivate the rain sensor* to prevent unintentional wiping.
- ▷ Remove additional add-on parts, e.g. spoilers or phone antennas, if they could be damaged.

Automatic transmission

Before driving into an automatic car wash, perform the following steps to ensure that the vehicle can roll:

1. Insert the remote control into the ignition lock, even with Comfort Access.
2. Move the selector lever to position N.
3. Release the parking brake.
4. Switch off the engine.
5. Leave the remote control in the ignition lock so that the vehicle can roll.

Sports automatic transmission with double clutch

Before driving into an automatic car wash, perform the following steps to ensure that the vehicle can roll:

1. Insert the remote control into the ignition lock, even with Comfort Access.
2. Engage transmission position N.
3. Release the parking brake.
4. Switch off the engine.
5. Leave the remote control in the ignition lock so that the vehicle can roll.

The transmission is switched into position P:

- ▷ automatically after approx. 30 minutes
- ▷ if you remove the infrared remote control from the ignition lock

Steam jets/high-pressure washers

 When using steam jets or high-pressure washers, ensure that you maintain sufficient clearance to the vehicle and do not exceed a temperature of 140 °F /60 °C.

Insufficient clearance or excessive pressure or temperature can lead to component damage or water penetration. Follow the operating instructions of the high-pressure washer. ◀

 When using high-pressure washers, do not spray against the sensors and cameras, e.g. of the Park Distance Control or Rear View Camera, for an extended period and maintain a distance of at least 1 ft/30 cm. ◀

Manual car wash

When washing the vehicle by hand, use large quantities of water and car shampoo if necessary. Clean the vehicle with a sponge or washing brush, applying light pressure only.

 Before cleaning the windshield, deactivate the rain sensor or switch off the ignition to prevent unintentional activation of the wipers. ◀

 Observe local regulations pertaining to washing vehicles by hand. ◀

Headlamps

Do not rub them dry and do not use abrasive or corrosive cleaning agents.

Loosen dirt, e.g. insects, with shampoo or insect remover and wash away with copious quantities of water.

Thaw ice with a windshield deicer and do not use an ice scraper.

Windows

Clean the inside and outside surfaces of the windows and the mirrors with window cleaner.

 Do not clean the mirrors with cleaners containing quartz. ◀

Convertible: retractable hardtop

Proceed as you would in a normal car wash.

 When you open a wet hardtop, water drops may run into the cargo area. If necessary, remove items from the cargo area beforehand to avoid water stains or soiling. ◀

Paintwork care

Regular care contributes to value retention and protects the paintwork against the long-term effects of damaging substances.

Region-specific environmental influences can damage the vehicle paintwork. Therefore, it is important to adapt the frequency and scope of car care accordingly.

Immediately remove aggressive materials such as spilled fuel, oil, grease, brake fluid, tree sap or bird droppings to prevent damage to the paintwork.

Repairing paintwork damage

 Immediately repair scratches or similar damage, such as that caused by stones hitting the vehicle, where necessary to prevent rusting. ◀

BMW recommends having paintwork damage repaired by a professional paint repair workshop according to BMW specifications using original BMW paint materials.

Preservation

A preservation treatment is necessary when water no longer beads off the clean paintwork surface. Only use products for paintwork preservation that contain carnauba or synthetic waxes.

Rubber seals

Treat only with water or rubber care products.

 Do not use silicon-containing care products on rubber seals; otherwise, noise and damage could occur. ◀

Chrome parts

Carefully clean vehicle parts such as the radiator grill, door handles or window frames with copious quantities of water and a shampoo additive, especially when roads are treated with deicing salt. For additional treatment, use a chrome polish.

Light-alloy wheels

For technical reasons, dust is generated during braking that is deposited on the light-alloy wheels. Remove the dust regularly using acid-free rim cleaner.

 Do not use aggressive, acidic, strongly alkaline and abrasive cleaning agents or steam jets over 140 °F /60 °C; otherwise, damage may occur. ◀

Outside sensors/cameras

 Keep the sensors and cameras on the outside of the vehicle, e.g. those for Park Distance Control, clean and free of ice to ensure that they remain fully functional. ◀

Interior care

Upholstery fabrics/cloth trims/ Alcantara fabrics

Vacuum regularly with a vacuum cleaner to remove superficial dirt.

To remove severe spots such as stains from beverages, use a soft sponge or lint-free microfiber cloth and suitable interior cleaners. Follow the instructions on the packaging.

 Clean the upholstery down to the seams using a sweeping motion. Avoid strong rubbing. ◀

 Opened Velcro fasteners on pants or other articles of clothing can damage the seat covers. Ensure that Velcro fasteners are closed. ◀

Leather/leather trim

 The leather used by BMW is a high quality natural product. Slight irregularities in the leather are a typical characteristic of natural leather. ◀

Dust and road grit in the pores and folds of the leather have an abrasive effect, leading to increased wear and causing the leather surface to become brittle prematurely. Therefore, frequently clean the leather of dust using a cloth or vacuum cleaner.

Clean light-colored leather more frequently as dust and dirt are more noticeable.

Treat the leather at least once every two months using a leather lotion as dirt and grease will gradually attack the leather's protective layer.

Carpet/floor mats*

The floor mats can be removed for cleaning. When heavily soiled, clean carpets with a microfiber cloth and water or textile cleaner. Rub back and forth in the direction of travel; otherwise, the carpet may become matted.

Interior plastic parts

- ▷ Imitation leather surfaces
- ▷ Lamp glasses
- ▷ Display pane of instrument cluster
- ▷ Matte parts

Clean with water and solvent-free plastic cleaner if necessary.

Fine wood parts

Clean fine wood trim and fine wood parts with a damp cloth. Wipe dry with a soft cloth.

Safety belts

Dirty belt straps impede the reeling action and thus have a negative impact on safety.

 Do not clean chemically, as this may destroy the webbing. ◀

Interior sensors/cameras

To clean interior sensors and cameras, use a lint-free cloth moistened with glass cleaner.

Displays

To clean displays, e.g. of the radio or instrument cluster, use a cleaning cloth for displays or a soft, non-abrasive, lint-free cloth.

 Avoid applying excessive pressure when cleaning the displays; otherwise, damage may occur. ◀

 Do not use chemical or abrasive household cleaning agents. Keep all types of fluid away from the device. Otherwise, surfaces or electrical components may be corroded or damaged. ◀

CD/DVD drives

 Do not use a cleaning CD, as it may damage parts of the drive. ◀

Vehicle storage

If your vehicle is to be decommissioned for longer than three months, your BMW center or a workshop that operates according to BMW specifications will be glad to advise you.

Replacing components

Onboard vehicle tool kit

Coupe



The onboard vehicle tool kit is stored in a compartment on the right-hand side of the cargo area. Remove the cover.

Convertible

The onboard vehicle tool kit is stored in a pouch under the cargo area floor panel.

Wiper blades

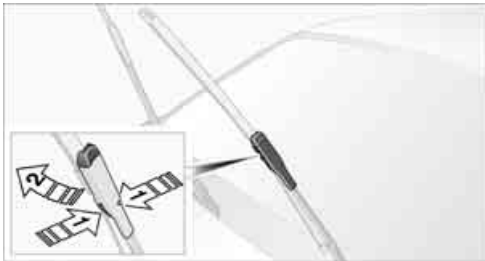

1. Fold out the wiper arm and hold it.
2. Press together the locking spring, arrows **1**, and fold out the wiper blade, arrow **2**.
3. Take the wiper blade out of the catch mechanism, pulling the blade toward the front.

! To avoid damage, make sure that the wiper arms are against the windshield before you open the engine compartment. ◀

Lamps and bulbs

Lamps and bulbs make an essential contribution to vehicle safety. They should, therefore, be handled carefully. BMW recommends having your BMW center perform any work that you do not feel competent to perform yourself or that is not described here.

▷ Never touch the glass of new bulbs with your bare fingers, as even minute amounts of contamination will burn into the bulb's surface and reduce its service life. Use a clean tissue, cloth or something similar, or hold the bulb by its base. ◀

You can obtain a selection of replacement bulbs at your BMW center.

! Only change bulbs while they are cool to the touch; otherwise, you could suffer burns. ◀

! When working on electrical systems, always begin by switching off the consumer in question; otherwise, short-circuits could result. To avoid possible injury or equipment damage when replacing bulbs, observe any instructions provided by the bulb manufacturer. ◀

For care of the headlamps, please follow the instructions in the chapter entitled 'Care'.

▷ If the routine for changing a particular bulb is not described here, please contact your BMW center or a workshop that works according to BMW repair procedures with correspondingly trained personnel. ◀

Light-emitting diodes LED

Light-emitting diodes installed behind translucent lenses serve as the light source for many of the controls, displays, and equipment in your vehicle. These light-emitting diodes, which operate using a concept similar to that applied in conventional lasers, are officially designated as Class 1 light-emitting diodes.

 Do not remove the covers or expose the eyes directly to the unfiltered light source for several hours; otherwise, this could cause irritation of the retina. ◀

Headlight lenses

In cool or humid weather, condensation may form on the interior of outside lamps. When the light is switched on, the condensation will disappear after a short time. The headlight lenses do not need to be replaced.

At high humidities, e.g. water droplets may form in the lights; have these checked by your BMW center.,

Xenon lamps

These bulbs have a very long service life and are highly unlikely to fail. If a xenon lamp fails nevertheless, switch on the fog lamps and continue the journey with great care, provided that local legislation does not prohibit this.

 Have any work on the xenon lamp system, including bulb replacements, performed only by a BMW center or a workshop that works according to BMW repair procedures with correspondingly trained personnel. Otherwise, if such work is carried out improperly, the high voltage in the system presents the danger of fatal injuries. ◀

Access to the lamps

1. Switch off the lamps and take the remote control out of the ignition lock.
2. Remove the upper cover from the headlamp. To do so, use a screwdriver to press the catches towards the rear, see arrows, and pull the cover forward and out.

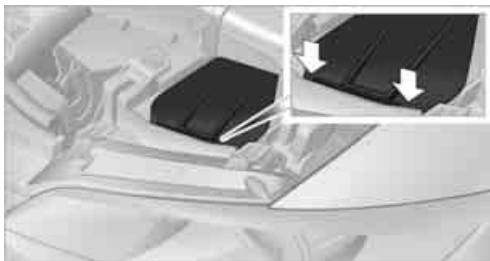

Follow the same steps in reverse order to reattach the cover.

 Be careful when installing the cover; otherwise, leaks could occur and cause damage to the headlamp system. ◀

Parking lamps and roadside parking lamps, daytime running lights*

These lamps use LED technology for operation. If they malfunction, please contact your BMW center.

Corner-illuminating lamp*

H3 bulb, 55 watts

1. Switch off the lamps and take the remote control out of the ignition lock.
2. Remove the cover, refer to Access to the lamps.
3. Push the wire bracket out of the anchor towards the right and fold it up.

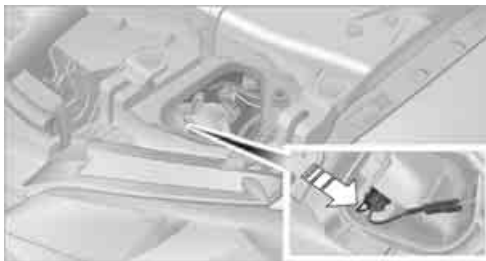

4. Disconnect the plug, change the bulb and reconnect the plug.
5. Insert the bulb.
6. Fold the wire bracket down and engage it.
7. Reattach the cover.

Turn signals, front

These lamps use LED technology for operation. If they malfunction, please contact your BMW center.

Side turn signals

W5W bulb, 5 watts

1. Press the front edge of the lamp toward the rear with your fingertip, arrow **1** and pivot it out, arrow **2**.

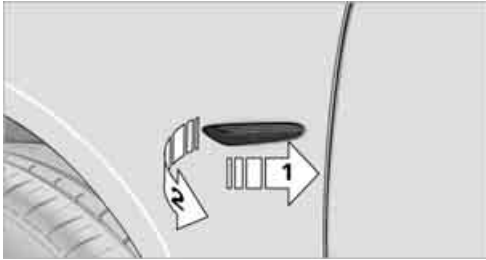

2. While simultaneously lifting the retaining tab, rotate bulb holder to the left and remove.
3. Remove lamp and replace it.

To install, insert rear end of the lamp and press into place at the front.

Tail lamps

Coupe: at a glance

The tail lamps are divided in two parts. One part is in the trunk lid, the other is in the fender.

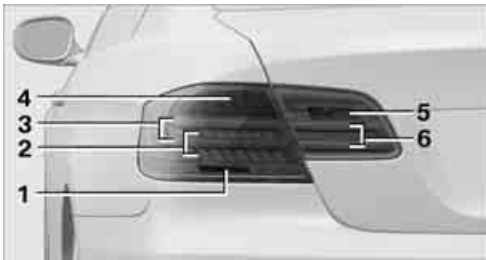

- 1 Backup lamp
- 2 Brake lamp
- 3 Parking/tail lamps
- 4 Turn signal
- 5 Brake Force Display lamp
- 6 Parking/tail lamps

Convertible: at a glance

The tail lamps are divided in two parts. One part is in the trunk lid, the other is in the fender.

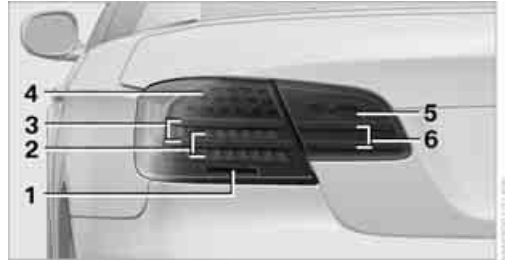

- 1 Backup lamp
- 2 Brake lamp
- 3 Parking/tail lamps
- 4 Turn signal
- 5 Brake Force Display lamp
- 6 Parking/tail lamps

Backup lamp

If these lamps malfunction, please contact your BMW center.

Turn signal, brake, license plate, parking, and tail lamps

These lamps use LED technology for operation. If they malfunction, please contact your BMW center.

Coupe: two-stage brake light in the trunk lid

H21W bulb, 21 watts

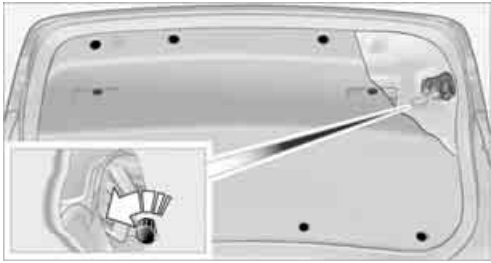

1. Pry out the plastic plugs in the trim of the trunk lid using a screwdriver and remove the trim.
2. Release the bulb holder, see arrow, and remove.
3. Apply gentle pressure to the bulb while turning it to the left for removal and replacement.
4. Attach the bulb holder.
5. Attach trunk lid trim.

Convertible: two-stage brake light in the trunk lid

H21W bulb, 21 watts

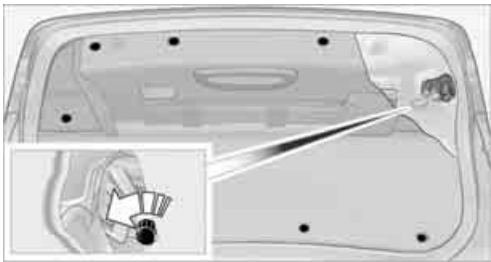

1. Take the warning triangle out of its holder, refer to page 160. Unscrew the holder using the screwdriver from the onboard vehicle tool kit.
2. Pry out the plastic plugs in the trim of the trunk lid using a screwdriver and remove the trim.
3. Release the bulb holder, see arrow, and remove.

4. Apply gentle pressure to the bulb while turning it to the left for removal and replacement.
5. Attach the bulb holder.
6. Reattach the trim of the trunk lid and the holder for the warning triangle.

Changing wheels

Your BMW is equipped with run-flat tires as standard. This eliminates the need to change a wheel immediately in the event of a puncture.

For information on continuing to drive with a damaged tire, refer to Indication of a flat tire on page 84.

The symbol identifying run-flat tires is a circle with the letters RSC on the sidewall, refer to Run-flat tires, page 142.

When mounting new tires or changing over from summer to winter tires and vice versa, mount run-flat tires for your own safety. In the event of a flat, no spare wheel is available. Your BMW center will be glad to advise you. Refer also to New wheels and tires, page 142.

 The tools for changing wheels are available as optional accessories from your BMW center. ◀

Jack mounting points

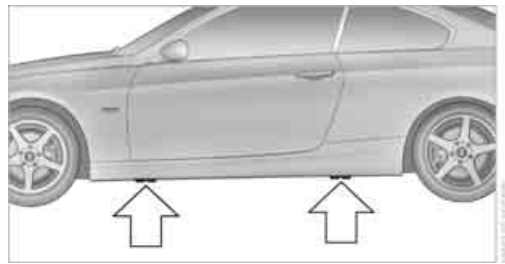

The jacking points are at the positions shown in the illustration.

Vehicle battery

Battery care

The battery is 100% maintenance-free, the electrolyte will last for the life of the battery when the vehicle is operated in a temperate climate. Your BMW center will be glad to advise in all matters concerning the battery.

Battery replacing

 Only use vehicle batteries that have been approved for your vehicle by the manufacturer; otherwise, the vehicle could be damaged and systems or functions may not be fully available. ◀

After a battery replacement, have the battery registered on the vehicle by your service center to ensure that all comfort functions are fully available.

Charging the battery

Only charge the battery in the vehicle via the terminals in the engine compartment with the engine off. Connections, refer to Jump-starting on page 160.

Disposal

 Have old batteries disposed of by your BMW center or bring them to a recycling center. Maintain the battery in an upright position for transport and storage. Always secure the battery against tipping over during transport. ◀

Power failure

After a temporary power loss, the functioning of some equipment may be limited and require reinitialization. Individual settings may likewise have been lost and will have to be programmed:

- ▷ Time and date
These values must be updated, refer to page 77.
- ▷ Radio
Stations must be stored again, refer to the separate Owner's Manual for Radio.

- ▷ Glass roof
It may happen that the roof can only be raised. The system must be initialized. Please contact your BMW center.
- ▷ Seat and mirror memory
The positions must be stored again, refer to page 41.
- ▷ Inside rearview mirror with digital compass
The system must be calibrated, refer to page 107.
- ▷ Active steering
The system automatically initializes itself briefly during a trip. The system is deactivated during this time, refer to page 87.
- ▷ xDrive
The system automatically initializes itself during a trip. Indicator lamps light up during this time. If the lamps do not go out during the current trip, have the system checked.

Fuses

 Never attempt to repair a blown fuse and do not replace a defective fuse with a substitute of another color or amperage rating; otherwise, this could lead to a circuit overload, ultimately resulting in a fire in the vehicle. ◀



Open the cover in the glove compartment and remove it.

Plastic tweezers are located on the distributor box. See the rear of the cover for information on fuse assignment.

Spare fuses are available from your BMW center.

Giving and receiving assistance

Emergency Request*

Conditions for an Emergency Request:

- ▶ Full preparation package mobile phone: this equipment makes it possible to send an Emergency Request even if no mobile phone is paired with the vehicle.
- ▶ BMW Assist is activated. Activating BMW Assist, refer to separate Owner's Manual.
- ▶ Radio readiness is on.
- ▶ The BMW Assist system is logged on to a mobile phone network.
- ▶ The Emergency Request system is operable.

Once your service contract for BMW Assist expires, the BMW Assist system can be deactivated by a BMW center without you having to visit a workshop. Once the BMW Assist system has been deactivated, Emergency Requests are not possible. The BMW Assist system can be reactivated by a BMW center after a new contract has been signed.

Sending an Emergency Request

1. Briefly press the cover flap to open.



2. Press the SOS button until the LED in the button lights up.

As soon as the voice connection to the BMW Assist Response Center has been established, the LED flashes.

Once the BMW Assist Response Center has received your Emergency Request, the BMW Assist Response Center contacts you and takes further steps to help you. Even if you are unable to respond, the BMW Assist Response Center will be able to initiate further steps to assist you under certain conditions.

If the circumstances allow this, remain in the vehicle until the connection has been established. You will then be able to provide a detailed description of the situation.

Data for determining the necessary rescue measures are transmitted to the BMW Assist Response Center, e.g. the current position of your vehicle, if it can be determined.

If the LED is flashing but the BMW Assist Response Center cannot be heard over the hands-free system, it is possible that the hands-free system is malfunctioning. You may still be heard by the BMW Assist Response Center, however.

Under certain conditions, an Emergency Request is sent automatically immediately after a severe accident. This Automatic Collision Notification is not affected by the button being pressed.

 For technical reasons, the Emergency Request service cannot be guaranteed for the most unfavorable conditions. ◀

Roadside Assistance

BMW Roadside Assistance is available by phone around the clock in many countries. You can obtain support there in the event of a breakdown.

Phone numbers for BMW Roadside Assistance can be found in the Contact brochure.

First aid pouch*

Some of the articles contained in the first aid pouch have a limited service life. Therefore, check the expiration dates of the contents regularly and replace any items in good time, if necessary.

Coupe



The first aid pouch is located on the right-hand side of the cargo area in a storage area.

Convertible



The first aid pouch is located in a compartment under the front passenger seat.

To open: press the button and fold the cover down.

To close: fold the cover back up and press it into the catch.

Warning triangle*

Coupe

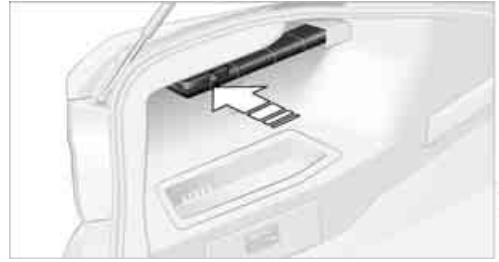

The warning triangle is located on the left-hand side of the cargo area. Press the tab to take it out.

Convertible

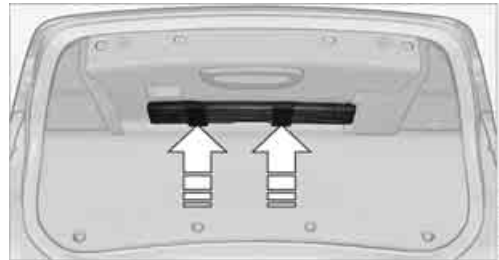

The warning triangle is located in a holder in the trunk lid. Press the tabs to take it out.

Jump-starting

If the car's own battery is flat, your BMW's engine can be started by connecting two jumper cables to another vehicle's battery. You can also use the same method to help start another vehicle. Only use jumper cables with fully-insulated clamp handles.



Do not touch any electrically live parts when the engine is running, or a fatal accident may occur. Carefully adhere to the following sequence, both to prevent damage to one or both vehicles, and to guard against possible personal injuries. ◀

Preparation

1. Check whether the battery of the other vehicle has a voltage of 12 volts and approximately the same capacitance in Ah. This information can be found on the battery.
2. Switch off the engine of the assisting vehicle.
3. Switch off any consumers in both vehicles.

 There must not be any contact between the bodies of the two vehicles; otherwise, there is a danger of shorting. ◀

Connecting jumper cables

 Connect the jumper cables in the correct order, so that no sparks which could cause injury occur. ◀

Your BMW has a jump-starting connection in the engine compartment which acts as the battery's positive terminal, refer also to the Engine compartment overview on page 145. The cap is marked with +.

1. Pull the cap of the BMW jump-starting connection up to remove.



2. Attach one terminal clamp of the plus/+ jumper cable to the positive terminal of the battery or a starting-aid terminal of the vehicle providing assistance.
3. Attach the second terminal clamp of the plus/+ jumper cable to the positive terminal of the battery or a starting-aid terminal of the vehicle to be started.
4. Attach one terminal clamp of the minus/- jumper cable to the negative terminal of the battery or to an engine or body ground of the assisting vehicle.

Your BMW has a special nut as body ground or negative pole.

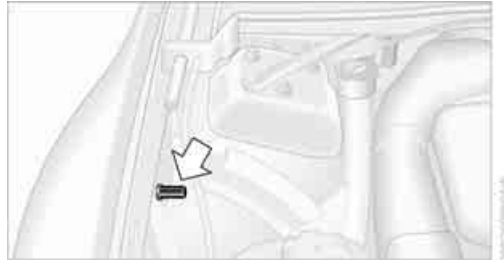

5. Attach the second terminal clamp of the minus/- jumper cable to the negative terminal of the battery or to the engine or body ground of the vehicle to be started.

Starting the engine

1. Start the engine of the donor vehicle and allow it to run for a few minutes at slightly increased idle speed.
2. Start the engine on the other vehicle in the usual way.
If the first start attempt is not successful, wait a few minutes before another attempt in order to allow the discharged battery to recharge.
3. Let the engines run for a few minutes.
4. Disconnect the jumper cables by reversing the above connecting sequence.

If necessary, have the battery checked and recharged.



Never use spray fluids to start the engine. ◀

Tow-starting, towing away

 Observe the applicable laws and regulations for tow-starting and towing vehicles. ◀

 Do not transport any passengers other than the driver in a vehicle that is being towed. ◀

Using a tow fitting

The screw-in tow fitting must always be carried in the car. It can be screwed in at the front or rear of the BMW.

Coupe: it is stored in the onboard vehicle tool kit underneath the cover on the right-hand side of the cargo area, refer to page 154.

Convertible: it is stored in the onboard vehicle tool kit underneath the cargo area floor, refer to page 154.

 Use only the tow fitting provided with the vehicle and screw it all the way in. Use the tow fitting for towing on paved roads only. Avoid lateral loading of the tow fitting, e.g. do not lift the vehicle by the tow fitting. Otherwise, the tow fitting and the vehicle could be damaged. ◀

Access to screw thread

Release the cover panel in the bumper:
Press on the upper part of the cover panel.

Front

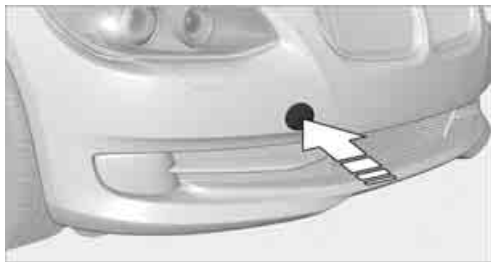

Rear

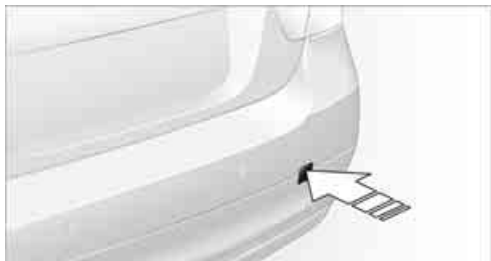

Being towed

 Make sure that the ignition is switched on, refer to page 50; otherwise, the low-beam headlamps, tail lamps, turn signal indicators and windshield wipers may be unavailable.

Power steering assistance is not available when the engine is not running. Thus, braking and steering will require increased effort. Active steering is not active and it will be necessary to turn the steering wheel further. ◀

Manual transmission

Gearshift lever in neutral position.

Automatic transmission

Selector lever in position N.

Changing selector lever positions, refer to page 53.

 Do not exceed a towing speed of 45 mph or 70 km/h and a towing distance of 90 miles/150 km; otherwise, the automatic transmission may be damaged. ◀

Sports automatic transmission with double clutch

 Make sure that the parking lock P is not engaged; otherwise, the rear wheels are immobilized.

When using the car wash function, refer to page 151, make sure that after approx.

30 minutes, the parking lock P is automatically engaged and thus immobilizes the rear wheels.

In the event of an electrical malfunction or if the vehicle must be towed for more than approx.

20 minutes, unlock the parking lock manually, refer to page 58. ◀

 When towing, do not exceed a maximum speed of 30 mph or 50 km/h and a maximum distance traveled of 30 miles/50 km; otherwise, the transmission may be damaged. ◀

BMW recommends transporting the vehicle on a tow truck with a flatbed or towing with the rear axle raised.

Towing methods

 Do not lift the vehicle by a tow fitting or body and chassis parts; otherwise, damage may result. ◀

With a tow bar

 The towing vehicle must not be lighter than the towed vehicle; otherwise, it may be impossible to maintain control. ◀

The tow fittings used should be on the same side on both vehicles. Should it prove impossible to avoid mounting the tow bar at an angle, please observe the following:

- ▶ Clearance and maneuvering capability will be sharply limited during cornering.
- ▶ The tow bar will generate lateral forces if it is attached offset.

 Attach the tow bar to the tow fittings only, as attaching it to other parts of the vehicle could result in damage. ◀

With a tow rope

When starting off in the towing vehicle, make sure that the tow rope is taut.

 To avoid jerking and the associated stresses on vehicle components when towing, always use nylon ropes or nylon straps. Attach the tow rope to the tow fittings only, as attaching it to other parts of the vehicle could result in damage. ◀

With a tow truck: vehicle without xDrive

Manual and automatic transmission:

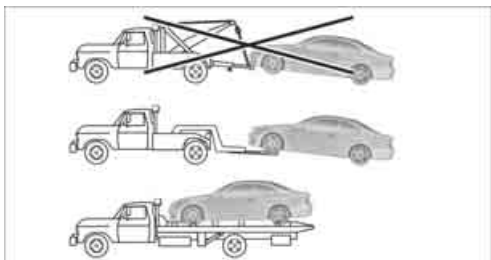

Sports automatic transmission with double clutch:

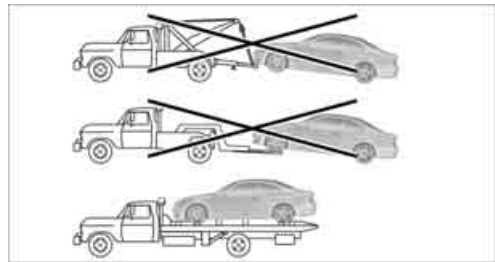

Have the BMW transported with a tow truck with a so-called lift bar, or on a flatbed.

Do not tow the vehicle with just the rear axle raised as this may cause the steering to turn.

With a tow truck: vehicle with xDrive

 Do not tow a BMW with xDrive with just the front or rear axle raised; otherwise, the wheels could lock up and the transfer case could be damaged. ◀

Have the BMW transported on a flatbed surface only.

Tow-starting

Avoid tow-starting the vehicle whenever possible; instead, jump-start the engine, refer to page 160. Vehicles with a catalytic converter should only be tow-started when the engine is cold; vehicles with an automatic transmission or Sports automatic transmission with double clutch cannot be tow-started at all.

1. Switch on hazard warning flashers, comply with local regulations.
2. Switch on the ignition, refer to page 50.
3. Shift into 3rd gear.
4. Have the vehicle tow-started with the clutch depressed and slowly release the clutch. After the engine starts, immediately depress the clutch completely again.
5. Stop at a suitable location, remove the tow bar or rope and switch off the hazard warning flashers.
6. Have the vehicle checked.









 With xDrive: do not activate Hill Descent Control HDC when the vehicle is being tow-started, page 82. ◀









Indicator and warning lamps















Indicator and warning lamps can light up in a variety of combinations and colors. See the table for information on causes and how to react. Note whether a lamp comes on alone or in combination with another. Some lamps can light up in different colors. Corresponding distinctions are made in the text.



















1	2	Cause	What to do
		Turn signals	
		High beams/headlamp flasher switched on	
		Fog lamps switched on	
		Fasten safety belts	Fasten your safety belt, refer also to page 43.
BRAKE		Indication in US models Parking brake applied	Release the parking brake.
		Indication in Canadian models Parking brake applied	Release the parking brake.
		Outside temperature warning	Drive cautiously, refer also to page 71.
		Lights up briefly: Approx. 2.1 US gallons/8 liters of fuel remain in the tank Remains on: Remaining operating range is no more than 30 miles/50 km, refer to page 72	
		Engine refuses to start	Depress the brake or clutch in order to start the engine, refer to page 51.
		Ignition switched on and driver's door open	Switch off the ignition, refer to page 50, or close the driver's door.
		Parking lamps still on	Switch off the parking lamps, refer to page 91.
		Roadside parking lamps still on	Switch off the roadside parking lamps, refer to page 93.





















1	2	Cause	What to do
	Door open		
	Engine compartment lid open		
	Lights up in red: Backrest of driver's seat or front passenger seat not locked		Lock the backrest; otherwise, the safety belt will not provide protection in the event of an accident.
	Lights up in yellow: Seat backrest monitor malfunctioning		Engage the seat backrest. Have it checked by your nearest BMW center.
	Lights up in red: Roof activation system failure		Roof cannot be moved. If the retractable hardtop does not lock, contact your nearest BMW center.
	Roof activation system malfunctioning		Roof movement incomplete. Please check if the roof is blocked, then press or pull the switch again.
	Lights up in yellow: Roof drive overheated		Roof activation temporarily limited to closing only.
	Cargo area partition not in lowermost position		Press down the cargo area partition until it engages on both sides.
	Vehicle not level, roof activation not possible		Move the vehicle to a level surface.
	Rollover protection system malfunctioning		Have the rollover protection system checked by your nearest BMW center.
	Trunk lid open		
	Gas cap is open		Make sure that the gas cap is correctly positioned and close it until it audibly clicks. Do not jam the strap between the gas cap and the vehicle.
	Windshield washer fluid level too low		Add washer fluid as soon as possible, refer to page 62.







1	2	Cause	What to do
	Lights up in red: Service due		Arrange a service appointment. Check service requirements, refer to page 76.
	Lights up in yellow: The engine will start the next time the start/stop button is touched, possibly without the brake or clutch being depressed		
	Remote control malfunctioning or, in cars with Comfort Access, not detected		The engine cannot be started. Have the remote control checked, if necessary.
	Battery in remote control discharged		Use the remote control for a longer journey or, in cars with Comfort Access, replace the battery.
	Belt tensioners and/or airbag system failed		Have the system checked immediately.
	Active steering defective		You can continue your journey. Steering characteristics are modified and steering wheel could be off-center. Steer carefully. Have the system checked as soon as possible.
	Steering assistance failed		Markedly different steering response. You can continue your journey, but moderate your speed and exercise due caution. Have the system checked as soon as possible.
	Lights up: Emergency Request system has failed or is malfunctioning		Have the system checked as soon as possible.
	Lights up in red: Engine malfunction		Stop the car and switch off the engine. You cannot continue your journey. Contact your BMW center.
	Lights up in yellow: Full engine power is no longer available		You can continue your journey, but moderate your speed and exercise due caution. Have the engine checked as soon as possible.





1	2	Cause	What to do
SERVICE ENGINE SOON	Indication in US models: Warning lamp flashes: Engine malfunction under high load. High engine load will result in damage to the catalytic converter		You can continue your journey, but moderate your speed and exercise due caution. Have the vehicle checked without delay.
	Warning lamp comes on: Engine malfunction with adverse effect on emissions		Have the car checked as soon as possible.
	Indication in Canadian models: Warning lamp flashes: Engine malfunction under high load. High engine load will result in damage to the catalytic converter		You can continue your journey, but moderate your speed and exercise due caution. Have the vehicle checked without delay.
	Warning lamp comes on: Engine malfunction with adverse effect on emissions		Have the car checked as soon as possible.
	Lights up in red: Engine overheating		Carefully bring the car to a stop, switch off the engine and allow it to cool down. Do not open the hood; otherwise, there is a risk of injury from scalding. Contact your BMW center.
	Lights up in yellow: Engine too hot		Continue driving at more moderate speed so that the engine can cool down. Have the engine checked without delay if the situation reoccurs.
	Lights up in red: Battery is no longer being charged. Alternator malfunction		Switch off all unnecessary electrical consumers. Have the power supply system checked without delay.
	Lights up in yellow: Battery charge level very low, battery aged or not securely connected		Have the battery checked as soon as possible.
BRAKE	Indication in US models Parking brake applied		
	 Indication in Canadian models Parking brake applied		









1	2	Cause	What to do
BRAKE		Indication in US models Lights up in red: Brake fluid level too low Lights up in yellow: Drive-off assistant has failed. The car will not be held in place after the brake is released	Reduced braking effect, stop the car carefully. Contact your BMW center. Have the system checked as soon as possible.
		Indication in Canadian models Lights up in red: Brake fluid level too low Lights up in yellow: Drive-off assistant has failed. The car will not be held in place after the brake is released	Reduced braking effect, stop the car carefully. Contact your BMW center. Have the system checked as soon as possible.
BRAKE		Indication in US models Brake pads worn	Have the condition of the brake pads checked without delay.
		Indication in Canadian models Brake pads worn	Have the condition of the brake pads checked without delay.
		Lights up in red: <ul style="list-style-type: none">▷ Starter failed or▷ Ignition malfunctioning. Engine restart only possible when brake is depressed or▷ Lighting system failed. Low beams/ tail lamps and brake lamps still operational. All other lamps failed Lights up in yellow: <ul style="list-style-type: none">▷ Control of the brake lamps failed or▷ fuel supply malfunctioning	Have the system in question checked without delay. The engine cannot be restarted. Depress the brake to restart the engine.
		Flashing: Dynamic Stability Control DSC or Dynamic Traction Control DTC is controlling drive and braking forces, refer also to page 81	











1	2	Cause	What to do
DTC		Dynamic Traction Control DTC activated, refer also to page 81	
		Dynamic Stability Control DSC and Dynamic Traction Control DTC deactivated, refer also to page 81	Driving stability limited during acceleration and cornering. Driving style must be readjusted.
		Suspension control system failed, refer also to page 80	Driving stability limited during acceleration and cornering. You can continue your journey, but moderate your speed and exercise due caution. Have the system checked as soon as possible.
		xDrive has failed, refer also to page 82	You can continue your journey. Drive cautiously and think well ahead. Avoid driving on rough tracks, full-throttle operation and use of the transmission's kickdown mode. Have the system checked immediately.
		xDrive and DSC have failed, refer also to page 82	You can continue your journey. Drive cautiously and think well ahead. Avoid driving on rough tracks, full-throttle operation and use of the transmission's kickdown mode. Have the system checked immediately.
ABS BRAKE		Indication in US models The driving stability control systems, including ABS and the Tire Pressure Monitor, have failed, refer also to page 80	You can continue your journey. Reduced braking and driving stability. Drive at moderate speed, avoid sudden braking if possible. Have the system checked as soon as possible.
  		Indication* in Canadian models The driving stability control systems, including ABS and the Flat Tire Monitor or Tire Pressure Monitor*, have failed, refer also to page 80	You can continue your journey. Reduced braking and driving stability. Drive at moderate speed, avoid sudden braking if possible. Have the system checked as soon as possible.
  		Indication* in Canadian models The driving stability control systems, including ABS and the Flat Tire Monitor or Tire Pressure Monitor*, have failed, refer also to page 80	You can continue your journey. Reduced braking and driving stability. Drive at moderate speed, avoid sudden braking if possible. Have the system checked as soon as possible.

1	2	Cause	What to do
ABS BRAKE  		Indication in US models The driving stability control systems, including ABS, xDrive and the Flat Tire Monitor, have failed	You can continue your journey. Reduced braking and driving stability. Drive at moderate speed, avoid sudden braking if possible. Avoid driving on rough tracks, full-throttle operation and use of the transmission's kickdown mode. Have the system checked immediately.
   		Indication* in Canadian models The driving stability control systems, including ABS, xDrive and the Flat Tire Monitor, have failed	You can continue your journey. Reduced braking and driving stability. Drive at moderate speed, avoid sudden braking if possible. Avoid driving on rough tracks, full-throttle operation and use of the transmission's kickdown mode. Have the system checked immediately.
ABS   		Indication* in Canadian models The driving stability control systems, including ABS, xDrive and the Flat Tire Monitor, have failed	You can continue your journey. Reduced braking and driving stability. Drive at moderate speed, avoid sudden braking if possible. Avoid driving on rough tracks, full-throttle operation and use of the transmission's kickdown mode. Have the system checked immediately.
ABS BRAKE 		Indication in US models Vehicle electronics failed	You cannot continue your journey. Contact your BMW center.
  		Indication* in Canadian models Vehicle electronics failed	You cannot continue your journey. Contact your BMW center.
ABS  		Indication* in Canadian models Vehicle electronics failed	You cannot continue your journey. Contact your BMW center.

1	2	Cause	What to do
		<p>Vehicles with Flat Tire Monitor*</p> <p>Light up in yellow and red:</p> <ul style="list-style-type: none"> ▶ Tire is deflated ▶ Flat Tire Monitor not initialized <p>Light up in yellow: Flat Tire Monitor failed. Punctures are not indicated</p>	<p>Carefully bring the car to a stop. Comply with the additional information starting on page 83.</p> <p>Initialize Flat Tire Monitor, refer to page 83.</p> <p>Have the system checked.</p>
		<p>Vehicles with Tire Pressure Monitor*</p> <p>Light up in yellow and red:</p> <p>There is a flat tire or substantial loss of tire pressure</p>	<p>Carefully bring the car to a stop. Comply with the additional information starting on page 84.</p>
		<p>Vehicles with Tire Pressure Monitor*</p> <p>Light up in yellow:</p> <p>Tire Pressure Monitor not initialized</p> <p>The small lamp flashes in yellow and then lights up continuously; the larger lamp comes on in yellow:</p> <ul style="list-style-type: none"> ▶ Tire Pressure Monitor has failed. Punctures are not indicated ▶ A wheel without TPM electronics has been mounted ▶ Interference from systems or devices that use the same radio frequency. The system automatically reactivates once it is outside of the field of interference 	<p>Check the inflation pressure and reset the system, refer to page 85</p> <p>Have the system checked.</p> <p>Have the system checked.</p>

1	2	Cause	What to do
	Lights up in red:		
	▷	Transmission limp-home program active with restricted range of gears, possibly with reduced acceleration. Gears can be engaged without depressing the brake	You can continue your journey, but moderate your speed and exercise due caution. Have the system checked without delay. Always depress the brake to engage a gear.
	Lights up in yellow:		
	▷	Transmission limp-home program active with restricted range of gears	You can continue your journey, but moderate your speed and exercise due caution. Have the system checked without delay.
	▷	Automatic selector lever locked: Selector lever locked in position P with engine running or ignition switched on and brake depressed	Overriding selector lever lock, refer to page 55.
	▷	Transmission position P malfunctioning: Selector lever locked in position P with engine running or ignition switched on and brake depressed	Release parking lock, refer to page 58. Have the system checked as soon as possible.
	▷	Brake signal malfunctioning: gear can be engaged without depressing the brake	To engage a gear while the vehicle is at a standstill, always step on the brake. Before leaving the vehicle, engage P and switch off the engine.
<hr/>			
	Lights up in red:		
		Transmission overheating	Bring the car to a stop and engage P. Allow the transmission to cool down. You can continue your journey, but moderate your speed and exercise due caution. Have the system checked if the situation reoccurs.
	Lights up in yellow:		
	Transmission too hot		Avoid high engine loads. You can continue your journey, but moderate your speed and exercise due caution.
<hr/>			
	P is not engaged. Vehicle not prevented from rolling		
	Selector lever position P not engaged. Ignition cannot be switched off	Engage selector lever position P when you wish to switch off the ignition, refer to page 50.	

1	2	Cause	What to do
		Selector lever malfunctioning	You can continue your journey. Shift again if necessary. Have the system checked if the situation reoccurs.
		Brake signal malfunctioning: gear can be engaged without depressing the brake	To engage a gear while the vehicle is at a standstill, always step on the brake. Switch off the engine before leaving the vehicle. Have the system checked as soon as possible.
		Pinch protection system of the power windows malfunctioning	Have the system checked.
		Pinch protection system of the electric glass roof malfunctioning	Have the system checked.
		Cruise control deactivated:	
		<ul style="list-style-type: none"> ▷ Driving stability control systems are active or ▷ parking brake is applied or ▷ the vehicle has not achieved a speed of 20 mph or 30 km/h or ▷ engaged gear not suitable for the speed being driven 	
		Cruise control system failed	You can continue your journey. Have the system checked.
		Active cruise control deactivated:	Keep a safe distance.
		<ul style="list-style-type: none"> ▷ Driving stability control systems are active or ▷ parking brake is applied or ▷ the vehicle has not achieved a speed of 20 mph or 30 km/h or ▷ engaged gear not suitable for the speed being driven or ▷ Radar sensor dirty 	Clean the radar sensor, refer to page 68.
		Active cruise control failed	Keep a safe distance. Have the system checked.
		Park Distance Control failed	Have the system checked.

1	2	Cause	What to do
	<ul style="list-style-type: none"> ▷ High-beam assistant inactive ▷ High-beam assistant malfunctioning ▷ Sensitivity of the high-beam assistant has been changed 	<p>Clean the sensor field on the front of the interior rearview mirror, refer to page 94.</p> <p>Have the system checked by your nearest BMW center.</p> <p>There is a risk that oncoming traffic may be blinded. Have the system checked by your nearest BMW center.</p>	
	Bulb of exterior lighting system failed	Have the exterior lighting checked as soon as possible.	
	Low-beam headlamp or fog lamp failed	Have the low beams checked as soon as possible.	
	High-beam headlamp failed	Have the high-beam headlamps checked.	
	Adaptive light control failed		
	Coolant level too low	Add coolant immediately, refer to page 147 .	
	Engine oil pressure too low	Stop immediately and switch off the engine. You cannot continue your journey. Contact your BMW center.	
	Engine oil level too low	Add engine oil immediately; refer to page 145 for more information.	
	<p>Lights up in red:</p> <p>Service appointment overdue</p>	<p>Arrange a service appointment. Check service requirements, refer to page 76.</p>	
	<p>Lights up in yellow:</p> <p>Service due</p>	<p>Arrange a service appointment. Check service requirements, refer to page 76.</p>	
	No service due	Check service requirements, refer to page 76 .	
	Time and date no longer correct	Set the time and date, refer to page 77 .	



Reference

This chapter contains technical data and an index that will help you find information most quickly.

Technical data

Engine data

Coupe

		328i/xDrive	335i/xDrive	335is
Displacement	cu in/cm ³	182.8/2,996	181.8/2,979	181.8/2,979
Number of cylinders		6	6	6
Maximum power output	hp	230	300	335
at engine speed	rpm	6,500	5,800	5,900
Maximum torque	lb ft/Nm	200/270	300/407	332/450
at engine speed	rpm	2,750	1,400-5,000	1,500

Convertible

		328i	335i	335is
Displacement	cu in/cm ³	182.8/2,996	181.8/2,979	181.8/2,979
Number of cylinders		6	6	6
Maximum power output	hp	230	300	335
at engine speed	rpm	6,500	5,800	5,900
Maximum torque	lb ft/Nm	200/270	300/407	332/450
at engine speed	rpm	2,750	1,400-5,000	1,500

Dimensions

Coupe

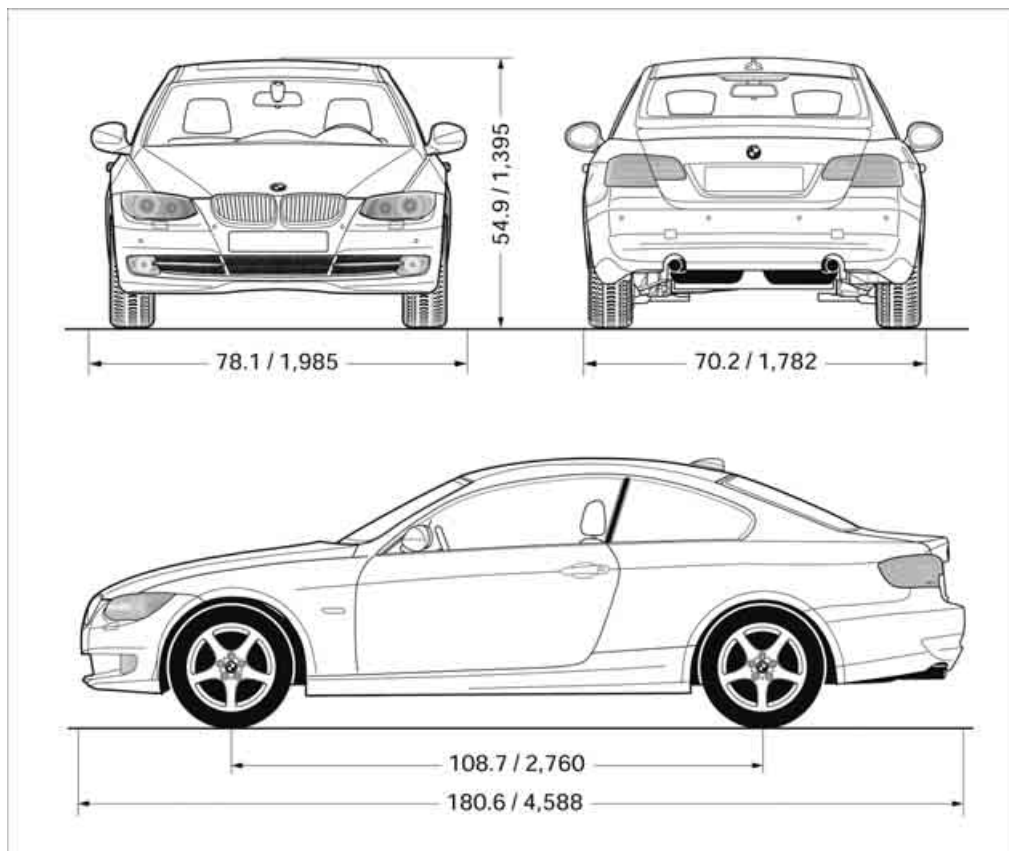

All dimensions given in inches/mm.

Smallest turning circle dia.: 36.1 ft/11.0 m, with xDrive: 38.7 ft/11.8 m.

335i, 335i xDrive, 335is: height approx. 54.1 in/1,375 mm

Convertible

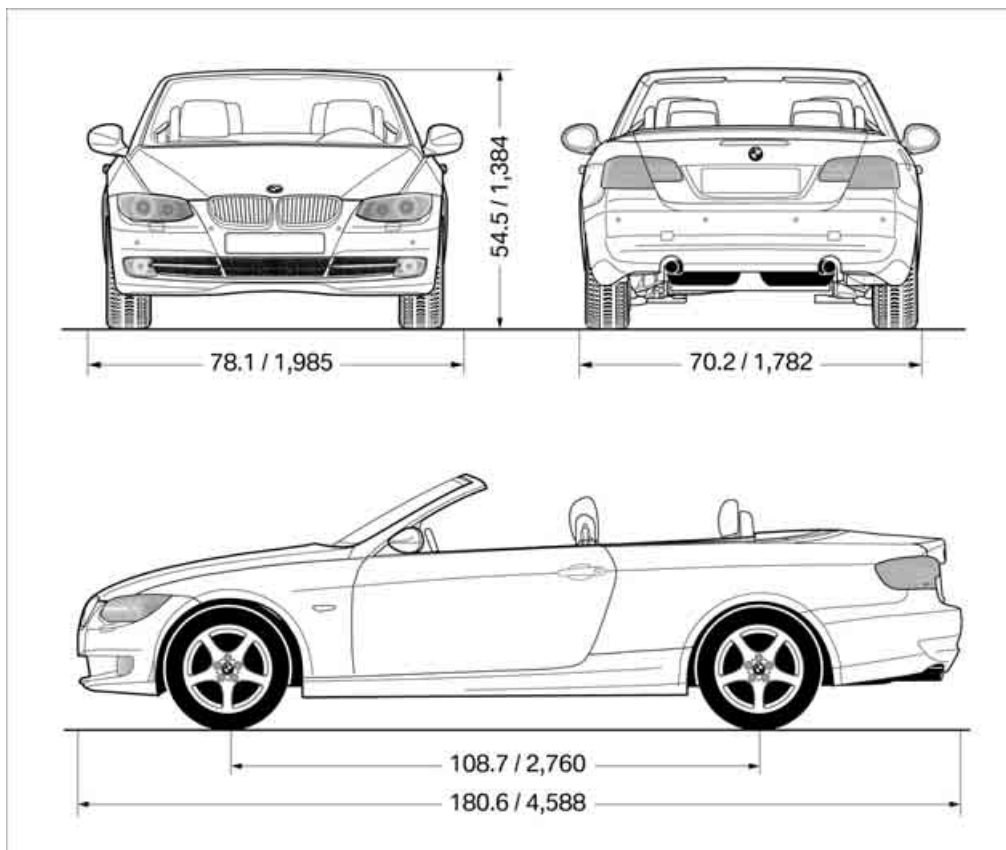

All dimensions given in inches/mm.
 Smallest turning circle dia.: 36.1 ft/11.0 m.
 335is height approx. 54.0 in/1,370 mm

Weights

Coupe

		328i	328i xDrive	335i	335i xDrive
Approved gross weight					
▷ with manual transmission	lbs/kg	4,288/1,945	4,508/2,045	4,486/2,035	4,663/2,115
▷ with automatic transmission	lbs/kg	4,354/1,975	4,552/2,065	4,508/2,045	4,685/2,125
Load	lbs/kg	882/400	882/400	882/400	882/400
Approved front axle load	lbs/kg	2,061/935	2,227/1,010	2,172/985	2,326/1,055
Approved rear axle load	lbs/kg	2,425/1,100	2,447/1,110	2,469/1,120	2,513/1,140
Approved roof load capacity	lbs/kg	165/75	165/75	165/75	165/75
Cargo area capacity	cu ft/ liters	15.5/440	15.5/440	15.2/430	15.2/430

335is

Approved gross weight					
▷ with manual transmission	lbs/kg				4,497/2,040
▷ Sports automatic transmission with double clutch	lbs/kg				4,519/2,050
Load	lbs/kg				882/400
Approved front axle load	lbs/kg				2,183/990
Approved rear axle load	lbs/kg				2,513/1,140
Approved roof load capacity	lbs/kg				165/75
Cargo area capacity	cu ft/ liters				15.2/430

Convertible

		328i	335i	335is
Approved gross weight				
▷ with manual transmission	lbs/kg	4,707/2,135	4,817/2,185	4,839/2,195
▷ with automatic transmission	lbs/kg	4,773/2,165	4,839/2,195	–
▷ Sports automatic transmission with double clutch	lbs/kg	–	–	4,872/2,210
Load	lbs/kg	838/380	838/380	838/380
Approved front axle load	lbs/kg	2,138/970	2,205/1,000	2,227/1,010
Approved rear axle load	lbs/kg	2,646/1,200	2,646/1,200	2,646/1,200
Approved roof load capacity	lbs/kg	–	–	–
Cargo area capacity	cu ft/ liters	7.4-12.4/ 210-350	7.4-12.4/ 210-350	7.4-12.4/ 210-350

Capacities

			Notes
Fuel tank	US gal/liters	approx. 16.1/61	Fuel grade: page 129
including reserve of	US gal/liters	approx. 2.1/8.0	
Window washer system			For more details: page 62
including headlamp washers	US qt/liters	approx. 6.3/6.0	

Everything from A to Z

Index

A

- ABS Antilock Brake System **80**
- ACC, refer to Active cruise control **64**
- Acceleration assistant, refer to Launch Control **59**
- Accident, refer to Sending an Emergency Request **159**
- Activated-charcoal filter for automatic climate control **103**
- Active Cruise Control
 - indicator lamp **67**
 - malfunction **68**
 - selecting distance **66**
 - sensor **68**
- Active cruise control **64**
- Active steering **87**
- Adaptive brake light
 - Brake Force Display **87**
- Adaptive light control **93**
- Additives
 - coolant **147**
- Adjusting temperature inside the car, refer to Air conditioner **98**
- Adjusting temperature inside the car, refer to Automatic climate control **100**
- Adjusting the thigh support **37**
- Airbags **88**
 - indicator/warning lamp **89**
 - sitting safely **36**
- Air conditioner **97**
- Air conditioning mode
 - air conditioner **98**
 - automatic climate control **100**
 - ventilation **99, 102**
- Air distribution
 - automatic **101**
 - individual **98**
 - manual **98**
- Airing, refer to Ventilation **99, 102**
- Air outlets, refer to Air vents **97**
- Air pressure, refer to Tire inflation pressure **130**
- Air recirculation, refer to Recirculated-air mode **98, 101**
- Air supply
 - air conditioner **98**
 - automatic climate control **100**
 - ventilation **99, 102**
- Air vents **97**
- Air volume **98, 101**
- AKI, refer to Fuel specifications **129**
- Alarm system **26**
 - avoiding unintentional alarms **27**
 - interior motion sensor **27**
 - switching off an alarm **26**
 - tilt alarm sensor **26**
- ALL program **102**
- All-season tires, refer to Winter tires **143**
- All-wheel drive, refer to xDrive **81**
- Ambient air, refer to Recirculated-air mode **98, 101**
- Antifreeze
 - coolant **147**
 - washer fluid **62**
- Antilock Brake System
 - ABS **80**
- Anti-theft alarm system, refer to Alarm system **26**
- Anti-theft system **19**
- Approved axle loads, refer to Weights **181**
- Approved gross vehicle weight, refer to Weights **181**
- Armrest, refer to Center armrest **108**
- Ashtray **110**
- Assist systems, refer to Driving stability control **80**
- AUC Automatic recirculated-air control **101**
- Audio device, external **108**
- Automatic
 - air distribution **101**
 - air volume **101**
 - cruise control **62, 64**
 - headlamp control **91**
- Automatic car washes **150**
- Automatic climate control **97**
- Automatic curb monitor **45**
- Automatic high beams and low beams, refer to High-beam assistant **94**
- Automatic recirculated-air control AUC **101**
- Automatic transmission with Steptronic **53**
 - interlock **53**
 - overriding selector lever lock **55**
 - shiftlock, refer to Changing selector lever position **53**
 - sport program **54**
 - towing **161**
 - tow-starting **161**
- AUTO program for automatic climate control **101**

AUX-IN
– port [108](#)
Average fuel consumption [73](#)
– setting the units [75](#)
Average speed [73](#)
Avoiding unintentional
alarms [27](#)
Axle loads, refer to
Weights [181](#)

B

Backrest contour, refer to
Lumbar support [38](#)
Backrests, refer to Seat
adjustment [37](#)
Backrest width adjustment [38](#)
Back seats
– refer to Rear seats [40](#)
Bag holder [112](#)
Band-aids, refer to First aid
pouch [160](#)
Bar, refer to Towing
methods [163](#)
Base plate for telephone or
mobile phone
– refer to Snap-in adapter in
the center armrest storage
compartment [108](#)
Battery [158](#)
– charging [158](#)
– disposal [29](#), [158](#)
– jump-starting [160](#)
– remote control [18](#)
– replacing [158](#)
– temporary power failure [158](#)
Battery renewal
– remote control [29](#)
– remote control for vehicle [29](#)
Being towed [162](#)
Belt hand-over [43](#)
– pinch protection system [44](#)
Belts, refer to Safety belts [43](#)
Belt tensioner, refer to Safety
belts [43](#)
Beverage holders, refer to
Cupholders [109](#)

Black ice, refer to Outside
temperature warning [71](#)
Blinds, refer to Roller sun
blinds [107](#)
Blower, refer to Air
volume [98](#), [101](#)
Bluetooth, refer to separate
Owner's Manual
BMW
– car shampoo [153](#)
BMW Homepage [4](#)
BMW Maintenance
System [148](#)
BMW webpage [4](#)
Bottle holders, refer to
Cupholders [109](#)
Brake Assist, refer to Dynamic
Brake Control DBC [80](#)
Brake fluid, refer to Service
requirements [76](#)
Brake Force Display [87](#)
Brake lamps
– Brake Force Display [87](#)
Brake pads [120](#)
– breaking in [120](#)
Brake rotors [123](#)
– brakes [120](#)
– breaking in [120](#)
Brakes
– ABS [80](#)
– BMW Maintenance
System [148](#)
– Brake Force Display [87](#)
– breaking in [120](#)
– parking brake [52](#)
– service requirements [76](#)
Brakes, refer to Braking
safely [122](#)
Brake system [120](#)
– BMW Maintenance
System [148](#)
– breaking in [120](#)
– disc brakes [123](#)
Breakdown services, refer to
Roadside Assistance [159](#)
Breaking in the clutch [120](#)
Breaking in the differential,
refer to Engine and
differential [120](#)

Break-in period [120](#)
Bulb changing, refer to Lamps
and bulbs [154](#)
Button for starting the engine,
refer to Start/stop button [50](#)
Buttons on the steering
wheel [11](#)

C

California Proposition 65
warning [6](#)
Calling, refer to Telephone
owner's manual
Can holders, refer to
Cupholders [109](#)
Capacities [182](#)
Capacity of the cargo area [181](#)
Car battery, refer to Vehicle
battery [158](#)
Car care, refer to Care [150](#)
Care [150](#)
– automatic car washes [150](#)
– care products [150](#)
– carpets [152](#)
– CD/DVD drives [153](#)
– chrome parts [152](#)
– displays [153](#)
– exterior [150](#)
– fine wood parts [153](#)
– headlamps [151](#)
– high-pressure washer [151](#)
– interior [152](#)
– leather [152](#)
– light-alloy wheels [152](#)
– paintwork [151](#)
– plastic parts [153](#)
– retractable hardtop [151](#)
– rubber seals [152](#)
– safety belts [153](#)
– sensors and cameras [153](#)
– upholstery and cloth
trim [152](#)
– washing the car
manually [151](#)
– windows [151](#)
Cargo, securing [124](#)

- Cargo area
 - capacity [181](#)
 - Comfort Access [28](#)
 - folding up the floor panel [113](#)
 - lamp, refer to Interior lamps [95](#)
 - opening from inside [24](#)
 - opening from outside [25](#)
- Cargo loading [123](#)
 - securing cargo [124](#)
 - stowing cargo [124](#)
 - vehicle [123](#)
- Car jack
 - jacking points [157](#)
- Car key, refer to Integrated key/remote control [18](#)
- Car phone
 - installation location, refer to Center armrest [108](#)
 - refer to separate Owner's Manual
- Car shampoo [153](#)
- Catalytic converter, refer to Hot exhaust system [121](#)
- Center armrest [108](#)
- Center brake lamp
 - replacing bulb [156](#)
- Center console, refer to Around the center console [14](#)
- Central locking
 - from inside [23](#)
 - from outside [19](#)
- Central locking system [19](#)
 - Comfort Access [27](#)
 - hotel function [25](#)
 - setting unlocking characteristics [20](#)
- Changes, technical, refer to For your own safety [5](#)
- Changing bulbs, refer to Lamps and bulbs [154](#)
- Changing gears [57](#)
- Changing wheels [157](#)
- Chassis number, refer to Engine compartment [145](#)
- Check Control [77](#)
- Child restraint fixing system LATCH [48](#)
- Child restraint systems [47](#)
- Child seats, refer to Transporting children safely [47](#)
- Chrome parts [153](#)
- Chrome polish [153](#)
- Cigarette lighter, refer to Lighter [110](#)
- Cleaning headlamps [61](#)
 - washer fluid [62](#)
- Cleaning your BMW, refer to Care [150](#)
- Climate control
 - automatic air distribution [101](#)
- Clock [71](#)
 - 12h/24h format [75](#)
 - setting time [77](#)
- Closing
 - from inside [23](#)
 - from outside [19](#)
- Clothes hooks [109](#)
- Cockpit [10](#)
- Cold start, refer to Starting the engine [51](#)
- Comfort Access [27](#)
 - replacing the battery [29](#)
- Comfort access, refer to Comfort Access [27](#)
- Comfort area, refer to Around the center console [14](#)
- Compartment for remote control, refer to Ignition lock [50](#)
- Compass [106](#)
- Computer [72](#)
- Condensation, refer to When the vehicle is parked [123](#)
- Condition Based Service CBS [148](#)
- Configuring settings, refer to Personal Profile [18](#)
- Confirmation signals for locking/unlocking the vehicle [21](#)
- Connecting vacuum cleaner, refer to Connecting electrical appliances [110](#)
- Consumption, refer to Average fuel consumption [73](#)
- Controls and displays [10](#)
- Convenient loading in Convertible [21](#)
- Convenient operation
 - glass roof [20](#)
 - glass roof with Comfort Access [28](#)
 - retractable hardtop [20](#)
 - windows [20](#)
 - windows with Comfort Access [28](#)
- Convertible
 - bag holder [112](#)
 - convenient loading [21](#)
 - enlarging cargo area [111](#)
 - folding down rear backrest [112](#)
 - retractable hardtop [32](#)
 - rollover protection system [90](#)
- Coolant [147](#)
 - checking level [147](#)
- Coolant temperature [72](#)
- Cooling, maximum [101](#)
- Cooling fluid, refer to Coolant [147](#)
- Cooling system, refer to Coolant [147](#)
- Copyright [2](#)
- Corner-illuminating lamps
 - replacing bulbs [155](#)
- Corner-illuminating lamps, refer to Adaptive light control [93](#)
- Cornering lamps, refer to Adaptive light control [93](#)
- Correct tires [142](#)
- Courtesy lamps, refer to Interior lamps [95](#)
- Cruise control [62](#)
 - active [64](#)
 - malfunction [64](#)

Cruise control, refer to Active cruise control **64**
Cruising range **73**
Cupholders **109**
Curb weight, refer to Weights **181**

D

Dashboard, refer to Cockpit **10**
Dashboard, refer to instrument cluster **12**
Dashboard lighting, refer to Instrument lighting **95**
Data, technical **178**
– capacities **182**
– dimensions **179**
– engine **178**
– weights **181**
Data memory **149**
Date
– setting **77**
Daytime running lights **92**
– replacing bulbs **155**
DBC Dynamic Brake Control **80**
Deactivating front passenger airbags **88**
Deadlocking, refer to Locking **20**
Defect
– door lock **23**
– fuel filler flap **128**
– glass roof **31**
Defogging windows **99**
Defrost, windows **99**
Defrosting windows and removing condensation
– air conditioner **99**
Defrosting windshield, refer to Defrosting windows **99**
Defrost position, refer to Defrosting windows **99**
Digital clock **71**
Digital compass **106**
Dimensions **179**
Directional indicators, refer to Turn signals **60**

Displacement, refer to Engine data **178**
Display lighting, refer to Instrument lighting **95**
Displays, refer to Instrument cluster **12**
Displays and controls **10**
Disposal
– coolant **147**
– remote control battery **29**
– vehicle battery **158**
Distance remaining to service, refer to Service requirements **76**
Distance warning, refer to Park Distance Control PDC **79**
Door key, refer to Remote control with integrated key **18**
Door lock **23**
Doors, emergency operation **23**
DOT Quality Grades **140**
Draft-free ventilation **99, 102**
Drinks holders, refer to Cupholders **109**
Drive mode **56**
Drive-off assistance, refer to Dynamic Stability Control DSC **80**
Drive-off assistant **82**
Driving dynamics control **58**
Driving lamps, refer to Parking lamps/low beams **91**
Driving notes **120**
Driving off on hills, refer to Drive-off assistant **82**
Driving stability control systems **80**
Driving through water **122**
Driving tips, refer to Driving notes **120**
Dry air, refer to Cooling function **102**
DSC Dynamic Stability Control **80**

DTC Dynamic Traction Control **81**
– indicator/warning lamp **81**
Dynamic Brake Control DBC **80**
Dynamic Stability Control DSC **80**
– indicator/warning lamp **81**
Dynamic Traction Control DTC
– indicator/warning lamp **81**

E

EBV Electronic brake-force distribution **80**
Electrical defect
– 7-gear Sports automatic transmission with double clutch **58**
Electrical malfunction
– door lock **23**
– driver's door **23**
– fuel filler flap **128**
– glass roof **31**
Electric seat adjustment **38**
Electric steering wheel lock
– with Comfort Access **28**
Electronic brake-force distribution EBV **80**
Electronic oil level check **145**
Electronic Stability Program ESP, refer to Dynamic Stability Control DSC **80**
Emergency actuation, automatic transmission, refer to Overriding selector lever lock **55**
Emergency operation
– fuel filler flap, manual release **128**
Emergency operation, refer to Closing manually
– glass roof **31**
Emergency operation, refer to Manual operation
– door lock **23**
Emergency release
– trunk lid from inside **25**

Emergency Request [159](#)
 Emergency services, refer to
 Roadside Assistance [159](#)
 Energy, saving
 – saving fuel [120](#)
 Engine
 – breaking in [120](#)
 – data [178](#)
 – overheated, refer to Coolant
 temperature [72](#)
 – speed [178](#)
 – starting [51](#)
 – starting, Comfort Access [27](#)
 – switching off [51](#)
 Engine compartment [145](#)
 Engine coolant, refer to
 Coolant [147](#)
 Engine oil
 – adding [146](#)
 – alternative oil types [147](#)
 – BMW Maintenance
 System [148](#)
 – capacity [182](#)
 – checking level [145](#)
 – intervals between changes,
 refer to Service
 requirements [76](#)
 Engine output, refer to Engine
 data [178](#)
 Engine speed, refer to Engine
 data [178](#)
 Engine starting, refer to
 Starting the engine [51](#)
 Entry lamps, refer to Interior
 lamps [95](#)
 Error messages, refer to
 Check Control [77](#)
 ESP Electronic Stability
 Program, refer to Dynamic
 Stability Control DSC [80](#)
 Exhaust system, refer to Hot
 exhaust system [121](#)
 Exterior mirrors [44](#)
 – adjusting [44](#)
 – automatic dimming
 feature [45](#)
 – automatic heating [44](#)
 – folding in and out [44](#)

External audio device [108](#)
 Eyes
 – for tow-starting and towing
 away [162](#)
 – for tying down loads [124](#)

F

Failure messages, refer to
 Check Control [77](#)
 Failure of an electrical
 consumer [158](#)
 False alarm
 – avoiding unintentional
 alarm [27](#)
 – switching off an alarm [26](#)
 Fastening safety belts, refer to
 Safety belts [43](#)
 Filter
 – refer to Microfilter/activated-
 charcoal filter for automatic
 climate control [103](#)
 – refer to Microfilter for air
 conditioner [99](#)
 First aid pouch [160](#)
 Fixture for remote control,
 refer to Ignition lock [50](#)
 Flash when locking/
 unlocking [21](#)
 Flat tire
 – run-flat tires [142](#)
 – Tire Pressure Monitor
 TPM [84](#)
 Flat Tire Monitor FTM [83](#)
 – indicating a flat tire [84](#)
 – indicator/warning lamp [84](#)
 – initializing the system [83](#)
 – snow chains [83](#), [143](#)
 – system limits [83](#)
 Flat tires, refer to Tire
 condition [141](#)
 Fluid reservoir, refer to
 Washer fluid reservoir [62](#)
 Fog lamps [95](#)
 – indicator lamp [95](#), [164](#)
 Folding up the floor panel [113](#)
 Footbrake, refer to Braking
 safely [122](#)

Footwell lamps, refer to
 Interior lamps [95](#)
 For your own safety [5](#)
 Four-wheel drive, refer to
 xDrive [81](#)
 Front airbags [88](#)
 FTM, refer to Flat Tire
 Monitor [83](#)
 Fuel [129](#)
 – average consumption [73](#)
 – gauge [72](#)
 – high-quality brands [129](#)
 – quality [129](#)
 – specifications [129](#)
 – tank contents, refer to
 Capacities [182](#)
 Fuel clock, refer to Fuel
 gauge [72](#)
 Fuel consumption indicator
 – average fuel
 consumption [73](#)
 Fuel display, refer to Fuel
 gauge [72](#)
 Fuel filler flap [128](#)
 – releasing in the event of
 electrical malfunction [128](#)
 Fuses [158](#)

G

Garage door opener, refer to
 Integrated universal remote
 control [104](#)
 Gasoline
 – refer to Average
 consumption [73](#)
 Gasoline, refer to Required
 fuel [129](#)
 Gasoline display, refer to Fuel
 gauge [72](#)
 Gear indicator, automatic
 transmission with
 Steptronic [53](#)
 Gear indicator, refer to
 Displays in the instrument
 cluster [55](#)

Gearshift lever [55](#)
– automatic transmission with Steptronic [53](#)
– manual transmission [52](#)
Gearshifts
– automatic transmission with Steptronic [53](#)
– manual transmission [52](#)
General driving notes [121](#)
Glass roof, electric [30](#)
– closing after electrical malfunction [31](#)
– convenient operation [20](#), [23](#)
– initializing [31](#)
– opening, closing [31](#)
– operation with Comfort Access [28](#)
– pinch protection system [31](#)
– power failure [31](#)
– raising [30](#)
– remote control [20](#)
Glove compartment [107](#)
Grills, refer to Air vents [97](#)
Gross vehicle weight, refer to Weights [181](#)

H

Handbrake, refer to Parking brake [52](#)
Hands-free system [14](#)
Hazard warning flashers [14](#)
HDC Hill Descent Control [82](#)
Head airbags [88](#)
Headlamp control, automatic [91](#)
Headlamp flasher [60](#)
– indicator lamp [11](#), [14](#), [164](#)
Head restraints [39](#)
– rear, removing [40](#)
– sitting safely [36](#)
Heated
– mirrors [44](#)
– rear window [99](#), [102](#)
– seats [41](#)
– steering wheel [46](#)

Heating [97](#)
– mirrors [44](#)
– rear window [99](#), [102](#)
– seats [41](#)
– steering wheel [46](#)
Heating and ventilation, refer to Climate [97](#)
Heavy loads, refer to Stowing cargo [124](#)
Height, refer to Dimensions [179](#)
Height adjustment
– seats [37](#)
– steering wheel [46](#)
High-beam assistant [94](#)
High beams [93](#)
– headlamp flasher [93](#)
– indicator lamp [164](#)
High beams and low beams, automatic, refer to High-beam assistant [94](#)
High-pressure washer [150](#), [151](#)
High water, refer to Driving through water [122](#)
Hill Descent Control HDC [82](#)
Hills [122](#)
Holders for cups [109](#)
Homepage BMW [4](#)
Hood [144](#)
Hooks for shopping bags [113](#)
Horn [10](#), [11](#)
Hotel function, refer to Locking or unlocking separately [25](#)
Hot exhaust system [121](#)
Hydraulic brake assist, refer to Dynamic Brake Control [80](#)
Hydroplaning [122](#)

I

Ice warning, refer to Outside temperature warning [71](#)
Identification marks
– run-flat tires [142](#)
– tire coding [140](#)

Ignition [50](#)
– switched off [51](#)
– switched on [50](#)
Ignition key, refer to Remote control with integrated key [18](#)
Ignition key position 1, refer to Radio readiness [50](#)
Ignition key position 2, refer to Ignition on [50](#)
Ignition lock [50](#)
Imprint [2](#)
Indicator and warning lamps [13](#)
– Tire Pressure Monitor TPM [85](#)
Indicator and warning lamps, overview [164](#)
Individual air distribution [98](#)
Inflation pressure, refer to Tire inflation pressure [130](#)
Inflation pressure monitoring, refer to Tire Pressure Monitor TPM [84](#)
Initializing
– after power failure [158](#)
– compass, refer to Calibrating [107](#)
– Flat Tire Monitor FTM [83](#)
– glass roof [31](#)
Installation location
– telephone [108](#)
Instrument cluster [12](#)
Instrument combination, refer to Instrument cluster [12](#)
Instrument lighting [95](#)
Instrument panel, refer to Cockpit [10](#)
Integrated key [18](#)
Integrated universal remote control [104](#)
Interior lamps [95](#)
– remote control [20](#)
Interior motion sensor [27](#)
Interior rearview mirror [45](#)
– automatic dimming feature [45](#)
– compass [106](#)

Interlock, refer to Disengaging the remote control [53](#)
 Intermittent mode of the wipers [61](#)

J

Jacking points [157](#)
 Jumpering, refer to Jump-starting [160](#)
 Jump-starting [160](#)

K

Key, refer to Integrated key/remote control [18](#)
 Keyless go, refer to Comfort Access [27](#)
 Keyless opening and closing, refer to Comfort Access [27](#)
 Key Memory, refer to Personal Profile [18](#)
 Kickdown [53](#)
 – automatic transmission with Steptronic [53](#)
 Knock control [129](#)

L

Lamps
 – automatic headlamp control [91](#)
 – parking lamps/low beams [91](#)
 Lamps and bulbs, replacing bulbs [154](#)
 Lap-and-shoulder belt, refer to Safety belts [43](#)
 Lashing eyes, refer to Securing cargo [124](#)
 LATCH child restraint fixing system [48](#)
 Launch Control [59](#)
 Leather care [152](#)
 LED Light-emitting diodes [154](#)
 Length, refer to Dimensions [179](#)
 License plate lamp, replacing bulb [156](#)
 Light
 – high-beam assistant [94](#)
 Light-alloy wheels [152](#)
 Light-emitting diodes LED [154](#)
 Lighter [110](#)
 – connecting electrical appliances [110](#)
 Lighting
 – instruments [95](#)
 – lamps and bulbs [154](#)
 – vehicle, refer to Lamps [91](#)
 Light switch [91](#)
 Load [124](#)
 Load securing equipment, refer to Securing cargo [124](#)
 Lock buttons, doors, refer to Locking [24](#)
 Locking
 – adjusting confirmation signal [21](#)
 – from inside [24](#)
 – from outside [20](#)
 – without remote control, refer to Comfort Access [27](#)
 Locking and unlocking doors
 – confirmation signals [21](#)
 – from inside [23](#)
 – from outside [19](#)
 Low beam control, refer to High-beam assistant [94](#)
 Low-beam headlamps [91](#)
 – automatic [91](#)
 – indicator lamp, defective bulb [174](#)
 Lower back support, refer to Lumbar support [38](#)
 Luggage rack, refer to Roof-mounted luggage rack [125](#)
 Lumbar support [38](#)

M

M+S tires, refer to Winter tires [143](#)
 Maintenance, refer to Service Booklet
 Maintenance system [148](#)
 Malfunction
 – automatic transmission with Steptronic [55](#)
 – tires [84](#)
 Malfunction warnings, refer to Check Control [77](#)
 Manual air distribution [98](#)
 Manual car wash [151](#)
 Manually unlocking parking lock [58](#)
 Manual mode, automatic transmission with Steptronic [54](#)
 Manual operation
 – door lock [23](#)
 – driver's door [23](#)
 – fuel filler flap [128](#)
 – glass roof [31](#)
 – parking lock [58](#)
 – parking lock, automatic transmission [55](#)
 Manual transmission [52](#)
 Master key, refer to Remote control with integrated key [18](#)
 Maximum cooling [101](#)
 Maximum speed
 – with winter tires [143](#)
 Measurements, refer to Dimensions [179](#)
 Memory, refer to Seat and mirror memory [41](#)
 Microfilter
 – BMW Maintenance System [148](#)
 – for air conditioner [99](#)
 – for automatic climate control [103](#)

Microfilter/activated-charcoal filter
– BMW Maintenance System [148](#)
Microphone
– telephone [14](#)
Mirror dimming feature [45](#)
Mirrors [44](#)
– automatic curb monitor [45](#)
– exterior mirrors [44](#)
– heating [44](#)
– interior rearview mirror [45](#)
– memory, refer to Seat and mirror memory [41](#)
Mirrors, folding in before entering a car wash [44](#)
Mobile phone
– installation location, refer to Center armrest [108](#)
– refer to separate Owner's Manual
Mobile phone, installation location, refer to Center armrest [108](#)
Mobile phone, refer to the separate Owner's Manual
Modifications, technical, refer to For your own safety [5](#)
Monitoring system for tire pressures, refer to Flat Tire Monitor [83](#)
Multifunctional steering wheel, refer to Buttons on the steering wheel [11](#)
Multifunction switch
– refer to Turn signals/headlamp flasher [60](#)
– refer to Wiper system [61](#)

N

Neck support, refer to Head restraints [39](#)
Nets, refer to Storage compartments [108](#)
Neutral [56](#)

New tires [142](#)
Next Service indicator, refer to Condition Based Service CBS [148](#)
Number of cylinders, refer to Engine data [178](#)
Nylon rope, refer to Tow rope [163](#)

O

OBD socket, refer to Socket for Onboard Diagnosis [149](#)
Octane ratings, refer to Fuel specifications [129](#)
Odometer [71](#)
Oil, refer to Engine oil [145](#)
Oil consumption [145](#)
Oil level [145](#)
Old batteries, refer to Disposal [158](#)
Onboard vehicle tool kit [154](#)
Opening and closing
– Comfort Access [27](#)
– from inside [23](#)
– from outside [19](#)
– using the door lock [23](#)
– using the remote control [19](#)
Outlets
– refer to Ventilation [99](#), [102](#)
Outlets, refer to Air vents [97](#)
Output, refer to Engine data [178](#)
Outside-air mode
– automatic climate control [101](#)
Outside temperature display [71](#)
– changing unit of measure [75](#)
– in computer [75](#)
Outside temperature warning [71](#)
Overheated engine, refer to Coolant temperature [72](#)
Overriding selector lever lock [55](#)

P

Paintwork care [151](#)
Park assistant, refer to Park Distance Control [79](#)
Park Distance Control PDC [79](#)
Parking
– vehicle [51](#)
Parking aid, refer to Park Distance Control PDC [79](#)
Parking brake [52](#)
– indicator lamp [52](#)
Parking lamps [91](#)
– replacing bulbs [155](#)
Parking lamps/low beams [91](#)
Passenger side mirror tilt function [45](#)
Pathway lighting [91](#)
Personal Profile [18](#)
Pinch protection system
– glass roof, electric [31](#)
– windows [30](#)
Polish [153](#)
Pollen
– refer to Microfilter/activated-charcoal filter for automatic climate control [103](#)
– refer to Microfilter for air conditioner [99](#)
Power failure [158](#)
Power windows [29](#)
Power windows, refer to Windows [29](#)
Pressure, tires [130](#)
Pressure monitoring, tires [83](#)
– Flat Tire Monitor [83](#)
Pressure monitoring of tires, refer to Tire Pressure Monitor TPM [84](#)
Programmable buttons on the steering wheel [11](#)
Protection function, refer to Pinch protection system
– glass roof, electric [31](#)
– windows [30](#)

Providing medical assistance, refer to First aid pouch [160](#)
 Puncture
 – Flat Tire Monitor [83](#)

R

Radio
 – refer to separate Owner's Manual
 Radio position, refer to Radio readiness [50](#)
 Radio readiness [50](#)
 – switched off [51](#)
 – switched on [50](#)
 Radio-remote key, refer to Remote control with integrated key [18](#)
 Rain sensor [61](#)
 Reading lamps [96](#)
 Rear lamps, refer to Tail lamps [156](#)
 Rear seats
 – adjusting head restraints [40](#)
 – folding down backrests [111](#)
 Rear ventilation [103](#)
 Rearview mirror, refer to Mirrors [44](#)
 Rear window defroster [99](#), [102](#)
 Rear window roller blind, refer to Roller sun blinds [107](#)
 Recirculated-air mode [98](#), [101](#)
 Recirculation of air, refer to Recirculated-air mode [98](#), [101](#)
 Reclining seat, refer to Backrest [37](#)
 Refueling [128](#)
 Releasing
 – hood [144](#)
 Remaining distance, refer to Cruising range [73](#)

Remote control [18](#)
 – battery renewal [29](#)
 – Comfort Access [27](#)
 – garage door opener [104](#)
 – malfunction [22](#), [28](#)
 – removing from the ignition lock [50](#)
 – service data [148](#)
 – trunk lid [21](#)
 Replacement fuses, refer to Fuses [158](#)
 Replacement remote control [18](#)
 Replacing bulbs, refer to Lamps and bulbs [154](#)
 Replacing tires [142](#)
 Replacing tires, refer to New wheels and tires [142](#)
 Reporting safety defects [6](#)
 Reserve warning, refer to Fuel gauge [72](#)
 Restraint systems
 – for children [47](#)
 – refer to Safety belts [43](#)
 Retractable hardtop [32](#)
 – care, refer to Caring for your vehicle brochure
 – convenient operation [20](#)
 – opening and closing [33](#)
 – remote control [20](#)
 Reverse gear [56](#)
 – automatic transmission with Steptronic [53](#)
 – manual transmission [53](#)
 Roadside Assistance [159](#)
 Roadside parking lamps [93](#)
 – replacing bulbs [155](#)
 Roadworthiness test, refer to Service requirements [76](#)
 Roller sun blinds [107](#)
 Rollover protection system, Convertible [90](#)
 – resetting [90](#)

Roof load capacity [181](#)
 Roof-mounted luggage rack [125](#)
 Rope, refer to Tow-starting, towing away [163](#)
 RSC Runflat System
 Component, refer to Run-flat tires [142](#)
 Runflat System Component RSC, refer to Run-flat tires [142](#)
 Run-flat tires [142](#)
 – continuing driving with a damaged tire [84](#)
 – flat tire [84](#)
 – Flat Tire Monitor [84](#)
 – Inflation pressure [130](#)
 – new tires [142](#)
 – tire replacement [142](#)
 – winter tires [143](#)
 Runflat tyres, refer to Run-flat tires [142](#)

S

Safety-belt height adjustment [43](#)
 Safety belts [43](#)
 – belt hand-over [43](#)
 – damage [43](#)
 – indicator/warning lamp [43](#)
 – reminder [43](#)
 – sitting safely [36](#)
 Safety systems
 – airbags [88](#)
 – Antilock Brake System ABS [80](#)
 – brake system [80](#)
 – driving stability control [80](#)
 – Dynamic Stability Control DSC [80](#)
 – rollover protection system, Convertible [90](#)
 – safety belts [43](#)

- Safety tires, refer to Run-flat tires [142](#)
- Saving fuel [120](#)
- Screw thread for tow fitting [162](#)
- Seat adjustment
 - electric [38](#)
 - mechanical [37](#)
- Seat and mirror memory [41](#)
- Seat belt reminder, refer to "Fasten safety belts" reminder [43](#)
- Seat heating [41](#)
- Seats [37](#)
 - adjusting electrically [38](#)
 - adjusting the seats [37](#)
 - heating [41](#)
 - memory, refer to Seat and mirror memory [41](#)
 - saving a setting, refer to Seat and mirror memory [41](#)
 - sitting safely [36](#)
- Securing cargo [114](#), [115](#)
- Securing the vehicle
 - from inside [23](#)
 - from outside [19](#)
- Selecting distance for active cruise control [66](#)
- Selector lever
 - automatic transmission with Steptronic [53](#)
- Selector lever lock, refer to Changing selector lever positions, shiftlock [53](#)
- Selector lever positions [55](#)
 - automatic transmission with Steptronic [53](#)
- Service, refer to Roadside Assistance [159](#)
- Service car, refer to Roadside Assistance [159](#)
- Service data in the remote control [148](#)
- Service Interval Display, refer to Condition Based Service CBS [148](#)
- Service requirements [76](#)
- Settings
 - clock, 12h/24h format [75](#)
- Settings and information [74](#)
- Shifting [57](#)
 - 7-gear Sports automatic transmission with double clutch [57](#)
- Shifting gears
 - automatic transmission with Steptronic [54](#)
 - manual transmission [52](#)
- Shift into a drive position, refer to selector lever positions [55](#)
- Shiftlock
 - automatic transmission, refer to Changing selector lever positions [53](#)
- Shift paddles on the steering wheel [57](#)
- Side airbags [88](#)
- Side windows, refer to Windows [29](#)
- Signal horn, refer to Horn [10](#), [11](#)
- Sitting safely [36](#)
 - with airbags [36](#)
 - with head restraint [36](#)
 - with safety belts [36](#)
- Ski bag [113](#)
- Ski bag for Convertible, refer to Through-loading opening with integrated transport bag [114](#)
- Sliding/tilt sunroof, refer to Glass roof, electric [30](#)
- Slot for remote control [50](#)
- Smokers' package, refer to Ashtray [110](#)
- Snap-in adapter, refer to Center armrest storage compartment [108](#)
- Socket, Onboard Diagnosis OBD [149](#)
- Socket, refer to Connecting electrical appliances [110](#)
- SOS, refer to Sending an Emergency Request [159](#)
- Spare fuses [158](#)
- Speed
 - Run-flat tires [84](#)
 - with winter tires [143](#)
- Speedometer [12](#)
- Speed reading, refer to Speedometer [12](#)
- Sport program with 7-gear Sports automatic transmission with double clutch [57](#)
- Sports automatic transmission with double clutch [55](#)
 - driving dynamics control [58](#)
 - Kick-down [56](#)
 - Launch Control [59](#)
 - manually unlocking parking lock [58](#)
 - neutral [56](#)
 - reverse gear [56](#)
- Spray nozzles, refer to Cleaning windshield and headlamps [61](#)
- Stability control, refer to Driving stability control systems [80](#)
- Start/stop button [50](#)
 - starting the engine [51](#)
 - switching off the engine [51](#)
- Starting, refer to Starting the engine [51](#)
- Starting assistance, refer to Jump-starting [160](#)
- Starting difficulties
 - jump-starting [160](#)
- Starting the engine
 - start/stop button [50](#)
- Status of this Owner's Manual at time of printing [5](#)
- Steam jet [150](#), [151](#)

Steering wheel [46](#)
– adjustment [46](#)
– buttons on steering wheel [11](#)
– heating [46](#)
– lock [50](#)
– locking with Comfort Access [28](#)
– shift paddles [57](#)
Steering wheel buttons, refer to Shift paddles [57](#)
Steering with variable ratio, refer to Active steering [87](#)
Steptronic, refer to Automatic transmission with Steptronic [53](#)
Storage [153](#)
Storage compartments [108](#)
Storage nets [113](#)
Storing seat positions, refer to Seat and mirror memory [41](#)
Storing tires [143](#)
Stowage, refer to Storage compartments [108](#)
Summer tires, refer to Wheels and tires [130](#)
Switches, refer to Cockpit [10](#)
Switching off
– engine [51](#)
Switching off the engine
– start/stop button [50](#)
Switching the cooling function on and off [102](#)
Symbols [4](#)

T

Tachometer [71](#)
Tailgate, refer to Trunk lid [24](#)
Tail lamp
– replacing bulb [156](#)
Tail lamp, refer to Tail lamps [156](#)
Tail lamps [156](#)
– replacing bulb [156](#), [157](#)
Tank contents, refer to Capacities [182](#)
Technical data [178](#)
– dimensions [179](#)
Technical modifications, refer to For your own safety [5](#)
Telephone
– installation location, refer to Center armrest [108](#)
– refer to separate Owner's Manual
Temperature
– air conditioner [99](#)
– automatic climate control [100](#)
– coolant, refer to Coolant temperature [72](#)
Temperature display
– outside temperature [71](#)
– outside temperature warning [71](#)
– setting the units [75](#)
Tempomat, refer to Cruise control [62](#)
Tensioning straps, refer to Securing cargo [124](#)
The individual vehicle [5](#)
Third brake lamp, refer to Center brake lamp [156](#)
Through-loading opening with integrated transport bag [114](#)
Through-loading system [111](#)
Tilt alarm sensor [26](#)
Tilt function, passenger side mirror [45](#)
Tire inflation pressure [130](#)
– loss [84](#)
Tire pressure monitoring, refer to Flat Tire Monitor [83](#)
Tire Pressure Monitor TPM [84](#)
– resetting the system [85](#)
– system limitations [84](#)
– warning lamp [85](#)
Tire puncture, refer to Flat Tire Monitor [84](#)
Tire Quality Grading [140](#)
Tires
– age [140](#), [142](#)
– air loss [85](#)
– breaking in [120](#)
– changing, refer to Changing wheels [157](#)
– condition [141](#)
– damage [141](#)
– inflation pressure [130](#)
– labels [140](#)
– minimum tread depth [141](#)
– new wheels and tires [142](#)
– pressure monitoring, refer to Flat Tire Monitor [83](#)
– pressure monitoring, refer to Tire Pressure Monitor TPM [84](#)
– puncture [84](#)
– replacing [142](#)
– size [140](#)
– storage [143](#)
– tread depth [141](#)
– wear indicators, refer to Minimum tread depth [141](#)
– wheel/tire combination, refer to Correct wheels and tires [142](#)
– winter tires [143](#)
Tools, refer to Onboard vehicle tool kit [154](#)
Top, refer to Retractable hardtop [32](#)
Torque, refer to Engine data [178](#)
Tow bar [163](#)
Tow fitting [162](#)
– screw thread [162](#)
Tow fittings for tow-starting and towing away [162](#)
Towing [161](#)
– car with automatic transmission [161](#)
– methods [163](#)
– with 7-gear Sports automatic transmission with double clutch [162](#)

Towing and tow-starting 161
Tow rope 163
Tow-starting 161, 163
TPM, refer to Tire Pressure Monitor 84
Traction control, refer to
 Dynamic Stability Control DSC 80
Transmission
– 7-gear Sports automatic transmission with double clutch 55
– automatic transmission with Steptronic 53
– idle position 56
– Launch Control 59
– manually unlocking parking lock 58
– manual transmission 52
– overriding selector lever lock for automatic transmission with Steptronic 55
– reverse gear 56
Transmission interlock
– refer to Changing selector lever position 53
– refer to P Park 53
Transporting children safely 47
Transport securing devices, refer to Securing cargo 124
Tread depth, refer to Minimum tire tread 141
Trip-distance counter, refer to Trip odometer 71
Triple turn signal activation 60
Trip odometer 71
Trunk lid 24
– Comfort Access 28
– emergency release 25
– locking or unlocking separately 25
– opening from inside 24
– opening from outside 25
– remote control 21
Turning circle, refer to Dimensions 179

Turn signal indicators
– indicator/warning lamp 12
Turn signals 60
– triple turn signal 60
Tying down loads, refer to Cargo loading 124

U

Uniform Tire Quality Grading/UTQR 140
Units
– average fuel consumption 75
Units of measure
– temperature 75
Universal garage door opener, refer to Integrated universal remote control 104
Universal mobile phone preparation package, refer to separate Owner's Manual
Unlatching, refer to Unlocking 27
Unlocking
– from inside 24
– from outside 19
– setting unlocking characteristics 20
– trunk lid 28
– without remote control, refer to Comfort Access 27

V

Vehicle
– battery 158
– breaking in 120
– cargo loading 123
– Identification Number, refer to Engine compartment 145
– measurements, refer to Dimensions 179
– parking 51
– weight 181
Vehicle jack 157
Vehicle storage 153

Ventilation 102
– air conditioner 99
– draft-free 99, 102
– in the rear 103
Ventilation, refer to Climate 97
Vents, refer to Air vents 97
Vents, refer to Ventilation 99, 102
Volume
– fuel tank, refer to Capacities 182

W

Warning and indicator lamps 13
Warning and indicator lamps, overview 164
Warning messages, refer to Check Control 77
Warning triangle 160
Washer fluid 62
– content of the reservoir 62
Washer fluid reservoir 62
Waste tray, refer to Ashtray 110
Water on roads, refer to Driving through water 122
Water penetration 150, 151
Wear indicators in tires, refer to Minimum tread depth 141
Weights 181
Welcome lamps 91
Wheel/tire combination, refer to Correct wheels and tires 142
Wheelbase, refer to Dimensions 179
Wheels, new 142
Wheels and tires 130
Width, refer to Dimensions 179
Wind deflector 33
Windows 29
– convenient operation 20
– convenient operation with Comfort Access 28
– opening, closing 29
– pinch protection system 30

- Windows, defrosting [99](#)
- Windshield
 - cleaning [61](#)
 - defrosting and removing condensation [99](#)
- Windshield wash [61](#)
 - filling capacity, reservoir [182](#)
 - nozzles [62](#)
 - reservoir for washer fluid [62](#)
 - washer fluid [62](#)
- Windshield wiper blades, changing [154](#)
- Windshield wipers, refer to Wiper system [61](#)
- Winter tires [143](#)
 - storage [143](#)
- Wiper blade replacement [154](#)
- Wiper system [61](#)
- Work in the engine compartment [144](#)
- Wrench/screwdriver, refer to Onboard vehicle tool kit [154](#)

X

- xDrive [81](#)
- Xenon lamps
 - replacing bulb [155](#)

Y

- Your individual vehicle
 - settings, refer to Personal Profile [18](#)

More about BMW

bmwusa.com



The Ultimate
Driving Machine

01 41 2 604 304 Ue Basis

