

Owner's Manual for  
Vehicle



The Ultimate Driving  
Machine

# Contents

## A-Z





**535i**  
**550i**  
**535i xDrive**  
**550i xDrive**

## **Owner's Manual for Vehicle**

Thank you for choosing a BMW.

The more familiar you are with your vehicle, the better control you will have on the road. We therefore strongly suggest:

Read this Owner's Manual before starting off in your new BMW. Also use the Integrated Owner's Manual in your vehicle. It contains important information on vehicle operation that will help you make full use of the technical features available in your BMW. The manual also contains information designed to enhance operating reliability and road safety, and to contribute to maintaining the value of your BMW.

Any updates made after the editorial deadline for the printed or integrated Owner's Manual are located in the appendix of the printed quick reference for the vehicle.

Supplementary information can be found in the additional brochures in the onboard literature.

We wish you a safe and enjoyable drive.

BMW AG

© 2011 Bayerische Motoren Werke  
Aktiengesellschaft  
Munich, Germany  
Reprinting, including excerpts, only with the written  
consent of BMW AG, Munich.  
US English II/11, 03 11 490  
Printed on environmentally friendly paper, bleached  
without chlorine, suitable for recycling.



# Contents

The fastest way to find information on a particular topic or item is by using the index, refer to page 286.

## Using this Owner's Manual

6 Notes

## At a glance

12 Cockpit  
19 iDrive  
25 Voice activation system  
27 Integrated Owner's Manual in the vehicle

## Controls

32 Opening and closing  
49 Adjusting  
62 Transporting children safely  
66 Driving  
76 Displays  
85 Lamps  
89 Safety  
99 Driving stability control systems  
106 Driving comfort  
127 Climate control  
133 Interior equipment  
139 Storage compartments

## Driving tips

146 Things to remember when driving

## Navigation

154 Navigation

## Entertainment

172 Tone  
174 Radio  
181 CD/multimedia  
201 Rear entertainment

## Communication

210 Telephone  
221 Office  
230 Contacts  
232 BMW ConnectedDrive

## Mobility

240 Refueling  
242 Fuel  
243 Wheels and tires  
251 Engine compartment  
253 Engine oil  
256 Maintenance  
258 Replacing components  
264 Breakdown assistance  
269 Care

## Reference

274 Technical data  
277 Short commands of the voice activation system  
286 Everything from A to Z

# Notes

## Using this Owner's Manual

The fastest way to find information on a particular topic is by using the index.

An initial overview of the vehicle is provided in the first chapter.

### Updates made after the editorial deadline

Any updates made after the editorial deadline for the Owner's Manuals are located in the appendix of the printed quick reference for the vehicle.

### Additional sources of information

Should you have any questions, your service center will be glad to advise you at any time.

Information on BMW, e.g., on technology, is available on the Internet: [bmwusa.com](http://bmwusa.com).

## Symbols

 Indicates precautions that must be followed precisely in order to avoid the possibility of personal injury and serious damage to the vehicle.

◀ Marks the end of a specific item of information.

\* Indicates special equipment, country-specific equipment and optional accessories, as well as equipment and functions not yet available at the time of printing.

"..." Identifies Control Display texts used to select individual functions.

›...‹ Verbal instructions to use with the voice activation system.

»...« Identifies the answers generated by the voice activation system.

 Refers to measures that can be taken to help protect the environment.

## Symbols on vehicle components

 Indicates that you should consult the relevant section of this Owner's Manual for information on a particular part or assembly.

## Your individual vehicle

You have decided in favor of a vehicle with individualized equipment and features.

This Owner's Manual describes the entire array of options and equipment available for a specific model.

As a result, the manual may contain accessories and equipment that you may not have specified for your own vehicle.

All options and special equipment are marked with an asterisk \*.

For options and equipment not described in this Owner's Manual, please refer to the Supplementary Owner's Manuals.

On right-hand drive vehicles, some controls are arranged differently than shown in the illustrations.

## Status of the Owner's Manual

The manufacturer of your vehicle pursues a policy of constant development that is conceived to ensure that our vehicles continue to embody the highest quality and safety standards. In rare cases, therefore, the features described in this Owner's Manual may differ from those in your vehicle.

### Updates made after the editorial deadline

Any updates made after the editorial deadline for the Owner's Manuals are located in the appendix of the printed quick reference for the vehicle.

## For your own safety

### Maintenance and repairs

Advanced technology, e.g., the use of modern materials and high-performance electronics, requires suitable maintenance and repair methods.

Therefore, have this work performed only by a BMW center or a workshop that works according to BMW repair procedures with appropriately trained personnel.

If this work is not carried out properly, there is the danger of subsequent damage and related safety hazards.

### Parts and Accessories

For your own safety, use genuine parts and accessories approved by BMW. When you purchase accessories tested and approved by BMW and Genuine BMW Parts, you simultaneously acquire the assurance that they have been thoroughly tested by BMW to ensure optimum performance when installed on your vehicle. BMW warrants these parts to be free from defects in material and workmanship. BMW will not accept any liability for damage resulting from installation of parts and accessories not approved by BMW. BMW cannot test every product made by other manufacturers to verify if it can be used on a BMW safely and without risk to either the vehicle, its operation, or its occupants. Genuine BMW Parts, BMW Accessories and other products approved by BMW, together with professional advice on using these items, are available from all BMW centers. Installation and operation of non-BMW approved accessories such as alarms, radios, amplifiers, radar detectors, wheels, suspension components, brake dust shields, telephones, including operation of any mobile phone from within the vehicle without using an externally mounted antenna, or transceiver equipment, for instance, CBs, walkie-talkies, ham radios or similar accessories, may cause extensive damage to the vehicle, compromise its safety, interfere with the vehicle's electrical system or affect the validity of the BMW Limited Warranty. See your BMW center

for additional information. Maintenance, replacement, or repair of the emission control devices and systems may be performed by any automotive repair establishment or individual using any certified automotive part.

### California Proposition 65 Warning

California laws require us to state the following warning:

Engine exhaust and a wide variety of automobile components and parts, including components found in the interior furnishings in a vehicle, contain or emit chemicals known to the State of California to cause cancer and birth defects and reproductive harm. In addition, certain fluids contained in vehicles and certain products of component wear contain or emit chemicals known to the State of California to cause cancer and birth defects or other reproductive harm. Battery posts, terminals and related accessories contain lead and lead compounds. Wash your hands after handling. Used engine oil contains chemicals that have caused cancer in laboratory animals. Always protect your skin by washing thoroughly with soap and water.

### Service and warranty

We recommend that you read this publication thoroughly. Your vehicle is covered by the following warranties:

- ▶ New Vehicle Limited Warranty.
- ▶ Rust Perforation Limited Warranty.
- ▶ Federal Emissions System Defect Warranty.
- ▶ Federal Emissions Performance Warranty.
- ▶ California Emission Control System Limited Warranty.

Detailed information about these warranties is listed in the Service and Warranty Information Booklet for US models or in the Warranty and Service Guide Booklet for Canadian models.

Your vehicle has been specifically adapted and designed to meet the particular operating conditions and homologation requirements in your country and continental region in order to deliver the full driving pleasure while the vehicle is operated under those conditions. If you wish to op-

erate your vehicle in another country or region, you may be required to adapt your vehicle to meet different prevailing operating conditions and homologation requirements. You should also be aware of any applicable warranty limitations or exclusions for such country or region. In such case, please contact Customer Relations for further information.

## Reporting safety defects

### For US customers

The following only applies to vehicles owned and operated in the US.

If you believe that your vehicle has a defect which could cause a crash or could cause injury or death, you should immediately inform the National Highway Traffic Safety Administration NHTSA, in addition to notifying BMW of North America, LLC, P.O. Box 1227, Westwood, New Jersey 07675-1227, Telephone 1-800-831-1117.

If NHTSA receives similar complaints, it may open an investigation, and if it finds that a safety defect exists in a group of vehicles, it may order a recall and remedy campaign.

However, NHTSA cannot become involved in individual problems between you, your dealer, or BMW of North America, LLC.

To contact NHTSA, you may call the Vehicle Safety Hotline toll-free at 1-888-327-4236 (TTY: 1-800-424-9153); go to <http://www.safercar.gov>; or write to: Administrator, NHTSA, 400 Seventh Street, SW., Washington, DC 20590. You can also obtain other information about motor vehicle safety from <http://www.safercar.gov>

### For Canadian customers

Canadian customers who wish to report a safety-related defect to Transport Canada, Defect Investigations and Recalls, may telephone the toll-free hotline 1-800-333-0510. You can also obtain other information about motor vehicle safety from <http://www.tc.gc.ca/roadsafety>.





## At a glance

These overviews of buttons, switches and displays are intended to familiarize you with your vehicle. You will also become quickly acquainted with the available control concepts and options.

# Cockpit

## All around the steering wheel

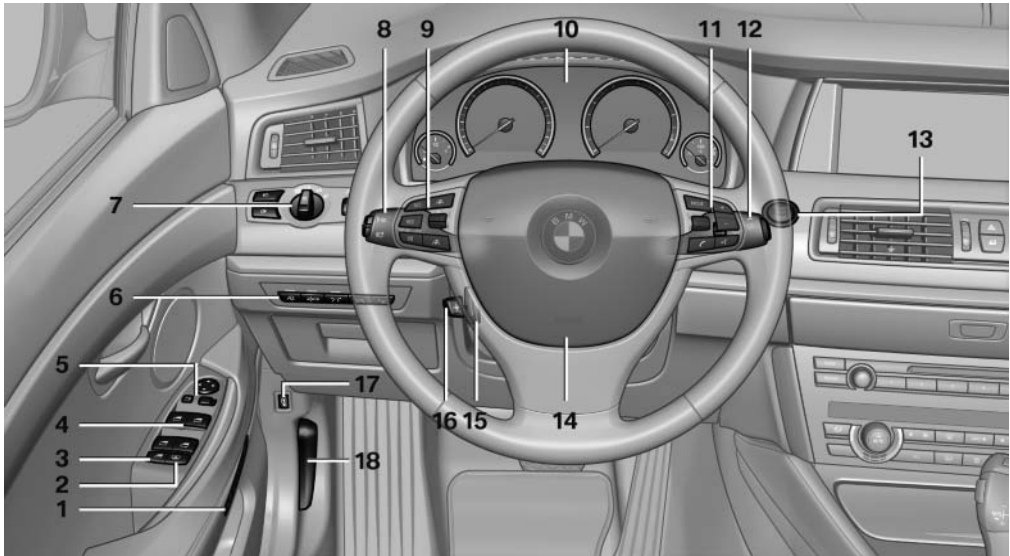

### 1 Seating comfort functions\*



Seat, mirror, steering wheel memory\* [58](#)



Active seat\* [52](#)

### 2 Roller sunblinds\* [46](#)

### 3 Safety switch for the rear windows and roller sunblinds\* [46](#)

### 4 Power windows [45](#)

### 5 Exterior mirror operation [59](#)

### 6 Driver assistance systems\*



Active Blind Spot Detection\* [96](#)



Collision warning\* [112](#)



Lane departure warning\* [95](#)



Night Vision with pedestrian detection\* [122](#)



Head-up Display\* [125](#)

### 7 Lamps



Front fog lamps [88](#)



Parking lamps [85](#)



Low beams [85](#)



Automatic headlamp control\* [86](#)

Daytime running lights\* [86](#)

Adaptive light control\* [86](#)

High-beam Assistant\* [87](#)



Instrument lighting [88](#)



**8** Steering column stalk, left



Turn signal 71



High beams, head-lamp flasher 71



High-beam Assistant\* 87



Roadside parking lamps 86



Computer 78

**9** Steering wheel buttons, left



Store speed 114, 107



Resume speed 115, 108



Cruise control on/off, interrupt 114, 106



Increase distance\* 108



Decrease distance\* 108

**10** Instrument cluster 14

**11** Steering wheel buttons, right



Entertainment source



Volume



Voice activation\* 25



Telephone\* 210

**12** Steering column stalk, right



Windshield wipers 71



Rain sensor\* 72



Clean the windshields and head-lamps\* 71

**13**  Start/stop the engine and switch the ignition on/off 66

**14** Horn

**15**  Steering wheel heating\* 61

**16**  Adjust the steering wheel 61

**17**  Open the tailgate\* 40

**18** Unlocking the hood

## Instrument cluster

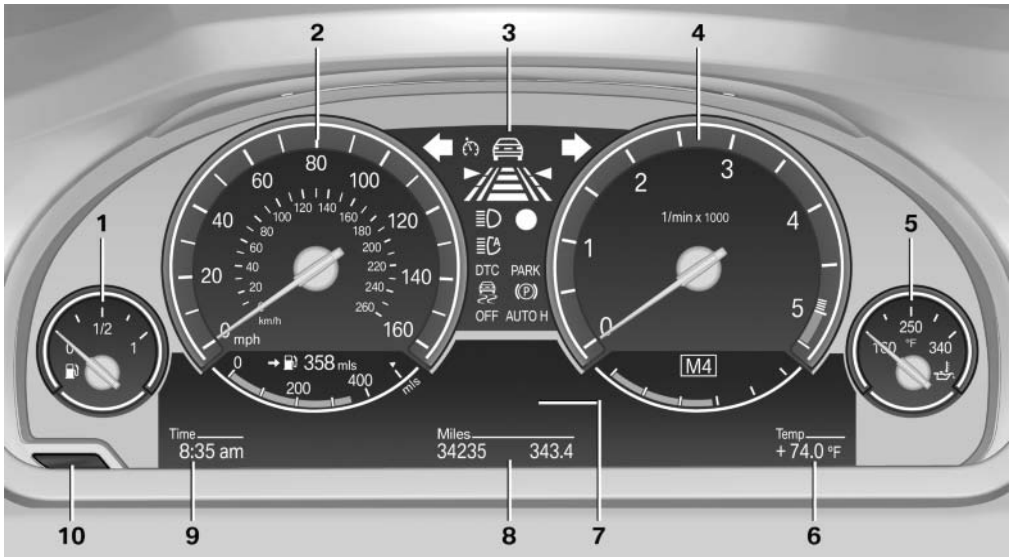

- |  |   |
|--|---|
| 1 Fuel gauge <a href="#">76</a>              | 6 External temperature <a href="#">77</a> |
| 2 Speedometer                                | 7 Electronic displays <a href="#">16</a>  |
| 3 Indicator/warning lamps <a href="#">14</a> | 8 Miles, trip miles <a href="#">78</a>    |
| 4 Tachometer <a href="#">77</a>              | 9 Clock <a href="#">81</a>                |
| 5 Engine oil temperature <a href="#">77</a>  | 10 Reset miles <a href="#">78</a>         |

## Indicator/warning lamps

### Instrument cluster





















The indicator and warning lamps can light up in a variety of combinations and colors.

Several of the lamps are checked for proper functioning when the engine is started or the ignition is switched on, and light up briefly in the process.

### Overview: indicator/warning lamps

Symbol	Function or system
	Turn signal
	Parking brake
	Parking brake in Canadian models
	Automatic Hold*
	Front fog lamps*

Symbol	Function or system
	High beams
	High-beam Assistant*
	Parking lamps, headlamp control
	Active Cruise Control*
	Vehicle detection, Active Cruise Control*
	Cruise control*
	Lane departure warning*
	DSC Dynamic Stability Control
	DSC Dynamic Stability Control or DTC Dynamic Traction Control
	Tire Pressure Monitor*
	Safety belts
	Airbag system

Symbol	Function or system
	Steering system
	Emissions
	Brake system
	Brake system in Canadian models
	Antilock Brake System ABS
	Antilock Brake System ABS in Canadian models

### Text messages

Text messages in combination with a symbol in the instrument cluster explain a Check Control message and the meaning of the indicator and warning lamps.

### Supplementary text messages

Additional information on the Control Display, e.g., on the cause of a malfunction or the required action, can be called up via Check Control, refer to page 83.

The text of urgent messages is displayed automatically.



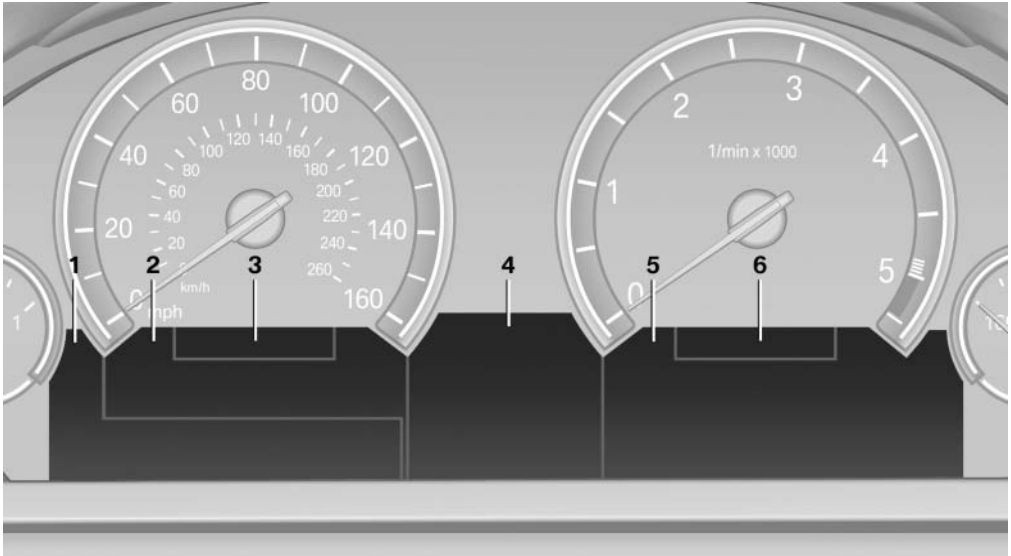



## Instrument cluster, electronic displays

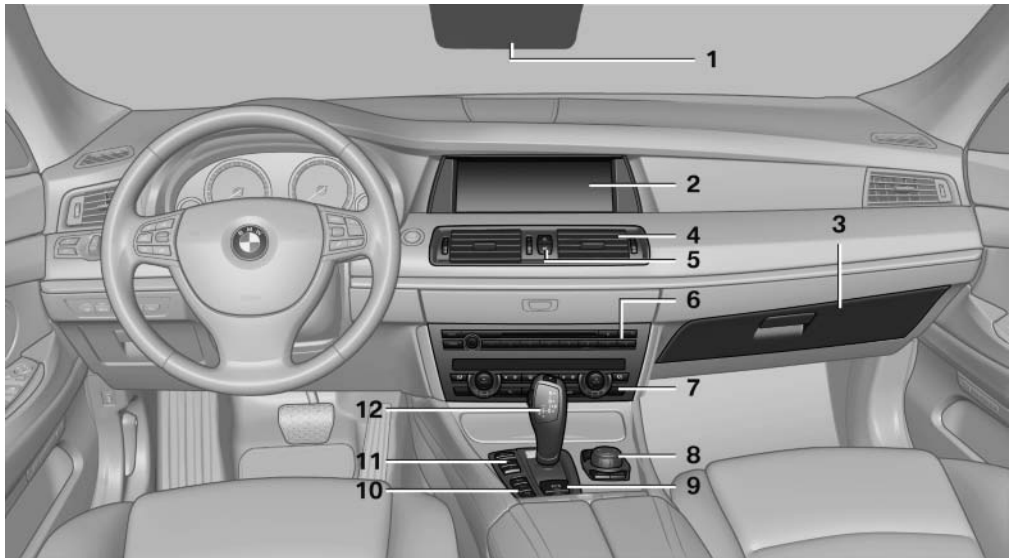

- 1 Symbols and messages, e.g., warnings [14](#)
- 2 Range [76](#)
- 3 Computer\* [78](#)
- 4 Navigation display\* [154](#)  
Service display [82](#)
- 5 Selection list, for instance radio [78](#)
- 6 Transmission displays [75](#)





## All around the center console

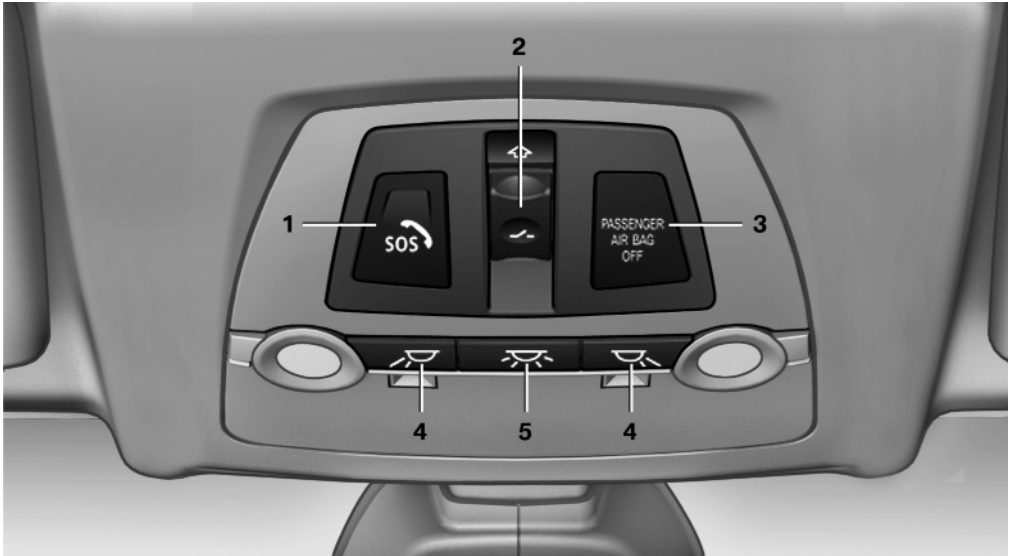

- |   |   |
|---|---|
| <p><b>1</b> Headliner <a href="#">18</a></p> <p><b>2</b> Control Display <a href="#">19</a></p> <p><b>3</b> Glove compartment <a href="#">139</a></p> <p><b>4</b> Air vent <a href="#">130</a></p> <p><b>5</b>  Hazard warning system <a href="#">264</a></p> <p> Central locking system <a href="#">38</a></p> <p><b>6</b> Radio <a href="#">174</a><br/>CD/Multimedia <a href="#">181</a></p> <p><b>7</b> Automatic climate control <a href="#">127</a></p> <p><b>8</b> Controller with buttons <a href="#">19</a></p> <p><b>9</b>  Parking brake <a href="#">67</a></p> <p> Auto Hold <a href="#">69</a></p> | <p><b>10</b>  PDC Park Distance Control* <a href="#">115</a><br/>Top View* <a href="#">117</a><br/>Backup camera* <a href="#">119</a><br/>Side View* <a href="#">121</a></p> <p><b>11</b>  Dynamic Driving Control <a href="#">103</a></p> <p> DSC Dynamic Stability Control <a href="#">103</a></p> <p><b>12</b> Transmission selector lever</p> |
|---|---|

## All around the headliner



- |   |   |  |   |   |                                   |
|---|---|--|---|---|-----------------------------------|
| 1 |  | Emergency Request* <a href="#">264</a>                     | 4 |  | Reading lamps* <a href="#">88</a> |
| 2 |  | Panoramic glass sunroof* <a href="#">47</a>                | 5 |  | Interior lamps <a href="#">88</a> |
| 3 |  | Indicator lamp, front passenger airbag* <a href="#">91</a> |   |   |                                   |

## The concept

The iDrive combines the functions of a multitude of switches. Thus, these functions can be operated from a central location.



Using the iDrive during a trip

To avoid becoming distracted and posing an unnecessary hazard to your vehicle's occupants and to other road users, never attempt to use the controls or enter information unless traffic and road conditions allow this. ◀

## Controls at a glance

### Controls



- 1 Control Display
- 2 Controller with buttons

The buttons can be used to open the menus directly. The controller can be used to select menu items and create the settings.

### Control Display

#### Notes

- ▷ To clean the Control Display, follow the care instructions.
- ▷ Do not place objects close to the Control Display; otherwise, the Control Display can be damaged.

### Switching off

1.  Press the button.
2. "Switch off control display"

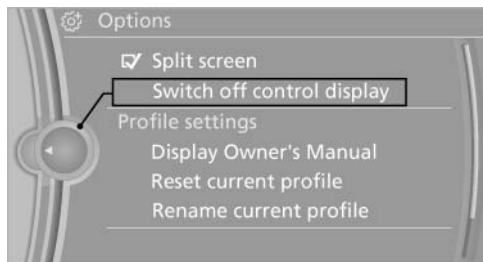

### Switching on

Press the controller again to switch the screen back on.

### Controller

Select menu items and create settings.

1. Turn.

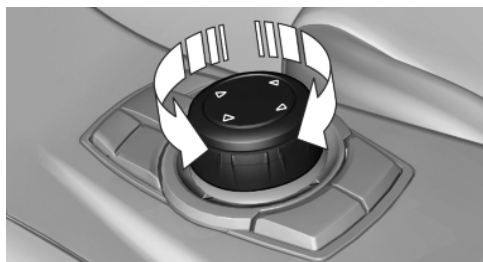

2. Press.



3. Move in four directions.

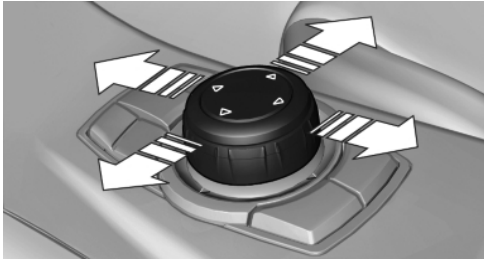

### Buttons on controller

Press the button	Function
MENU	Open the main menu.
RADIO	Opens the Radio menu.
CD	Opens the CD/Multimedia menu.
NAV	Opens the Navigation map view.
TEL	Opens the Telephone menu.
BACK	Displays the previous panel.
OPTION	Opens the Options menu.

## Operating concept

### Opening the main menu



Press the button.

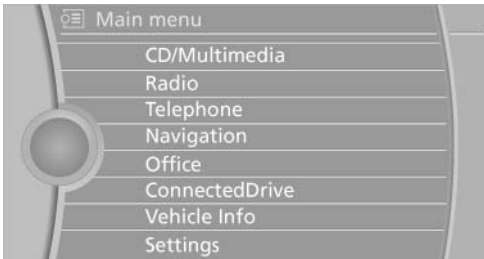

The main menu is displayed.

All iDrive functions can be called up via the main menu.

### Selecting menu items

Menu items shown in white can be selected.

1. Turn the controller until the desired menu item is highlighted.

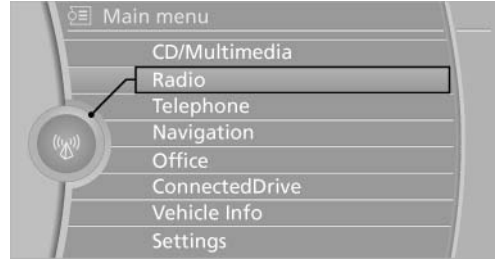

2. Press the controller.

### Menu items in the Owner's Manual

In the Owner's Manual, menu items that can be selected are set in quotation marks, e.g., "Settings".

### Changing between panels

After a menu item is selected, e.g., "Radio", a new panel is displayed. Panels can overlap.

▶ Move the controller to the left.

The current panel is closed and the previous panel is displayed.

The previous panel is opened again by pressing the BACK button. In this case, the current panel is not closed.

▶ Move the controller to the right.

A new panel is opened on top of the previous display.

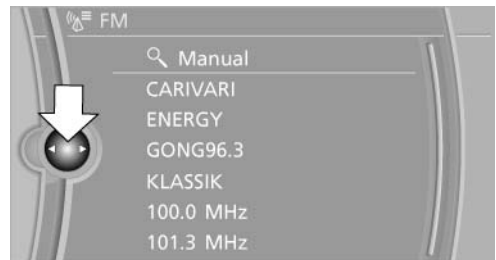



White arrows pointing to the left or right indicate that additional panels can be opened.

## View of an opened menu

When a menu is opened, it generally opens with the panel that was last selected in that menu. To display the first panel of a menu:

- ▶ Move the controller to the left repeatedly until the first panel is displayed.
- ▶ Press the menu button on the controller twice.

## Opening the Options menu

 Press the button.

The "Options" menu is displayed.



Additional options: move the controller to the right repeatedly until the "Options" menu is displayed.

## Options menu

The "Options" menu consists of various areas:

- ▶ Screen settings, e.g., "Split screen". This area remains unchanged.
- ▶ Control options for the selected main menu, e.g., for "Radio".
- ▶ If applicable, further operating options for the selected menu, e.g., "Store station".

## Changing settings

1. Select a field.

2. Turn the controller until the desired setting is displayed.

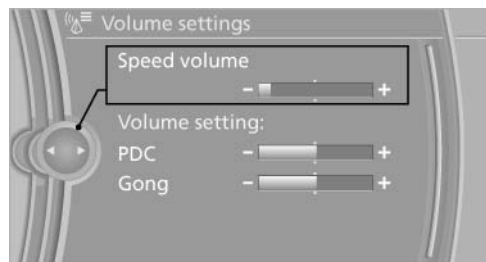

3. Press the controller.

## Activating/deactivating the functions

Several menu items are preceded by a check-box. It indicates whether the function is activated or deactivated. Selecting the menu item activates or deactivates the function.

- The function is activated.
- The function is deactivated.

## Example: setting the clock

### Setting the clock

1.  Press the button. The main menu is displayed.
2. Turn the controller until "Settings" is highlighted, and then press the controller.

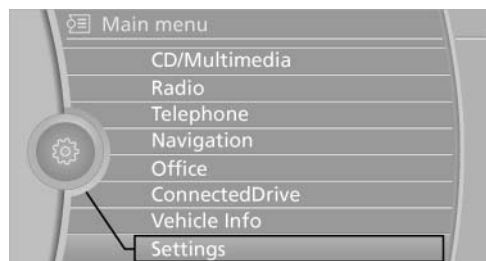

3. If necessary, move the controller to the left to display "Time/Date".

- Turn the controller until "Time/Date" is highlighted, and then press the controller.

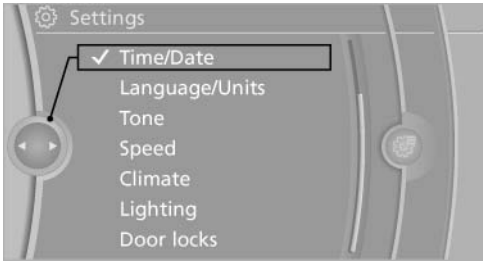

- Turn the controller until "Time:" is highlighted, and then press the controller.

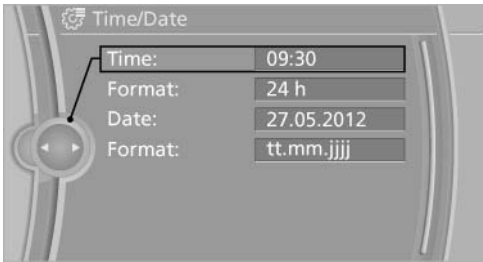

- Turn the controller to set the hours and press the controller.
- Turn the controller to set the minutes and press the controller.

## Status information

### Status field

The following information is displayed in the status field at the top right:

- ▷ Time.
- ▷ Current entertainment source.
- ▷ Sound output, on/off.
- ▷ Wireless network reception strength.
- ▷ Telephone status.
- ▷ Traffic bulletin reception\*.

### Status field symbols

The symbols are grouped as follows.

## Radio symbols



Symbol	Meaning
	Traffic bulletins* are switched on.
	HD Radio™* is switched on.
	Satellite radio* is switched on.

## Telephone symbols



Symbol	Meaning
	Incoming or outgoing call*.
	Missed call*.
	Wireless network reception strength* Symbol flashes: searching for network.
	Wireless network is not available*.
	Bluetooth* is switched on.
	Roaming* is active.
	Text message* was received.
	Check the SIM card*.
	SIM card* is blocked.
	SIM card* is missing.
	Enter the PIN*.

## Entertainment symbols

Symbol	Meaning
	CD/DVD* player.
	Music collection*.
	Gracenote® database*.
	AUX-IN port.
	Rear AUX-IN port on the left*.
	Rear AUX-IN port on the right*.

Symbol	Meaning
	USB audio interface*.
	Mobile phone audio interface*.

## Additional symbols

Symbol	Meaning
	Spoken instructions* are switched off.
	Request of the current vehicle position*.

## Split screen\*

### General information

Additional information can be displayed on the right side of the split screen, e.g., information from the computer.

In the divided screen view, the so-called split screen, this information remains visible even when you change to another menu.

### Switching the split screen on and off

-  Press the button.
- "Split screen"

### Selecting the display

-  Press the button.
- "Split screen"
- Move the controller until the split screen is selected.

- Press the controller or select "Split screen content".
- Select the desired menu item.

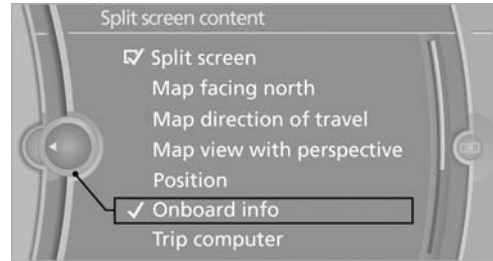



## Programmable memory buttons

### General information



The iDrive functions can be stored on the programmable memory buttons and called up directly, e.g., radio stations, navigation destinations, phone numbers and entry points into the menu.

The settings are stored for the remote control currently in use.

### Saving a function

- Highlight the function via the iDrive.
- ... Press the desired button for more than 2 seconds.

### Running a function

- ... Press the button. The function will run immediately. This means, for example, that the number is dialed when a phone number is selected.

### Displaying the button assignment

Use a finger to touch the buttons. Do not wear gloves or use objects.

The key assignment is displayed at the top edge of the screen.

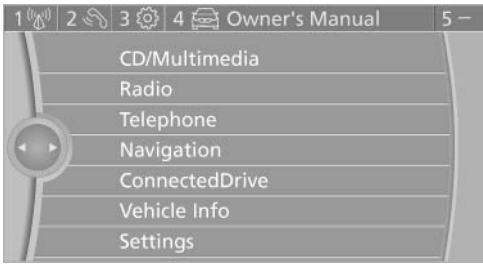

- ▷ To display short information: touch the button.
- ▷ To display detailed information: touch the button for an extended period.

### Deleting the button assignments

1. Press buttons 1 and 8 simultaneously for approx. five seconds.
2. "OK"

## Entering letters and numbers

1. Turn the controller: select letters or numbers.
2. Select additional letters or numbers if needed.
3. "OK": confirm the entry.

Symbol	Function
⬅	Press the controller: delete the letter or number.
⬅	Press the controller for an extended period: delete all letters or numbers.
⏏	Enter a blank space.

### Switching between letters and numbers

Depending on the menu, you can switch between entering letters and numbers:

Symbol	Function
A <sup>B</sup> C	Enter the letters.
1@+	Enter the numbers.

### Switching between upper and lower case letters

Depending on the menu, you can switch between entering upper and lower case letters:

Symbol	Function
▲ abc	Move the controller up: switch from upper to lower case letters.
▲ ABC	Move the controller up: switch from lower to upper case letters.

### Entry comparison

Entry of names and addresses: the selection is narrowed down every time a letter is entered and letters may be added automatically.

The entries are continuously compared to the data stored in the vehicle.

- ▷ Only those letters are offered during the entry for which data is available.
- ▷ Destination search: town/city names can be entered using the spelling of language available on the Control Display.

# Voice activation system\*

## The concept

- ▶ The voice activation system can be used to operate functions by means of spoken commands.
- ▶ Most menu items on the Control Display can be voiced as commands. The system prompts you to make your entries.
- ▶ Functions that can only be used when the vehicle is stationary cannot be operated using the voice activation system.
- ▶ The system uses a special microphone on the driver's side.
- ▶ ›...‹ Verbal instructions in the Owner's Manual to use with the voice activation system.

## Requirements

Via the Control Display, set a language that is also supported by the voice activation system so that the spoken commands can be identified.

Set the language, refer to page 82.

## Using voice activation

### Activating the voice activation system

1.  Press the button on the steering wheel.
2. Wait for the signal.
3. Say the command.  
The command is displayed in the instrument cluster.

 This symbol in the instrument cluster indicates that the voice activation system is active.

If no other commands are available, continue operating the function via iDrive.

### Terminating the voice activation system

Briefly press the button on the steering wheel or ›Cancel‹.

## Possible commands

### Having possible commands read aloud

The commands available in each case depend on the menu item selected on the Control Display.

To have the available commands read out loud: ›Voice commands‹

For example, if the "Settings" menu is displayed, the commands for the settings are read out loud.

### Help dialog for the voice activation system

Calling up help dialog: ›Help‹

Additional commands for the help dialog:



- ▶ ›Help with examples‹: information about the current operating options and the most important commands for them are announced.
- ▶ ›Help with voice activation‹: information about the principle of operation for the voice activation system is announced.

### Executing functions using short commands

Functions on the main menu can be performed directly by means of short commands, irrespective of which menu item is currently selected, e.g., ›Vehicle status‹.

List of short commands of the voice activation system, refer to page 277.

## Example: playing back a CD

1. Switch on the Entertainment sound output if necessary.
2.  Press the button on the steering wheel.
3. >C D and multimedia<  
The medium last played is played back.
4.  Press the button on the steering wheel.
5. >C D track ...< e.g., CD track 4.

## Setting the voice dialog

You can set whether the system should use the standard dialog or a shorter version.

In the shorter variant of the voice dialog, the announcements from the system are issued in an abbreviated form.

On the Control Display:

1. "Settings"
2. "Language/Units"
3. "Speech mode:"
4. Select the setting.

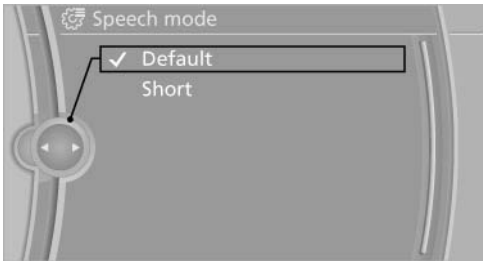

## Adjusting the volume

Turn the volume button while giving an instruction until the desired volume is set.

- ▶ The volume remains constant even if the volume of other audio sources is changed.

- ▶ The volume is stored for the remote control currently in use.

## Notes on Emergency Requests

Do not use the voice activation system to initiate an Emergency Request. In stressful situations, the voice and vocal pitch can change. This can unnecessarily delay the establishment of a telephone connection.

Instead, use the SOS button\*, refer to page 264, in the vicinity of the interior mirror.

## Environmental conditions

- ▶ Say the commands, numbers, and letters smoothly and with normal volume, emphasis, and speed.
- ▶ Always say commands in the language of the voice activation system.
- ▶ When selecting a radio station, use the common pronunciation of the station name.
- ▶ Keep the doors, windows, and glass sun-roof\* closed to prevent noise interference.
- ▶ Avoid making other noise in the vehicle while speaking.

# Integrated Owner's Manual in the vehicle

The integrated Owner's Manual can be displayed on the Control Display. The equipment and functions that are in the vehicle are described therein.

## Components of the integrated Owner's Manual

The integrated Owner's Manual consists of three parts, which offer various levels of information or access possibilities.

### Quick Reference Guide

Located in the Quick Reference is important information for the operation of the vehicle, the operation of basic vehicle functions or for what to do in the event of a flat tire. This information can also be displayed during driving.

### Search by pictures

Information and descriptions based on illustrations can be searched via search by pictures. This is helpful, for example, if the description of an outfitting package that cannot be named is needed.

### Owner's Manual

Information and descriptions can be searched by direct entry of a search term via the index.

### Select components

1.  Press the button.
2. Turn the controller: open "Vehicle Info".
3. Press the controller.
4. Selecting desired range:
  - ▷ "Quick reference"
  - ▷ "Search by pictures"

- ▷ "Owner's Manual"

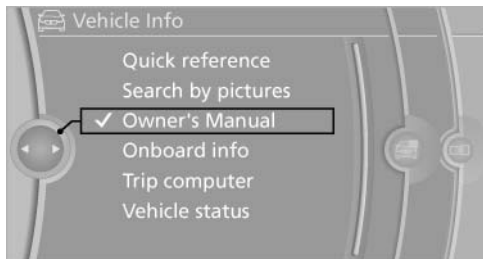

## Leafing through the Owner's Manual

### Page by page with link access

Turn the controller until the next or previous page is displayed.

### Page by page without link access

Leaf through the pages directly while skipping the links.

Highlight the symbol once. Now simply press the controller to leaf from page to page.



Leaf back.



Leaf forward.

## Context help - Owner's Manual to the temporarily selected function

The relevant information can be opened directly.

### Opening during operation via iDrive

To move directly from the application on the Control Display to the options menu:

1.  Press the button or move the controller to the right repeatedly until the "Options" menu is displayed.
2. "Display Owner's Manual"



## Opening when a Check Control message is displayed

Directly from the Check Control message on the Control Display:

"Display Owner's Manual"

## Changing between a function and the Owner's Manual

To change from a function, e.g., radio, to the Owner's Manual on the Control Display and to switch between the two displays:

1.  Press the button or move the controller to the right repeatedly until the "Options" menu is displayed.
2. "Display Owner's Manual"
3. Select the desired page in the Owner's Manual.
4.  Press the button again to return to the function displayed last.
5.  Press the button to return to the page of the Owner's Manual displayed last.



To switch back and forth repeatedly between the function displayed last and the page of the Owner's Manual displayed last, repeat steps 4 and 5. This opens a new panel every time.

## Programmable memory buttons



### General information

The Owner's Manual can be stored on the programmable memory buttons and called up directly.

### Storing

1. Select "Owner's Manual" via the iDrive.
2. ... Press the desired button for more than 2 seconds.

### Executing

1. ... Press the button. The Owner's Manual is displayed immediately.







## Controls

This chapter is intended to provide you with information that will give you complete control of your vehicle. All features and accessories that are useful for driving and your safety, comfort and convenience are described here.

# Opening and closing

## Remote control/key

### Buttons on the remote control

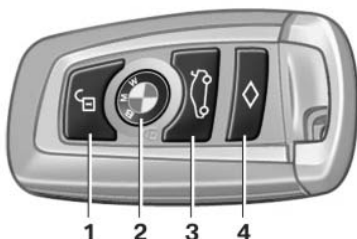

- 1 Unlocking
- 2 Locking
- 3 Opening the small tailgate
- 4 Panic mode\*, headlamp courtesy delay feature, opening the large tailgate\*

### General information

The vehicle is supplied with two remote controls with keys.

Every remote control contains a replaceable battery.

The settings called up and implemented when the vehicle is unlocked depend on which remote control is used to unlock the vehicle, Personal Profile, refer to page 33.

In addition, information about service requirements is stored in the remote control, Service data in the remote control, refer to page 256.

## Integrated key

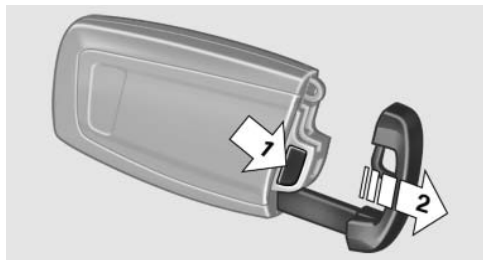

Press the button on the back of the remote control, arrow 1, and pull out the key, arrow 2.

The integrated key fits the following locks:

- ▷ Driver's door.
- ▷ Storage compartment in the front center armrest.

The storage compartment contains a switch for separately securing the tailgate, refer to page 42.

## Replacing the battery

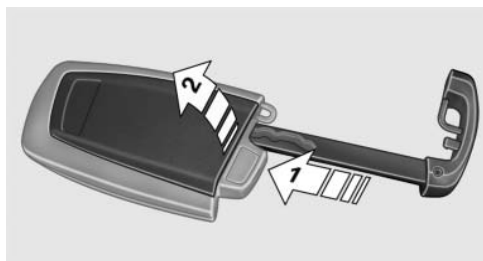

1. Take the integrated key out of the remote control.
2. Push in the catch with the key, arrow 1.
3. Remove the cover of the battery compartment; see arrow 2.
4. Insert a battery of the same type with the positive side facing upwards.
5. Press the cover closed.



Take the used battery to a recycling center or to your service center.

## New remote controls

You can obtain new remote controls from your service center.

## Loss of the remote controls

Lost remote controls can be blocked by your service center.

## Emergency detection of remote control

It is possible to switch on the ignition or start the engine in situations such as the following:

- ▷ Interference of radio transmission to remote control by external sources.
- ▷ Discharged battery in the remote control.

A Check Control message is displayed if an attempt is made to switch on the ignition or start the engine.

## Starting the engine in case of emergency detection of remote control



If a corresponding Check Control message appears, hold the remote control, as shown, against the marked area on the steering column and press the Start/Stop button within 10 seconds while pressing the brake.

## Personal Profile

### The concept

#### Personal Profile concept

You can set several of your vehicle's functions to suit your personal needs and preferences.

- ▷ The settings are automatically saved in the profile currently activated.

- ▷ When the vehicle is unlocked, the profile that was last detected and called up with the remote control is used.
- ▷ Your personal settings will be recognized and called up again even if the vehicle has been used in the meantime by someone else with another remote control.

The individual settings are stored for three Personal Profiles and one guest profile.

## Transmitting the settings

Your personal settings can be taken with you to another vehicle equipped with the Personal Profile function. For more information, contact your service center.

Transmission takes place via:

- ▷ The USB interface\*, refer to page 139, in the glove compartment onto a USB device.

## Profile management

### Opening the profiles

A different profile can be called up than the one associated with the remote control currently in use.

1. "Settings"
2. "Profiles"

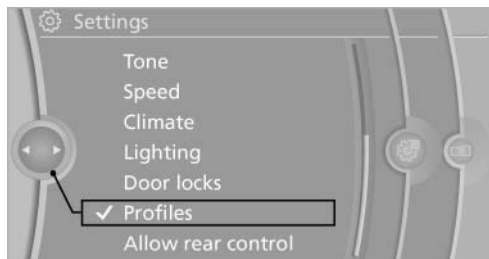

3. Select a profile.

The profile that is opened is assigned to the remote control currently in use.

### Renaming profiles

1. "Settings"
2. "Profiles"

The current profile is selected.

3. Open "Options".
4. "Rename current profile"

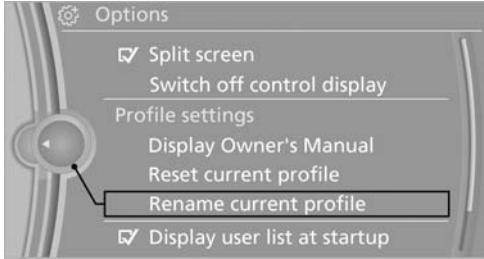

## Resetting profiles

The settings of the active profile are reset to their default values.

1. "Settings"
2. "Profiles"
  - The current profile is selected.
3. Open "Options".
4. "Reset current profile"

## Importing profiles

Existing settings and contacts are overwritten with the imported profile.

1. "Settings"
2. "Profiles"
3. "Import profile"

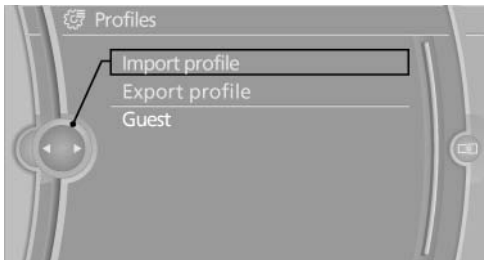

4. USB interface, refer to page 139: "USB device"

## Exporting profiles

Most settings of the active profile and the saved contacts can be exported.

This can be useful for storing and opening personal settings, for instance if settings are accidentally changed or deleted.

1. "Settings"
2. "Profiles"
3. "Export profile"
4. USB interface, refer to page 139: "USB device"

## Using the guest profile

The guest profile can be used to make individual settings without affecting the three Personal Profiles.

This can be useful for drivers who are using the vehicle temporarily and do not have their own profile.

1. "Settings"
2. "Profiles"
3. The current profile is selected.
4. Open "Guest".
5. Create the settings.

Note: the guest profile cannot be renamed.

## Display profile list during start

The profile list can be displayed during each start for selecting the desired profile.

1. "Settings"
2. "Profiles"
3. Open "Options".
4. "Display user list at startup"

## Personal Profile settings

The following functions and settings can be stored in a profile.

More information on the settings can be found under:

- ▷ Active Cruise Control: collision warning, refer to page 112.
- ▷ Exterior mirror position, refer to page 59.
- ▷ CD/Multimedia, refer to page 181: audio source listened to last.

- ▷ Dynamic Driving Control: sport program, refer to page 104.
- ▷ Driver's seat position, refer to page 37: automatic retrieval after unlocking.
- ▷ Programmable memory buttons, refer to page 23: assignment.
- ▷ Head-up Display, refer to page 125: selection, brightness and position of the display.
- ▷ Headlamp courtesy delay feature, refer to page 85: time setting.
- ▷ Tone, refer to page 172: tone settings.
- ▷ Automatic climate control, refer to page 127: settings.
- ▷ Steering wheel position, refer to page 61
- ▷ Navigation, refer to page 154: map views, route criteria, voice output on/off.
- ▷ Night Vision with pedestrian detection, refer to page 122: selection of functions and type of display.
- ▷ Daytime running lights\*, refer to page 86: current setting.
- ▷ Park Distance Control PDC, refer to page 173: adjusting the signal tone volume.
- ▷ Radio, refer to page 174: stored stations, station listened to last, special settings.
- ▷ Backup camera, refer to page 119: selection of functions and type of display.
- ▷ Side View, refer to page 121: selection of the display type.
- ▷ Language on the Control Display, refer to page 82.
- ▷ Lane departure warning, refer to page 95: last setting, on/off.
- ▷ Active Blind Spot Detection, refer to page 96: last setting, on/off.
- ▷ Triple turn signal activation, refer to page 71.
- ▷ Locking the vehicle, refer to page 39: after a brief period or after starting to drive.

## Central locking system

### The concept

The central locking system becomes active when the driver's door is closed.

The system simultaneously engages and releases the locks on the following:

- ▷ Doors.
- ▷ Tailgate.
- ▷ Fuel filler flap.

### Operating from the outside

- ▷ Via the remote control.
- ▷ Via the driver's door lock\*.
- ▷ Via the door handles\*.
- ▷ Via the button on the tailgate\*.

The following takes place simultaneously when locking/unlocking the vehicle via the remote control:

- ▷ Anti-theft protection is switched on/off. Doors cannot be unlocked using the lock buttons or the door opener.
- ▷ The welcome lamps, interior lamps and courtesy lamps\* are switched on and off.
- ▷ The alarm system\*, refer to page 44, is armed or disarmed.

### Operating from the inside



Via the button for the central locking system.

If the vehicle has been locked from inside, the fuel filler flap remains unlocked.

If an accident of a certain severity occurs, the central locking system unlocks automatically.

The hazard warning system and interior lamps come on.

## Opening and closing: from the outside

### Using the remote control

#### General information

 Take the remote control with you. People or animals left unattended in a parked vehicle can lock the doors from the inside. Always take the remote control with you when leaving the vehicle so that the vehicle can then be opened from the outside. ◀

#### Unlocking

 Press the button. The vehicle is unlocked.

You can set how the vehicle is to be unlocked. The setting is stored for the remote control currently in use.

1. "Settings"
2. "Door locks"
3. "Unlock button:"

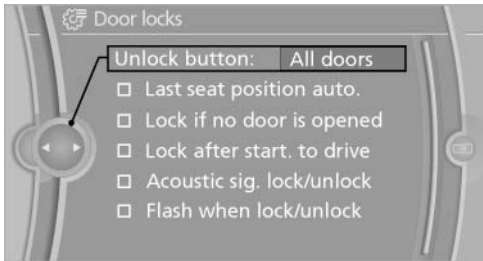

4. Select the desired function:
  - ▷ "Driver's door only"
 

Only the driver's door and the fuel filler flap are unlocked. Pressing again unlocks the entire vehicle.
  - ▷ "All doors"
 

The entire vehicle is unlocked.

### Convenient opening

The remote control can be used to simultaneously open the windows and the glass sunroof\*.

 Press and hold the button on the remote control.

The windows and the glass sunroof\* open. Releasing the button stops the motion.

### Locking

 Press the button on the remote control.

 Do not lock from the outside. Do not lock the vehicle from the outside if there are people in it, as the vehicle cannot be unlocked from inside without special knowledge. ◀

### Switching on the interior lamps, courtesy lamps\*, and welcome lamps

 Press the button on the remote control with the vehicle locked.

### Panic mode\*

You can trigger the alarm system if you find yourself in a dangerous situation.

 Press the button on the remote control for at least 3 seconds.

To switch off the alarm: press any button.

### Switching on the headlamp courtesy delay feature

 Briefly press the button on the remote control.

The duration can be set in the Control Display.

### Opening the tailgate

 Press the button on the remote control for approx. 1 second.

The small tailgate opens slightly.

The tailgate pivots back and up when it opens. Ensure that adequate clearance is available before opening.



With automatic trunk lid operation\*:



Press the button on the remote control for approx. 1 second and release.

The large tailgate opens automatically.



Note the opening height of the large tailgate

The tailgate pivots back and up when it opens. Ensure that there is sufficient clearance when the large tailgate opens; otherwise, damage may result. ◀

The tailgate opens, regardless of whether it was previously locked or unlocked.

In some vehicle equipment variants, the tailgate can only be opened using the remote control if the vehicle was unlocked first.

To avoid locking yourself out of the vehicle, do not place the remote control into the cargo area. The tailgate is locked again as soon as it is pushed closed.



Provide edge protection

Sharp or angular objects can hit the rear window while driving and damage the heating wires of the rear window. Provide edge protection. ◀

## Confirmation signals from the vehicle

1. "Settings"
2. "Door locks"
3. Deactivate or activate the desired confirmation signals.
  - ▷ "Acoustic sig. lock/unlock"
  - ▷ "Flash when lock/unlock"

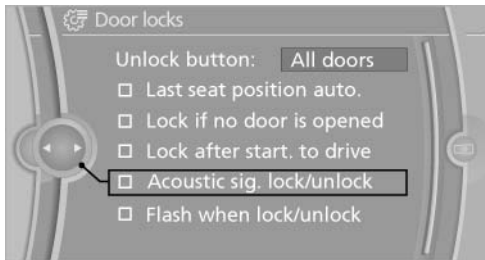

## Retrieving the seat, mirror, and steering wheel settings

The driver's seat, exterior mirror, and steering wheel positions selected last are stored for the currently used remote control.

When the vehicle is unlocked, these positions are automatically retrieved if this function was activated.



Pinch hazard when moving back the seat

If this function is used, first make sure that the footwell behind the driver's seat is empty. Otherwise, people can be injured or objects damaged when the seat is moved back. ◀

The adjustment procedure is interrupted:

- ▷ When a seat position switch is pressed.
- ▷ When a button of the seat, mirror, and steering wheel memory is pressed briefly.

## Activating the setting

1. "Settings"
2. "Door locks"
3. "Last seat position auto."

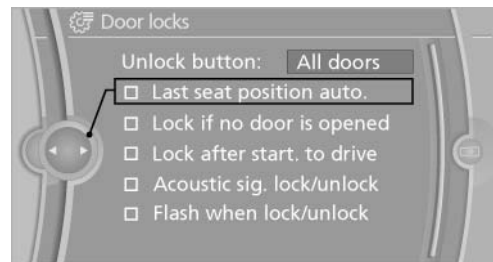

## Malfunction

If the vehicle can no longer be locked or unlocked with the remote control, the battery may be discharged or there may be interference from external sources such as mobile phones, metal objects, overhead power lines, transmission towers, etc.

If this occurs, unlock or lock the vehicle at the door lock using the key.

## For US owners only

The transmitter and receiver units comply with part 15 of the FCC/Federal Communication Commission regulations. Operation is governed by the following:

FCC ID:

- ▷ LX8766S.
- ▷ LX8766E.
- ▷ LX8CAS.
- ▷ LX8CAS2.
- ▷ MYTCAS4.

Compliance statement:

This device complies with part 15 of the FCC Rules. Operation is subject to the following two conditions:



- ▷ This device may not cause harmful interference, and
- ▷ this device must accept any interference received, including interference that may cause undesired operation.

Any unauthorized modifications or changes to these devices could void the user's authority to operate this equipment.

## Using the door lock

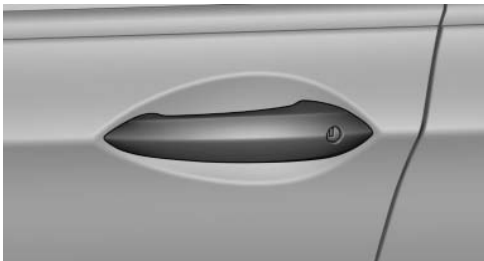
### General information



-  Do not lock from the outside
-  Do not lock the vehicle from the outside if there are people in it, as the vehicle cannot be unlocked from inside without special knowledge. ◀

-  Remove the key before pulling the door handle

Before pulling the outside door handle, remove the key to avoid damaging the paintwork and the key. ◀

In some country-specific versions, the alarm system\* is triggered if the vehicle is unlocked via the door lock.

## Manual operation

If an electrical malfunction occurs, lock or unlock the vehicle using a key via the door lock on the driver's door.

## Locking the doors and tailgate at once\*

In some vehicle equipment versions, only the driver's door can be locked via the door lock.

To lock all doors and the tailgate at once:

1. With the doors closed, lock the vehicle using the button for the central locking system in the interior.
2. Unlock and open the driver's or front passenger door.
3. Lock the vehicle.
  - ▷ Lock the driver's door using the integrated key in the door lock, or
  - ▷ Press down the lock button of the front passenger door and close the door from the outside.

The fuel filler flap can only be locked using the remote control.

## Opening and closing: from the inside



## Unlocking and opening\*

- ▷ Either unlock the doors together using the button for the central locking system and then pull the door handle above the armrest or
- ▷ Pull the door opener twice individually on each door: the first time unlocks the door, the second time opens it.

## Locking and unlocking



Press the button in the vehicle.

The doors and the tailgate are locked or unlocked when the front doors are closed, but they are not secured against theft.

The fuel filler flap remains unlocked.

## Automatic locking

The setting is stored for the remote control currently in use.

1. "Settings"
2. "Door locks"
3. Select the desired function:
  - ▷ "Lock if no door is opened"
 

The vehicle locks automatically after a short period of time if a door is not opened.
  - ▷ "Lock after start. to drive"
 

The vehicle locks automatically after you drive away.

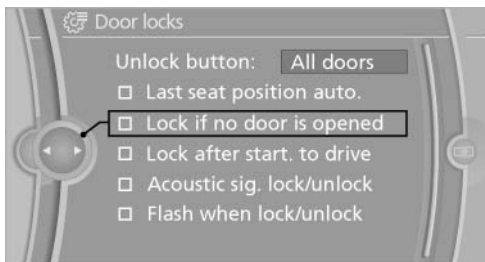

## Doors

### Automatic Soft Closing\*

To close the doors, push lightly.

It is closed automatically.



Danger of pinching

Make sure that the closing path of the doors is clear; otherwise, injuries may result. ◀

## Tailgate



### Opening

#### Opening the small tailgate

The tailgate pivots back and up when it opens.

Ensure that adequate clearance is available before opening.



- ▷ Press the button on the tailgate, arrow 1.
- ▷  Press the button on the remote control for approx. 1 second and release.
- ▷  Push the button in the driver's footwell.

The tailgate is opened if the vehicle is stationary, provided that the tailgate has not been locked.



Provide edge protection

Sharp or angular objects can hit the rear window while driving and damage the heating wires of the rear window. Provide edge protection. ◀

## Opening the large tailgate

 Note the opening height of the large tailgate

The tailgate pivots back and up when it opens. Ensure that there is sufficient clearance when the large tailgate opens; otherwise, damage may result. ◀



Press the button on the tailgate, arrow 2, and open the tailgate.

 Provide edge protection  
Sharp or angular objects can hit the rear window while driving and damage the heating wires of the rear window. Provide edge protection. ◀

## Closing



Recessed grips on the inside trim of the tailgate can be used to conveniently pull down the tailgate.

 Danger of pinching  
Make sure that the closing path of the tailgate is clear; otherwise, injuries may result. ◀

 Do not place the remote control in the cargo area

Take the remote control with you and do not leave it in the cargo area; otherwise, the remote control may be locked inside the vehicle when the tailgate is closed. ◀

## Automatic Soft Closing

To close the tailgate fully, press down lightly only.

It is closed automatically.

## Locking the vehicle\*



Press the button on the open tailgate.  
The vehicle is locked completely.

## Automatic trunk lid operation\*

### Adjusting the opening height

You can set how far the large tailgate should open.

 Adjusting the opening height  
When adjusting the opening height, ensure that there is a clearance of at least 4 in/ 10 cm above the tailgate. Otherwise, the ceiling may not be high enough for the open tailgate if the load situation changes. ◀

1. "Settings"
2. "Tailgate"

- Turn the controller until the desired opening height is selected.



### Opening the large tailgate

**!** Note the opening height of the large tailgate

The tailgate pivots back and up when it opens. Ensure that there is sufficient clearance when the large tailgate opens; otherwise, damage may result.

Adjust the opening height of the large tailgate according to the given situation. ◀

The large tailgate opens automatically to the adjusted opening height.



- Press the button on the exterior of the tailgate, arrow 2.
-  Press the button on the remote control for approx. 1 second and release.

Pressing the button again stops the motion.

The opening process is interrupted as well:

- When starting the engine.
- When the vehicle starts moving.
- By pressing the button in the driver's footwell.

- By pressing the button on the inside of the tailgate.

### Opening the large tailgate further

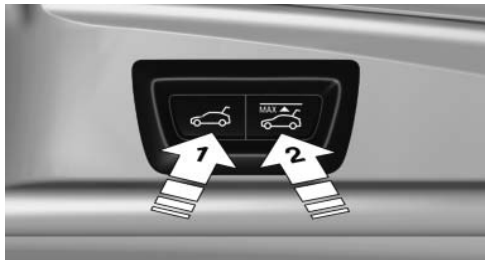

Press and hold the button on the inside of the large tailgate, arrow 2, to open the large tailgate to the maximum opening height.

Releasing the button stops the motion.

### Closing the large tailgate

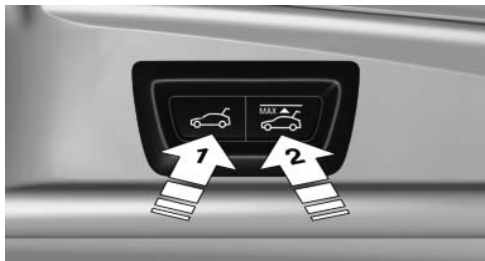

- Press the button, arrow 1, on the inside of the large tailgate.

The tailgate closes automatically.

Pressing again stops the motion.



- With Comfort Access:  
Press the button on the open tailgate.

Tailgate closes automatically and the vehicle is locked.





- ▶ Press the button on the exterior of the tailgate, arrow 2.

Pressing again stops the motion.

The closing operation is interrupted:

- ▶ When starting the engine.
- ▶ The vehicle starts off with jerks.

 **Danger of pinching**  
Make sure that the closing path of the tailgate is clear; otherwise, injuries may result. ◀

 **Do not place the remote control in the cargo area**

Take the remote control with you and do not leave it in the cargo area; otherwise, the remote control may be locked inside the vehicle when the tailgate is closed. ◀

## Manual operation

In the event of an electrical malfunction, operate the unlocked tailgate manually with a slow and smooth motion.

 **Do not operate the tailgate manually if it is blocked**

If the tailgate is blocked, do not operate it manually as the tailgate may otherwise become damaged and injury may result.

Contact your service center. ◀

## Locking separately

The tailgate can be locked separately, using the switch in the front center armrest.



- ▶ The tailgate is locked, arrow 1.  
The small and large tailgates are locked.
- ▶ The tailgate is unlocked, arrow 2.

Slide the switch into the arrow 1 position. This secures the tailgate and disconnects it from the central locking system.

When the center armrest is locked, the tailgate cannot be accessed. This is beneficial when the vehicle is parked using valet service. The infrared remote control can be handed out without the key.

## Emergency unlocking\*



Pull the handle inside the cargo area.  
The tailgate is unlocked.

## Comfort Access\*

### The concept

The vehicle can be accessed without activating the remote control.

All you need to do is to have the remote control with you, e.g., in your jacket pocket.

The vehicle automatically detects the remote control when it is nearby or in the passenger compartment.

Comfort Access supports the following functions:

- ▶ Unlocking/locking of the vehicle.
- ▶ Convenient closing.
- ▶ Unlocking of the tailgate separately.

- ▷ Starting the engine.

## Functional requirements

- ▷ There are no external sources of interference nearby.
- ▷ To lock the vehicle, the remote control must be located outside of the vehicle.
- ▷ The next unlocking and locking cycle is not possible until after approx. 2 seconds.
- ▷ The engine can only be started if the remote control is inside the vehicle.

## Comparison with ordinary remote control

The functions can be controlled by pressing the buttons or via Comfort Access.

## Unlocking

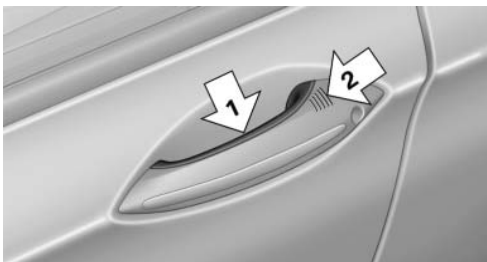

Fully grasp a door handle, arrow 1. This corresponds to pressing the button.

## Locking

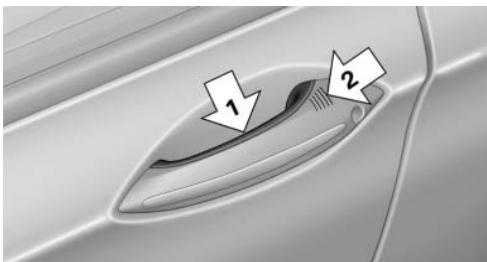

Press the area on the door handle, arrow 2, with your finger for approx. 1 second.

This corresponds to pressing the button.

To save battery power, ensure that the ignition and all electronic systems and/or power con-

sumers are switched off before locking the vehicle.

## Convenient closing

Press the area, arrow 2, with your finger and hold.

In addition to locking, the windows and the glass sunroof\* are closed.



Monitor the closing process

Monitor the closing process to ensure that no one becomes trapped. ◀

## Unlocking the tailgate separately

Press the middle button on the exterior of the tailgate, refer to page 39, to open the small tailgate.

This corresponds to pressing the button.

Press the right-hand button on the exterior of the tailgate to open the large tailgate.

With automatic trunk lid operation\*:

This corresponds to pressing the button.



Do not place the remote control in the cargo area

Take the remote control with you and do not leave it in the cargo area; otherwise, the remote control may be locked inside the vehicle when the tailgate is closed. ◀

## Malfunction

Comfort Access may not function properly if it experiences interference from external sources such as mobile phones, metal objects, overhead power lines, transmission towers, etc.

If this occurs, open or close the vehicle using the buttons on the remote control or use a key in the door lock.

To subsequently start the engine, hold the remote control against the marked area on the steering column, refer to page 33.



## Alarm system\*

### The concept

The vehicle alarm system responds to:

- ▷ Opening of a door, the hood or the tailgate.
- ▷ Movements in the vehicle: interior motion sensor, refer to page 45.
- ▷ Changes in the vehicle tilt, e.g., during attempts to steal a wheel or when towing the car.
- ▷ Interruptions in battery voltage.

The alarm system briefly indicates tampering:

- ▷ By sounding an acoustic alarm.
- ▷ By switching on the hazard warning system.
- ▷ By flashing the high beams.

### Arming and disarming the alarm system

#### General information

When you lock or unlock the vehicle, either with the remote control or at the door lock\*, the alarm system is armed or disarmed at the same time.

#### Door lock and armed alarm system

Unlocking via the door lock will trigger the alarm on some country-specific versions.

#### Tailgate and armed alarm system

The tailgate can be opened using the remote control, even if the alarm system is armed.

- ▷  Press the button on the remote control for approx. 1 second and release.

The small tailgate opens slightly.

- ▷  With automatic trunk lid operation\*: Press the button on the remote control for approx. 1 second and release.

The large tailgate opens automatically.

- ▷  Note the opening height of the large tailgate

The tailgate pivots back and up when it opens. Ensure that there is sufficient clearance when

the large tailgate opens; otherwise, damage may result. ◀

After the tailgate is closed, it is locked and monitored again by the alarm system. The hazard warning system flashes once.

In some vehicle equipment variants, the tailgate can only be opened using the remote control if the vehicle was unlocked first.

#### Panic mode\*



Press the button on the remote control for at least 3 seconds.

#### Switching off the alarm

- ▷ Unlock the vehicle using the remote control.
- ▷ With Comfort Access: If you are carrying the remote control with you, pull on the door handle.

#### Indicator lamp on the interior rearview mirror

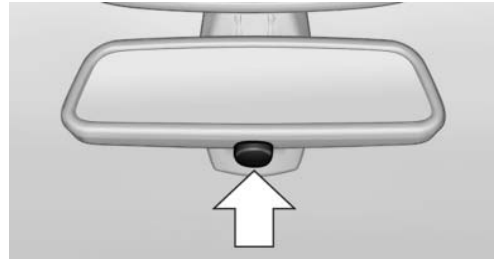

- ▷ The indicator lamp flashes briefly every 2 seconds:  
The system is armed.
- ▷ The indicator lamp flashes after locking:  
The doors, hood or tailgate is not closed properly, but the rest of the vehicle is secured.  
After 10 seconds, the indicator lamp flashes continuously. The interior motion sensor is not active.
- ▷ The indicator lamp goes out after unlocking:  
The vehicle has not been tampered with.



- ▷ The indicator lamp flashes after unlocking until the engine is started, but no longer than approx. 5 minutes:

An alarm has been triggered.

### Tilt alarm sensor

The tilt of the vehicle is monitored.

The alarm system responds in situations such as attempts to steal a wheel or tow the car.

### Interior motion sensor

The windows and glass sunroof\* must be closed for the system to function properly.

### Avoiding unintentional alarms

The tilt alarm sensor and interior motion sensor can be switched off together, such as in the following situations:

- ▷ In automatic car washes
- ▷ In duplex garages.
- ▷ During transport on car-carrying trains, at sea or on a trailer.
- ▷ When animals are to remain in the vehicle.

### Switching off the tilt alarm sensor and interior motion sensor



Press the button on the remote control twice in succession.

The indicator lamp lights up for approx. 2 seconds and then flashes continuously.

The tilt alarm sensor and interior motion sensor are switched off until the vehicle is locked again.

## Power windows

### General information



Take the remote control with you

Take the remote control with you when leaving the vehicle so that children, for example, cannot operate the power windows and injure themselves. ◀



### Opening



- ▷ Press the switch to the resistance point.

The window opens while the switch is held.



- ▷ Press the switch beyond the resistance point.

The window opens automatically.

Pressing again stops the motion.

### Closing



Danger of pinching

Monitor the closing process and make sure that the closing path of the window is clear; otherwise, injuries may result. ◀



- ▷ Pull the switch to the resistance point.

The window closes while the switch is held.



- ▷ Pull the switch beyond the resistance point.

The window closes automatically.

Pressing the switch stops the motion.

Convenient operation, refer to page 36, via the remote control.

Convenient closing, refer to page 43, with Comfort Access\*.

### Pinch protection

If the closing force exceeds a specific value as a window closes, the closing action is interrupted.

The window reopens slightly.

 Danger of pinching even with pinch protection

Even with the pinch protection system, check that the window's closing path is clear; otherwise, the closing action may not stop in certain situations, e.g., if thin objects are present. ◀

 Window accessories

Do not install any accessories in the range of movement of the windows; otherwise, the pinch protection system will be impaired. ◀

## Closing without the pinch protection system

 Danger of pinching

Monitor the closing process and make sure that the closing path of the window is clear; otherwise, injuries may result. ◀

For example, if there is an external danger or if ice on the windows prevents a window from closing normally, proceed as follows:

1. Pull the switch past the resistance point and hold it there.  
Pinch protection is limited and the window reopens slightly if the closing force exceeds a certain value.
2. Pull the switch past the resistance point again within approx. 4 seconds and hold it there.  
The window closes without pinch protection.

## Safety switch

The following functions can be locked simultaneously, using the switch:

- ▷ Opening and closing of the rear windows using the switches in the rear.
- ▷ Operation of the roller sunblinds\* using the switches in the rear.
- ▷ Adjustment of the power rear seats\*.
- ▷ Adjustment of the power head restraints\* in the rear.

## Switching on and off



Press the button.

The LED lights up if the safety function is switched on.



Safety switch for rear operation

Press the safety switch when transporting children in the rear; otherwise, injury may result if the windows are closed without supervision. ◀

## Roller sunblinds\*

### General information

The safety switch in the driver's door can be used to prevent children, for example, from operating the roller blinds using the switches in the rear.

Press the safety switch in the driver's door. The LED lights up if the safety function is switched on.

If you are no longer able to move the roller blinds after having activated them consecutively a number of times, the system is blocked for a limited time to prevent overheating. Let the system cool.

The roller sunblinds cannot be moved at low interior temperatures.

### Driver's door controls



### Roller blinds for rear side windows



Press the button.

## Rear door controls



### Roller blind for the side windows



Press the button.

The roller blind can only be extended or retracted when the side window is closed.

### Raising and lowering the roller blinds together



Press the button.

## Panoramic glass sunroof\*

### General information

The glass sunroof and the sliding visor can be operated together or separately, using the same switch.

The glass sunroof is operational when the ignition is switched on.



Danger of pinching

Monitor the closing process and make sure that the closing path of the glass sunroof is clear; otherwise, injuries may result. ◀



Take the remote control with you

Take the remote control with you when leaving the vehicle so that children, for example, cannot operate the roof and injure themselves. ◀



### Tilting the glass sunroof



Push switch upward briefly.

- ▶ The closed roof is tilted and the sliding visor opens slightly.
- ▶ The opened roof closes until it is in its tilted position. The sliding visor stays completely open.

Pressing the switch again closes the sliding visor almost completely.

### Opening/closing the sliding visor

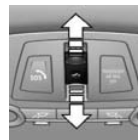

- ▶ Press the switch in the desired direction to the resistance point and hold it there. The sliding visor moves while the switch is being held.

- ▶ Press the switch in the desired direction past the resistance point.

The sliding visor moves automatically.

Pressing the switch again stops the motion.

### Opening/closing the glass sunroof

When the sliding visor is open, proceed as described under Sliding visor.

### Opening/closing the glass sunroof and sliding visor together



Briefly press the switch twice in succession in the desired direction past the resistance point.

The glass sunroof and sliding visor move together. Pressing the switch again stops the motion.

Convenient operation, refer to page 36, via the remote control.

Convenient closing, refer to page 43, with Comfort Access\*.

## Comfort position

In the comfort position, the roof is not fully open. This reduces wind noise in the passenger compartment.

Every time the glass sunroof is opened or closed completely, it stops in the comfort position. If desired, continue the movement by pressing the switch.

## Pinch protection system

If the closing force when closing the glass sunroof exceeds a certain value, the closing movement is stopped, beginning at approximately the middle of the opening in the roof, or from the tilted position during closing.

The glass sunroof opens again slightly.

 Danger of pinching even with pinch protection

Despite the pinch protection system, check that the roof's closing path is clear; otherwise, the closing action may not be interrupted in certain extreme situations, such as when thin objects are present. ◀

## Closing without the pinch protection system

For example, if there is an external danger, proceed as follows:

1. Press the switch forward beyond the resistance point and hold.  
Pinch protection is limited and the roof re-opens slightly if the closing force exceeds a certain value.
2. Press the switch forward again beyond the resistance point and hold until the roof closes without pinch protection.

## Initializing after a power failure

After a power failure during the opening or closing process, the roof can only be operated to a limited extent.

## Initializing the system

The system can be initialized when the vehicle is stationary and the engine is running.

 Danger of pinching

Monitor the closing process and make sure that the closing path of the glass sunroof is clear; otherwise, injuries may result. ◀

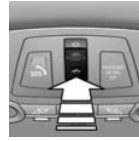

Press the switch up and hold it until the initialization is complete:

- ▶ Initialization begins within 15 seconds and is completed when the sunroof and sliding visor are completely closed.
- ▶ The roof closes without pinch protection.

# Adjusting

## Sitting safely

The ideal seating position can make a vital contribution to relaxed, fatigue-free driving.

The seating position plays an important role in an accident in combination with:

- ▷ Safety belts, refer to page 55.
- ▷ Head restraints, refer to page 56.
- ▷ Airbags, refer to page 89.

## Front seats

### Adjusting

#### General information

 Do not adjust the seat while driving  
Never attempt to adjust the driver's seat while driving.

The seat could respond with unexpected movement and the ensuing loss of vehicle control could lead to an accident. ◀

 Do not incline the backrest too far to the rear

Do not incline the backrest on the front passenger side too far to the rear during driving. Otherwise, there is the danger of sliding under the safety belt in an accident. This would eliminate the protection normally provided by the belt. ◀

The seat setting is stored for the remote control currently in use. When the vehicle is unlocked via the remote control, the position is automatically retrieved if this function, refer to page 37, was activated.

### At a glance: partially powered seats

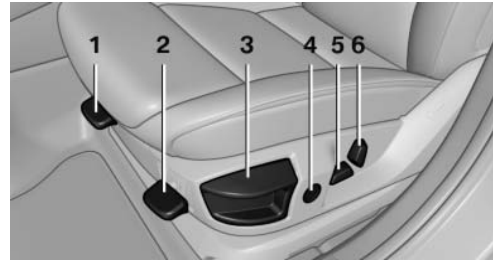

- 1 Thigh support\*
- 2 Tilt
- 3 Forward/backward
- 4 Lumbar support\*
- 5 Height
- 6 Backrest

### Adjustments in detail: partially powered seats

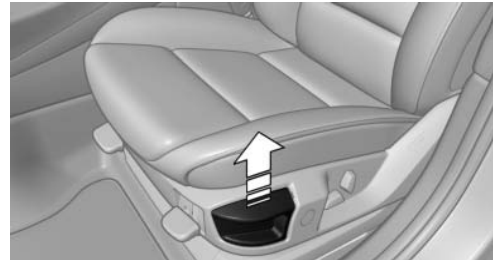

Forward/back:

Pull the lever and slide the seat in the desired direction.

After releasing the lever, move the seat forward or back slightly to make sure it engages properly.

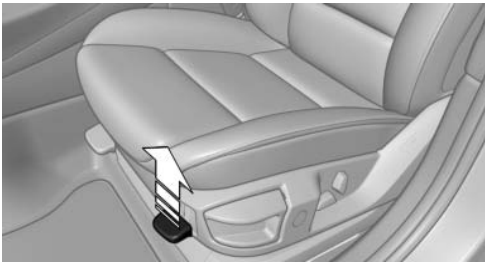

Seat tilt:

Pull the lever and move the seat to the desired tilt. After releasing the lever, apply your weight to the seat or lift it off to make sure the seat engages properly.

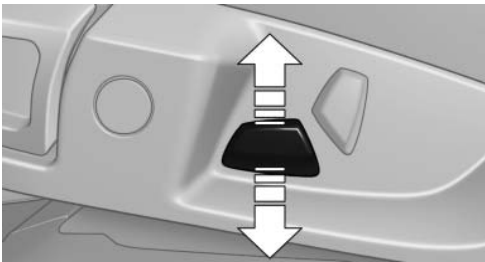

Height:

Move the button in the required direction.

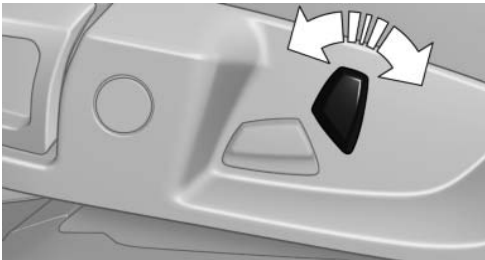

Backrest tilt:

Move the button in the required direction.

## Overview: Power\* seats

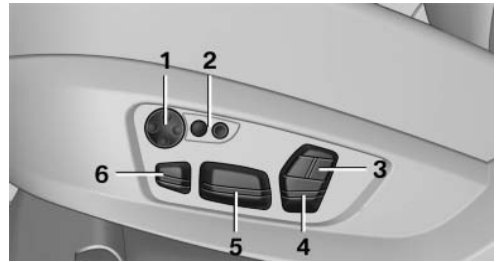

- 1 Lumbar support\*
- 2 Backrest width\*
- 3 Shoulder support\*
- 4 Backrest
- 5 Forward/back, height, tilt
- 6 Thigh support\*

## Adjustments in detail: power\* seats

1. Forward/back.

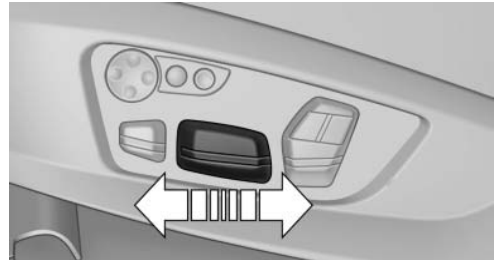

2. Height.

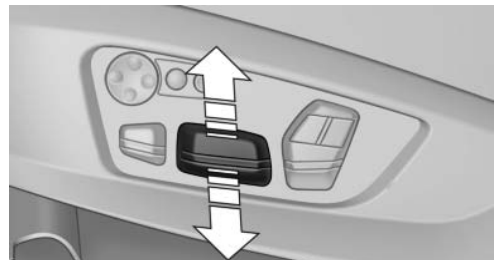

### 3. Seat tilt.

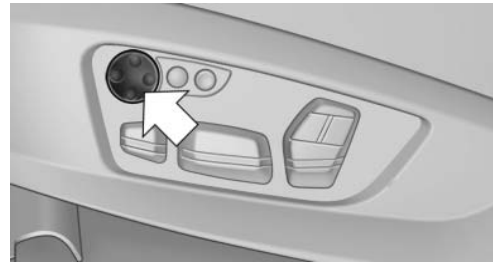
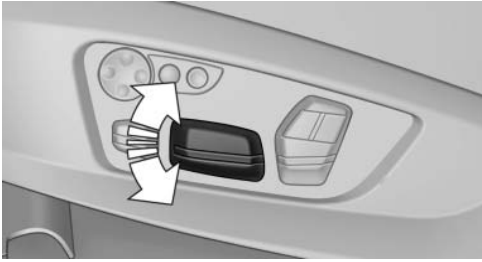

- ▶ Press the front/rear section of the switch. The curvature is increased/decreased.
- ▶ Press the upper/lower section of the switch. The curvature is shifted up/down.

### 4. Backrest tilt.

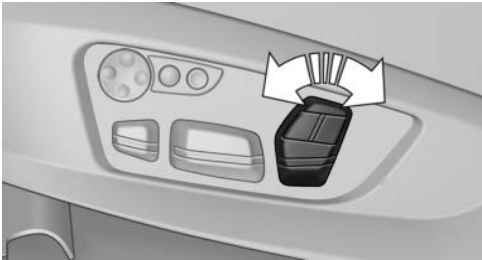

### Backrest width\*

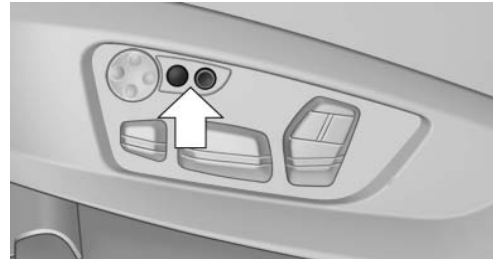

### 5. Thigh support\*.

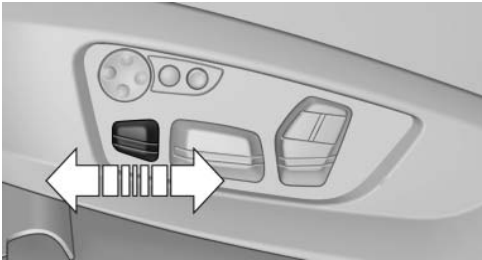

Change the width of the backrest using the side wings to adjust the lateral support.

To make it easier to enter and exit the vehicle, the backrest width temporarily opens fully.

### Lumbar support\*

The curvature of the seat backrest can be adjusted in such a way that it supports the lumbar region of the spine. The lower back and the spine are supported for upright posture.

### Shoulder support\*

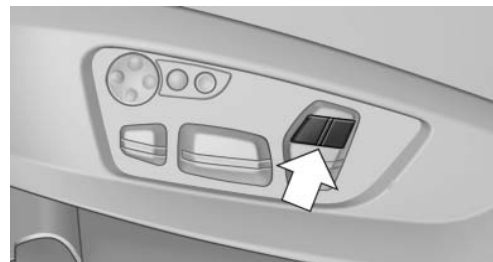

Also supports the back in the shoulder area:

- ▶ Results in a relaxed seating position.
- ▶ Reduces strain on the shoulder muscles.



## Active seat\*

Active adjustment of the seat cushion's contours reduces muscular tension and fatigue to help prevent lower back pain.



Press the button. The LED lights up.

## Front seat heating\*



### Switching on



Press the button once for each temperature level.

The maximum temperature is reached when three LEDs are lit.

### Switching off

Press the button longer.

The LEDs go out.

The temperature may be reduced or seat heating may be switched off entirely to save battery power.

### Temperature distribution\*

The heating action in the seat cushion and backrest can be distributed in different ways.

1. "Climate"
2. "Seat heating distribution"
3. Select the required seat.

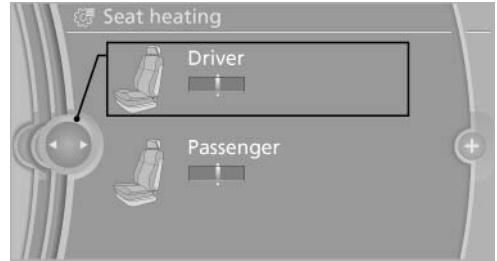

4. Turn the controller to set the temperature distribution.

## Front active seat ventilation\*

The seat cushion and backrest surfaces are cooled by means of integrated fans.

The ventilation rapidly cools the seat, e.g., if the vehicle interior is overheated or for continuous cooling at high temperatures.



### Switching on



Press the button once for each ventilation level.

The highest level is active when three LEDs are lit.

After a short time, the system automatically moves down one level in order to prevent excessive cooling.

### Switching off

Press the button longer.

The LEDs go out.



## Rear seats

### Adjusting

#### Overview: manual seats

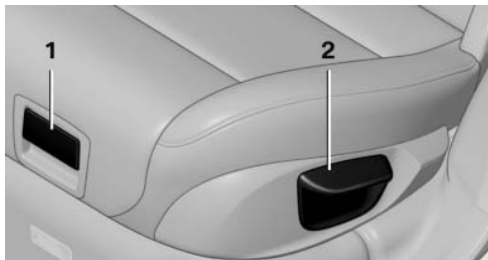

- 1 Forward/backward
- 2 Backrest

#### Settings in detail: manual seats

 Do not adjust the seat while driving. Never attempt to adjust the seat while driving. Otherwise, the restraining effect of the seat can be limited in an accident. ◀



Forward/back:

Pull the lever and slide the seat in the desired direction.

After releasing the lever, move the seat forward or back slightly until it engages.

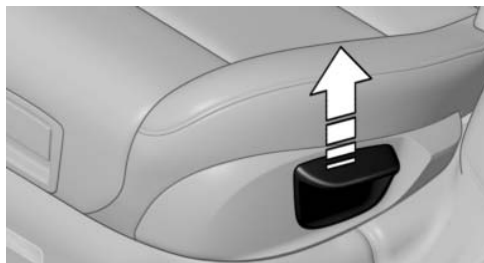

Backrest tilt:

Pull the lever and apply your weight to the backrest or lift it off.

#### Overview: Power\* seats

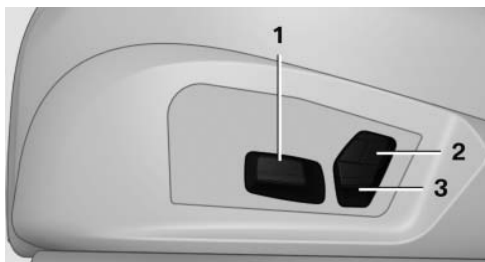

- 1 Forward/backward
- 2 Shoulder support
- 3 Backrest, head restraint

The seats cannot be adjusted if the safety switch for the power windows has been pressed.

#### Settings in detail: Power\* seats

1. Forward/back.

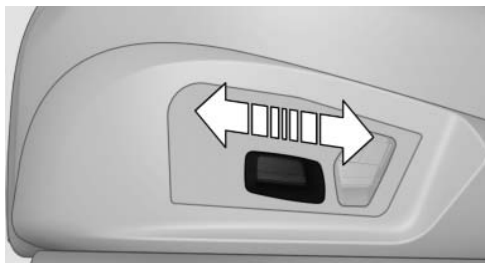

## 2. Backrest tilt.

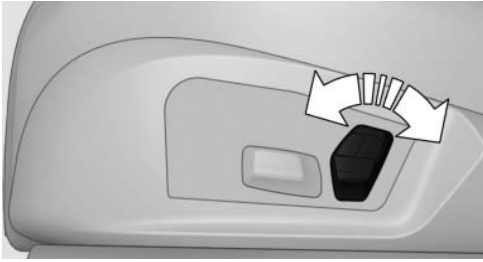

## 3. Head restraint.

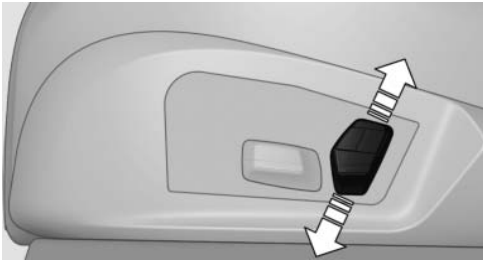

## Shoulder support\*

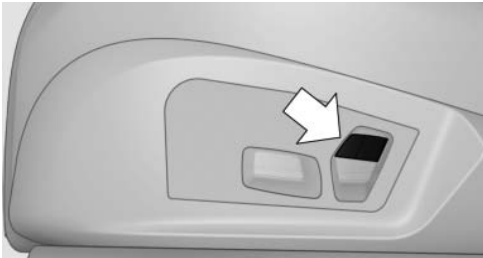

Also supports the back in the shoulder area:

- ▶ Results in a relaxed seating position.
- ▶ Reduces strain on the shoulder muscles.

## Reset\* to standard position



Maintain pressure on the button until the system completes the adjustment.

## Rear seat heating\*



## Switching on



Press the button once for each temperature level.

The maximum temperature is reached when three LEDs are lit.

## Switching off

Press the button longer.

The LEDs go out.

## Temperature distribution\*

The heating action in the seat cushion and backrest can be distributed in different ways.

1. "Climate"
2. "Seat heating rear"

3. Select the required seat.

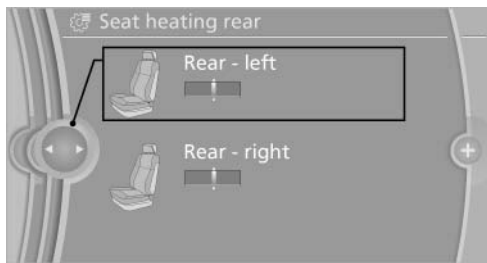

4. Turn the controller to set the temperature distribution.

### Active seat ventilation\*



#### Switching on



Press the button once for each ventilation level.

The highest level is active when three LEDs are lit.

#### Switching off

Press the button longer.

The LEDs go out.

## Safety belts

### Seats with safety belt

The vehicle has four\* or five\* seating positions, each of which is equipped with a safety belt.

### Notes

Always make sure that safety belts are being worn by all occupants before driving away.

Although airbags enhance safety by providing added protection, they are not a substitute for safety belts.

- ▶ The shoulder strap's anchorage point will be correct for adult seat occupants of every build if the seat is correctly adjusted.
- ▶ The two outer safety belt buckles, integrated into the rear seat, are for passengers sitting on the left and right.
- ▶ The center rear seat belt buckle marked with the letters CENTER\* is solely intended for the center passenger.



One person per safety belt

Never allow more than one person to wear a single safety belt. Never allow infants or small children to ride on a passenger's lap. ◀



Putting on the belt

Lay the belt, without twisting, snugly across the lap and shoulders, as close to the body as possible. Make sure that the belt lies low around the hips in the lap area and does not press on the abdomen. Otherwise, the belt can slip over the hips in the lap area in a frontal impact and injure the abdomen.

The safety belt must not lie across the neck, rub on sharp edges, be routed over solid or breakable objects, or be pinched. ◀



Reduction of restraining effect

Avoid wearing clothing that prevents the belt from fitting properly, and pull the shoulder belt periodically to readjust the tension across your lap; otherwise, the retention effect of the safety belt may be reduced. ◀

## Buckling the belt

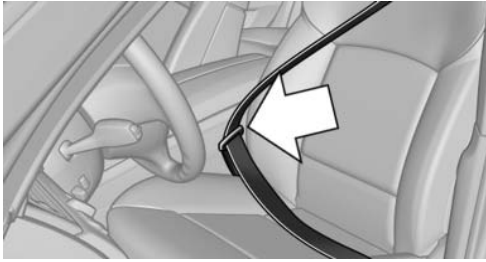

Make sure you hear the latch plate engage in the belt buckle.

## Unbuckling the belt

1. Hold the belt firmly.
2. Press the red button in the belt buckle.
3. Guide the belt back into its reel.

## Safety belt reminder for the driver's and front passenger seat



The indicator lamp flashes or lights up and a signal sounds. Make sure that the safety belts are positioned correctly.

The safety belt reminder is active at speeds above approx. 5 mph/8 km/h. It can also be activated if objects are placed on the front passenger seat.

## Damage to safety belts

In the case of strain caused by accidents or damage:

Have the safety belts, including the safety belt tensioners, replaced and have the belt anchors checked.



Checking and replacing safety belts

Have the work performed only by your service center; otherwise, it cannot be ensured that this safety feature will function properly. ◀

## Front head restraints

### Correctly adjusted head restraint

A correctly adjusted head restraint reduces the risk of injury to cervical vertebrae in the event of an accident.



Adjusting the head restraint

Correctly adjust the head restraints of all occupied seats; otherwise, there is an increased risk of injury in an accident. ◀

### Height

Adjust the head restraint so that its center is approximately at ear level.

### Distance

Adjust the distance so that the head restraint is as close as possible to the back of the head.

### Active head restraint

In the event of a rear-end collision with a certain severity, the active head restraint automatically reduces the distance from the head.



Reduced protective function

- ▶ Do not use seat or head restraint covers.
- ▶ Do not hang objects, e.g., clothes hangers, on the head restraints.
- ▶ Only attach accessories approved by BMW to the seat or head restraint.

Otherwise, the protective function of the active head restraint will be impaired and the personal safety of the occupants will be endangered. ◀

## Adjusting the height: manual head restraints

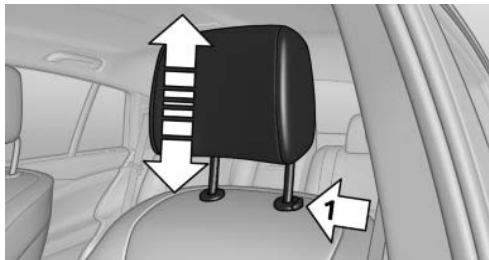

- ▷ To raise: pull.
- ▷ To lower: press the button, arrow 1, and push the head restraint down.

## Adjusting the height: Electrical\* head restraints

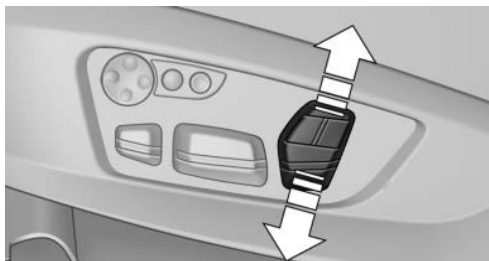

Adjusting electrically.

## Distance to back of head: manual head restraints

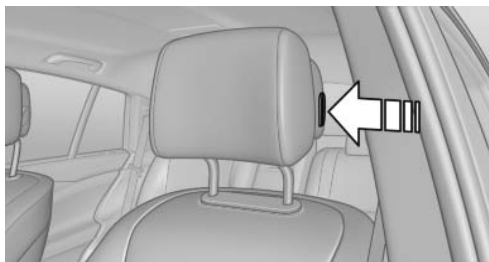

- ▷ Forward: pull.
- ▷ Back: press the button and push the head restraint toward the rear.

## Distance to the back of the head: power\* head restraints

The head restraint is automatically repositioned when the shoulder support is adjusted.

## Adjusting the side extensions\*

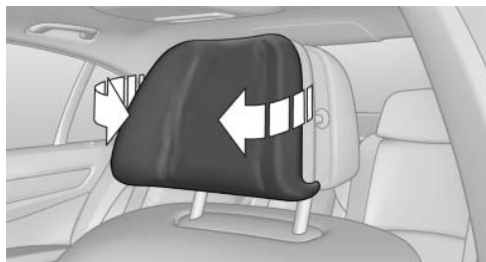

Fold forward for increased lateral support in the resting position.

## Removing

The head restraints cannot be removed.

## Rear head restraints

### Correctly adjusted head restraint

A correctly adjusted head restraint reduces the risk of injury to cervical vertebrae in the event of an accident.

- ⚠ Adjusting the head restraint
- Correctly adjust the head restraints of all occupied seats; otherwise, there is an increased risk of injury in an accident. ◀

### Height

Adjust the head restraint so that its center is approximately at ear level.

### Distance

Adjust the distance so that the head restraint is as close as possible to the back of the head.

## Adjusting the height: manual head restraints

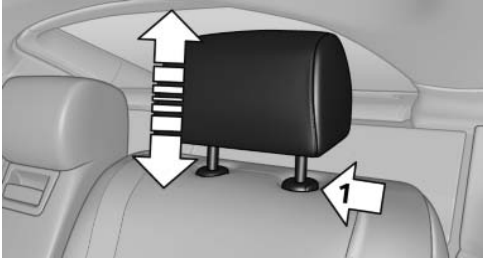

- ▷ To raise: pull.
- ▷ To lower: press the button, arrow 1, and push the head restraint down.

## Adjusting the height: Electrical\* head restraints

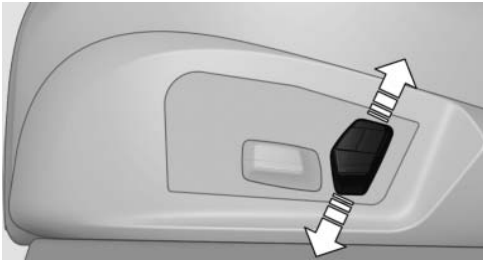

Move the switch in the desired direction.

## Adjusting the side extensions\*

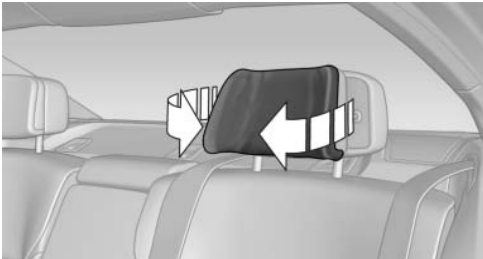

Fold the side extensions on the head restraint forward for increased lateral support in the resting position.

## Removing: manual head restraints

Only remove the head restraint if no one will be sitting in the seat in question.

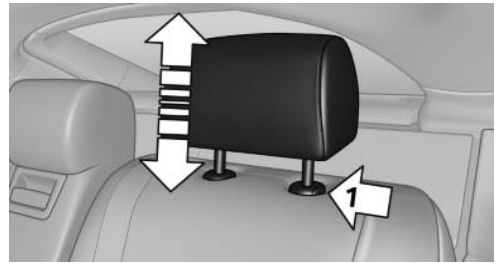

1. Pull the head restraint upward as far as possible.
2. Press the button, arrow 1, and pull the head restraint out completely.



Before transporting passengers  
Reinstall the head restraint before transporting anyone in the seat; otherwise, the protective function of the head restraint is unavailable. ◀

## Removing: power\* head restraints

For technical reasons, the head restraint cannot be removed.

## Seat, mirror, and steering wheel memory\*

### General information

#### Front



Two different driver's seat, exterior mirror, and steering wheel positions can be stored and retrieved for each remote control. The adjustment of the lumbar support is not stored.

## Rear



Two different seat positions can be stored and retrieved.

## Storing

1. Switch on the ignition.
2. Set the desired position.
3.  Press the button. The LED in the button lights up.
4. Press the desired button 1 or 2. The LED goes out.

If the M button is pressed accidentally:

-  Press the button again.  
The LED goes out.

## Calling up settings

 Do not retrieve the memory while driving  
Do not retrieve the memory setting while driving, as an unexpected movement of the seat or steering wheel could result in an accident. ◀

## Comfort function

1. Open the driver's door.
2. Switch off the ignition.
3. Briefly press the desired button 1 or 2.

The corresponding seat position is performed automatically.

The procedure stops when a switch for adjusting the seat or one of the buttons is pressed.

## Safety mode

1. Close the driver's door or switch on the ignition.

2. Press and hold the desired button 1 or 2 until the adjustment procedure is completed.

## Calling up of a seat position deactivated

After a brief period, the calling up of stored seat positions is deactivated to save battery power.

To reactivate calling up of a seat position:

- ▶ Open or close the door or tailgate.
- ▶ Press a button on the remote control.
- ▶ Press the Start/Stop button.

## Mirrors

### Exterior mirrors

#### At a glance

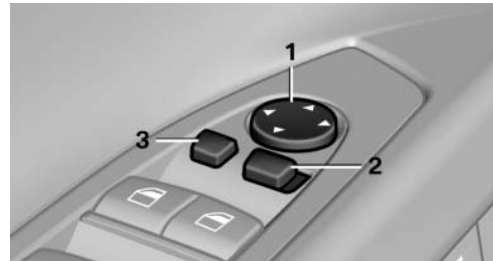

- 1 Adjusting
- 2 Left/right, Automatic Curb Monitor\*
- 3 Fold in and out\*

### General information

The mirror on the passenger side is more curved than the driver's side mirror.

 Estimating distances correctly  
Objects reflected in the mirror are closer than they appear. Do not estimate the distance to the traffic behind you based on what you see in the mirror, as this will increase your risk of an accident. ◀

The mirror setting is stored for the remote control currently in use. When the vehicle is unlocked via the remote control, the position is au-

tomatically retrieved if the setting for this function is active.

## Selecting a mirror

 To change over to the other mirror:  
Slide the mirror changeover switch.

## Adjusting electrically

 The setting corresponds to the direction in which the button is pressed.

## Storing positions\*

Seat, mirror, and steering wheel memory, refer to page 58.

## Adjusting manually

If an electrical malfunction occurs, for example, press the edges of the mirror glass.

## Automatic Curb Monitor\*

When the reverse gear is engaged, the mirror glass tilts downward slightly on the front passenger side. This improves your view of the curb and other low-lying obstacles when parking, for example.

## Activating

-  Slide the mirror changeover switch to the driver's side mirror position.
- Engage transmission position R.

## Deactivating

Slide the mirror changeover switch to the passenger's side mirror position.

## Fold in and out\*

 Press the button.

Possible up to approx. 15 mph/20 km/h.

For example, this is advantageous

- ▷ In car washes.
- ▷ In narrow streets.

- ▷ For folding back mirrors that were folded away manually.

Mirrors that were folded in are folded out automatically at a speed of approx. 25 mph/40 km/h.

 Fold in the mirror in a car wash  
Before entering an automatic car wash, fold in the exterior mirrors by hand or with the button; otherwise, they could be damaged, depending on the width of the vehicle. ◀

## Automatic heating

Both exterior mirrors are automatically heated whenever the engine is running.

## Automatic dimming feature

Both exterior mirrors are automatically dimmed. Photocells are used for control in the Interior rear view mirror, refer to page 61.

## Interior rearview mirror

### Reducing the blinding effect

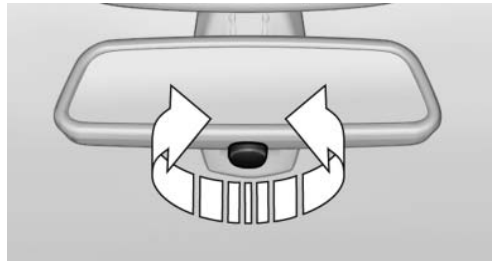

From behind when driving at night: turn the knob.



## Interior rearview mirror, automatic dimming feature\*

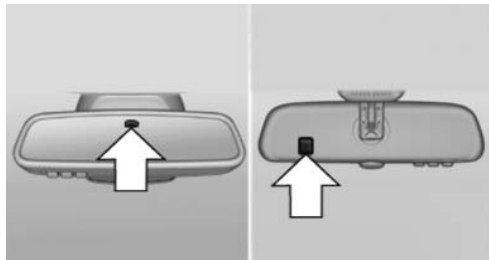

Photocells are used for control:

- ▷ In the mirror glass.
- ▷ On the back of the mirror.

For proper operation:

- ▷ Keep the photocells clean.
- ▷ Do not cover the area between the inside rearview mirror and the windshield.

## Steering wheel

### General information



Do not adjust while driving

Do not adjust the steering wheel while driving; otherwise, an unexpected movement could result in an accident. ◀

### Manual steering wheel adjustment

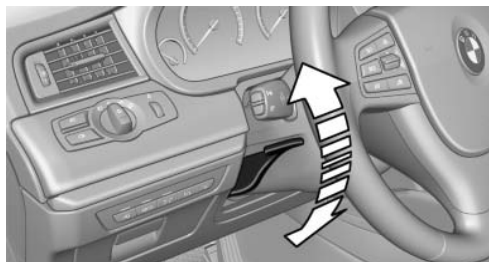

1. Fold the lever down.
2. Move the steering wheel to the preferred height and angle to suit your seating position.
3. Fold the lever back.

## Power\* steering wheel adjustment

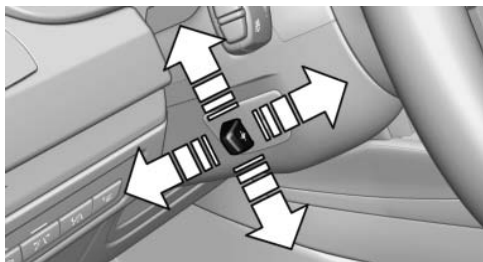

The steering wheel can be adjusted in four directions.

### Storing the position

Seat, mirror, and steering wheel memory, refer to page 58.

### Steering wheel heating\*

#### Switching on/off



Press the button.

- ▷ On: the LED lights up.
- ▷ Off: the LED goes out.

# Transporting children safely

## The right place for children

### Note



Children in the vehicle

Do not leave children unattended in the vehicle; otherwise, they could endanger themselves and other persons, e.g., by opening the doors. ◀

### Children should always be in the rear

Accident research shows that the safest place for children is in the back seat.



Transporting children in the rear

Only transport children younger than 13 years of age or shorter than 5 ft/150 cm in the rear in child restraint fixing systems provided in accordance with the age, weight and size of the child; otherwise, there is an increased risk of injury in an accident.

Children 13 years of age or older must wear a safety belt as soon as a suitable child restraint fixing system can no longer be used, due to their age, weight and size. ◀

### Children on the front passenger seat

Should it ever be necessary to use a child restraint fixing system in the front passenger seat, make sure that the front, knee and side airbags on the front passenger side are deactivated. Automatic deactivation of front passenger airbags, refer to page 90.



Deactivating the front passenger airbags

If a child restraint fixing system is used in the front passenger seat, the front passenger airbags must be deactivated; otherwise, there is an increased risk of injury to the child when the airbags are triggered, even with a child restraint fixing system. ◀

## Installing child restraint fixing systems

### Before mounting

If the rear seat backrests are adjustable:

Before mounting child restraint fixing systems, return all of the rear seat backrests to the basic position.

### Notes



Manufacturer's information for child restraint fixing systems

To select, mount and use child restraint fixing systems, observe the information provided by the system manufacturer; otherwise, the protective effect can be impaired. ◀

### On the front passenger seat

After installing a child restraint fixing system in the front passenger seat, make sure that the front, knee and side airbags on the front passenger side are deactivated.

Deactivate the front passenger airbags automatically, refer to page 90.



Deactivating the front passenger airbags

If a child restraint fixing system is used in the front passenger seat, the front passenger airbags must be deactivated; otherwise, there is an increased risk of injury to the child when the airbags are triggered, even with a child restraint fixing system. ◀

### Seat position and height

Before installing a child restraint fixing system, move the front passenger seat as far back as possible and adjust its height to the middle position to obtain the best possible position for the belt and to offer optimal protection in the event of an accident.

Do not change the seat position and height after this.

## Backrest width\*

Before installing a child restraint fixing system in the front passenger seat, open the backrest width completely. Do not change the backrest width again and do not call up a memory position.

 Backrest width for the child seat  
Before installing a child restraint fixing system in the front passenger seat, the backrest width must be opened completely. Do not change the adjustment after this; otherwise, the stability of the child seat will be reduced. ◀

## Child seat security



The rear safety belts and the front passenger safety belt can be locked against pulling out for mounting the child restraint fixing systems.

## Locking the safety belt

1. Pull out the belt webbing completely.
2. Secure the child restraint fixing system with the belt.
3. Allow the belt webbing to be pulled in and pull it taut against the child restraint fixing system. The safety belt is locked.

## Unlocking the safety belt

1. Unbuckle the belt buckle.
2. Remove the child restraint fixing system.
3. Allow the belt webbing to be pulled in completely.

## LATCH child restraint fixing system

LATCH: Lower Anchors and Tether for Children.

### Note

 Manufacturer's information for LATCH child restraint fixing systems

To mount and use the LATCH child restraint fixing systems, observe the operating and safety information from the system manufacturer; otherwise, the level of protection may be reduced. ◀

## Mounts for the lower LATCH anchors

 Correctly engage the lower LATCH anchors

Make sure that the lower LATCH anchors have properly engaged and that the child restraint fixing system is resting snugly against the backrest; otherwise, the degree of protection offered may be reduced. ◀

Before mounting the LATCH child restraint fixing system, pull the belt away from the child restraint fixing system.

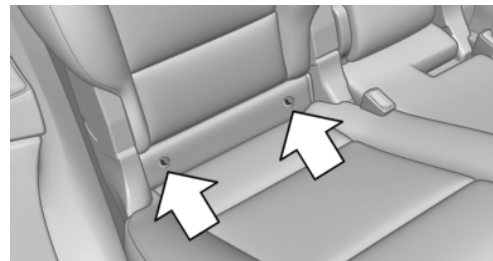

Mounts for the lower LATCH anchors are located behind the seat cover between the backrest and the seat cushion at the marked locations.

## Exposing the lower LATCH anchors

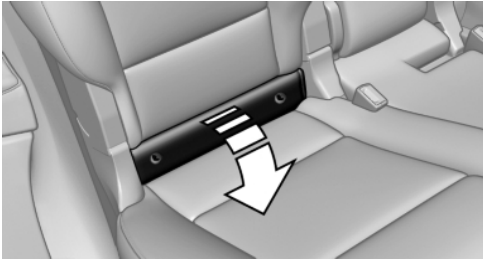

1. Reach between the seat cushion and the backrest.
2. Detach the seat cover from the Velcro® fastener.
3. Pull the seat cover forward.

## Mounting LATCH child restraint fixing systems

1. Move the seat to its rearmost position.
2. For better accessibility, tilt the backrest back slightly.
3. Fold the leather cover on the seat forward.
4. Mount the child restraint fixing system; refer to the operating instructions of the system.
5. Make sure that both lower LATCH anchors have properly engaged and that the child restraint fixing system is resting snugly against the backrest.
6. After mounting the system, move the backrest back up slightly so that the child restraint fixing system rests against the backrest.

## Mounting LATCH child restraint fixing systems on power rear seats\*

1. Before mounting, adjust the seats to their basic position, refer to page 54.
2. Mount the child restraint fixing system; refer to the operating instructions of the system.
3. Ensure that both LATCH anchors are properly connected.

## Child restraint fixing system with a tether strap

### Mounting points

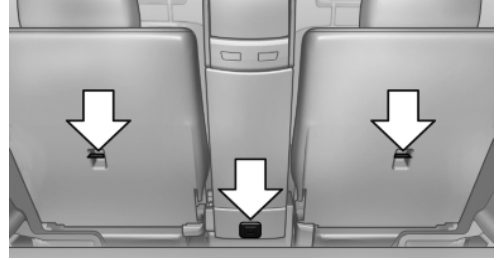

Depending on the vehicle equipment, there are two outer or three mounting points for child restraint fixing systems with a tether strap.

Fold up the middle mounting point.



### LATCH mounting eyes

Only use the mounting eyes for the upper LATCH retaining strap to secure child restraint fixing systems; otherwise, the mounting eyes could be damaged. ◀

### Retaining strap guide



### Retaining strap

Make sure that the upper retaining strap is not routed over the head restraints or sharp edges and is free of twisting on its way to the upper mounting point; otherwise, the belt cannot properly secure the child restraint fixing system in an accident. ◀

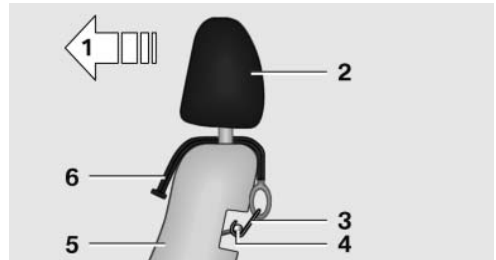

- 1 Direction of travel
- 2 Head restraint.
- 3 Hook for upper retaining strap

- 4 Mounting point/eye
- 5 Seat backrest
- 6 Upper retaining strap

### Attaching the upper retaining strap to the mounting point

1. Raise the head restraint.
2. Guide the upper retaining strap between the supports of the head restraint.
3. Attach the hooks of the retaining strap to the mounting eyes.
4. Tighten the retaining strap by pulling it down.
5. Lower the head restraint.

## Locking the doors and windows

### Rear doors

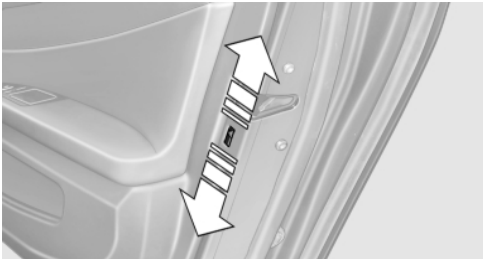

Push the locking lever on the rear doors down. The door can now be opened from the outside only.

### Safety switch for the rear



Press the button on the driver's door if children are being transported in the rear.

This locks various functions so that they cannot be operated from the rear: safety switch, refer to page 46.

# Driving

## Start/Stop button

### The concept



Pressing the Start/Stop button switches the ignition on or off and starts the engine.

The engine starts if the brake pedal is pressed when you press the Start/Stop button.

### Ignition on

Press the Start/Stop button, and do not press on the brake pedal at the same time.

All vehicle systems are ready for operation.

Most of the indicator and warning lamps in the instrument cluster light up for varying lengths of time.

To save battery power when the engine is off, switch off the ignition and any unnecessary electronic systems/power consumers.

The ignition switches off automatically:

- ▷ When the vehicle is locked, if the low beams are switched on.
- ▷ Shortly before the battery is discharged completely, so that the engine can still be started.
- ▷ If the engine is switched off and the ignition is switched on, the system automatically switches to the radio ready state when the door is opened if the lights are switched off or the daytime running lights are switched on.

### Ignition off

Press the Start/Stop button again, and do not press on the brake pedal at the same time.

All indicator lamps in the instrument cluster go out.

To save battery power when the engine is off, switch off the ignition and any unnecessary electronic systems/power consumers.



Transmission position P with the ignition off

When the ignition is switched off, position P is engaged automatically. When in an automatic car wash, for example, ensure that the ignition is not switched off accidentally. ◀

When the vehicle is locked using the central locking system, the ignition switches off automatically.

### Radio ready state

Activate radio ready state:

- ▷ When the ignition is switched off: press ON/OFF button on the radio.
- ▷ When the engine is running: press START/STOP button.

Some electronic systems/power consumers remain ready for operation.

Radio ready state switches off automatically:

- ▷ After approx. 8 minutes.
- ▷ When the vehicle is locked using the central locking system.

## Starting the engine

### General information



Enclosed areas

Do not let the engine run in enclosed areas; otherwise, breathing of exhaust fumes may lead to loss of consciousness and death. The exhaust gases contain carbon monoxide, an odorless and colorless but highly toxic gas. ◀



Unattended vehicle

Do not leave the car unattended with the engine running; otherwise, it presents a potential source of danger.

Before leaving the car with the engine running, set the parking brake and place the transmission in position P or neutral to prevent the car from moving. ◀



Frequent starting in quick succession

Avoid repeated futile attempts at starting the car and avoid starting the car frequently in quick succession. Otherwise, the fuel is not burned or is inadequately burned, and there is the danger of overheating and damaging the catalytic converter. ◀

Do not wait for the engine to warm up while the vehicle remains stationary. Start driving at moderate engine speeds.

## Starting the engine



Press on the brake pedal and press the Start/Stop button.

The engine is cranked until it starts.

## Engine stop

### General information



Take the remote control with you

Take the remote control with you when leaving the vehicle so that children, for example, cannot operate the windows and injure themselves. ◀



Set the parking brake and further secure the vehicle as required

Set the parking brake firmly when parking; otherwise, the vehicle could roll. On steep upward and downward inclines, further secure the vehicle, for example, by turning the steering wheel in the direction of the curb. ◀

### Before driving into a car wash

In order for the vehicle to be able to roll into a car wash, heed the information regarding Washing in automatic car washes, refer to page 269.

## Switching off the engine

- Engage transmission position P with the vehicle stopped.
- Press the Start/Stop button.  
The engine is switched off.  
The radio ready state is switched on.
- Set the parking brake.

## Parking brake

### The concept

The parking brake is used to prevent the vehicle from rolling when it is parked.

- Engine switched off: the parking brake acts on the rear wheels.
- Engine running: the parking brake acts on the disc brakes of the front and rear wheels via the hydraulic brake system.

The parking brake can be set manually or automatically:

- Manual: by pulling and pushing the switch.
- Automatic: by activating Automatic Hold.



### Setting



Pull the switch.

The LED lights up.



The indicator lamp lights up in red. The parking brake is set.



Lower lamp: indicator lamp in Canadian models



**⚠** Set the parking brake and further secure the vehicle as required

Set the parking brake firmly when parking; otherwise, the vehicle could roll. On steep upward and downward inclines, further secure the vehicle, for example, by turning the steering wheel in the direction of the curb. ◀

## While driving

Use while driving:

Pull the switch and hold it. The vehicle brakes hard while the button is being pulled.

**PARK** The indicator lamp lights up in red, a signal sounds and the brake lamps light up.

**(P)** Lower lamp: indicator lamp in Canadian models

If the vehicle is braked to a speed of approx. 2 mph/3 km/h, the parking brake remains set.

## Releasing

**(P)** Press the switch while the brake pedal is pressed or transmission position P is engaged.

The LED and indicator lamp go out.

The parking brake is released.

**⚠** Take the remote control with you  
 Take the remote control with you when leaving the vehicle so that children, for example, cannot release the parking brake. ◀

## Manual release

The parking brake can be released manually in the event of a power failure or electrical fault.

**⚠** Before releasing, secure the vehicle against rolling

Before releasing the parking brake manually, and whenever you park the vehicle with the parking brake released, ensure that position P of the automatic transmission is engaged.

Secure the vehicle in a manner appropriate to the inclination of the road, e.g., with a wheel chock; otherwise, there is the danger of the vehicle rolling. ◀

## Unlocking

1. Raise the rear cargo floor cover in the cargo area, arrow 1, and fasten it with a retaining strap.

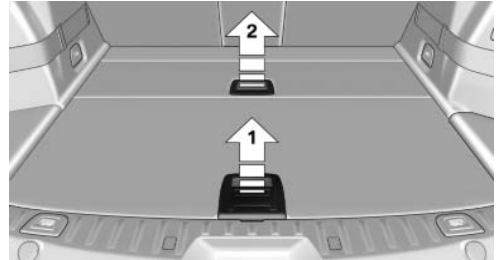

2. Remove the release tool from the tool kit.

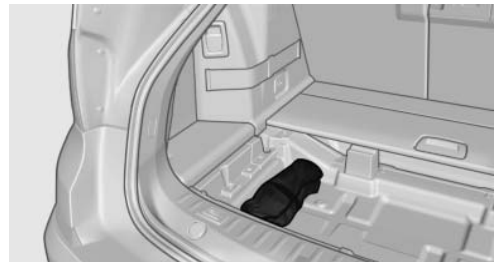

3. Take out the floor trim in the cargo area, removing the clips with a screwdriver, arrows.

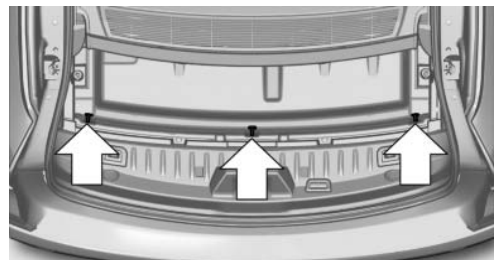



- Hook the release tool into the release point, arrow.

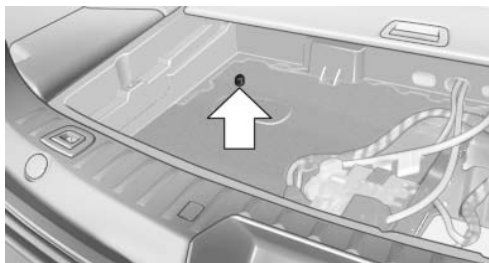

- Forcefully pull the release tool up against the resistance until you notice a marked increase in the resistance and the parking brake releases audibly.

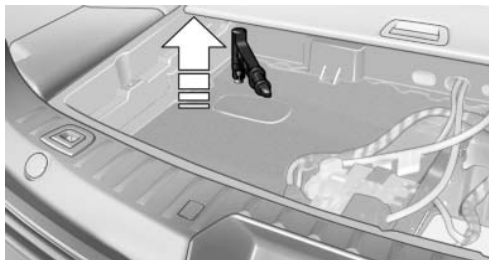

**!** Have the malfunction corrected  
If the parking brake has been released manually in response to a malfunction, only technicians can return it to operation.  
Have the malfunction corrected by your service center. ◀

### After a power failure

**!** Only put the parking brake into operation after a power failure  
The parking brake should only be put into operation again if it was manually released due to an interruption in the supply of electrical power. Otherwise, it cannot be ensured that the parking brake will function properly. ◀

### Putting the parking brake into operation

- Switch on the ignition.

- (P)** Press the switch while the brake is depressed or transmission position P is engaged.

It may take several seconds for the brake to be put into operation. Any sounds associated with this are normal.

**PARK** The indicator lamp in the instrument cluster goes out as soon as the parking brake is ready for operation.

**(P)** Lower lamp: indicator lamp in Canadian models.

## Automatic Hold

### The concept

This system assists the driver by automatically setting and releasing the brake, such as when moving in stop-and-go traffic.

The vehicle is automatically held in place when it is stationary.

On inclines, the system prevents the vehicle from rolling backward when driving away.



### For your safety

Under the following conditions, Automatic Hold is automatically deactivated and the parking brake is set:

- ▶ The engine is switched off.
- ▶ A door is opened and driver's safety belt is unbuckled.
- ▶ The moving vehicle is brought to a standstill using the parking brake.

**PARK**



The indicator lamp switches from green to red and the letters AUTO H go out.

Lower lamp: indicator lamp in Canadian models

Before driving away:

- ▶ Release the parking brake manually.
- ▶ Reactivate Automatic Hold.



Leaving the vehicle with the engine running

Before leaving the vehicle with the engine running, engage position P of the automatic transmission and ensure that the parking brake is set. Otherwise, the vehicle may begin to roll. ◀

## Activating

This function can be activated when the driver's door is closed and the safety belt is fastened, or while driving.



Press the button.

The LED and the letters AUTO H light up.



The indicator lamp lights up.  
Automatic Hold is activated.

## Deactivating



Press the button again.

The LED and the letters AUTO H go out.

Automatic Hold is deactivated.

If the vehicle is being held by Automatic Hold, press on the brake pedal to deactivate it.

When the parking brake, refer to page 67, is set manually, Automatic Hold is deactivated automatically.

## Driving

Automatic Hold is activated: the vehicle is automatically secured against rolling when it stops.



The indicator lamp lights up in green.

Step on the accelerator pedal to drive off.

The brake is released automatically.

The indicator lamp goes out.

Lower lamp: indicator lamp in Canadian models



Before driving into a car wash

Deactivate Automatic Hold; otherwise, the parking brake will be set when the vehicle is stationary and the vehicle will no longer be able to roll. ◀

## Parking

The parking brake is automatically set if the engine is switched off while the vehicle is being held by Automatic Hold.

Automatic Hold remains activated during an engine stop brought about by the Automatic Engine Start/Stop Function\*.



The indicator lamp changes from green to red.

The parking brake is not set if the engine is switched off while the vehicle is coasting to a halt. Automatic Hold is deactivated.

Lower lamp: indicator lamp in Canadian models



Take the remote control with you

Take the remote control with you when leaving the vehicle so that children, for example, cannot release the parking brake. ◀

## Malfunction

In the event of a failure or malfunction of the parking brake, secure the vehicle against rolling using a wheel chock, for example, when leaving it.

# Turn signal, high beams, headlamp flasher

## Turn signal

### Using turn signals

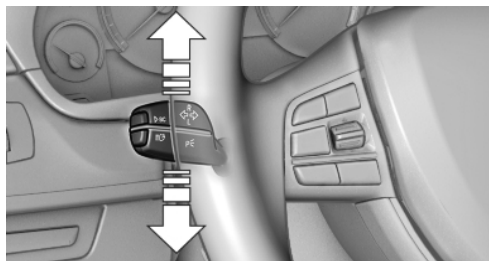

Press the lever beyond the resistance point.

To switch off manually, press the lever to the resistance point.

Unusually rapid flashing of the indicator lamp indicates that a turn signal bulb has failed.

### Triple turn signal activation

Press the lever to the resistance point.

The turn signal flashes three times.

The function can be activated or deactivated:

1. "Settings"
2. "Lighting"
3. "Triple turn signal"

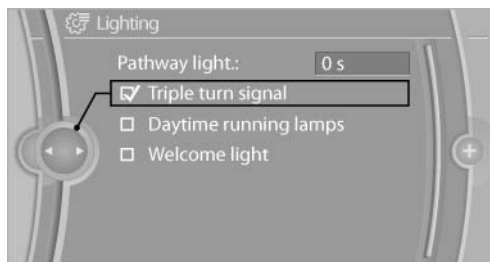

### Signaling briefly

Press the lever to the resistance point and hold it there for as long as you want the turn signal to flash.

## High beams, headlamp flasher

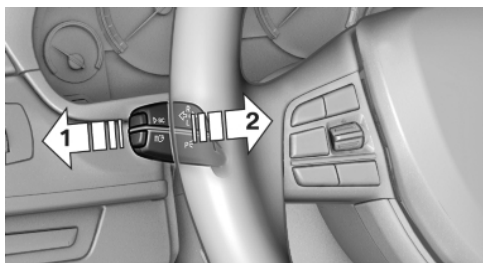

- High beams, arrow 1.
- Headlamp flasher, arrow 2.

## Washer/wiper system

### Switching the wipers on/off and brief wipe



Do not switch on the wipers if frozen

Do not switch on the wipers if they are frozen onto the windshield; otherwise, the wiper blades and the windshield wiper motor may be damaged. ◀

### Switching on

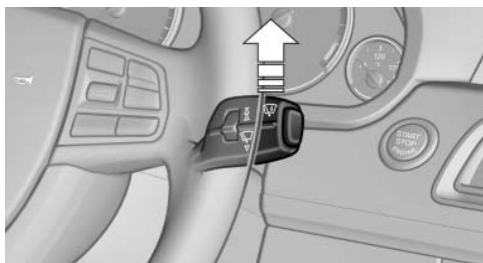

Press the wiper levers up.

The lever automatically returns to its initial position when released.

- Normal wiping speed: press up once.  
The wipers switch to intermittent operation when the vehicle is stationary.
- Fast wiping speed: press up twice or press once beyond the resistance point.  
The wipers switch to normal speed when the vehicle is stationary.

## Switching off and brief wipe

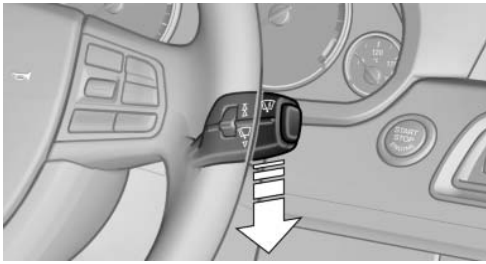

Press the wiper levers down.

The lever automatically returns to its initial position when released.

- ▷ Brief wipe: press down once.
- ▷ To switch off normal wipe: press down once.
- ▷ To switch off fast wipe: press down twice.

## Rain sensor

### The concept

The time between wipes is controlled automatically and depends on the intensity of the rainfall.

The sensor is located on the windshield, directly in front of the interior rearview mirror.

### Activating/deactivating the rain sensor

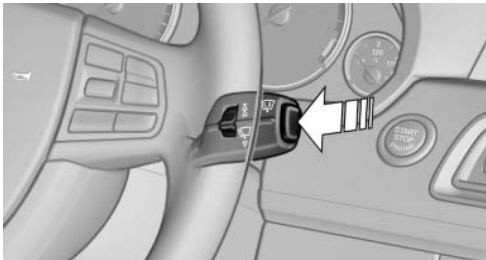

Press the button on the wiper lever.

When activated, the wipers move over the windshield once.

The LED in the steering column stalk lights up.



Deactivate the rain sensor in car washes

Deactivate the rain sensor when passing through an automatic car wash; otherwise, damage could be caused by undesired wiper activation. ◀

## Rain sensor sensitivity

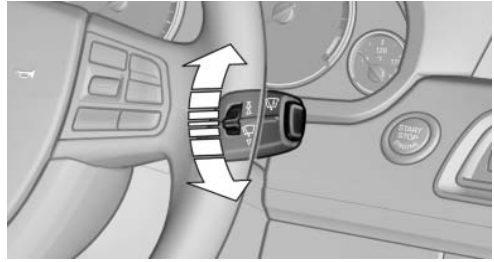

Turn the thumbwheel.

## Clean the windshield, headlamps\*

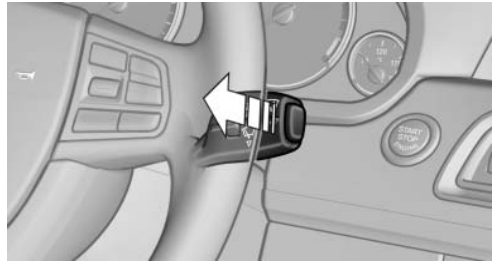

Pull the lever.

The system sprays washer fluid on the windshield and activates the wipers briefly.

In addition, the headlamps are cleaned at regular intervals when the vehicle lights are switched on.



Do not use the washer system at freezing temperatures

Do not use the washers if there is any danger that the fluid will freeze on the windshield; otherwise, your vision could be obscured. For this reason, use antifreeze.

Avoid using the washer when the reservoir is empty; otherwise, you could damage the pump. ◀

## Windshield washer nozzles

The washer jets are automatically heated\* whenever the ignition is switched on.

### Fold-out position of the wipers

Required when changing the wiper blades or under frosty conditions, for example.

1. Switch off the ignition.
2. Under frosty conditions, ensure that the wiper blades are not frozen onto the windshield.
3. Press the wiper lever up beyond the point of resistance and hold it for approx. 3 seconds, until the wiper remains in a nearly vertical position.

After the wipers are folded back down, the wiper system must be reactivated.

 Fold the wipers back down  
Before switching the ignition on, fold the wipers back down to the windshield; otherwise, the wipers may become damaged when they are switched on. ◀

1. Switch on the ignition.
2. Press the wiper levers down. The wipers move to their resting position and are ready for operation.

## Washer fluid

### General information

 Antifreeze for washer fluid  
Antifreeze is flammable. Therefore, keep it away from sources of ignition.

Only keep it in the closed original container and inaccessible to children.

Follow the instructions on the container. ◀

## Washer fluid reservoir

 Adding washer fluid  
Only add washer fluid when the engine is cool, and then close the cover completely to avoid contact between the washer fluid and hot engine parts.

Otherwise, there is the danger of fire and a risk to personal safety if the fluid is spilled. ◀

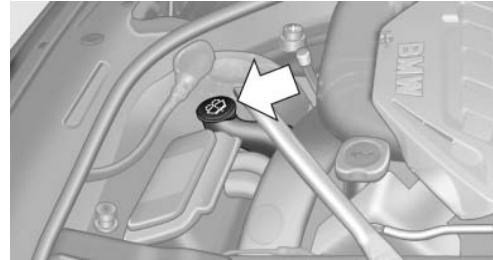

All washer nozzles are supplied from one reservoir.

Fill with water and – if required – with a washer antifreeze, according to the manufacturer's recommendations.

Mix the washer fluid before adding to maintain the correct mixing ratio.

### Capacity

Approx. 5.3 US quarts/ 5 liters

## Automatic transmission with Steptronic

### Transmission positions

#### D Drive, automatic position

Position for normal vehicle operation. All forward gears are available.

#### R is Reverse

Select only when the vehicle is stationary.

#### N is Neutral

Use in automatic car washes, for example. The vehicle can roll.

When the ignition is switched off, refer to page 66, position P is engaged automatically.

## P Park

Select only when the vehicle is stationary. The drive wheels are blocked.

P is engaged automatically:

- ▷ After the engine is switched off, if the car is in radio ready state, refer to page 66, or if the ignition is switched off, refer to page 66, and if position R or D is engaged.
- ▷ If the ignition is switched off and position N is engaged.
- ▷ If the safety belt is unbuckled, the driver's door is opened, and the brake pedal is not pressed while the vehicle is stationary and transmission position R or D is engaged.

## Kickdown

Kickdown is used to achieve maximum driving performance. Press on the accelerator beyond the resistance point at the full throttle position.

## Engaging the transmission position

- ▷ Transmission position P can only be disengaged if the engine is running and the brake pedal is pressed.
- ▷ With the vehicle stationary, press on the brake pedal before shifting out of P or N; otherwise, the shift command will not be executed: shift lock.

 Depress the brake until you start driving

To prevent the vehicle from creeping after you select a driving position, maintain pressure on the brake pedal until you are ready to start. ◀

## Engaging D, R and N

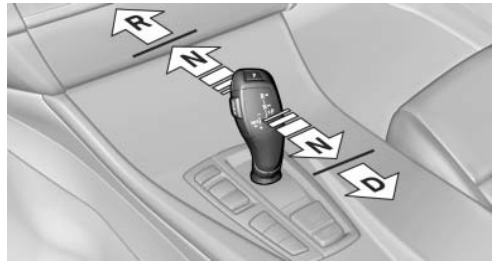

Briefly push the selector lever in the desired direction, beyond a resistance point if necessary. After releasing the selector lever, it returns to its center position.



Press the Unlock button to:

- ▷ Engage R.
- ▷ Shift out of P.

## Engaging P



Press button P.

## Sport program and manual mode M/S

### Activating the sport program



Push the selector lever to the left out of transmission position D.

DS is displayed in the instrument cluster.

This position is recommended for a performance-oriented driving style.

### Activating the M/S manual mode

Push the selector lever to the left out of transmission position D.

Push the selector lever forward or backward.

Manual mode becomes active and the gear is changed.

The engaged gear is displayed in the instrument cluster, e.g., M1.

- ▶ To shift down: press the selector lever forward.
- ▶ To shift up: press the selector lever backward.

The transmission only shifts up or down if the rpm and vehicle speed are appropriate. If the engine speed is too high, the transmission does not shift down.

The selected gear is briefly displayed in the instrument cluster, followed by the current gear.

### Ending the sport program/manual mode

Push the selector lever to the right.

D is displayed in the instrument cluster.

## Displays in the instrument cluster



The transmission position is displayed, for instance, P.



## Displays

### Instrument cluster

#### At a glance

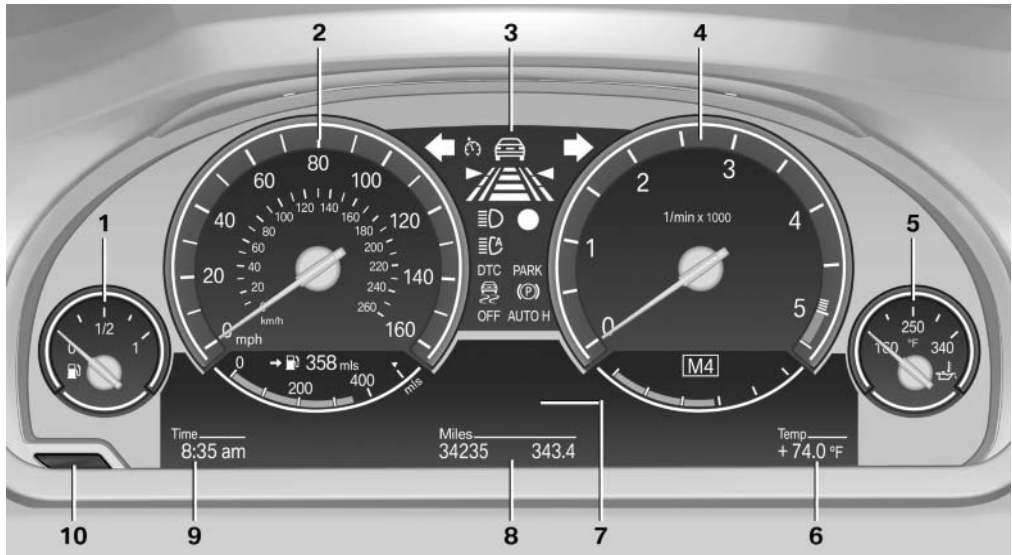

- |                           |                         |
|---------------------------|-------------------------|
| 1 Fuel gauge              | 6 External temperature* |
| 2 Speedometer             | 7 Electronic displays   |
| 3 Indicator/warning lamps | 8 Miles, trip miles     |
| 4 Tachometer              | 9 Clock*                |
| 5 Oil temperature         | 10 Display/reset miles  |

### Fuel gauge



The vehicle inclination may cause the display to vary.

Notes on refueling, refer to page 240.

### Range



After the reserve range is reached:

- ▶ A Check Control message is displayed briefly.

- ▶ The remaining range is shown on the computer.
- ▶ When a dynamic driving style is used, such as when corners are taken rapidly, engine functions are not ensured.

The Check Control message appears continuously below a range of approx. 30 miles/50 km.

-  Refuel promptly  
Refuel no later than at a range 30 miles/50 km, or engine functions are not ensured and damage may occur. ◀



## Displaying the cruising range

1. "Settings"
2. "Info display"
3. "Additional indicators"

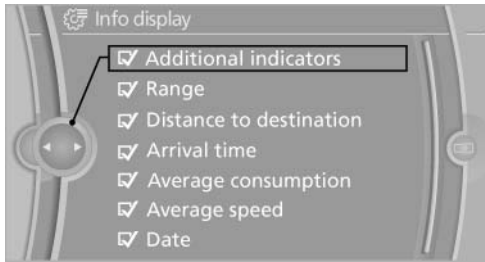

The range is displayed in the instrument cluster.

## Tachometer

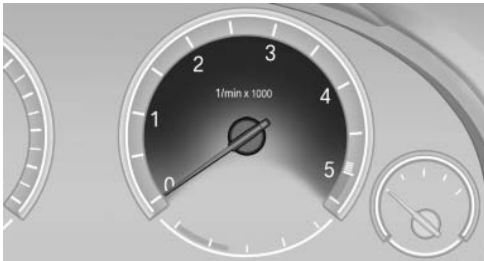

Always avoid engine speeds in the red warning field. In this range, the fuel supply is interrupted to protect the engine.

## Engine oil temperature



- ▷ Cold engine: the pointer is at the low temperature end. Drive at moderate engine and vehicle speeds.
- ▷ Normal operating temperature: the pointer is in the middle or in the left half of the temperature display.
- ▷ Hot engine: the pointer is at the high temperature end. A Check Control message is displayed in addition.

## Coolant temperature

Should the coolant, and with it the engine, become too hot, a Check Control message is displayed.

Check the coolant level, refer to page 254.

## External temperature

### External temperature warning



If the display drops to +37 °F/ +3 °C, a signal sounds.

A Check Control message is displayed.

There is the increased danger of ice.

 Ice on roads

Even at temperatures above +37 °F/+3 °C, there can be a risk of ice on roads.

Therefore, drive carefully on bridges and shady roads, for example, to avoid the increased danger of an accident. ◀

## Current fuel consumption



Displays the current fuel consumption. You can check whether you are currently driving in an efficient and environmentally-friendly manner.

## Displaying the current fuel consumption

1. "Settings"
2. "Info display"
3. "Additional indicators"

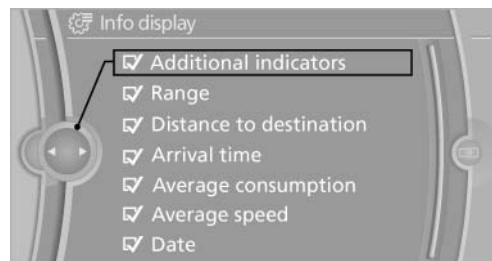

The bar display for the current fuel consumption is displayed in the instrument cluster.

## Energy recovery



The energy of motion of the vehicle is converted to electrical energy while coasting. The vehicle battery is partially charged and fuel consumption can be lowered.

## Odometer and trip odometer

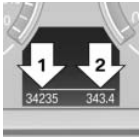

- ▷ Odometer, arrow 1.
- ▷ Trip odometer, arrow 2.

## Display/reset miles



Press the knob.

- ▷ When the ignition is switched off, the time, external temperature and odometer are displayed.
- ▷ When the ignition is switched on, the trip odometer is reset.

## Time

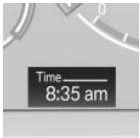

The time is displayed at the bottom of the instrument cluster.

Setting the time and time format, refer to page 81.

## Date



The date is displayed in the instrument cluster.

Setting the date and date format, refer to page 81.

## Selection lists in the instrument cluster

### The concept

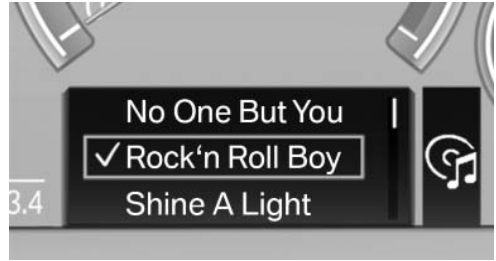

The following can be operated using the buttons and the thumbwheel on the steering wheel:

- ▷ Current audio source.
- ▷ Redial on telephone\*.
- ▷ Activation of the voice activation system\*.

### Activating a list and creating the setting

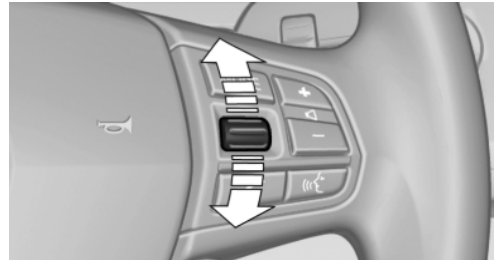

Press a button on the right side of the steering wheel or turn the thumbwheel to activate the required list.

Create the setting using the thumbwheel.

## Computer

### Indication in the info display

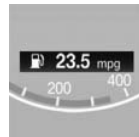

The information from the computer is shown in the Info display in the instrument cluster.

## Calling up information on the info display

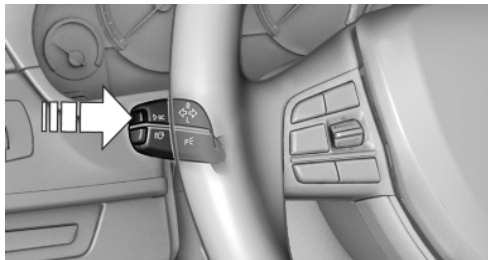

Press the computer button on the turn signal lever.

Information is displayed on the info display of the instrument cluster.

### Information at a glance

Repeatedly pressing the button on the turn signal lever calls up the following information on the info display:

- ▷ Range.
- ▷ Average fuel consumption.
- ▷ Average speed.
- ▷ Date\*.
- ▷ Time of arrival\*  
When destination guidance is activated in the navigation system.
- ▷ Distance to destination\*  
When destination guidance is activated in the navigation system.
- ▷ Arrow view of navigation system\*  
When destination guidance is activated in the navigation system.

### Adjusting the info display

You can select what information from the computer is to be displayed on the info display of the instrument cluster.

1. "Settings"
2. "Info display"

3. Select the desired displays.

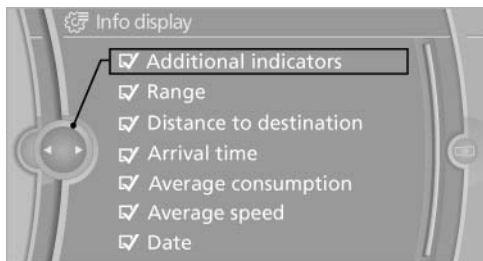

### Information in detail

#### Range

Displays the estimated cruising range available with the remaining fuel.

It is calculated based on your driving style over the last 20 miles/30 km. If there is only enough fuel left for less than 45 miles/80 km, the color of the display changes.

#### Average fuel consumption

This is calculated for the period during which the engine is running.

The average fuel consumption is calculated on the basis of various distances.

#### Average speed

Periods in which the vehicle is parked with the engine stopped do not enter into the calculation.

#### Resetting average values

Press and hold the computer button on the turn signal lever.

#### Distance to destination\*

The distance remaining to the destination is displayed if a destination is entered in the navigation system\* before the trip is started.

The distance to the destination is adopted automatically.

## Time of arrival\*



The estimated time of arrival is displayed if a destination is entered in the navigation system\* before the trip is started.

The time must be correctly set.

## Speed limit

Display of a speed limit which, when reached, should cause a warning to be issued.

Renewed warning if the vehicle speed drops below the set speed limit once by at least 3 mph/ 5 km/h.

## Displaying, setting or changing the limit

1. "Settings"
2. "Speed"
3. "Warning at:"

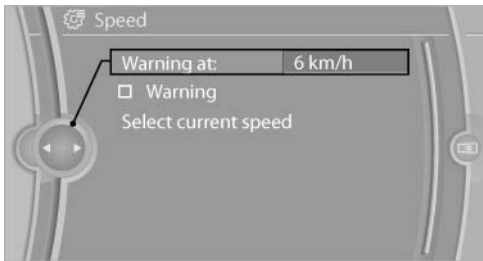

4. Turn the controller until the desired limit is displayed.
  5. Press the controller.
- The speed limit is stored.

## Activating/deactivating the limit

1. "Settings"
2. "Speed"
3. "Warning"
4. Press the controller.

## Applying your current speed as the limit

1. "Settings"
2. "Speed"

3. "Select current speed"

4. Press the controller.

The current vehicle speed is stored as the limit.

## Resetting values

The average fuel consumption and average speed can be reset.

Press and hold the computer button on the turn signal lever.

## Trip computer

There are two types of computer.

- ▶ "Onboard info": the values can be reset as often as necessary.
- ▶ "Trip computer": the values provide an overview of the current trip.

## Resetting the trip computer

1. "Vehicle Info"
2. "Trip computer"
3. "Reset": all values are reset.

"Automatically reset": all values are reset approx. 4 hours after the vehicle comes to a standstill.

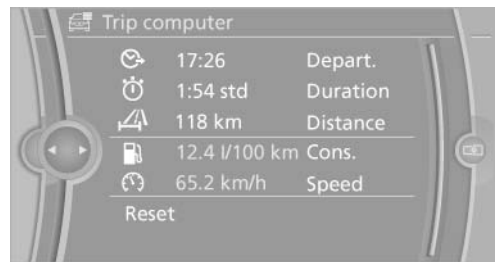

## Display on the Control Display

Display the computer or trip computer on the Control Display.

1. "Vehicle Info"
2. "Onboard info" or "Trip computer"

## Resetting the fuel consumption or speed

1. "Vehicle Info"
2. "Onboard info"
3. "Cons." or "Speed"

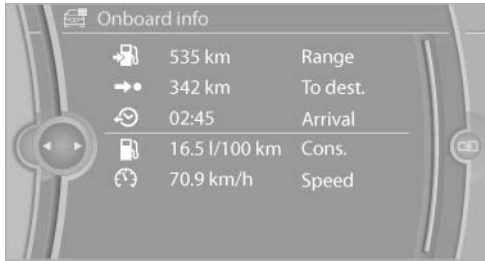

4. "Yes"

## Settings on the Control Display

### Time

#### Setting the time zone\*

1. "Settings"
2. "Time/Date"
3. "Time zone"
4. Select the desired time zone.

The time zone is stored.

#### Setting the time

1. "Settings"
2. "Time/Date"
3. "Time:"

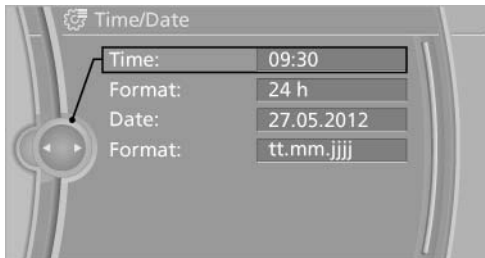

4. Turn the controller until the desired hours are displayed.
  5. Press the controller.
  6. Turn the controller until the desired minutes are displayed.
  7. Press the controller.
- The time is stored.

#### Setting the time format

1. "Settings"
  2. "Time/Date"
  3. "Format:"
  4. Select the desired format.
- The time format is stored.

### Date

#### Setting the date

1. "Settings"
2. "Time/Date"
3. "Date:"
4. Turn the controller until the desired day is displayed.
5. Press the controller.
6. Make the necessary settings for the month and year.

The date is stored.

#### Setting the date format

1. "Settings"
2. "Time/Date"
3. "Format:"
4. Select the desired format.



The date format is stored.

## Language

### Setting the language

To set the language on the Control Display:

1. "Settings"
2. "Language/Units"
3. "Language:"



4. Select the desired language.

The setting is stored for the remote control currently in use.

### Setting the voice dialog\*

Voice dialog for the voice activation system\*, refer to page 26.

## Units of measure

### Setting the units of measure

To set the units for fuel consumption, route/distance and temperature:

1. "Settings"
2. "Language/Units"
3. Select the desired menu item.

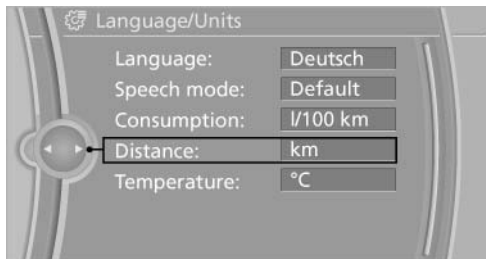

4. Select the desired unit.

The setting is stored for the remote control currently in use.

## Brightness

### Setting the brightness

To set the brightness of the Control Display:

1. "Settings"
2. "Control display"
3. "Brightness"

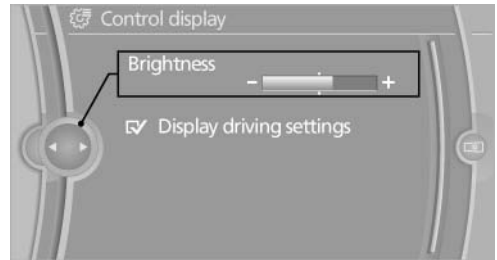

4. Turn the controller until the desired brightness is set.

5. Press the controller.

The setting is stored for the remote control currently in use.

Depending on the light conditions, the brightness control may not be clearly visible.

## Service requirements

### Display

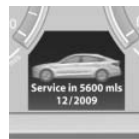

The driving distance or the time to the next service is displayed briefly after the ignition is switched on.

The current service requirements can be read out from the remote control by the service specialist.



Data regarding the maintenance status or legally mandated inspections of the vehicle are automatically transmitted to your service center before a service due date, Automatic Service Request, refer to page 232.

## Detailed information on service requirements

More information on the scope of service required can be displayed on the Control Display.

1. "Vehicle Info"
2. "Vehicle status"
3.  "Service required"  
Required maintenance procedures and legally mandated inspections are displayed.
4. Select an entry to call up detailed information.

## Symbols

Symbols	Description
	No service is currently required.
	The deadline for service or a legally mandated inspection is approaching. Please make a service appointment.
	The service deadline has already passed.

## Entering appointment dates

Enter the dates for the required inspections. Ensure that the vehicle date and time are set correctly.

1. "Vehicle Info"
2. "Vehicle status"
3.  "Service required"
4. "§ Vehicle inspection"
5. "Date:"
6. Create the settings.
7. Confirm.  
The entered date is stored.

## Automatic Service Request\*

Data regarding the maintenance status or legally mandated inspections of the vehicle are auto-

matically transmitted to your service center before a service due date.

You can check when your service center was notified.

1. "Vehicle Info"
2. "Vehicle status"
3. Open "Options".
4. "Last Service Request"

## Check Control

### The concept

The Check Control system monitors functions in the vehicle and notifies you of malfunctions in the monitored systems.

A Check Control message is displayed as a combination of indicator or warning lamps and text messages in the instrument cluster and in the Head-up Display\*.

In addition, an acoustic signal may be output and a text message may appear on the Control Display.

### Indicator/warning lamps



The indicator and warning lamps can light up in a variety of combinations and colors.

Several of the lamps are checked for proper functioning and light up temporarily when the engine is started or the ignition is switched on.

### Text messages

Text messages in combination with a symbol in the instrument cluster explain a Check Control

message and the meaning of the indicator and warning lamps.



## Supplementary text messages

Addition information, such as on the cause of a fault or the required action, can be called up via Check Control. The supplementary text of urgent messages is displayed automatically.

It is shown on the Control Display.

## Symbols

Depending on the Check Control message, the following functions can be selected.

- ▷  "Owner's Manual"  
Display additional information about the Check Control message in the integrated owner's manual.
- ▷  "Service request"  
Contact the service partner.
- ▷  "Roadside Assistance"  
Contact Roadside Assistance.

## Hiding Check Control messages

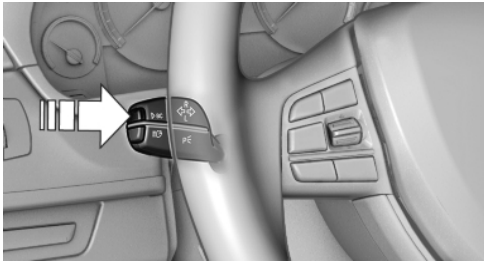

Press the computer button on the turn signal lever.

- ▷ Some Check Control messages are displayed continuously and are not cleared until the malfunction is eliminated. If several malfunctions occur at once, the messages are displayed consecutively.

These messages can be hidden for approx. 8 seconds. After this time, they are displayed again automatically.

- ▷ Other Check Control messages are hidden automatically after approx. 20 seconds.

They are stored and can be displayed again later.

## Displaying stored Check Control messages

1. "Vehicle Info"
2. "Vehicle status"
3.  "Check Control"
4. Select the text message.

## Messages after trip completion

Malfunctions indicated during a trip are displayed again after the ignition is switched off.



# Lamps

## At a glance



- 1 Rear fog lamps\*
- 2 Front fog lamps\*
- 3 Automatic headlamp control / adaptive light control\* / high-beam assistant\* / welcome lamps / daytime running lights\*
- 4 Lamps off / daytime running lights\*
- 5 Parking lamps / daytime running lights\*
- 6 Low beams / welcome lamps / high-beam assistant\*
- 7 Instrument lighting

## Parking lamps/low beams, headlamp control

### Parking lamps

Switch position : the vehicle lamps light up on all sides, e.g., for parking.

Do not use the parking lamps for extended periods; otherwise, the battery may become discharged and it would then be impossible to start the engine.

When parking, it is preferable to switch on the one-sided roadside parking lamps, refer to page 86.

### Low beams

Switch position with the ignition switched on: the low beams light up.

## Welcome lamps

When parking the vehicle, leave the switch in position or : the parking and interior lamps light up briefly when the vehicle is unlocked.

## Activating/deactivating

1. "Settings"
2. "Lighting"
3. "Welcome light"



The setting is stored for the remote control currently in use.

## Headlamp courtesy delay feature

The low beams stay lit for a short while after the ignition is switched off, if the lamps are switched off and the headlamp flasher is switched on.

## Setting the duration

1. "Settings"
2. "Lighting"
3. "Pathway light.: s"

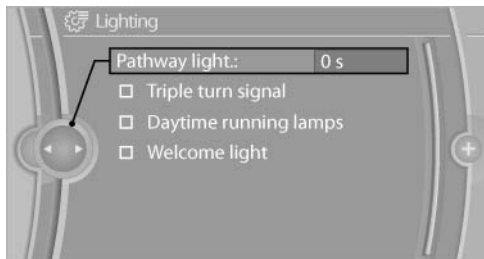

4. Set the duration.

The setting is stored for the remote control currently in use.

## Automatic headlamp control

Switch position  : the low beams are switched on and off automatically, e.g., in tunnels, in twilight or if there is precipitation. The indicator lamp in the instrument cluster lights up.

A blue sky with the sun low on the horizon can cause the lights to be switched on.

The low beams always stay on when the fog lamps are switched on.





### Personal responsibility

The automatic headlamp control cannot serve as a substitute for your personal judgment in determining when the lamps should be switched on in response to ambient lighting conditions.

For example, the sensors are unable to detect fog or hazy weather. To avoid safety risks, you should always switch on the lamps manually under these conditions. ◀

## Daytime running lights\*

With the ignition switched on, the daytime running lights light up in position 0,  or  . After the ignition is switched off, the parking lamps light up in position  .

## Activating/deactivating

1. "Settings"
2. "Lighting"
3. "Daytime running lamps"

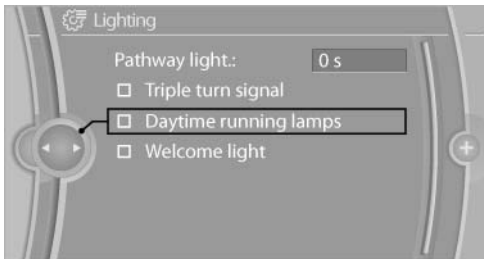

The setting is stored for the remote control currently in use.

## Roadside parking lamps

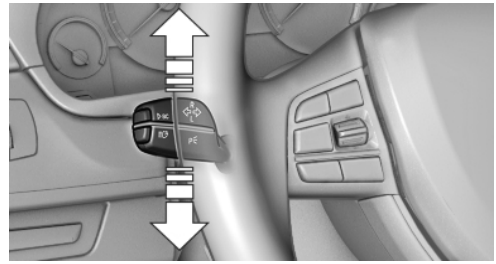

The vehicle can be illuminated on one side.

## Switching on

With the ignition switched off, press the lever either up or down past the resistance point for approx. 2 seconds.

## Switching off

Briefly press the lever to the resistance point in the opposite direction.

## Adaptive light control\*

### The concept

Adaptive light control is a variable headlamp control system that enables dynamic illumination of the road surface.

Depending on the steering angle and other parameters, the light from the headlamp follows the course of the road.

In tight curves, e.g., on mountainous roads or when turning, an additional, corner-illuminating lamp is switched on that lights up the inside of the curve when the vehicle is moving below a certain speed.

## Controls

### Activating

Switch position  with the ignition switched on.

The turning lamps are automatically switched on depending on the steering angle or the use of turn signals.

To avoid blinding oncoming traffic, the adaptive light control directs light towards the front passenger side when the vehicle is at a standstill.

When driving in reverse, only the turning lamp is active.

## Self-leveling headlights

The self-leveling headlights feature adapts the light distribution to the contours of the road.

The light distribution is lowered on hilltops to avoid blinding oncoming traffic and tilted in depressions to increase visibility.

## Malfunction

A Check Control message is displayed.

Adaptive light control is malfunctioning or has failed. Have the system checked as soon as possible.



## High-beam Assistant\*

### The concept

When the low beams are switched on, this system automatically switches the high beams on and off. The procedure is controlled by a sensor on the front of the interior rearview mirror. The assistant ensures that the high beams are switched on whenever the traffic situation allows. The driver can intervene at any time and switch the high beams on and off as usual.

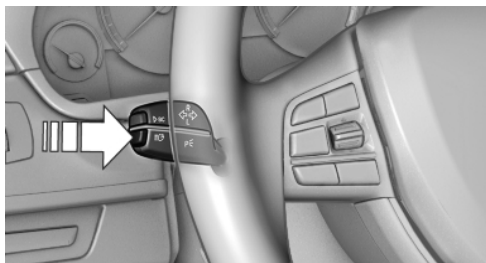
### Activating the High-beam Assistant



1. Turn the light switch to  D or .
2. Press the button on the turn signal lever, arrow.



The indicator lamp in the instrument cluster lights up.

When the lights are switched on, the high beams are switched on and off automatically.

The system responds to light from oncoming traffic and traffic driving ahead of you, and to adequate illumination, e.g., in towns and cities.

### Switching the high beams on and off manually

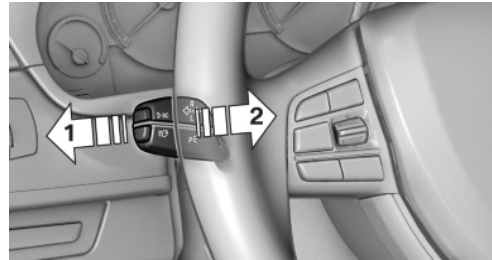

- ▷ High beams on, arrow 1.
- ▷ High beams off/headlamp flasher, arrow 2.

To reactivate the High-beam Assistant, press the button on the turn signal lever.

### System limits



Personal responsibility

The high-beam assistant cannot serve as a substitute for the driver's personal judgment of when to use the high beams. Therefore, manually switch off the high beams in situations where this is required to avoid a safety risk. ◀

The system is not fully functional in situations such as the following, and driver intervention may be necessary:

- ▷ In very unfavorable weather conditions, such as fog or heavy precipitation.
- ▷ In detecting poorly-lit road users, such as pedestrians, cyclists, horseback riders and wagons; when driving close to train or ship traffic; and at animal crossings.
- ▷ In tight curves, on hilltops or in depressions, in cross traffic or half-observed oncoming traffic on freeways.

- ▷ In poorly-lit towns and cities and in the presence of highly reflective signs.
- ▷ At low speeds.
- ▷ When the windshield in front of the interior rearview mirror is fogged over, dirty or covered with stickers, etc.

## Camera

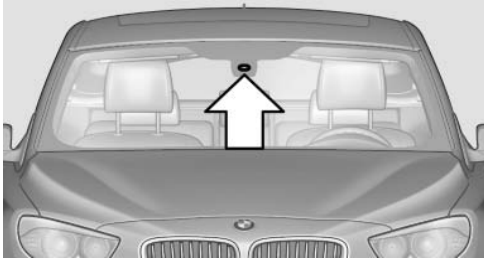

The camera is located on the front of the interior rearview mirror.

Keep the area in front of the interior rearview mirror clear.

## Fog lamps

### Front fog lamps\*

The parking lamps or low beams must be switched on.

 Press the button. The green indicator lamp lights up.

If the automatic headlamp control, refer to page 86, is activated, the low beams will come on automatically when you switch on the front fog lamps.

## Instrument lighting

### Adjusting



The parking lamps or low beams must be switched on to adjust the brightness.

Adjust the brightness using the thumbwheel.

## Interior lamps

### General information

The interior lamps, footwell lamps, entry lamps and courtesy lamps are controlled automatically.

The brightness of some of these lamps is influenced by the thumbwheel for the instrument lighting.



- 1 Interior lamps
- 2 Reading lamp

### Switching the interior lamps on and off



Press the button.

To switch off permanently: press the button for approx. 3 seconds.

To clear this setting: press the button.

### Reading lamps



Press the button.

Reading lamps are located at the front and rear next to the interior lamps.

## Airbags

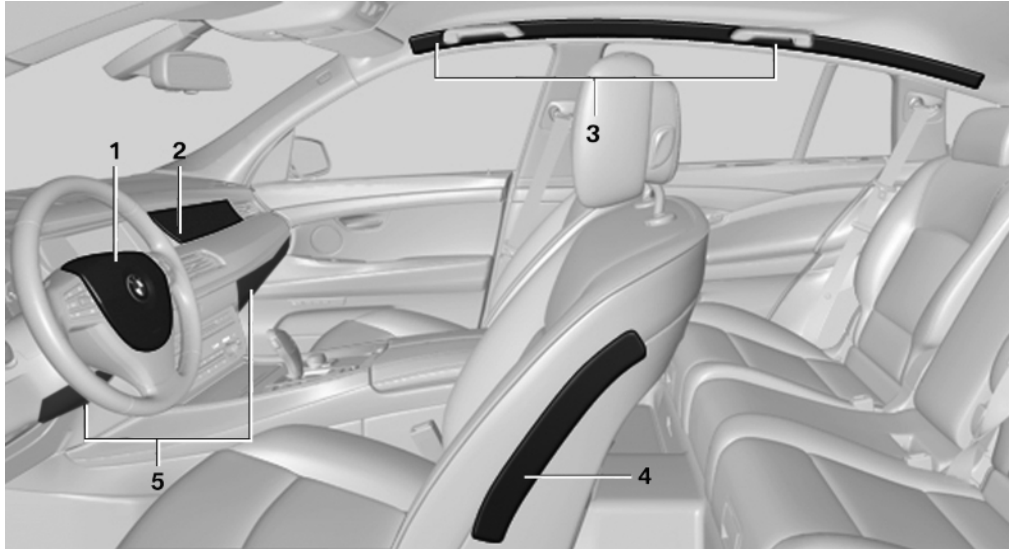

- 1 Front airbag, driver
- 2 Front airbag, front passenger
- 3 Head airbag
- 4 Side airbag
- 5 Knee airbags

### Front airbags

Front airbags help protect the driver and front passenger by responding to frontal impacts in which safety belts alone cannot provide adequate restraint.

### Side airbags

In a lateral impact, the side airbag supports the side of the body in the chest and lap area.

### Head airbags

In a lateral impact, the head airbag supports the head.

### Knee airbag

The knee airbag supports the legs in a frontal impact.

### Protective action

Airbags are not triggered in every impact situation, e.g., in less severe accidents or rear-end collisions.



Information on how to ensure the optimal protective effect of the airbags

- Keep at a distance from the airbags.
- Always grasp the steering wheel on the steering wheel rim, holding your hands at the 3 o'clock and 9 o'clock positions, to keep the danger of injury to your hands or arms as low as possible if the airbag is triggered.
- There should be no people, animals, or objects between an airbag and a person.
- Do not use the cover of the front airbag on the front passenger side as a storage area.

- ▷ Keep the dashboard and window on the front passenger side clear, i.e., do not cover with adhesive labels or coverings, and do not attach holders such as for navigation instruments and mobile phones.
- ▷ Make sure that the front passenger is sitting correctly, i.e., keeps his or her feet and legs in the footwell; otherwise, leg injuries can occur if the front airbag is triggered.
- ▷ Do not place slip covers, seat cushions or other objects on the front passenger seat that are not approved specifically for seats with integrated side airbags.
- ▷ Do not hang pieces of clothing, such as jackets, over the backrests.
- ▷ Make sure that occupants keep their heads away from the side airbag and do not rest against the head airbag; otherwise, injuries can occur if the airbags are triggered.
- ▷ Do not remove the airbag restraint system.
- ▷ Do not remove the steering wheel.
- ▷ Do not apply adhesive materials to the airbag cover panels, cover them or modify them in any way.
- ▷ Never modify either the individual components or the wiring in the airbag system. This also applies to steering wheel covers, the dashboard, the seats, the roof pillars and the sides of the headliner. ◀

Even when all instructions are followed closely, injury from contact with the airbags cannot be ruled out in certain situations.

The ignition and inflation noise may lead to short-term and, in most cases, temporary hearing impairment in sensitive individuals.

 In the case of a malfunction, deactivation and after triggering of the airbags

Do not touch the individual components immediately after the system has been triggered; otherwise, there is the danger of burns.

Only have the airbags checked, repaired or dismantled and the airbag generator scrapped by your service center or a workshop that has the necessary authorization for handling explosives.

Non-professional attempts to service the system could lead to failure in an emergency or undesired triggering of the airbag, either of which could result in injury. ◀

Warnings and information on the airbags are also found on the sun visors.

## Functional readiness of the airbag system



When the ignition is switch on, the warning lamp in the instrument cluster lights up briefly and thereby indicates the operational readiness of the entire airbag system and the belt tensioner.

## Airbag system malfunctioning

- ▷ In radio ready state, the warning lamp does not come on.
- ▷ The warning lamp lights up continuously.



When there is a malfunction, have the airbag system checked immediately

When there is a malfunction, have the airbag system checked immediately; otherwise, there is a risk that the system does not function as expected in the event of an accident despite corresponding severity of the accident. ◀

## Automatic deactivation of the front passenger airbags

The system determines whether the front passenger seat is occupied by measuring the resistance of the human body.

The front, knee, and side airbag on the front passenger side are activated or deactivated accordingly.



Leave feet in the footwell

Make sure that the front passenger keeps his or her feet in the footwell; otherwise, the front passenger airbags may not function properly. ◀



Child restraint fixing system in the front passenger seat

Before transporting a child on the front passenger seat, see the safety notes and instructions under Children on the front passenger seat. ◀

### Malfunction of the automatic deactivation system

When transporting older children and adults, the front passenger airbags may be deactivated in certain sitting positions. In this case, the indicator lamp for the front passenger airbags lights up.

In this case, change the sitting position so that the front passenger airbags are activated and the indicator lamp goes out.

If it is not possible to activate the airbags, have the person sit in the rear.

To make sure that the occupied seat cushion can be evaluated correctly

- ▷ Do not attach covers, cushions, ball mats or other items to the front passenger seat unless they are specifically recommended by the manufacturer of your vehicle.
- ▷ Do not place any objects on the front passenger seat.
- ▷ Do not place objects under the seat that could press against the seat from below.

### Indicator lamp for the front passenger airbags



The indicator lamp for the front passenger airbags indicates the operating state of the front passenger airbags.

The lamp indicates whether the airbags are activated or deactivated.



▷ The indicator lamp lights up when a child who is properly seated in a child restraint fixing system intended for that purpose is detected on the seat or the seat is empty. The airbags on the front passenger side are not activated.

▷ The indicator lamp does not light up when, for example, a correctly seated person of sufficient size is detected on the seat. The airbags on the front passenger side are activated.

The system generally detects children seated in a child seat, especially in the child seats that were required by NHTSA when the vehicle was manufactured. After installing a child seat, make sure that the indicator lamp for the front passenger airbags lights up. This indicates that the child seat has been detected and the front passenger airbags are not activated.

### Strength of the driver's and front passenger airbag

The strength with which the driver's and front passenger airbags are triggered depends on the position of the driver's and front passenger seats.

To maintain the accuracy of this function over the long-term, calibrate the front seats when a corresponding message appears on the Control Display.

### Calibrating the front seats

A corresponding message appears on the Control Display.

1. Move the respective seat forward all the way.
2. Move the respective seat forward again. It moves forward briefly.
3. Readjust the seat to the desired position.

The calibration procedure is completed when the message on the Control Display disappears.

If the message continues to be displayed, repeat the calibration.



If the message does not disappear after a repeat calibration, have the system checked as soon as possible.



Unobstructed area of movement

Ensure that the area of movement of the seats is unobstructed to avoid personal injury or damage to objects. ◀

## Tire Pressure Monitor TPM\*

### The concept

The tire inflation pressure is measured in the four mounted tires. The system notifies you if there is a significant loss of pressure in one or more tires.

### Functional requirements

The system must have been reset when the inflation pressure was correct; otherwise, reliable signaling of a flat tire is not ensured. Always use wheels with TPM electronics to ensure that the system will operate properly. Reset the system after each correction of the tire inflation pressure and after every tire or wheel change.

### System limits



Sudden tire damage

Sudden serious tire damage caused by external influences cannot be indicated in advance. ◀

The system does not operate correctly if it has not been reset. For example, a flat tire may be indicated despite correct tire inflation pressures.

The system is inactive and cannot indicate a flat tire:

- ▷ For a mounted wheel without TPM electronics.
- ▷ When the TPM is disturbed by other systems or devices with the same radio frequency.

### Status display

The current status of the Tire Pressure Monitor TPM can be displayed on the Control Display, e.g., whether or not the TPM is active.

1. "Vehicle Info"
2. "Vehicle status"
3. (!) "Tire Pressure Monitor - TPM"

The status is displayed.

### Status display

The tire and system status is indicated by the color of the tires.

A change in the tire inflation pressure during driving is taken into account.

A correction is only necessary if this is indicated by the TPM

### Wheels, green

The tire inflation pressure is equal to the target state.

### One wheel is yellow

A flat tire or major drop in inflation pressure in the indicated tire.

### All wheels are yellow

- ▷ A flat tire or major drop in inflation pressure in several tires.
- ▷ The system was not reset after a wheel change and thus warns based on the inflation pressures initialized last.
- ▷ A flat tire in one or more tires while the system is being reset.

### Wheels, gray

The system cannot detect a flat tire. Reasons for this may be:

- ▷ TPM is being reset.
- ▷ Disturbance by systems or devices with the same radio frequency.
- ▷ Malfunction.



## For Canadian models: additional information

The status display additionally shows the current tire inflation pressures and tire temperatures.

When correcting the tire inflation pressures, note the following:

The tire pressure increases as the tire temperature increases.

Therefore, only correct the tire inflation pressure when the tire is at the ambient temperature. Compare the displayed tire temperature with the external temperature in the instrument cluster.

## Resetting the system

Reset the system after each correction of the tire inflation pressure and after every tire or wheel change.

1. "Vehicle Info"
2. "Vehicle status"
3.  "Reset"
4. Start the engine - do not drive away.
5. Reset the tire pressure using "Reset".
6. Drive away.

The tires are shown in gray and "Resetting TPM..." is displayed.

After driving for a few minutes, the set tire inflation pressures are applied as set values. The resetting process is completed automatically during driving. The tires are shown in green and "TPM active" is shown on the Control Display.

The trip can be interrupted at any time. If you drive away again, the process resumes automatically.

If a flat tire is detected during a reset, all tires are displayed in yellow.

## Low tire pressure message



The yellow warning lamp lights up. A Check Control message is displayed.

- ▶ There is a flat tire or a major loss in tire inflation pressure.

▶ The system was not reset after a wheel change and thus warns based on the inflation pressures initialized last.

1. Reduce your speed and stop cautiously. Avoid sudden braking and steering maneuvers.
2. Check whether the vehicle is fitted with regular tires\* or run-flat tires\*.

Run-flat tires, refer to page 249, are labeled with a circular symbol containing the letters RSC marked on the tire sidewall.

When a low inflation pressure is indicated, DSC Dynamic Stability Control is switched on if necessary.

## Actions in the event of a flat tire

### Normal tires\*

1. Identify the damaged tire.

Do this by checking the air pressure in all four tires.

If the tire inflation pressure in all four tires is correct, the Tire Pressure Monitor may not have been initialized. In this case, initialize the system.

If an identification is not possible, please contact the service center.

2. Rectify the flat tire.

Use of tire sealant, e.g., the Mobility System, may damage the TPM wheel electronics. In this case, have the electronics checked at the next opportunity and have them replaced if necessary.

### Run-flat tires\*

You can continue driving with a damaged tire at speeds up to 50 mph/80 km/h.



Do not continue driving without run-flat tires

Do not continue driving if the vehicle is not equipped with run-flat tires; continued driving may result in serious accidents. ◀

## Continued driving with a flat tire

If continuing to drive with a damaged tire:

1. Avoid sudden braking and steering maneuvers.
2. Do not exceed a speed of 50 mph/80 km/h.
3. Check the air pressure in all four tires at the next opportunity.

If the tire inflation pressure in all four tires is correct, the Tire Pressure Monitor may not have been initialized. In this case, initialize the system.

Possible driving distance with complete loss of tire inflation pressure:

The possible driving distance after a loss of tire inflation pressure depends on the cargo load and the driving style and conditions.

For a vehicle containing an average load, the possible driving distance is approx. 50 miles/ 80 km.

When the vehicle is driven with a damaged tire, its handling characteristics change, e.g., reduced lane stability during braking, a longer braking distance, and altered self-steering properties. Adjust your driving style accordingly. Avoid abrupt steering maneuvers or driving over obstacles, e.g., curbs, potholes, etc.

Because the possible driving distance depends on how the vehicle is used during the trip, the actual distance may be smaller or greater depending on the driving speed, road conditions, external temperature, cargo load, etc.



Continued driving with a flat tire

Drive moderately and do not exceed a speed of 50 mph/80 km/h.

A loss of tire inflation pressure results in a change in the handling characteristics, e.g., reduced lane stability during braking, a longer braking distance and altered self-steering properties. ◀



Final tire failure

Vibrations or loud noises while driving can indicate the final failure of the tire. Reduce speed and stop; otherwise, pieces of the tire could

come loose and cause an accident. Do not continue driving, and contact your service center. ◀

## Message when the system was not reset

A Check Control message is displayed.

The system detected a wheel change but was not reset.

Warnings regarding the current tire inflation pressure are not reliable.

Check the tire inflation pressure and reset the system.

## Malfunction



The yellow warning lamp flashes and then lights up continuously. A Check Control message is displayed. No flat tire can be detected.

Display in the following situations:

- ▶ A wheel without TPM electronics is fitted: have the service center check it if necessary.
- ▶ Malfunction: have the system checked by your service center.
- ▶ TPM could not be fully reset. Reset the system again.
- ▶ Disturbance by systems or devices with the same radio frequency: after leaving the area of the disturbance, the system automatically becomes active again.

## Declaration according to NHTSA/ FMVSS 138 Tire Pressure Monitoring System

Each tire, including the spare (if provided) should be checked monthly when cold and inflated to the inflation pressure recommended by the vehicle manufacturer on the vehicle placard or tire inflation pressure label. (If your vehicle has tires of a different size than the size indicated on the vehicle placard or tire inflation pressure label, you should determine the proper tire inflation pressure for those tires.) As an added safety feature, your vehicle has been equipped with a tire pressure monitoring system (TPMS) that illuminates a low tire pressure telltale when one

or more of your tires is significantly under-inflated. Accordingly, when the low tire pressure telltale illuminates, you should stop and check your tires as soon as possible, and inflate them to the proper pressure. Driving on a significantly under-inflated tire causes the tire to overheat and can lead to tire failure. Under-inflation also reduces fuel efficiency and tire tread life, and may affect the vehicle's handling and stopping ability. Please note that the TPMS is not a substitute for proper tire maintenance, and it is the driver's responsibility to maintain correct tire pressure, even if under-inflation has not reached the level to trigger illumination of the TPMS low tire pressure telltale. Your vehicle has also been equipped with a TPMS malfunction indicator to indicate when the system is not operating properly. The TPMS malfunction indicator is combined with the low tire pressure telltale. When the system detects a malfunction, the telltale will flash for approximately one minute and then remain continuously illuminated. This sequence will continue upon subsequent vehicle start-ups as long as the malfunction exists. When the malfunction indicator is illuminated, the system may not be able to detect or signal low tire pressure as intended. TPMS malfunctions may occur for a variety of reasons, including the installation of replacement or alternate tires or wheels on the vehicle that prevent the TPMS from functioning properly. Always check the TPMS malfunction telltale after replacing one or more tires or wheels on your vehicle to ensure that the replacement or alternate tires and wheels allow the TPMS to continue to function properly.

## Lane departure warning\*

### The concept

This system issues a warning at speeds above approx. 40 mph/65 km/h if the vehicle is about to leave the lane on roads with lane markings.

The steering wheel begins vibrating gently.

The system does not provide a warning if the turn signal is set before leaving the lane.

### Switching on/off



 Press the button.

- ▷ On: the LED lights up.
- ▷ Off: the LED goes out.

The system can issue warnings at speeds above approx. 40 mph/65 km/h.

The state is stored for the remote control currently in use.

### Display

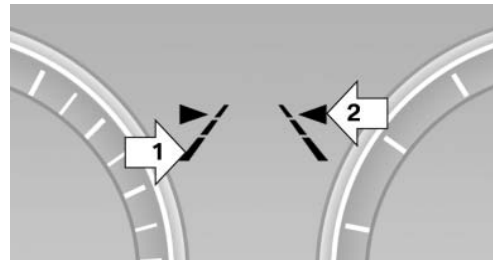

- ▷ Lines, arrow 1: the system is activated.
- ▷ Arrows, arrow 2: at least one lane marking was detected and warnings can be issued.

### Issued warning

If you leave the lane and if a lane marking has been detected, the steering wheel begins vibrating.

If the turn signal is set before changing the lane, a warning is not issued.

### End of warning

The warning ends:

- ▷ Automatically after approx. 3 seconds.
- ▷ When returning to your own lane.

- ▷ When braking hard.
- ▷ When using the turn signal.

## System limits



### Personal responsibility

The system cannot serve as a substitute for the driver's personal judgment of the course of the road and the traffic situation.

In the event of a warning, do not jerk the steering wheel, as you may lose control of the vehicle. ◀

The system may not be fully functional in the following situations:

- ▷ In heavy fog, rain or snowfall.
- ▷ In the event of worn, poorly visible, merging, diverging, or multiple lane markings such as in construction areas.
- ▷ When lane markings are covered in snow, ice, dirt or water.
- ▷ In tight curves or on narrow lanes.
- ▷ When the lane markings are covered by objects.
- ▷ When driving very close to the vehicle in front of you.
- ▷ When driving toward bright lights.
- ▷ When the windshield in front of the interior rearview mirror is fogged over, dirty or covered with stickers, etc.

## Malfunctions

### Steering wheel vibration

Frequent activation of the steering wheel vibration causes the system to overheat.

This causes the lane departure warning to become deactivated.

Let the system cool and reactivate it by pressing the button.

## Camera

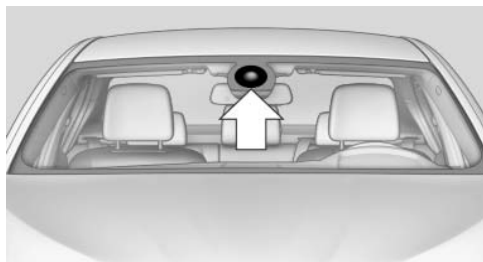

The camera is located on the front of the interior rearview mirror.

Keep the area in front of the interior rearview mirror clear.

## Active Blind Spot Detection\*

### The concept

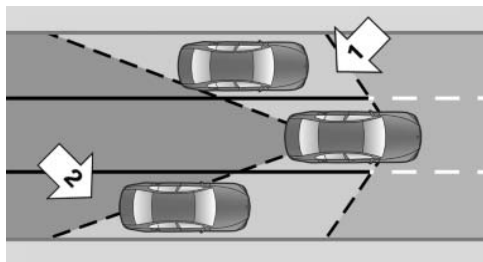

Two radar sensors below the rear bumper monitor the area behind and next to the vehicle at speeds above approx. 30 mph/50 km/h.

The system indicates whether there are vehicles in the blind spot, arrow 1, or approaching from behind on the adjacent lane, arrow 2.

The lamp in the exterior mirror housing lights up dimly.

Before you change lanes after setting the turn signal, the system issues a warning in the situations described above.

The lamp in the housing of the exterior mirror flashes and the steering wheel vibrates.

## Switching on/off



Press the button.

- ▷ On: the LED lights up.
- ▷ Off: the LED goes out.

The system can issue warnings at speeds above approx. 30 mph/50 km/h.

The state is stored for the remote control currently in use.

## Display

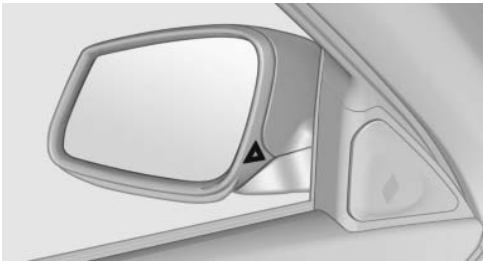

## Information stage

The dimmed lamp in the mirror housing indicates when there are vehicles in the blind spot or approaching from behind.

## Warning

If the turn signal is set while a vehicle is in the critical zone, the steering wheel vibrates briefly and the lamp in the mirror housing flashes brightly.

The warning stops when the turn signal is switched off, or the other vehicle leaves the critical zone.

## System limits



Personal responsibility

The system cannot serve as a substitute for the driver's personal judgment of the traffic situation.

In the event of a warning, do not jerk the steering wheel, as you may lose control over the vehicle. ◀

The system may not be fully functional in the following situations:

- ▷ When a vehicle is approaching at a speed much faster than your own.
- ▷ In heavy fog, rain or snowfall.
- ▷ In tight curves or on narrow lanes.

## Malfunctions

### Steering wheel vibration

Frequent activation of the steering wheel vibration causes the system to overheat.

This causes Active Blind Spot Detection to become deactivated.

Let the system cool and reactivate it by pressing the button.

### Radar sensors



The radar sensors are located under the rear bumper.

The system may not be fully functional in the following situations:

- ▷ Dirty or icy bumper.
- ▷ Stickers on the bumper.

A Check Control message is displayed when the system is not fully functional.

## For US owners only

The transmitter and receiver units comply with part 15 of the FCC/Federal Communication Commission regulations. Operation is governed by the following:

FCC ID:

- ▷ NBG009014A.

Compliance statement:

This device complies with part 15 of the FCC Rules. Operation is subject to the following two conditions:

- ▷ This device may not cause harmful interference, and
- ▷ this device must accept any interference received, including interference that may cause undesired operation.

Any unauthorized modifications or changes to these devices could void the user's authority to operate this equipment.

## Brake force display\*

### The concept



- ▷ During normal brake application, the outer brake lamps light up.
- ▷ During heavy brake application, the inner brake lamps light up in addition.

# Driving stability control systems

## Antilock Brake System ABS

ABS prevents locking of the wheels during braking.

The vehicle remains steerable even during full brake applications, thus increasing active safety.

ABS is operational every time you start the engine.

## Brake assistant

When you apply the brakes rapidly, this system automatically produces the maximum braking force boost. It thus helps to achieve the shortest possible braking distance during full braking. This system utilizes all of the benefits provided by ABS.

Do not reduce the pressure on the brake pedal for the duration of the full braking.

## Adaptive brake assistant

In combination with the Active Cruise Control, this system ensures that the brakes respond even more rapidly when braking in critical situations. Refer also to Collision warning, refer to page 112.

## Drive-off assistant

This system supports driving away on gradients. The parking brake is not required.

1. Hold the vehicle in place with the foot brake.
2. Release the foot brake and drive away without delay.

After the foot brake is released, the vehicle is held in place for approx. 2 seconds.

Depending on the vehicle load, the vehicle may roll back slightly.



Driving off without delay

After releasing the foot brake, start driving without delay, since the drive-off assistant will not hold the vehicle in place for more than approx. 2 seconds and the vehicle will begin rolling back. ◀

## DSC Dynamic Stability Control

### The concept

DSC prevents traction loss in the driving wheels when driving away and accelerating.

DSC also recognizes unstable vehicle conditions, such as fishtailing or nose-diving. Subject to physical limits, DSC helps to keep the vehicle on a steady course by reducing engine speed and by applying brakes at individual wheels.



Adjust your driving style to the situation

An appropriate driving style is always the responsibility of the driver.

The laws of physics cannot be repealed, even with DSC.

Therefore, do not reduce the additional safety margin by driving in a risky manner. ◀

### Deactivating DSC: DSC OFF

DSC can be deactivated. To do this, activate the DSC OFF program.

This is performed via the Dynamic Driving Control, refer to page 103.

### Indicator/warning lamps



The indicator lamp flashes: DSC controls the drive forces and brake forces.

The indicator lamp lights up: DSC has failed.

## DTC Dynamic Traction Control

### The concept

The DTC system is a version of the DSC in which forward momentum is optimized.

The system ensures maximum forward momentum on special road conditions, e.g., unplowed snowy roads, but driving stability is limited.

It is therefore necessary to drive with appropriate caution.

You may find it useful to briefly activate DTC under the following special circumstances:

- ▷ When driving in slush or on uncleared, snow-covered roads.
- ▷ When rocking the vehicle or driving off in deep snow or on loose surfaces.
- ▷ When driving with snow chains.

### Deactivating/activating DTC Dynamic Traction Control

The system can be deactivated/activated via the TRACTION and SPORT+ programs of the Dynamic Driving Control, refer to page 103.

### xDrive\*

xDrive is the all-wheel-drive system of your vehicle. Concerted action by the xDrive and DSC further optimize traction and driving dynamics. The xDrive all-wheel-drive system variably distributes the drive forces to the front and rear axles as demanded by the driving situation and road surface.

## HDC Hill Descent Control\*

### The concept

HDC is a downhill driving assistant that automatically controls vehicle speed on steep downhill gradients. Without requiring brake application, the vehicle moves at slightly more than twice walking speed.

You can activate the Hill Descent Control at speeds below approx. 22 mph/35 km/h. When driving downhill, the vehicle reduces its speed to approx. twice walking speed and then keeps its speed constant.

While you are actively braking, the system is on standby. The system does not brake the vehicle during this time.

### Increasing or decreasing vehicle speed

You can specify your desired speed in the range from approx. 4 mph/6 km/h to approx. 15 mph/25 km/h using the rocker switch of the cruise control on the steering wheel. You can change the vehicle speed by pressing on the accelerator lightly.

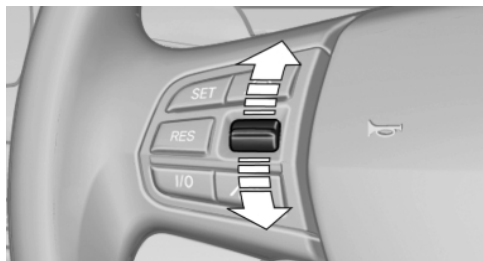

- ▷ Press up the rocker switch to the point of resistance: the speed increases gradually.
- ▷ Press up the rocker switch past the point of resistance: the speed increases while the rocker switch is pressed.
- ▷ Press down the rocker switch to the point of resistance: the speed decreases gradually.
- ▷ Press down the rocker switch past the point of resistance: when driving forward, the speed decreases to approx. 6 mph/10 km/h; when reversing, the speed decreases to approx. 4 mph/6 km/h.



## Activating HDC



 Press the button; the LED above the button lights up.

## Deactivating HDC

 Press the button again and the LED goes out. HDC is automatically deactivated above approx. 37 mph/60 km/h.

## Display in the instrument cluster



The selected speed is displayed in the speedometer.

- ▷ Green: the system is actively braking the vehicle.
- ▷ Orange: the system is on standby.

## Malfunction

A message is displayed in the instrument cluster. HDC is not available, e.g., due to elevated brake temperatures.

## Adaptive Drive\*

### The concept

Adaptive Drive\* includes the following systems:

- ▷ Dynamic Drive, refer to page 101
- ▷ Dynamic Damping Control, refer to page 101

The system increases driving stability and driving comfort.

## Dynamic Drive\*

### The concept

Dynamic Drive reduces the lateral inclination of the vehicle that occurs during rapid driving in curves or during quick evasive maneuvers.

Driving stability and driving comfort are increased under all driving conditions. The system utilizes active stabilizer bars on the front and rear axles that react immediately to all driving situations.

### Programs

The system offers two different programs.

The programs can be selected via Dynamic Driving Control, refer to page 103.

### SPORT

Sporty tuning for greater driving agility.

### NORMAL

Comfort-oriented tuning for optimal comfort.

## Dynamic Damping Control\*

### The concept

This system reduces undesirable vehicle motion when using a dynamic driving style or traveling on uneven road surfaces.

The system enhances driving dynamics and comfort as required for the road surface and driving style.

### Programs

The system offers three different programs.

The programs can be selected via Dynamic Driving Control, refer to page 103.

### SPORT

Consistently sporty control of the shock absorbers for greater driving agility.

## NORMAL

Balanced tuning between the COMFORT and SPORT programs.

## COMFORT

Comfort-oriented tuning of the shock absorbers for optimal traveling comfort.

## Integral Active Steering\*

### The concept

Integral Active Steering is a combination of Active Steering and rear axle steering.

Active Steering varies the steering angle of the wheels in relation to the steering wheel movement as a function of the speed.

At speeds up to approx. 37 mph/60 km/h, e.g., in curves, the steering angle is increased, i.e., steering becomes more direct.

The rear axle steering acts to increase maneuverability by turning the rear wheels slightly in a direction opposite to the front wheels.

At higher speeds, the steering angle is increasingly reduced.

The rear wheels are turned to the same angle as the front wheels.

In critical situations, Integral Active Steering can specifically steer the front and rear wheels to stabilize the vehicle before the driver intervenes, e.g., when braking where road conditions differ on the left and right sides of the vehicle.

### Initializing

In rare cases, it may become necessary to initialize the Integral Active Steering.



The warning lamp lights up. A Check Control message is displayed.

1. With the engine running, turn the steering wheel all the way to the left and right several times in a uniform manner until the warning lamp disappears.
2. Have the system checked if the warning lamp does not go out after moving the steer-

ing wheel approx. 6 times or if the steering wheel is at an angle.

## Using snow chains

Ensure that the rear axle steering is deactivated when using snow chains, refer to page 250.

## Programs

The system offers two different programs.

The programs can be selected via Dynamic Driving Control, refer to page 103.

## SPORT

Consistently sporty tuning of the Integral Active Steering for greater driving agility.

## NORMAL

Balanced tuning of the Integral Active Steering for optimal traveling comfort.

## Malfunction

In the event of a malfunction, the steering wheel must be turned further, while the vehicle responds more sensitively to steering wheel movements in the higher speed range.

The stability-enhancing intervention may be deactivated.

Proceed cautiously and drive defensively.

Have the system checked.

## Self-leveling suspension\*

### The concept

The self-leveling suspension keeps the vehicle height and ground clearance constant. The height of the vehicle at the rear axle is maintained at a predefined level under all load conditions.

The system ensures consistent comfort by keeping spring travel constant in all driving situations.

## Malfunction



A Check Control message is displayed. A malfunction has occurred in the self-leveling suspension. Vehicle handling may be altered and driving comfort may be noticeably reduced. Visit your nearest service center.

## Dynamic Driving Control\*

### The concept

Dynamic Driving Control can be used to adjust the driving dynamics of the vehicle. Several programs are available for this purpose; they can be activated using the two Dynamic Driving Control buttons.

### Operating the programs

Press the button	Program
	DSC OFF TRACTION
	SPORT+ SPORT NORMAL COMFORT*

For Dynamic Damper Control\*, the lower button is labeled with COMFORT.

### Automatic program change

The system automatically switches to NORMAL in the following situations:

- ▷ Failure of Integral Active Steering\*.
- ▷ Failure of Dynamic Damping Control\*.
- ▷ The vehicle has a flat tire.

## DSC OFF

Driving stability is limited during acceleration and when driving in bends.

Stabilizing interventions by the Integral Active Steering\* system are only performed by the rear axle steering.

To increase vehicle stability, activate DSC again as soon as possible.

### Activating DSC OFF



Press and hold the button, but not longer than approx. 10 seconds, until the indicator lamp for the DSC lights up in the instrument cluster and DSC OFF is displayed in the tachometer.

The DSC system is switched off.

### Deactivating DSC OFF



Press the button.

DSC OFF and the DSC indicator lamp go out.

### Indicator/warning lamps

When DSC OFF is activated, DSC OFF is displayed in the tachometer.



The indicator lamp lights up: DSC OFF is activated.

## TRACTION

Maximum traction on loose road surfaces. DTC Dynamic Traction Control is switched on. Driving stability is limited during acceleration and when driving in bends.

### Activating TRACTION



Press the button.

TRACTION is displayed in the tachometer.

The DSC indicator lamp in the instrument cluster lights up.

### Deactivating TRACTION



Press the button again.

TRACTION and the DSC indicator lamp go out.

### Indicator/warning lamps

When TRACTION is activated, TRACTION is displayed in the tachometer.



The indicator lamp lights up: TRACTION is activated.

## SPORT+

Sporty driving with optimized chassis and suspension during limited driving stabilization.

Dynamic Traction Control is switched on.

The driver handles several of the stabilization tasks.

### Activating SPORT+



Press the button repeatedly until SPORT+ appears in the tachometer and the DSC indicator lamp lights up in the instrument cluster.

### Indicator/warning lamps

SPORT+ is displayed in the instrument cluster.



The indicator lamp lights up: DTC Dynamic Traction Control is activated.

## SPORT

Consistently sporty tuning of the suspension for greater driving agility with maximum driving stabilization.

The program can be configured to individual specifications.

The configuration is stored for the remote control currently in use.

### Activating SPORT



Press the button repeatedly until SPORT appears in the tachometer.

### Configuring SPORT

When the display is activated on the Control Display, refer to page 105, the sport program can be set to individual specifications.

After the sport program is activated, select "Configure SPORT mode" on the displayed panel and configure the program.

Optionally, the sport program can be configured before it is activated:

1. "Settings"
2. "SPORT mode"

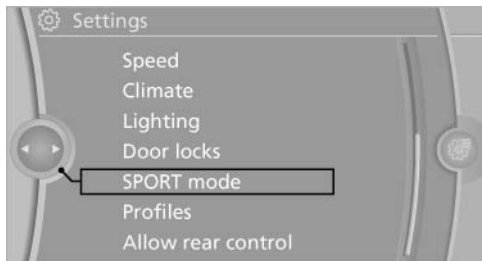

3. Configure the program.

This configuration is retrieved when the sport program is activated.

## NORMAL

For a balanced tuning with maximum driving stabilization.

### Activating NORMAL



Press the button repeatedly until the program display in the tachometer goes out.

In certain situations, the system automatically changes to the NORMAL program, automatic program change, refer to page 103.

## COMFORT\*

Comfort-oriented tuning of the shock absorbers for optimal traveling comfort with maximum driving stabilization.

### Activating COMFORT



Press the button repeatedly until COMFORT appears in the tachometer.

## Displays in the instrument cluster

### Selected program

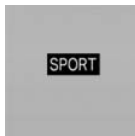

The selected program is displayed in the tachometer.

## Program selection

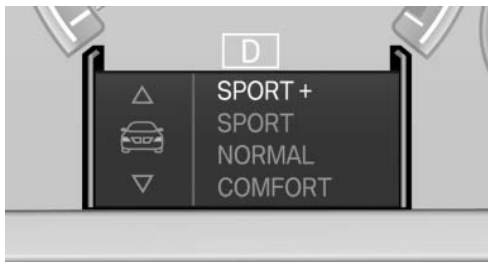

Pressing the button displays a list of the selectable programs.

### Display on the Control Display

Program changes can be displayed briefly on the Control Display.

To do so, make the following settings:

1. "Settings"
2. "Control display"
3. "Display driving settings"

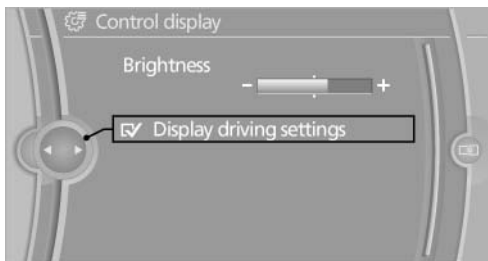

# Driving comfort

## Active Cruise Control with Stop & Go function, ACC\*

### The concept

This system can be used to select a desired speed that the vehicle will maintain automatically on clear roads.

To the extent possible, the system automatically adjusts the speed to a slower vehicle ahead of you.

The distance that the vehicle maintains to the vehicle ahead of you can be varied.

For safety reasons, it depends on the speed.

To maintain a certain distance, the system automatically decelerates, applies the brakes lightly, or accelerates again if the vehicle ahead begins moving faster.

If the vehicle ahead of you brakes to a halt, the system is able to detect this within the given system limits. If the vehicle ahead of your drives away again from a halt, your vehicle is able to accelerate if operated accordingly.

Even if some time passes before the vehicle drives away again, the BMW can still be accelerated automatically and simply.

As soon as the road is clear, it accelerates to the desired speed.

The speed is also maintained on downhill gradients, but may not be maintained on uphill slopes if engine power is insufficient.

### Buttons at a glance



- 1 System on/off, interrupt
- 2 Resume speed
- 3 Store speed\*
- 4 Reduce distance
- 5 Store, maintain/change speed
- 6 Increase distance

### Switching on/off and interrupting cruise control

#### Switching on



Press the button on the steering wheel.

The indicator lamps in the instrument cluster light up and the marking in the speedometer is set to the current speed.

Cruise control can be used.

#### Switching off



Deactivated or interrupted system

If the system is deactivated or interrupted, actively intervene by braking and, if necessary, with evasive maneuvers; otherwise, there is the danger of an accident occurring. ◀

If switching off the system while stationary, press on the brake pedal at the same time.



Press the button.

- ▶ If active: press twice.
- ▶ If interrupted: press once.

The displays go out. The stored desired speed and distance are deleted.

## Interrupting

I/O

When active, press the button.

If interrupting the system while stationary, press on the brake pedal at the same time.

The system is automatically interrupted if:

- ▷ The brakes are applied.
- ▷ The clutch pedal is depressed.
- ▷ Transmission position D is disengaged.
- ▷ DTC Dynamic Traction Control is activated or DSC is deactivated.
- ▷ DSC is actively controlling stability.
- ▷ The safety belt and the driver's door are opened when the vehicle is standing.
- ▷ The system has not detected objects for an extended period, e.g., on a road with very little traffic without road edge line markings.
- ▷ Radar sensor is soiled.

## Maintaining/storing the speed

SET

Press the button\*.

When the system is switched on, the current speed is maintained and stored as the desired speed.

It is displayed in the speedometer and briefly displayed in the instrument cluster. Displays in the instrument cluster, refer to page 108.

When cruise control is maintained or stored, DSC Dynamic Stability Control is switched on, if necessary.

## Changing, maintaining, and storing the speed

The rocker switch can be pressed while the system is interrupted to maintain and store the current speed. DSC Dynamic Stability Control is switched on, if necessary.



### Adapting the desired speed

Adapt the desired speed to the road conditions and be ready to brake at all times; otherwise, there is the danger of an accident occurring. ◀



### Speed differences

Great speed differences with vehicles driving ahead of you, e.g., when rapidly approaching a truck or when another vehicle swerves into your own lane, cannot be compensated for by the system. ◀

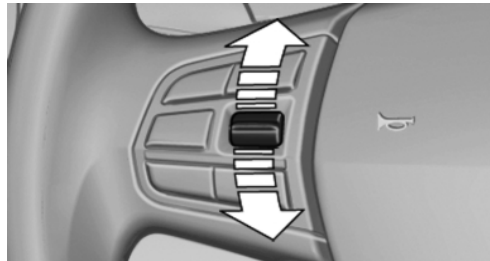

Press the rocker switch up or down repeatedly until the desired speed is set.

If active, the displayed speed is stored and the vehicle reaches the stored speed if the road is clear.

- ▷ Each time the rocker switch is pressed to the point of resistance, the desired speed increases or decreases by approx. 1 mph/ 1 km/h.
- ▷ Each time the rocker switch is pressed past the point of resistance, the desired speed increases or decreases by a maximum of 5 mph/10 km/h. max. adjustable speed: 110 mph/180 km/h.

Hold the rocker switch in position to repeat the action.

## Distance



### Selecting a distance

Adjust the distance according to the traffic and weather conditions; otherwise, there is the danger of an accident occurring. Maintain the prescribed safety distance. ◀

### Reduce distance

 Press the button repeatedly until the desired distance is set.

The selected distance, refer to page 109, is displayed in the instrument cluster.

### Increase distance

 Press the button repeatedly until the desired distance is set.

The selected distance, refer to page 109, is displayed in the instrument cluster.

### Calling up the desired speed and distance

#### While driving

 Press the button with the system switched on.

In the following cases, the stored speed value is deleted and cannot be called up again:

- ▷ When the system is switched off.
- ▷ When the ignition is switched off.

#### While standing

 Before leaving the vehicle, secure it against rolling.

Before leaving the vehicle with the engine running, engage position P of the automatic transmission and apply the parking brake. Otherwise, the vehicle may begin to roll. ◀

The system brought the vehicle to a complete standstill.

- ▷ Green mark in the speedometer during a brief idle phase:  
The vehicle ahead of you drives away while the mark is green: your vehicle accelerates without anything having to be done.
- ▷ Switch to orange of the mark in the speedometer after approx. 2 sec.:

The vehicle ahead of you drives away, while the mark is orange: in order to accelerate, briefly press the accelerator or press the RES button or SET button.

Rolling bars in the distance indicator mean that the vehicle ahead of you has driven off.

You actively braked your vehicle to a halt by pressing on the brake pedal and it is standing behind another vehicle:

1.  Press the button to call up a stored desired speed.
2. Release the brake pedal.
3. Press on the accelerator briefly, or press the RES button or the rocker switch when the vehicle ahead of you drives away.

### Displays in the instrument cluster

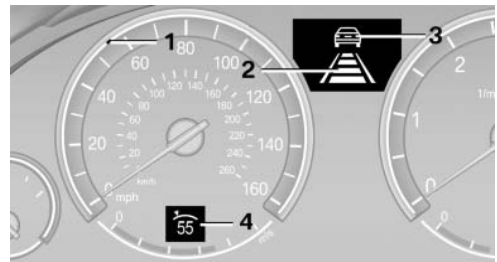

- 1 Display of desired speed
- 2 Distance to vehicle ahead of you
- 3 Vehicle symbol
- 4 Brief status display

### Desired speed

#### Marking in the speedometer



- ▷ The marking lights up in green: the system is active.
- ▷ The marking lights up in orange: the system has been interrupted.
- ▷ The marking does not light up: the system is switched off.

#### Brief status display

 Selected desired speed.

If --- appears briefly on the display for Check Control messages, it is possible that the system



requirements for operation are currently not met.

## Distance to vehicle ahead of you

The selected distance to the vehicle driving ahead of you is shown.

### Distance display



Distance 1



Distance 2



Distance 3



Distance 4

This value is set after the system is switched on.



The system has been interrupted or distance control is deactivated because the accelerator is being pressed; a vehicle was not detected.



Distance control is deactivated because the accelerator is being pressed; a vehicle was detected.

Rolling bars: the detected vehicle has driven away.

## Indicator/warning lamps



Personal responsibility

The indicator and warning lamps do not relieve the driver of the responsibility to adapt his or her desired driving speed and style to the traffic conditions. ◀



The vehicle symbol lights up in orange:  
A vehicle has been detected ahead of you.



The vehicle symbol flashes orange:  
The conditions are not adequate for operating the system.

The system was deactivated but applies the brakes until you actively assume control by pressing on the brake pedal or accelerator.



The vehicle symbol flashes red and an acoustic signal sounds:

You are requested to intervene by braking or making an evasive maneuver.

## System limits

### Speed range

Best results are achieved when using the system on well-developed roads and highways. The desired speed can be selected between 20 mph/30 km/h to 110 mph/180 km/h.

The system can also be activated when stationary.

Comply with the legal speed limit in every situation when using the system.

### Detection range

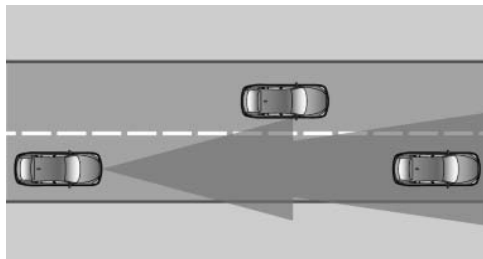

The detection capacity of the system and the automatic braking capacity are limited.

Two-wheeled vehicles driving ahead of you for instance might not be detected.



Limited detection capacity

Because of the limits to the detection capacity, you should be alert at all times so that you can intervene actively, if necessary; otherwise, there is the danger of an accident occurring. ◀

### Deceleration

The system does not decelerate when a stationary obstacle is located in the same lane, e.g.,

a vehicle at a red traffic light or at the end of traffic congestion.

The system also does not respond to:

- ▷ Pedestrians or similarly slow road users.
- ▷ Red traffic lights.
- ▷ Stationary objects.
- ▷ Cross traffic.
- ▷ Approaching traffic.



No warnings

A warning may not be issued when approaching a stationary or very slow-moving obstacle. You must react yourself; otherwise, there is the danger of an accident occurring. ◀

## Swerving vehicles

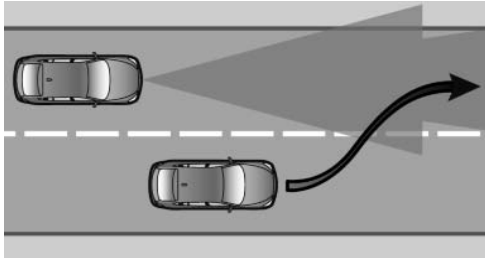

A vehicle driving in front of you is not detected until it is completely within the same lane as your vehicle.



Swerving vehicles

If a vehicle driving ahead of you suddenly swerves into your lane, the system may not be able to automatically restore the selected distance. This also applies to major speed differences to vehicles driving ahead of you, e.g., when rapidly approaching a truck. When a vehicle driving ahead of you is reliably detected, the system requests that the driver intervene by braking and carrying out evasive maneuvers, if necessary. You must react yourself; otherwise, there is the danger of an accident occurring. ◀

## Unexpected lane change

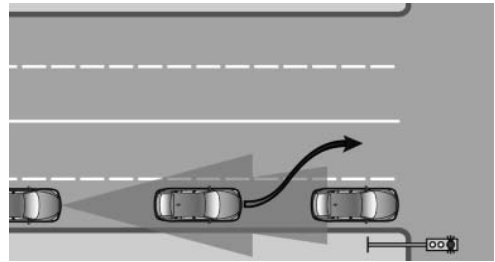

If a vehicle ahead of you unexpectedly moves into another lane from behind a stopped vehicle, you yourself must react, as the system does not react to stopped vehicles.

## Cornering



If the desired speed is too high for a curve, the speed is reduced slightly in the curve, although curves cannot be anticipated in advance. Therefore, drive into a curve at an appropriate speed.

In tight curves, situations may result due to the restricted detection range of the system in which a vehicle driving ahead of you may not be detected at all, or not until after a considerable delay.

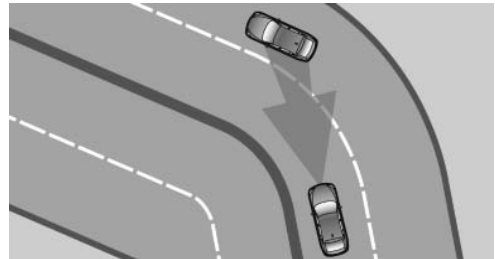

When approaching a curve, the system may react briefly to the vehicles in the next lane due to

the bend of the curve. Any deceleration of the vehicle by the system can be compensated for by briefly accelerating. After the accelerator pedal is released, the system becomes active again and independently controls the speed.

## Driving away

In some situations, the vehicle cannot drive away automatically, e.g., on steep inclines or behind bumps in the road.

## Radar sensor

### Position

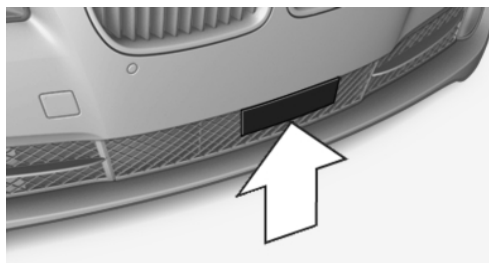

Radar sensor

### Dirty or covered sensor

A dirty or covered sensor may hinder the detection of vehicles.

- ▶ If necessary, clean the radar sensor. Remove layers of snow and ice carefully.
- ▶ Do not cover the view field of the radar sensor.

### Malfunction

The system cannot be activated if the sensor is not aligned correctly. This may be caused by damage incurred during parking, for example.

A Check Control message is displayed if the system fails.

### For US owners only

The transmitter and receiver units comply with part 15 of the FCC/Federal Communication Commission regulations. Operation is governed by the following:

FCC ID:

- ▶ OAYARS3-A

Compliance statement:

This device complies with part 15 of the FCC Rules. Operation is subject to the following two conditions:

- ▶ This device may not cause harmful interference, and
- ▶ this device must accept any interference received, including interference that may cause undesired operation.

Any unauthorized modifications or changes to these devices could void the user's authority to operate this equipment.

### Note

To reduce electromagnetic effects, please use properly.

The standard SAR value is 2.0 W/kg; the tested value of this product is 0.751 W/kg.

NCC declaration:

1. Companies or persons without authorization should not change the frequency, increase the power, or change the characteristics or functions of the original design of low-power radio frequency devices with type approval.
2. Low-power radio frequency devices should not impair legal communication or flight safety. If this type of impairment is detected, the device should be switched off immediately. In this case, please contact the manufacturer and only use the product after the problem has been corrected.
3. The "legal communication" specified above refers to communication in accordance with telecommunication regulations. Low-power devices should withstand interference from legal communication and ISM devices.

## Collision warning with braking function\*

### The concept

The system issues a two-phase warning of a danger of collision at speeds above approx. 10 mph/15 km/h.

The collision warning is available even if cruise control has been deactivated.

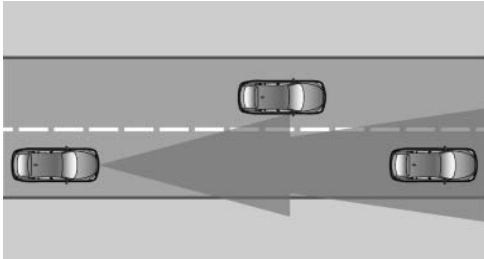

It responds to stationary or moving objects that are within the detection range of the radar system.

When the vehicle is intentionally brought into contact with an object, the collision warning is delayed to avoid false warnings.

### Warning stages

#### Prewarning

This warning is issued, for example, when there is the impending danger of a collision or the distance to the vehicle ahead is too small.

#### Acute warning with braking function

Warning of the imminent danger of a collision when the vehicle approaches another object at a relatively high differential speed.

The acute warning prompts the driver to intervene and, if there is the danger of a collision, is accompanied by a braking intervention.

The braking intervention is executed with limited braking force and for a brief period only. The intervention cannot bring the vehicle to a complete standstill.

The braking intervention is executed only if DSC Dynamic Stability Control, refer to page 99, is switched on.



Adapting your speed and driving style

The acute warning does not relieve the driver of the responsibility to adapt his or her driving speed and style to the traffic conditions. ◀

The braking intervention can be interrupted by pressing on the accelerator or by actively moving the steering wheel.

When towing or tow-starting the vehicle, switch off the collision warning with braking function to prevent undesired interventions.

The braking function is deactivated if the DSC Dynamic Stability Control or DTC Dynamic Traction Control is deactivated.

### Switching the warning function on/off



Press the button

- ▷ On: the LED lights up.
- ▷ Off: the LED goes out.

The state is stored for the remote control currently in use.

### Configuring the prewarning

After the warning function is switched on, the following can be set via the iDrive:

- ▷ The prewarning can be switched on/off.
- ▷ The time of the prewarning can be set.

These settings have no effect on the time of the warning from the Active Cruise Control\* that prompts the driver to intervene or brake.

## Display

The collision warning can be issued in the instrument cluster, in the Head-up Display\*, and acoustically.

## Instrument cluster



The vehicle lights up in red: prewarning



The vehicle flashes red and an acoustic signal sounds: acute warning

You are requested to intervene by braking or making an evasive maneuver.



Adapting your speed and driving style

The display does not relieve the driver of the responsibility to adapt his or her driving speed and style to the traffic conditions. ◀

## System limits



Be alert

Due to system limitations, warnings may be not be issued at all, or may be issued late or improperly. Therefore, always be alert and ready to intervene; otherwise, there is the danger of an accident occurring. ◀

## Detection range

The detection capacity of the radar sensor and the collision warning has limitations.

This may result in the warning not being issued or being issued late.

For example, the following situations may not be detected:

- ▶ Slow moving objects when you approach them at high speed.
- ▶ Vehicles that suddenly swerve in front of your vehicle.
- ▶ Two-wheeled vehicles ahead of you.
- ▶ Pedestrians.

## Functional limitations

The system may not be fully functional in the following situations:

- ▶ In heavy fog, rain or snowfall.
- ▶ In tight curves.
- ▶ If the radar sensor is dirty or covered.

## Prewarning sensitivity

If the prewarning setting is too sensitive, there may be an excess of false warnings.

## Cruise control

### The concept

The system is functional at speeds beginning at approx. 20 mph/30 km/h.

It maintains the speed that was set using the control elements on the steering wheel.

The system brakes on downhill gradients if engine braking action is insufficient.



Unfavorable conditions

Do not use the system if unfavorable conditions make it impossible to drive at a constant speed, for instance:

- ▶ On curvy roads.
- ▶ In heavy traffic.
- ▶ On slippery roads, in fog, snow or rain, or on a loose road surface.

Otherwise, you could lose control of the vehicle and cause an accident. ◀

## Controls

### Buttons at a glance



- 1 System on/off, interrupt
- 2 Resume speed

- 3 Store speed\*
- 4 Store, maintain/change speed

### Switching on

 Press the button on the steering wheel.

The marking in the speedometer is set to the current speed.

Cruise control can be used.

### Switching off

 Deactivated or interrupted system  
If the system is deactivated or interrupted, actively intervene by braking and, if necessary, with evasive maneuvers; otherwise, there is the danger of an accident occurring. ◀

 Press the button.

- ▷ If active: press twice.
- ▷ If interrupted: press once.

The displays go out. The stored desired speed is deleted.

### Interrupting

 When active, press the button.

The system is automatically interrupted if:

- ▷ The brakes are applied.
- ▷ The clutch pedal is depressed.
- ▷ Transmission position D is disengaged.
- ▷ DTC Dynamic Traction Control is activated or DSC is deactivated.
- ▷ DSC is actively controlling stability.
- ▷ HDC is activated.

### Maintaining/storing the current speed

 Press the button.

When the system is switched on, the current speed is maintained and stored as the desired speed.

It is displayed in the speedometer and briefly displayed in the instrument cluster. Displays in the speedometer, refer to page 115.

When cruise control is maintained or stored, DSC Dynamic Stability Control is switched on, if necessary.

### Change, maintain speed

The rocker switch can be pressed while interrupted to maintain and store the current speed.

 Adapting the desired speed  
Adapt the desired speed to the road conditions and be ready to brake at all times; otherwise, there is the danger of an accident occurring. ◀

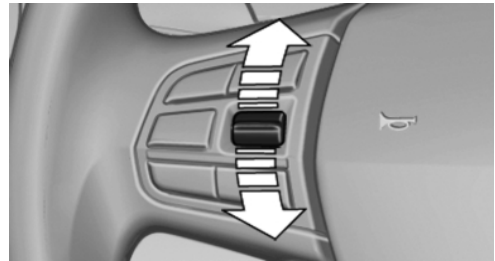

Press the rocker switch up or down repeatedly until the desired speed is set.

If active, the displayed speed is stored and the vehicle reaches the stored speed if the road is clear.

- ▷ Each time the rocker switch is pressed to the point of resistance, the desired speed increases or decreases by approx. 1 mph/ 1 km/h.
- ▷ Each time the rocker switch is pressed past the point of resistance, the desired speed increases or decreases by a maximum of 5 mph/10 km/h.
- ▷ Pressing the rocker switch to the resistance point and holding it accelerates or decelerates the vehicle without requiring pressure on the accelerator. After the rocker switch is released, the vehicle maintains its final speed. Pressing the switch beyond the resistance point causes the vehicle to accelerate more rapidly.

## Resuming the desired speed

RES

Press the button.

The stored speed is reached and maintained.

## Displays in the instrument cluster

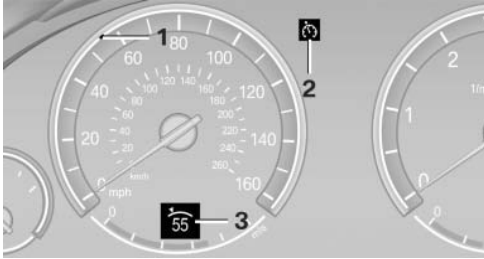

- 1 Display of desired speed
- 2 Indicator lamp
- 3 Brief status display

## Desired speed

Display in the speedometer:



- ▶ The marking lights up in green: the system is active.
- ▶ The marking lights up in orange: the system has been interrupted.
- ▶ The marking does not light up: the system is switched off.

## Brief status display

Brief display in the speedometer:



Selected desired speed

If --- appears briefly, conditions may not be adequate to operate the system.

## PDC Park Distance Control\*

### The concept

In addition to the PDC Park Distance Control, the backup camera\*, refer to page 119, can be switched on.

PDC supports you when parking. Objects that you are approaching slowly in front of\* or behind your vehicle are indicated with:

- ▶ Signal tones.
- ▶ Visual display.

## Measurement

Measurements are made by ultrasound sensors in the bumpers.

The range is approx. 6 ft/2 m.

An acoustic warning is first given:

- ▶ By the front\* sensors and the two rear corner sensors at approx. 24 in/60 cm.
- ▶ By the rear middle sensors at approx. 5 ft/1.50 m.

## System limits



Check the traffic situation as well

PDC cannot serve as a substitute for the driver's personal judgment of the traffic situation. Check the traffic situation around the vehicle with your own eyes. Otherwise, an accident could result from road users or objects located outside of the PDC detection range.

Loud noises from outside and inside the vehicle may prevent you from hearing the PDC's signal tone. ◀



Avoid driving quickly with PDC

Avoid approaching an object quickly.

Avoid driving away quickly while PDC is not yet active.

For technical reasons, the system may otherwise be too late in issuing a warning. ◀

## Limits of ultrasonic measurement

The detection of objects can reach the physical limits of ultrasonic measurement, for instance:

- ▶ With tow bars and trailer hitches.
- ▶ With thin or wedge-shaped objects.
- ▶ With low objects.
- ▶ With objects with corners and sharp edges.



Low objects already displayed, e.g., curbs, can move into the blind area of the sensors before or after a continuous tone sounds.

High, protruding objects such as ledges may not be detected.

### False warnings

PDC may issue a warning under the following conditions even though there is no obstacle within the detection range:

- ▷ In heavy rain.
- ▷ When sensors are very dirty or covered in ice.
- ▷ When sensors are covered in snow.
- ▷ On rough road surfaces.
- ▷ In large buildings with right angles and smooth walls, e.g., in underground garages.
- ▷ In heavy exhaust.
- ▷ Due to other ultrasound sources, e.g., sweeping machines, high pressure steam cleaners or neon lights.

### Switching on automatically

Select transmission position R with the engine running.

### Switching off automatically

The system switches off and the LED goes out:

- ▷ After approx. 160 ft/50 m when driving forward.
- ▷ Above approx. 22 mph/36 km/h when driving forward.

Switch on the system again if necessary.

### Switching on/off manually



Press the button.

- ▷ On: the LED lights up.
- ▷ Off: the LED goes out.

### Signal tones

When approaching an object, an intermittent tone is sounded that indicates the position of the object. For example, if an object is detected to the left rear of the vehicle, a signal tone sounds from the left rear speaker.

The shorter the distance to the object becomes, the shorter the intervals.

If the distance to a detected object is less than approx. 12 in/30 cm, a continuous tone is sounded.

If objects are located both in front of and behind the vehicle, an alternating continuous signal is sounded.

The intermittent tone is interrupted after approx. 3 seconds:

- ▷ If the vehicle stops in front of an object that is detected by only one of the corner sensors.
- ▷ If moving parallel to a wall.

The signal tone is switched off:

- ▷ When the vehicle moves away from an object by more than approx. 4 in/10 cm.
- ▷ When transmission position P is engaged.

### Volume

You can set the volume of the PDC signal tone, refer to page 173.

The setting is stored for the remote control currently in use.

### Visual warning

The approach of the vehicle to an object can be shown on the Control Display. Objects that are farther away are displayed on the Control Display before a signal tone sounds.

A display appears as soon as Park Distance Control (PDC) is activated.



If the backup camera image was selected last, it again appears on the display. To switch to PDC:

1.  "Rear view camera" Select the symbol on the Control Display.
2. Press the controller.

The setting is stored for the remote control currently in use.

### Zoom view\*

On the left part of the display screen, the vehicle is shown enlarged.

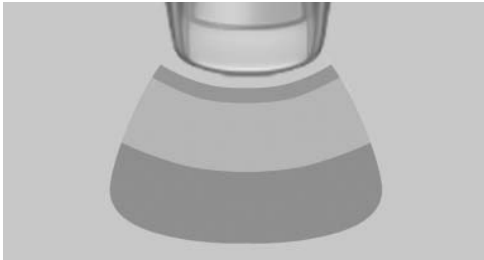

- ▷ Transmission position D engaged: front area of the vehicle.
- ▷ Transmission position R engaged: rear area of the vehicle.

### Display on the Control Display

#### Switching on the backup camera via the iDrive

With PDC activated:

 "Rear view camera"

The backup camera image is displayed. The setting is stored for the remote control currently in use.

### Malfunction

A Check Control message is displayed.

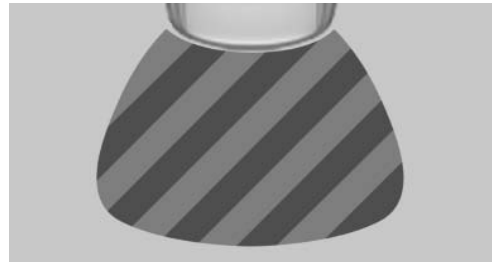

On the Control Display, the areas in front of and behind the vehicle are shaded. PDC has failed. Have the system checked.

To ensure full operability:

- ▷ Keep the sensors clean and free of ice.
- ▷ When using a pressure washer, keep the sprayer moving and maintain a distance of at least 12 in/30 cm from the sensors.

### Surround View\*

#### The concept

Surround View includes the following systems:

- ▷ Backup camera, refer to page 119.
- ▷ Side View, refer to page 121.
- ▷ Top View, refer to page 117.

It assists the driver when parking, maneuvering and on blind driveways and intersections.

### Top View\*

#### The concept

Top View assists you in parking and maneuvering. The area around the doors and the road area around the vehicle are shown on the Control Display for this purpose.

#### Capturing the image

The image is captured by two cameras integrated in the exterior mirrors and by the backup camera.

The range equals:

- ▷ approx. 10 ft/3 m to the side.

- ▷ approx. 7 ft/2 m to the rear.

In this way, obstacles up to the height of the exterior mirrors are detected early.

### System limits

Top View cannot be used in the following situations:

- ▷ With a door open.
- ▷ With the tailgate open.
- ▷ With an exterior mirror folded in.
- ▷ In poor light.

A Check Control message is displayed in some of these situations.



Check the traffic situation as well

Check the traffic situation around the vehicle with your own eyes. Otherwise, an accident could result from road users or objects located outside the picture area of the cameras. ◀

### Switching on automatically

Select transmission position R with the engine running.

The Top View and PDC images are displayed if the system is switched on via iDrive.

### Switching off automatically

The system switches off and the LED goes out:

- ▷ After approx. 160 ft/50 m when driving forward.
- ▷ Above approx. 22 mph/36 km/h when driving forward.

Switch on the system again if necessary.

### Switching on/off manually



Press the button.

- ▷ On: the LED lights up.
- ▷ Off: the LED goes out.

If Top View is displayed, switch on the backup camera via the iDrive, refer to page 118.

### Visual warning

The approach of the vehicle to an object can be shown on the Control Display.

When the distance to an object is small, a red bar is shown in front of the vehicle, as it is in the PDC display.

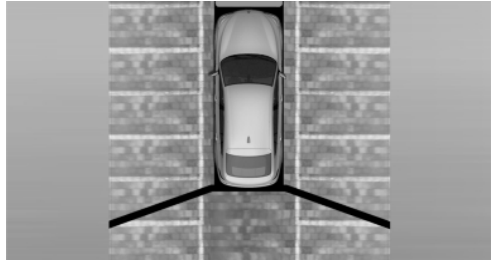

The display appears as soon as Top View is activated.

If the backup camera image was selected last, it again appears on the display. To switch to Top View:

**R** "Rear view camera" Select the symbol on the Control Display.

The setting is stored for the remote control currently in use.

### Display on the Control Display

#### Switching on the backup camera via iDrive

With Top View switched on:

**R** "Rear view camera"

The backup camera image is displayed. The setting is stored for the remote control currently in use.

#### Brightness

With Top View switched on:

1. ☀ "Brightness"
2. Turn the controller until the desired setting is reached and press the controller.

## Contrast

With Top View switched on:

1. ● "Contrast"
2. Turn the controller until the desired setting is reached and press the controller.

## Displaying the turning circle and pathway lines

- ▷ The static, red turning circle line shows the space needed to the side of the vehicle when the steering wheel is turned all the way.
- ▷ The variable, green pathway line assists you in assessing the amount of space actually needed to the side of the vehicle.

The pathway line is dependent on the current steering angle and is continuously adjusted with the steering wheel movement.

### "Parking aid lines"

Turning circle and pathway lines are displayed.

## Cameras

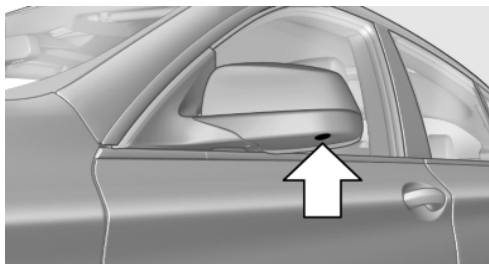



The objectives of the Top View cameras are located at the bottom of the exterior mirror housings. The image quality may be impaired by dirt. Clean the lens, refer to page 271.

## Backup camera\*

### The concept

The backup camera provides assistance in parking and maneuvering backwards. The area behind the vehicle is shown on the Control Display.

### System limits

-  Check the traffic situation as well  
Check the traffic situation around the vehicle with your own eyes. Otherwise, an accident could result from road users or objects located outside the picture area of the backup camera. ◀
-  Detection of objects  
High, protruding objects such as ledges may not be detected by the backup camera. ◀

### Switching on automatically

Select transmission position R with the engine running.

The backup camera image is displayed if the system was switched on via the iDrive.

### Switching off automatically

The system switches off and the LED goes out:

- ▷ After approx. 33 ft/10 m when driving forward.
- ▷ Above approx. 9 mph/15 km/h when driving forward.

Switch on the system again if necessary.

### Switching on/off manually



-  Press the button.

- ▷ On: the LED lights up.
- ▷ Off: the LED goes out.

The PDC is shown on the Control Display.

Switch on the backup camera via the iDrive, refer to page 121.

## Assistance functions

### Functional requirement

- ▷ The backup camera is switched on.
- ▷ The tailgate is fully closed.

### Pathway lines

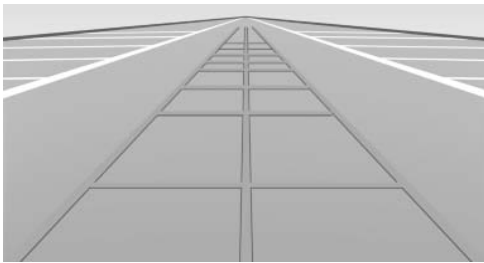

- ▷ Can be shown in the backup camera image when in transmission position R.
- ▷ Help you to estimate the space required when parking and maneuvering on level roads.
- ▷ Are dependent on the current steering angle and are continuously adjusted to the steering wheel movements.

Show the parking aid lines, refer to page 121.

### Turning circle lines



- ▷ Can be shown in the backup camera image.

- ▷ Show the course of the smallest possible turning circle on a level road.
- ▷ Only one turning circle line is displayed when the steering wheel is turned.

Show the parking aid lines, refer to page 121.

### Parking using pathway and turning circle lines

1. Position the vehicle so that the turning circle lines lead to within the limits of the parking space.

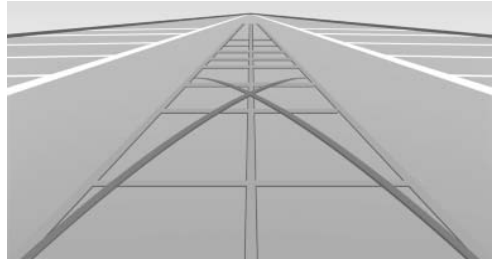

2. Turn the steering wheel to the point where the pathway line covers the corresponding turning circle line.

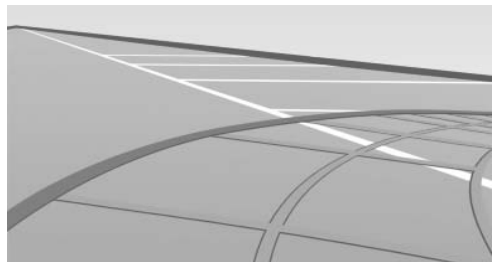

### Obstacle marking

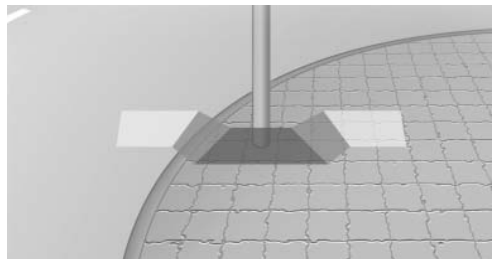

- ▷ Spatially-shaped markings can be shown in the backup camera image.

Their colored steps match the markings of the PDC. This simplifies estimation of the distance to the object shown.

## Activating the assistance functions

More than one assistance function can be active at the same time.

### Showing the parking aid lines

 "Parking aid lines"

Pathway and turning circle lines are displayed.

### Showing the obstacle marking

 "Obstacle marking"

Spatially-shaped markings are displayed.

## Display on the Control Display

### Switching on the backup camera via iDrive

With PDC activated:

 "Rear view camera"

The backup camera image is displayed. The setting is stored for the remote control currently in use.

### Brightness

With the backup camera switched on:

-  Select the symbol.
- Turn the controller until the desired setting is reached and press the controller.

### Contrast

With the backup camera switched on:

-  Select the symbol.
- Turn the controller until the desired setting is reached and press the controller.

## Camera

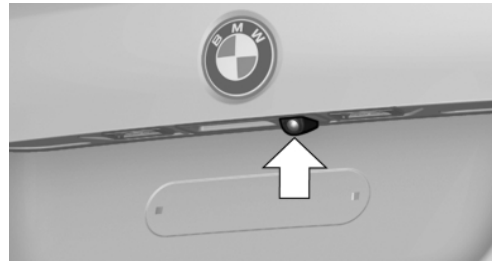

The camera lens is located in the handle of the tailgate. The image quality may be impaired by dirt.

Clean the lens, refer to page 271.

## Side View\*

### The concept

Side View provides an early look at cross traffic at blind driveways and intersections. Road users concealed by obstacles to the left and right of the vehicle can only be detected relatively late from the driver's seat. To improve visibility, two cameras in the front of the vehicle record the traffic situation on each side.

### System limits

The maximum recording range of the camera is 330 ft/100 m.

### Display

The images from both cameras are shown simultaneously on the Control Display.



Check the traffic situation as well

Check the traffic situation around the vehicle on blind driveways and intersections with your own eyes. Otherwise, an accident could result from road users or objects located outside the picture area of the Side View cameras. ◀

### Switching off automatically

System switches off: above approx. 9 mph/ 15 km/h.

Switch on the system again if necessary.

### Switching on/off manually



Press the button.

### Display on the Control Display

The traffic area to the left and right is displayed on the Control Display.

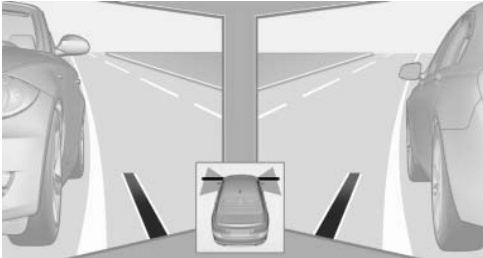

Guidelines at the bottom of the image show the position of the front of the vehicle.

### Brightness

With the Side View switched on:

1. ☀ "Brightness"
2. Turn the controller until the desired setting is reached and press the controller.

### Contrast

With the Side View switched on:

1. ● "Contrast"
2. Turn the controller until the desired setting is reached and press the controller.

### Cameras

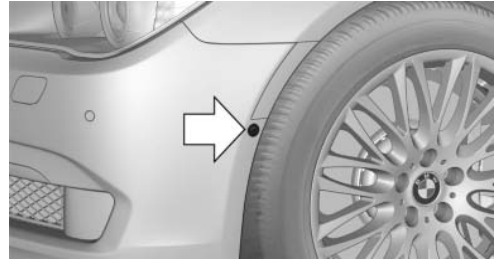

The two camera lenses are located on the sides of the bumper.

The image quality may be impaired by dirt.

Clean the lens, refer to page 271.

### Night Vision with pedestrian detection\*

#### The concept

Night Vision with pedestrian detection is a night vision system.

An infrared camera records the area in front of the vehicle and displays the image on the Control Display.

The picture is a heat image. The system has an integrated pedestrian detection function that detects pedestrians and cyclists. Warm objects that are similar in shape to human beings are detected by the system.



#### Personal responsibility

Night Vision cannot replace the driver's personal judgment of the visibility conditions and the traffic situation. The view ahead and the actual visibility conditions must always be the basis on which the vehicle speed is adjusted; otherwise, there is a risk to road safety. ◀

## Heat image

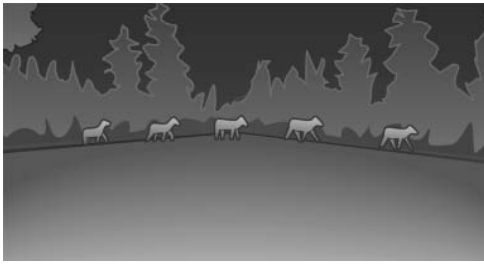

The image shows the heat radiated by objects in the field of view of the camera.

Warm objects have a light appearance and cold objects, a dark appearance.

The ability to detect an object depends on the temperature difference between the object and the background and on the level of heat radiation emitted by the object. Objects that are similar in temperature to the environment or that radiate very little heat are difficult to detect.

For safety reasons, when driving at speeds above approx. 3 mph/5 km/h and in low ambient light, the image is only displayed when the low beams are switched on.

A still image is displayed at regular intervals for a fraction of a second.

## Pedestrian detection



The pedestrian detection and warning system only operates in darkness and only when a heat image is displayed.

Warm objects that are similar in shape to human beings are detected by the system.

People detected by the system are displayed with a slight yellow hue.

Under good ambient conditions, the pedestrian detection system operates within a range of approx. 50 ft/15 m to approx. 330 ft/100 m.



Environmental influences can limit the availability of pedestrian detection.

If pedestrian detection is not available, a symbol is displayed in the heat image.

This symbol disappears when the function becomes available again.

## Warning of people in danger



If the system detects a person in the defined danger area in front of the vehicle and if there is the danger of a collision with this person, a warning symbol appears in the Control Display and Head-up Display\*.

Although both the shape and the heat radiation are analyzed, false warnings cannot be ruled out.



## Warning area in front of the vehicle

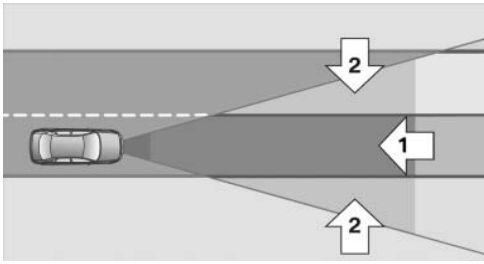

The warning area in front of the vehicle is divided into two areas.

- ▷ Central area 1 directly in front of the vehicle.
- ▷ Expanded area 2 to the right and left.

The entire area moves along with the vehicle in the direction of the steering angle and changes with the vehicle speed. As the vehicle speed increases, the area becomes longer and wider, for example.

### Symbols



This symbol is displayed when a person is detected in the central area, arrow 1, immediately in front of the vehicle.



This symbol is displayed when a person detected in the extended area, arrow 2, is moving from the right or left to the central area.

### Display in the Head-up Display\*



The warning is simultaneously displayed in the Head-up Display and in the Control Display. The displayed symbol can vary with the people detected. For people located in the central area, the distance to the person is indicated by the size of the symbol.

## System limits

### Basic limits

System operation is limited in situations such as the following:

- ▷ On steep hills, in steep depressions or in tight curves.

- ▷ When the camera is dirty or the protective glass is damaged.
- ▷ In heavy fog, rain or snowfall.
- ▷ At very high external temperatures.

### Limits of pedestrian detection

Animals are not detected by the pedestrian detection function, even if they are clearly visible in the image.

Limited pedestrian detection:

- ▷ When people are fully or partially covered, especially when their heads are covered.
- ▷ When people are not in an upright position, e.g., when lying down.
- ▷ Cyclists on unconventional bicycles (e.g., recumbent bicycles).
- ▷ After physical damage to the system, e.g., after an accident.

### Activation/deactivation



Press the button.

### Display

Night Vision with pedestrian detection is not available on the rear screen\*.

### Settings via iDrive

With Night Vision switched on:

1. Activate Night Vision with pedestrian detection.
2. Press the controller.
3. Open the desired menu item.
  - ▷ ☀ "Brightness"



- ▷  "Contrast"
- ▷  "Pedestrian detection"

The settings are stored for the remote control currently in use.

## Camera

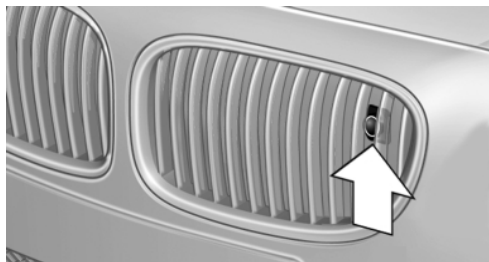

Rain, dirt, snow, or ice can impair camera operation.

The camera is automatically heated when the external temperatures are low.

The camera is automatically cleaned together with the headlamps.

Clean the lens, refer to page 271.

## Head-up Display\*

### The concept

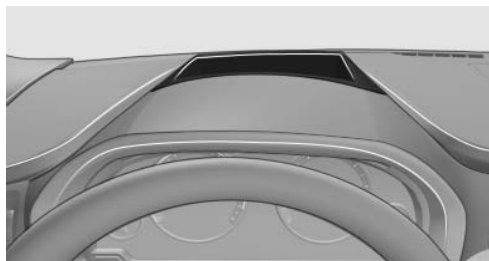

This system projects important information into the driver's field of vision, e.g., the speed.

In this way, the driver can get information without averting his or her eyes from the road.

### Display visibility

The visibility of the displays in the Head-up Display is influenced by:

- ▷ Certain sitting positions.
- ▷ Objects on the cover of the Head-up Display.
- ▷ Sunglasses with certain polarization filters.
- ▷ Wet roads.
- ▷ Unfavorable light conditions.

If the image is distorted, check the basic settings.

### Switching on/off



Press the button.

### Display

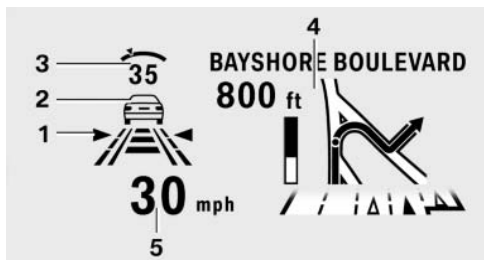

- 1 Lane departure warning\*
- 2 Active Cruise Control\*
- 3 Desired speed
- 4 Navigation system\*
- 5 Speed

The collision warning\*, Night Vision\* pedestrian warning, or Check Control messages are displayed briefly if needed.

## Selecting displays in the Head-up Display

1. "Settings"
2. "Head-up display"
3. "Displayed information"
4. Select the desired displays in the Head-up Display.

The settings are stored for the remote control currently in use.

## Setting the brightness

The brightness is automatically adjusted to the ambient light.

The basic setting can be adjusted manually.

1. "Settings"
2. "Head-up display"
3. "Brightness"
4. Turn the controller.

The brightness is adjusted.

When the low beams are switched on, the brightness of the Head-up Display can be additionally influenced using the instrument lighting, refer to page [88](#).

The setting is stored for the remote control currently in use.

## Adjusting the height

1. "Settings"
2. "Head-up display"
3. "Height"
4. Turn the controller.

The height is adjusted.

The setting is stored for the remote control currently in use.

## Special windshield

The windshield is part of the system.

The shape of the windshield makes it possible to display a precise image.

A film in the windshield prevents double images from being displayed.

Therefore, have the special windshield replaced by a service center only.

# Climate control

## Automatic climate control\*

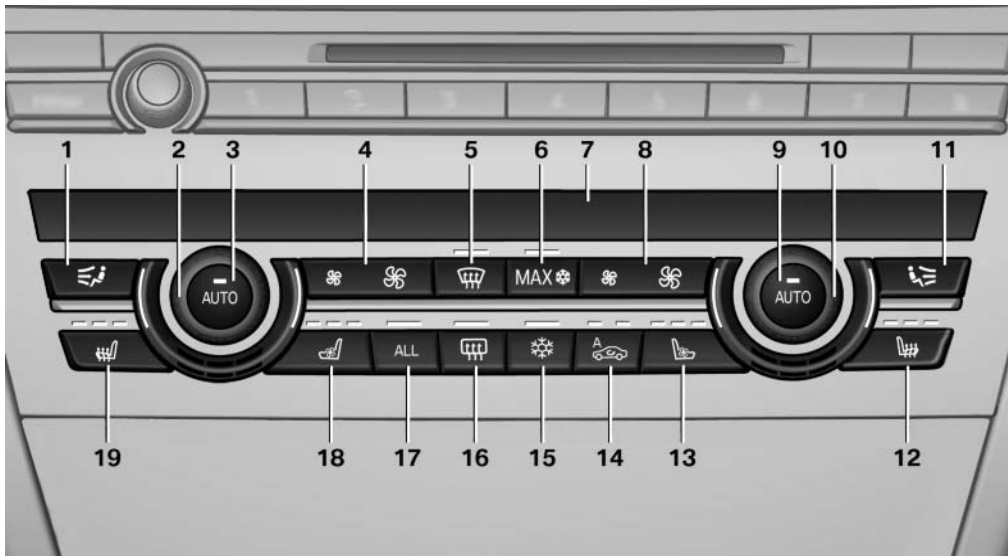

- |   |   |
|---|---|
| 1 Air distribution, left                          | 11 Air distribution, right                                  |
| 2 Temperature, left                               | 12 Seat heating*, right <a href="#">52</a>                  |
| 3 AUTO program, left                              | 13 Active seat ventilation*, right <a href="#">52</a>       |
| 4 Air volume, AUTO intensity, residual heat, left | 14 Automatic recirculated-air control/recirculated-air mode |
| 5 Remove ice and condensation                     | 15 Cooling function   |
| 6 Maximum cooling                                 | 16 Rear window defroster                                    |
| 7 Display   | 17 ALL program  |
| 8 Air volume, AUTO intensity, right               | 18 Active seat ventilation*, left <a href="#">52</a>        |
| 9 AUTO program, right                             | 19 Seat heating*, left <a href="#">52</a>                   |
| 10 Temperature, right                             |   |

### Climate control functions in detail

#### Manual air distribution

 Press the button repeatedly to select a program:

- ▷ Upper body region.
- ▷ Upper body region and footwell.

- ▷ Footwell.
- ▷ Windows and footwell: driver's side only.
- ▷ Windows, upper body region and footwell: driver's side only.

If the windows are fogged over, press the AUTO button on the driver's side to utilize the condensation sensor.

## Temperature



Turn the wheel to set the desired temperature.

The automatic climate control achieves this temperature as quickly as possible, if necessary with the maximum cooling or heating capacity, and then keeps it constant.

Avoid rapidly switching between different temperature settings. The automatic climate control will not have sufficient time to adjust the set temperature.

## AUTO program



Press the button.

Air volume, air distribution, and temperature are controlled automatically.

Depending on the selected temperature, AUTO intensity, and outside influences, the air is directed to the windshield, side windows, upper body, and into the footwell.

The cooling function, refer to page 129, is switched on automatically with the AUTO program.

At the same time, a condensation sensor controls the program so as to prevent window condensation as much as possible.

## Intensity of the AUTO program

With the AUTO program switched on, automatic control of the air volume and air distribution can be adjusted.



Press the left or right side of the button: decrease or increase the intensity.

The selected intensity is shown on the display of the automatic climate control.

## Air volume, manual

To be able to manually adjust the air volume, switch off the AUTO program first.



Press the left or right side of the button: decrease or increase air volume.

The selected air volume is shown on the display of the automatic climate control.

The air volume of the automatic climate control may be reduced automatically to save battery power.

## Defrosting windows and removing condensation



Press the button.

Ice and condensation are quickly removed from the windshield and the front side windows.

The air volume can be adjusted when the program is active.

If the windows are fogged over, additionally switch on the cooling function or press the AUTO button to utilize the condensation sensor.

## Maximum cooling



Press the button.

The system is set to the lowest temperature, maximum air volume and recirculated-air mode.

Air flows out of the vents for the upper body region. Open them for this purpose.

Air is cooled as quickly as possible:

- ▷ At an external temperature of approx. 32 °F/ 0 °C.
- ▷ When the engine is running.

The air volume can be adjusted when the program is active.

## Automatic recirculated-air control/ recirculated-air mode

You can respond to unpleasant odors or pollutants in the immediate environment by temporarily suspending the supply of outside air. The system then recirculates the air currently within the vehicle.



Press the button repeatedly to select an operating mode:

- ▷ LEDs off: outside air flows in continuously.

- ▶ Left LED on, automatic recirculated-air control: a sensor detects pollutants in the outside air and controls the shut-off automatically.
- ▶ Right LED on, recirculated-air mode: the supply of outside air into the vehicle is permanently blocked.

If the windows are fogged over, switch off the recirculated-air mode and press the AUTO button on the driver's side to utilize the condensation sensor. Make sure that air can flow onto the windshield.



**Continuous recirculated-air mode**

The recirculated-air mode should not be used for an extended period of time, as the air quality inside the vehicle deteriorates steadily. ◀

## Cooling function

The passenger compartment can only be cooled with the engine running.



Press the button.

The air is cooled and dehumidified and – depending on the temperature setting – warmed again.

Depending on the weather, the windshield may fog up briefly when the engine is started.

The cooling function is switched on automatically with the AUTO program.

When using the automatic climate control, condensation water, refer to page 148, develops that exits underneath the vehicle.

## Rear window defroster



Press the button.

The rear window defroster switches off automatically after a certain period of time.

## ALL program



Press the button.

The current settings on the driver's side for temperature, air volume, air distribution, and AUTO program are transferred to the front passenger side and to the left and right rear\*.

The program is switched off if the settings on the front passenger side or in the rear\* are changed.

## Residual heat

The heat stored in the engine is used to heat the interior.

## Functional requirement

- ▶ Up to 20 minutes after the engine has been switched off.
- ▶ Warm engine.
- ▶ The battery is sufficiently charged.
- ▶ External temperature below 77 °F/25 °C.

## Switching on

1. Switch off the ignition.



2. Press the right side of the button on the driver's side.

⏏ is shown on the display of the automatic climate control.

The interior temperature, air volume and air distribution can be adjusted with the ignition switched on.

## Switching off

At the lowest fan speed, press the left side of the button on the driver's side.

⏏ on the display of the automatic climate control goes out.

## Switching the system on/off

### Switching off

▶ Complete system:



At the lowest fan speed, press the left side of the button on the driver's side.

▶ On the front passenger side:



At the lowest fan speed, press the left side of the button on the front passenger side.

## Switching on

Press any button.

## Microfilter/activated-charcoal filter

The microfilter removes dust and pollen from the incoming air.

The activated-charcoal filter removes gaseous pollutants from the outside air that enters the vehicle.

This combined filter should be replaced during scheduled maintenance of your vehicle., refer to page 256

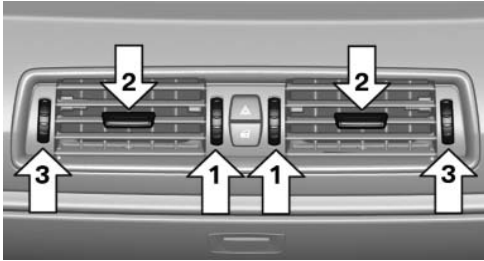

## Ventilation

### Front ventilation



- ▷ Thumbwheels\* for adjusting the temperature, arrows 1.  
Toward blue: colder.  
Toward red: warmer.
- ▷ Lever for changing the air flow direction, arrow 2.
- ▷ Thumbwheels for opening and closing the vents continuously, arrows 3.

### Ventilation levels\*

- ▷ Draft-free ventilation:  
Thumbwheel, arrow 3, in level  : the air current is fanned out.
- ▷ Maximum air volume:  
Thumbwheel, arrow 3, in level  : the air is partially fanned out and partially bundled.  
This maximizes the air supply.
- ▷ Direct ventilation:

Thumbwheel, arrow 3, in level  : the air is bundled and can be directed to a specific point.

## Adjusting the ventilation

- ▷ Ventilation for cooling:  
Adjust the vent to direct the air in your direction, e.g., if the vehicle interior is hot from the sun.
- ▷ Draft-free ventilation:  
Adjust the vent to let the air flow past you.

## Ventilation in rear, center

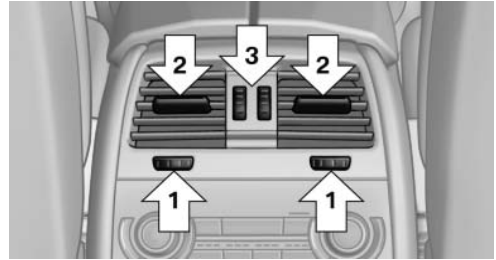

- ▷ Thumbwheels\* for adjusting the temperature, arrows 1.  
Toward blue: colder.  
Toward red: warmer.
- ▷ Lever for changing the air flow direction, arrow 2.
- ▷ Thumbwheels for opening and closing the vents continuously, arrow 3.

## Lateral ventilation\*

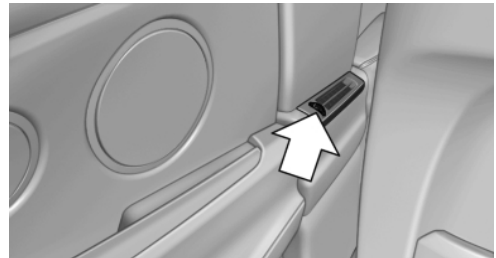

Thumbwheel for opening and closing the vents continuously, arrow.

# Rear automatic climate control\*

## At a glance



- 1 Temperature
- 2 AUTO program
- 3 Vent settings
- 4 Air volume, AUTO intensity
- 5 Display
- 6 Maximum cooling
- 7 Seat heating\* 54
- 8 Active seat ventilation\* 55

## Note

The air volume of the automatic climate control may be reduced automatically to save battery power.

## Switching the rear automatic climate control on/off

1. "Settings"
2. "Climate"
3. "Rear climate control"

The rear automatic climate control is not operational if the automatic climate control is switched off or if the function for defrosting or defogging the windows is active.

## AUTO program

 Press the button. Air volume, air distribution, and temperature are controlled automatically:

Depending on the selected temperature, AUTO intensity, and outside influences, the air is directed to the upper body and into the footwell.

The cooling function is switched on automatically with the AUTO program.

## Intensity of the AUTO program

With the AUTO program switched on, automatic control of the air volume and air distribution can be adjusted.



Press the left or right side of the button: decrease or increase the intensity.

The selected intensity is shown on the display of the automatic climate control.

## Temperature



Turn the wheel to set the desired temperature.

The automatic climate control achieves this temperature as quickly as possible, if necessary with the maximum cooling or heating capacity, and then keeps it constant.

Avoid rapidly switching between different temperature settings. The automatic climate control will not have sufficient time to adjust the set temperature.

## Manual air distribution

The air distribution can be adjusted to individual needs.



Press the button repeatedly to select a program:

- ▷ Upper body region.
- ▷ Upper body region and footwell.
- ▷ Footwell.

## Air volume, manual

To be able to manually adjust the air volume, switch off the AUTO program first.



Press the left or right side of the button: decrease or increase air volume.

The selected air volume is shown on the display of the automatic climate control.

## Switching the system on/off

### Switching off

 At the lowest fan speed, press the left side of the button on the driver's side.

### Switching on

Press any button.

### Maximum cooling

 Press the button.

The system is set to the lowest temperature, maximum air volume and recirculated-air mode.

Air flows out of the vents for the upper body region. Open them for this purpose.

Air is cooled as quickly as possible:

- ▷ At an external temperature of approx. 32 °F/ 0 °C.
- ▷ When the engine is running.

## Parked-car ventilation

### The concept

The parked-car ventilation ventilates the vehicle interior and lowers its temperature, if necessary.

The system can be switched on and off directly or by using two preset switch-on times. It remains switched on for 30 minutes.

They can be operated via iDrive.

### Parked-car ventilation

Using the preset switch-on time or when operated directly: any external temperature.

Open the vents to allow air to flow out.

### Switching on/off directly

1. "Settings"
2. "Climate"

3. "Activate parked-car vent."

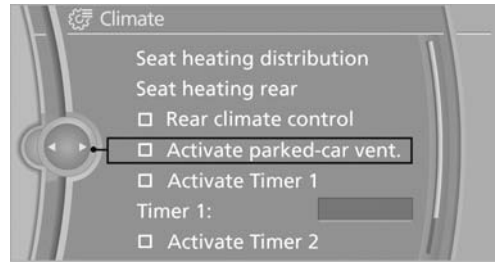

 The symbol on the automatic climate control flashes if the system is switched on.

The system continues to run for some time after being switched off.

### Preselecting the switch-on time

1. "Settings"
2. "Climate"
3. "Timer 1:" or "Timer 2:"
4. Set the desired time.

### Activating the switch-on time

1. "Settings"
2. "Climate"
3. "Activate Timer 1" or "Activate Timer 2"

 The symbol on the automatic climate control lights up when the switch-on time is activated.

 The symbol on the automatic climate control flashes when the system has been switched on.

The system will only be switched on within the next 24 hours. After that, it needs to be reactivated.



# Interior equipment

## Integrated universal remote control\*

### The concept

This system can replace up to three different hand-held transmitters for various types of remote-controlled equipment, such as garage doors or lighting systems.

The hand-held transmitter signal can be programmed on one of the three memory buttons.

The corresponding device can then be operated using the programmed memory button.

The LED indicates that a signal is being transmitted.

When selling the vehicle, delete the stored programs for security reasons.



During programming

During programming and before activating a device using the universal remote control, ensure that there are no people, animals, or objects in the range of movement of the remote-controlled device; otherwise, there is a risk of injury or damage.

Also follow the safety instructions of the hand-held transmitter. ◀

### Compatibility



If this symbol is printed on the packaging or in the instructions of the hand-held transmitter, the remote-controlled device is generally compatible with the universal remote control.

If you have any questions, please contact:

- ▷ Your service center.
- ▷ [www.homelink.com](http://www.homelink.com) on the Internet.

### Programming

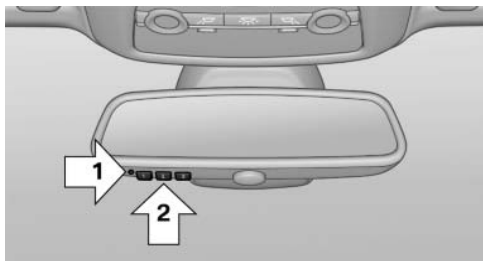

- ▷ LED, arrow 1.
- ▷ Memory buttons, arrow 2.

### Fixed-code hand-held transmitters

1. Switch on the ignition.
2. Initial setup:  
Press both outer buttons 1 and 3 for approx. 20 seconds until the LED flashes.  
All programs of the three memory buttons, arrow 2, are cleared.
3. Hold the hand-held transmitter a distance of approx. 2 to 8 in/5 to 20 cm from the memory buttons.
4. Simultaneously press the transmit button of the hand-held transmitter and the memory button of the universal remote control.  
The LED flashes slowly.
5. Release both buttons when the LED flashes rapidly.  
If the LED does not flash rapidly after approx. 15 seconds, change the distance and repeat the step.

The device can be operated using the memory button with the engine running or the ignition switched on.

### Malfunction

If the device cannot be used after repeated attempts at programming, please check whether the hand-held transmitter is equipped with an alternating code system.

To do so:

- ▷ Read the instructions of the hand-held transmitter.
- ▷ Press the memory button of the universal remote control for an extended period.

If the LED flashes rapidly for a brief period and then lights up continuously for approx. 2 seconds, the hand-held transmitter is equipped with an alternating code system.

In this case, program the memory buttons as described under Alternating-code hand-held transmitters.

### Alternating-code hand-held transmitters

Please obtain information on synchronizing the device in the operating manual of the device being set up.

Programming will be easier with the aid of a second person.

1. Park the vehicle within range of the remote-controlled device.
2. Program the universal remote control as described above under Fixed-code hand-held transmitters.
3. Press and hold the programmed button on the interior rearview mirror for approx. 5 seconds until the device to be adjusted is activated.

If the device does not become activated, press and hold the button and watch the LED:

- ▷ If the LED lights up continuously, the programming is completed. The device should become activated when the button is pressed briefly.
  - ▷ If the LED flashes for approx. 2 seconds and then lights up continuously, continue the programming procedure beginning with step 4.
4. Locate the button on the receiver of the device to be set, e.g., on the drive.

5. Press the button on the receiver of the device to be set. You have approx. 30 seconds for the next step.
6. Press the programmed memory button of the universal remote control three times.

The device can be operated when the engine is running or the ignition is switched on.

### Reassigning individual programs

1. Switch on the ignition.
2. Hold the hand-held transmitter a distance of approx. 2 to 8 in/5 to 20 cm from the memory buttons.
3. Press the memory button of the universal remote control.
4. If the LED flashes slowly after approx. 20 seconds, press the transmit button on the hand-held transmitter.
5. Release both buttons when the LED flashes rapidly.

If the LED does not flash rapidly after approx. 15 seconds, change the distance and repeat the step.

### Deleting all stored programs

Press the left and right memory buttons for approx. 20 seconds until the LED flashes rapidly.

All stored programs are deleted.

The programs cannot be deleted individually.

## Ashtray/cigarette lighter\*

### Front

#### Opening

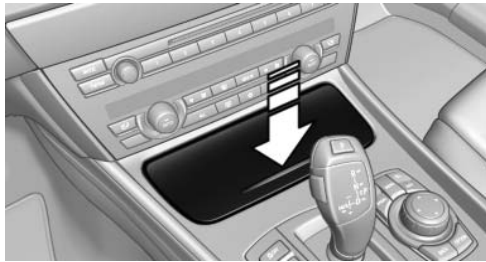

Press on the cover.

#### Emptying

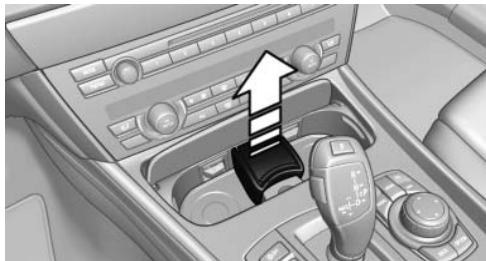

Take out the insert.

#### Lighter



Push in the lighter.

The lighter can be removed as soon as it pops back out.



**Danger of burns**

Only hold the hot lighter by its knob; otherwise, there is the danger of getting burned.

Switch off the ignition and take the remote control with you when leaving the vehicle so that children cannot use the lighter and burn themselves. ◀

### Rear

#### Opening

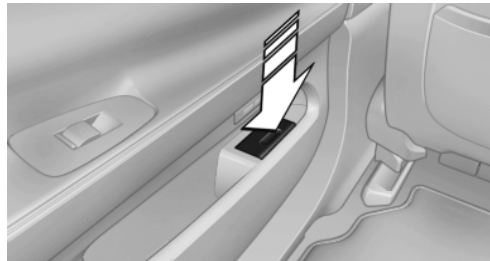

Press on the cover.

#### Emptying

Take out the insert.

## Connecting electrical devices

### Sockets

The lighter socket can be used as a socket for electrical equipment while the engine is running or when the ignition is switched on. The total load of all sockets must not exceed 140 Watt at 12 V.

Do not damage the socket by using unsuitable connectors.

### Front center console



Press on the cover.

Remove the cover or cigarette lighter\*.

## Rear center console



Remove the cover.

## In the cargo area

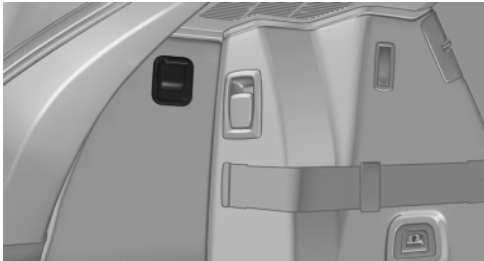

To access the socket: fold open the cover.

## Cargo area

### Trunk cover

#### Note

 Do not deposit heavy objects  
Do not deposit heavy or hard objects on the trunk cover. Otherwise, they could endanger occupants during braking and evasive maneuvers, for example. ◀

### Removing

To load bulky luggage, the cover can be removed.

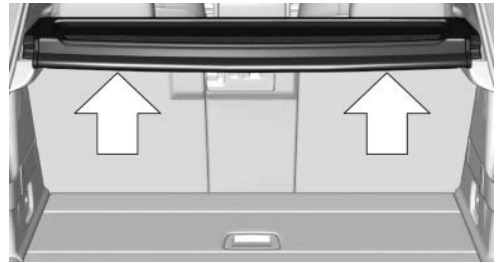

1. Place your hands into the two recessed grips on the bottom of the cover.
2. Push up the cover.

The cover can be stowed in the rear cargo area floor compartment, refer to page 142.

### Installing

1. Insert the trunk cover into the two front retaining pins.

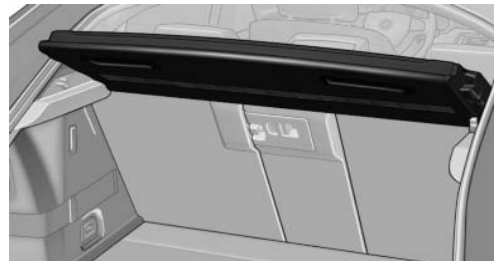

2. Fold down the cover until it engages.

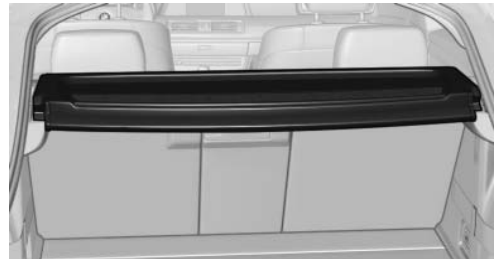

## Through-loading system

### General information

The cargo area can be expanded by folding down the cargo partition and the rear seat backrest.

The cargo partition and the rear backrest are subdivided at a ratio of 40–20–40. You can also fold down the left and right sides separately.

## Foldable rear backrests, manual

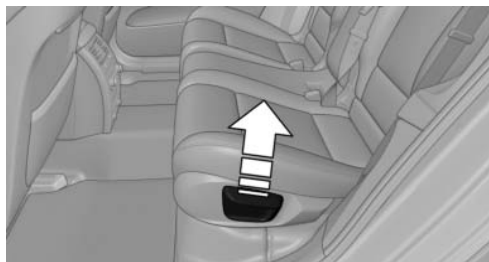

Pull the lever. The backrest folds forward.

Fold the backrest back; the backrest engages in an upright position. Pull the lever again to adjust the backrest to the desired angle.



### Locking the backrests

Before letting passengers ride in the rear, engage the seat backrests, locking them in place. Otherwise, there is the danger of an accident due to unexpected seat movement. ◀

## Foldable rear backrests, powered\*

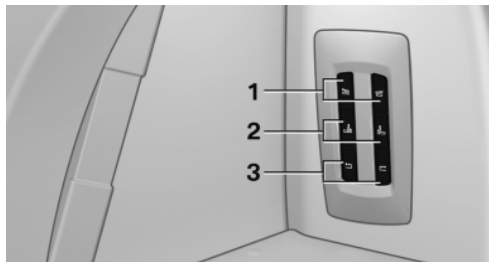

- 1 Fold backrest forward
- 2 Loading position
- 3 Basic position

### Fold backrest forward



Move the front seats to an upright position

Before folding down the rear backrests, ensure that the front seats are moved forward slightly and are in an upright position. Other-

wise, the head restraint and screen could be damaged. ◀



Press the button until the backrest is folded all the way forward.

### Folding the backrest back

Before anyone can be transported in the rear:

1. Put the rear seat backrests into their standard position.
2. For the best possible individual seat position, adjust the inclination of the rear seat backrest if necessary.



Adjust the standard position of the rear seat backrest

Before transporting passengers in the rear and adjusting the rear seat backrest, set the rear seat backrest to its basic position. Otherwise, the rear seats may not effectively restrain passengers in an accident if the backrests are not adequately inclined. ◀

### Loading position



Press the button. The seat moves forward and the backrest moves to the basic position. Comfortable seating is still possible although knee clearance is reduced.

### Basic position



Press and hold the button until the seat stops automatically in its basic position.

### Operation of the rear backrest was deactivated

After a brief period, operation of the rear backrest is deactivated to save battery power.

To reactivate operation:

- Open or close a door or the tailgate.
- Press a button on the remote control.
- Press the Start/Stop button.

## Folding down the cargo partition



### Danger of pinching

Before folding down the trunk partition, ensure that the area of movement of the partition is clear. In particular, ensure that no one is located in the area of movement and that no one reaches into the area of movement of the trunk partition when the middle section is folded down. Otherwise, injury or damage may result. ◀

1. Fold the rear seat backrest forward.
2. To release the cargo partition, pull the corresponding lever in the cargo area. The cargo partition folds forward.

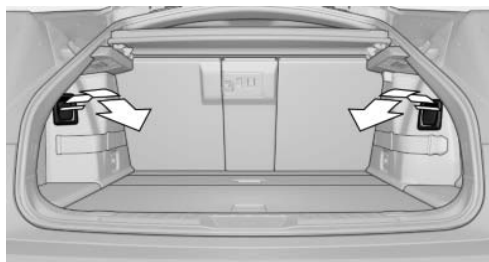

## Unlatching center cargo partition



Press the opener toward the left.

## Closing the cargo partition

Fold back and engage the cargo partition.



### Danger of pinching

Before closing the trunk partition, make sure that the closing path is clear; otherwise, injuries may result. ◀



Ensure that the lock is securely engaged

When folding back the backrest, be sure that it locks in place securely. If it is not properly engaged, transported cargo could enter the passenger compartment during braking or evasive maneuvers and endanger the vehicle occupants. ◀

## Loading position

To expand the trunk, the cargo cover can be moved into a vertical position.

1. Move the rear backrest to the loading position, refer to page 137.
2. To release the cargo cover, pull both levers in the trunk. The cargo cover folds into an upright position and rests against the rear backrest.

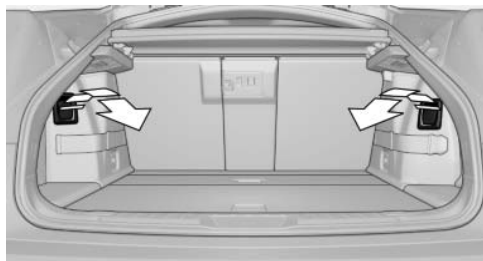

## Repositioning

Fold back the cargo cover and snap into place

## Ski and snowboard bag\*

### General information

The ski and snowboard bag is contained in a protective jacket in the trunk.

Follow the installation and operation instructions included in the protective jacket.

# Storage compartments

## Storage compartments

The following storage compartments are available in the vehicle interior:

- ▷ Glove compartment on the driver's and front passenger side, refer to page 139.
- ▷ Storage compartment in the center console, refer to page 141.
- ▷ Storage compartment in the center armrest, refer to page 140, in the front and rear.
- ▷ Compartments in the doors.
- ▷ Pockets on the backrests of the front seats\*.
- ▷ Net in the front passenger footwell.

 No loose objects in the passenger compartment

Do not stow any objects in the passenger compartment without securing them; otherwise, they may present a danger to occupants for instance during braking and avoidance maneuvers. ◀

## Glove compartment

### Front passenger side

#### Opening



Pull the handle.

The light in the glove compartment switches on.

 Close the glove compartment again immediately

Close the glove compartment immediately after use while driving; otherwise, injury may occur during accidents. ◀

#### Closing

Fold up the cover.

#### USB interface for data transfer

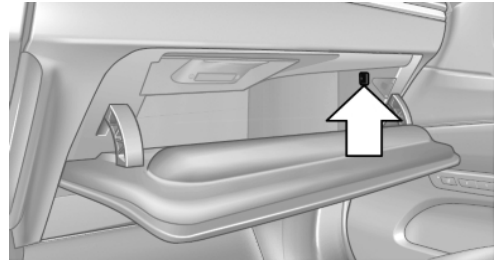

Connection for importing and exporting data on USB devices, e.g.:

- ▷ Personal Profile settings, refer to page 33.
- ▷ Music collection, refer to page 188.

Observe the following when connecting:

- ▷ Do not use force when plugging the connector into the USB interface.
- ▷ Do not connect devices such as fans or lamps to the USB interface.
- ▷ Do not connect USB hard drives.
- ▷ Do not use the USB interface to recharge external devices.



## Driver's side

### Opening



Pull the handle.

**⚠** Close the glove compartment again immediately

Close the glove compartment immediately after use while driving; otherwise, injury may occur during accidents. ◀

### Closing

Fold up the cover.

## Center armrest

### Front

A storage compartment is located in the center armrest between the front seats.

### Opening

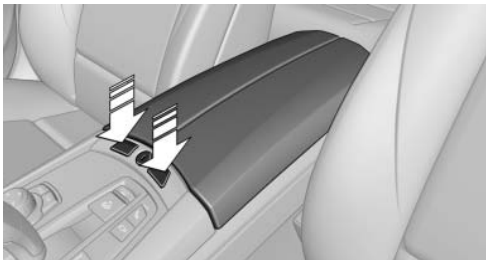

Press the buttons next to the lock.

## Locking the storage compartment



The storage compartment in the armrest can be locked with an integrated key to separately secure the tailgate, refer to page 42, for example.

After the storage compartment is locked, the remote control can be handed out without the integrated key, refer to page 32, for instance at a hotel.

This prevents access to the storage compartment and to the cargo area.

## Connection for an external audio device

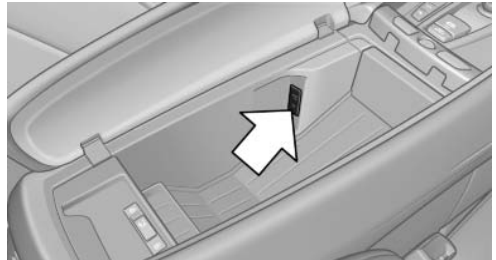

This can be used to connect an external audio device, such as a CD or MP3 player.

- ▷ AUX-IN port, refer to page 192.
- ▷ USB audio interface\*, refer to page 193.

### Rear

A storage compartment is located in the center armrest between the seats.



## Folding down

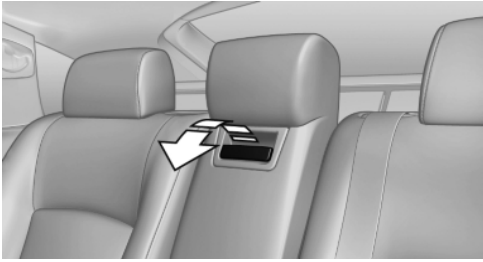

Pull on the opener and fold the armrest forward.

## Opening

Storage compartment in the rear center armrest.

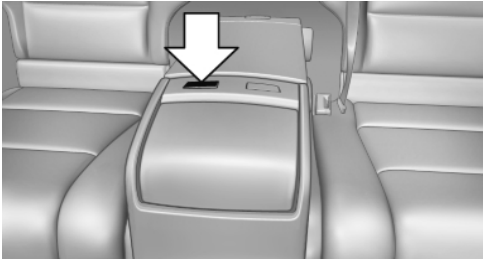

Push the button and fold open the cover.

## Storage compartment in the center console

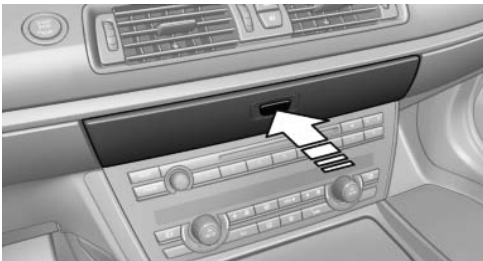

To open: press the button.

## Cupholders

### Notes

 Shatter-proof containers and no hot drinks

Use light and shatter-proof containers and do not transport hot drinks. Otherwise, there is the increased danger of injury in an accident. ◀

 Unsuitable containers  
Do not forcefully push unsuitable containers into the cupholders. This may result in damage. ◀

### Front



To open: press on the cover.

### Rear

In the front center armrest.

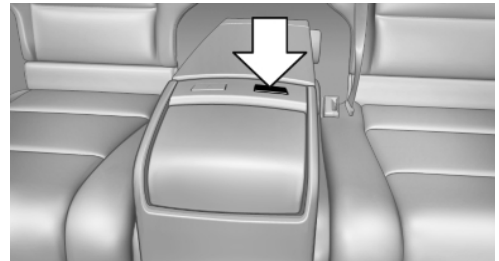

To open: press the button.

## Clothes hooks

The clothes hooks are located next to the grab handles in the rear and on the door pillar in the rear.

**⚠** Do not obstruct view  
When suspending clothing from the hooks, ensure that it will not obstruct the driver's vision. ◀

**⚠** No heavy objects  
Do not hang heavy objects from the hooks; otherwise, they may present a danger to passengers during braking and evasive maneuvers. ◀

## Storage compartments in the cargo area

### Retaining straps

Retaining straps on the left\* and right side trim for fastening small objects.

### Multi-function hook

There are two multi-function hooks on the cargo area walls.

1. Open the holder by pressing on the button.

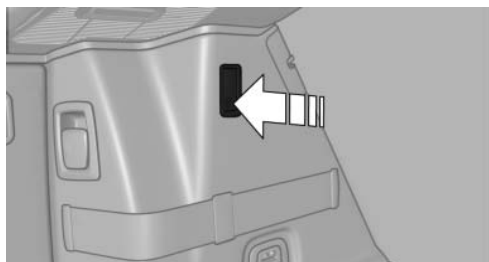

2. Press the bag handle into the holder from above.

**⚠** Light and suitable objects only  
Only hang light bags or suitable objects from the holders. Otherwise, there is a danger of objects flying about during braking and evasive maneuvers.

Only transport heavy luggage in the trunk if it has been appropriately secured. ◀

## Storage compartments in the floor

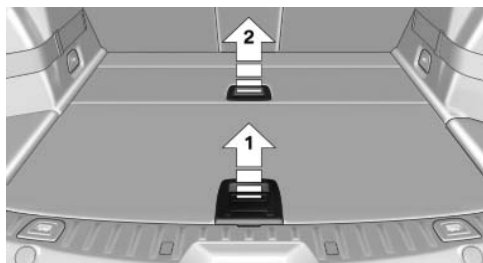

### Rear compartment

The trunk cover, refer to page 136, can be stowed in the rear compartment.

To open the cover, pull upward on the handle, arrow 1.

To close the cover, press downward until it locks.

You can fix the cover in an upright position, if needed. To do so, unhook the right-hand retaining strap and hook it into the rear of the cover.

**⚠** Do not stow heavy objects  
Only stow light objects in the rear compartment; otherwise, damage may occur. ◀

### Front compartment

To open, reach into the recess and raise the handle, arrow 2.

The cover can be completely removed.

### Lashing eyes

To secure the cargo, refer to page 149, there are lashing eyes in the cargo area.





## Driving tips

This chapter provides you with information useful in dealing with specific driving and operating modes.

# Things to remember when driving

## Breaking-in period

### General information

Moving parts need to be broken in to adjust to each other.

The following instructions will help achieve a long vehicle life and good economy.

### Engine and differential

Always obey the official speed limit.

### Up to 1,200 miles/2,000 km

Do not exceed the maximum engine and road speed:

- ▷ For gasoline engine, 4500 rpm and 100 mph/160 km/h.

Avoid full-throttle operation and use of the transmission's kickdown mode for the initial miles.

### From 1,200 miles/2,000 km

The engine and vehicle speed can gradually be increased.

### Tires

Due to technical factors associated with their manufacture, tires do not achieve their full traction potential until after an initial breaking-in period.

Drive conservatively for the first 200 miles/300 km.

### Brake system

Brakes require an initial break-in period of approx. 300 miles/500 km to achieve optimized contact and wear patterns between brake pads and discs. Drive moderately during this break-in period.

### Following part replacement

The same breaking in procedures should be observed if any of the components mentioned

above have to be renewed in the course of the vehicle's operating life.

## General driving notes

### Closing the tailgate



Drive with the tailgate closed

Only drive with the tailgate closed; otherwise, in the event of an accident or braking or evasive maneuvers, passengers or other road users may be injured or the vehicle may be damaged. In addition, exhaust fumes may enter the passenger compartment. ◀

If driving with the tailgate open cannot be avoided:

- ▷ Close all windows and the glass sunroof\*.
- ▷ Greatly increase the blower speed.
- ▷ Drive moderately.

### Hot exhaust system



Hot exhaust system

High temperatures are generated in the exhaust system.

Do not remove the heat shields installed and never apply undercoating to them. When driving, standing at idle and while parking, take care to avoid possible contact between the hot exhaust system and any highly flammable materials such as hay, leaves, grass, etc. Such contact could lead to a fire, and with it the risk of serious personal injury as well as property damage.

Do not touch hot exhaust pipes; otherwise, there is the danger of getting burned. ◀

## Climate control windshield\*

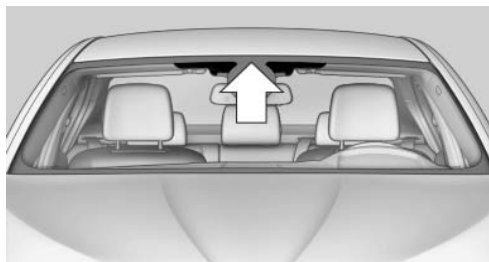

The marked area is not covered with heat reflective coating.

Use this area for garage door openers, devices for electronic toll collection, etc.

## Climate control laminated tinted safety glass\*

The vehicle glass provides full protection against the harmful effects of UV radiation on the skin.

## Mobile communication devices in the vehicle

 Mobile communication devices in the vehicle

It is advised that you do not use mobile communication devices, e.g., mobile phones, inside the vehicle without connecting them directly to the external antenna. Otherwise, the vehicle electronics and mobile communication devices can interfere with each other. In addition, there is no assurance that the radiation generated during transmission will be discharged from the vehicle interior. ◀

## Hydroplaning

On wet or slushy roads, a wedge of water can form between the tires and road surface.

This phenomenon is referred to as hydroplaning. It is characterized by a partial or complete loss of contact between the tires and the road surface, ultimately undermining your ability to steer and brake the vehicle.

 Hydroplaning

When driving on wet or slushy roads, reduce your speed to prevent hydroplaning. ◀

## Driving through water

Drive through calm water only if it is not deeper than 9.8 inches/25 cm and at this height, no faster than walking speed, up to 6 mph/10 km/h.

 Adhere to water depth and speed limitations

Do not exceed this water depth and walking speed; otherwise, the vehicle's engine, the electrical systems and the transmission may be damaged. ◀

## Braking safely

Your vehicle is equipped with ABS as a standard feature.

Applying the brakes fully is the most effective way of braking in situations when this is necessary.

The vehicle maintains steering responsiveness. You can still avoid any obstacles with a minimum of steering effort.

Pulsation of the brake pedal and sounds from the hydraulic circuits indicate that ABS is in its active mode.

## Objects in the area around the pedals

 No objects in the area around the pedals  
Keep floor mats, carpets, and any other objects out of the area of motion of the pedals; otherwise, the function of the pedals could be impeded while driving

Do not place additional floor mats over existing mats or other objects.

Only use floor mats that have been approved for the vehicle and can be properly fixed in place.

Ensure that the floor mats are securely fastened again after they were removed for cleaning, for example. ◀

### Driving in wet conditions

When roads are wet or there is heavy rain, briefly exert gentle pressure on the brake pedal every few miles.

Ensure that this action does not endanger other road users.

The heat generated in this process helps dry the brake discs and pads.

In this way braking efficiency will be available when you need it.

### Hills

Drive long or steep downhill gradients in the gear in which the least braking is required. Otherwise, the brake system may overheat, resulting in a reduction in the brake system efficiency.

You can increase the engine's braking effect by shifting down in the manual mode of the automatic transmission, refer to page 73.

 Avoid load on the brakes

Avoid placing excessive load on the brake system. Light but consistent brake pressure can lead to high temperatures, brake wear and possibly even brake failure. ◀

 Do not drive in neutral

Do not drive in neutral or with the engine stopped, as doing so disables engine braking. In addition, steering and brake assist is unavailable with the engine stopped. ◀

### Brake disc corrosion

Corrosion on the brake discs and contamination on the brake pads are furthered by:

- ▷ Low mileage.
- ▷ Extended periods when the vehicle is not used at all.
- ▷ Infrequent use of the brakes.

Corrosion occurs when the minimum pressure that must be exerted by the pads during brake applications to clean the discs is not reached.

Should corrosion form on the brake discs, the brakes will tend to respond with a pulsating effect that generally cannot be corrected.

### Condensation under the parked vehicle

When using the automatic climate control, condensation water develops that exits underneath the vehicle.

Therefore, traces of condensed water under the vehicle are normal.

### Loading

 Overloading the vehicle

To avoid exceeding the approved carrying capacity of the tires, never overload the vehicle. Overloading can lead to overheating and increases the rate at which damage develops inside the tires. This could result in a sudden loss of tire inflation pressure. ◀

 No fluids in the trunk

Make sure that fluids do not leak into the trunk; otherwise, the vehicle may be damaged. ◀

### Determining the load limit



1. Locate the following statement on your vehicle's placard\*:
  - ▷ The combined weight of occupants and cargo should never exceed XXX kg or YYY lbs. Otherwise, damage to the vehicle and unstable driving situations may result.
2. Determine the combined weight of the driver and passengers that will be riding in your vehicle.
3. Subtract the combined weight of the driver and passengers from XXX kilograms or YYY pounds.



- The resulting figure equals the available amount of cargo and luggage load capacity. For example, if the YYY amount equals 1,000 lbs and there will be four 150 lbs passengers in your vehicle, the amount of available cargo and luggage load capacity is 400 lbs: 1,000 lbs minus 600 lbs = 400 lbs.
- Determine the combined weight of luggage and cargo being loaded on the vehicle. That weight may not safely exceed the available cargo and luggage load capacity calculated in Step 4.

## Load

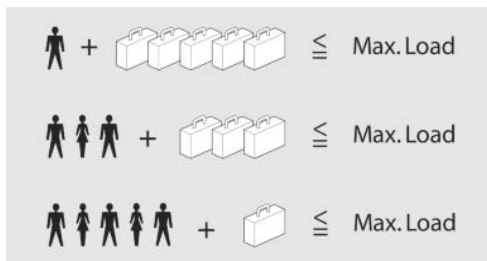

The maximum load is the sum of the weight of the occupants and the cargo.

The greater the weight of the occupants, the less cargo that can be transported.

## Stowing cargo

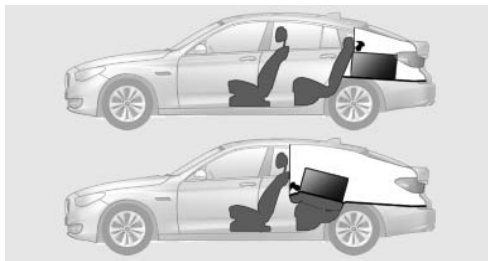

- ▶ Heavy cargo: stow as far forward and as low as possible, ideally directly behind the cargo partition.
- ▶ Very heavy cargo: when the rear seat is not occupied, secure each of the outer safety belts in the opposite buckle.
- ▶ Cover sharp edges and corners.

- ▶ If necessary, fold down the rear backrests, including the cargo partition, to stow cargo.

## Securing cargo

### Lashing eyes in the cargo area

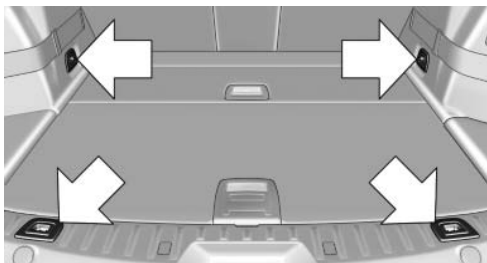

To secure the cargo, there are four lashing eyes in the cargo area

### Securing cargo

- ▶ Smaller and lighter items: secure with retaining straps or with a cargo net\* or draw straps.
- ▶ Larger and heavy objects: secure with cargo straps\*.

Cargo straps, cargo netting, retaining straps or draw straps on the lashing eyes in the cargo area.



### Securing cargo

Always position and secure the cargo as described above; otherwise, it can endanger the car's occupants if sudden braking or swerving becomes necessary.

Heavy or hard objects should not be carried loose inside the car; otherwise, they could be thrown around as a result of hard braking, sudden swerves, etc., and endanger the occupants. ◀

## Roof-mounted luggage rack

### Note

Roof racks are available as special accessories.

## Attachment

Follow the installation instructions of the roof rack.

### Roof drip rail with flaps\*



The anchorage points are located in the roof drip rail above the doors.

Fold the cover outward.

## Mounting

Be sure that adequate clearance is maintained for raising and opening the glass sunroof\*.

### Magnetic roof-mounted luggage rack

Because of the aluminum roof, magnetic roof-mounted luggage racks cannot be mounted.

## Loading

Because roof racks raise the vehicle's center of gravity when loaded, they have a major effect on vehicle handling and steering response.

Therefore, note the following when loading and driving:

- ▷ Do not exceed the approved roof/axle loads and the approved gross vehicle weight.
- ▷ Distribute the roof load uniformly.
- ▷ The roof load should not be too large in area.
- ▷ Always load the heaviest pieces on the bottom.
- ▷ Secure the roof luggage firmly, e.g., tie with ratchet straps.
- ▷ Do not let objects project into the opening path of the tailgate.

- ▷ Drive smoothly. Avoid sudden acceleration and braking maneuvers. Take corners gently.

## Saving fuel

### General information

Your vehicle contains advanced technology for the reduction of fuel consumption and emissions.

Fuel consumption depends on a number of different factors.

The implementation of certain measures, driving style and regular maintenance can have an influence on fuel consumption and on the environmental impact.

### Remove unnecessary cargo

Additional weight increases fuel consumption.

### Remove attached parts following use

Remove auxiliary mirrors, roof or rear luggage racks which are no longer required following use.

Attached parts on the vehicle impair the aerodynamics and increase the fuel consumption.

### Close the windows and glass sunroof\*

Driving with the glass sunroof and windows open results in increased air resistance and raises fuel consumption.

### Check the tire inflation pressure regularly

Check and, if necessary, correct the tire inflation pressure at least twice a month and before starting on a long trip.

Low tire inflation pressure increases rolling resistance and thus raises fuel consumption and tire wear.

### Drive away without delay

Do not wait for the engine to warm up while the vehicle remains stationary. Start driving right away, but at moderate engine speeds.

This is the fastest way for the cold engine to reach its operating temperature.

### **Look well ahead when driving**

Avoid unnecessary acceleration and braking.

By maintaining a suitable distance to the vehicle driving ahead of you.

Driving smoothly and looking ahead reduces fuel consumption.

### **Use coasting conditions**

When approaching a red light, take your foot off the accelerator and let the vehicle coast to a halt.

On a downhill gradient, take your foot off the accelerator and let the vehicle roll.

The flow of fuel is interrupted while coasting.

### **Switch off the engine during longer stops**

Switch off the engine during longer stops, e.g., at traffic lights, railroad crossings or in traffic congestion.

Fuel savings are achieved after the vehicle is switched off for only approx. 4 seconds.

The Automatic Engine Start/Stop Function\* of your vehicle automatically switches off the engine during a stop.

### **Switch off any functions that are not currently needed**

Functions such as seat heating and the rear window defroster require a lot of energy and consume additional fuel, especially in city and stop-and-go traffic.

Therefore, switch off these functions if they are not actually needed.

### **Have maintenance carried out**

Have vehicles maintained regularly to achieve optimal vehicle economy and operating life.

Have the maintenance carried out by your service center.

Please also note the BMW Maintenance System.



# Navigation

This chapter contains various examples of how the navigation system can guide you reliably to your destination.

# Navigation\*

## Navigation system

### General information

The navigation system can determine the precise position of the vehicle, with the aid of satellites and vehicle sensors, and can reliably guide you to every entered destination.

Navigation data are stored in the vehicle and can be updated.



Entries in stationary vehicle

Enter data only when the vehicle is stationary, and always give priority to the applicable traffic regulations in the event of any contradiction between traffic and road conditions and the instructions issued by the navigation system. Failure to take to this precaution can place you in violation of the law and put vehicle occupants and other road users in danger. ◀

## Destination input

### Manual destination entry

#### General information

The system supports you in entering street names and house numbers by automatically completing the entry and providing entry comparisons, refer to page 24.

Stored town/city and street names can be called up quickly.

- ▷ If the existing entries should not be changed, the entries for the state/province and town/city can be skipped.
- ▷ Destination guidance is started to the town/city center if no street is entered.

#### Entering a state/province

1. Press the MENU button.
2. "Navigation"

3. "Enter address"

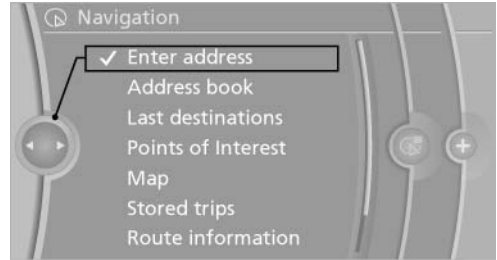

4. Select "State/Province" or the displayed state/province.

### Entering a town/city

1. Select "Town/City/Postal Code" or the displayed town/city.

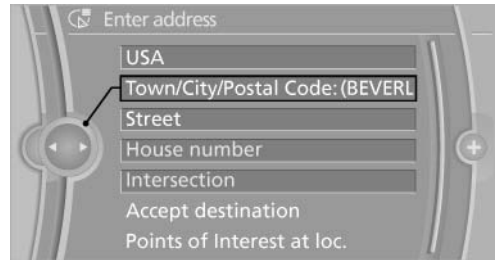

2. Select letters, if necessary.  
The list is narrowed down further with each entry.

3. Move the controller to the right.
4. Select the town/city name from the list.

If there are several towns/cities with the same name:

1. Change to the list of town/city names.
2. Highlight the town/city.
3. Select the town/city.

#### Entering the postal code\*

1. Select "Town/City/Postal Code" or the displayed town/city.
2. 1@+ Select the symbol.



3. Select the numbers.
4. Change to the list of postal codes and towns/cities.
5. Highlight the entry.
6. Selecting an entry.

### Entering a street and intersection

1. Select "Street" or the displayed street.
2. Enter a street and intersection in the same way as you would enter a town/city.

If there are several streets with the same name:

1. Change to the list of street names.
2. Highlight the street.
3. Select the street.

### Alternative: enter the street address and house number

1. Select "Street" or the displayed street.
2. Enter the street as you would the town/city.
3. "House number"
4. Select the numbers.
5. Change to the list of house numbers.
6. Select a house number or range of house numbers.

### Street does not exist in the destination city/town

The desired street does not exist in the specified city/town because it belongs to another part of the city/town.

1. "Navigation"
2. "Enter address"
3. Select "Street" or the displayed street.
4. Change to the list of street names.
5. Select "In" the displayed country.

All streets of the selected state/province are offered. The associated town/city is displayed after the street name.

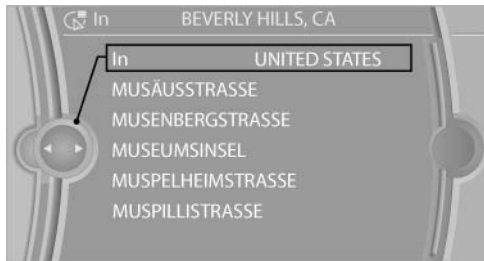

6. Select the letters.
7. Change to the list of street names.
8. Highlight the street.
9. Select the street.

### Starting destination guidance after entering the destination

1. "Accept destination"
2. "Start guidance" or "Add as another destination"  
Add a destination as a further destination, refer to page 160.

### Address book

#### Selecting a destination from the address book

1. "Navigation"
2. "Address book"  
Contacts with addresses are displayed if these have been checked as destinations. If the mobile phone\* does not display the contacts with addresses, they must first be

checked as a destination, refer to page 231.

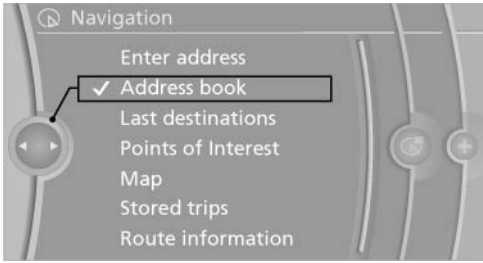

3. Select a contact in the list or, if desired, with "A-Z search".
4. "Business address" or "Home address"

### Storing the destination in the address book

After entering the destination, store the destination in the address book.

1. Open "Options".
2. "Store as new contact" or "Add to existing contact"

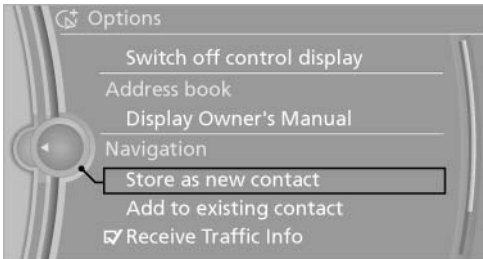

3. Select an existing contact, if available.
4. "Business address" or "Home address"
5. Enter "Last name" and, if necessary, "First name".
6. "Store in vehicle"

### Storing the position

The current position can be stored in the address book.

1. "Navigation"
2. Open "Options".

3. "Store position as contact" or "Add position to contact"

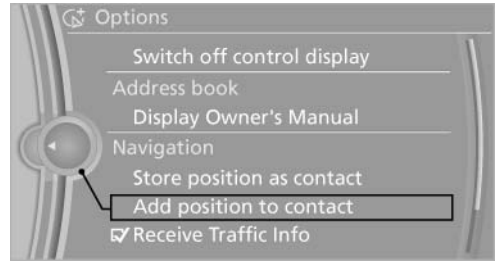

4. Depending on the selection, choose an existing contact from the list. Select the type of address and enter the first and last name.
5. "Store in vehicle"

### Editing or deleting an address

1. "Navigation"
2. "Address book"
3. Highlight the entry.
4. Open "Options".
5. "Edit in Contacts" or "Delete entry"

### Using the home address as the destination

The home address must be stored. Specify the home address, refer to page 230.

1. "Navigation"
2. "Address book"
3. "Home"

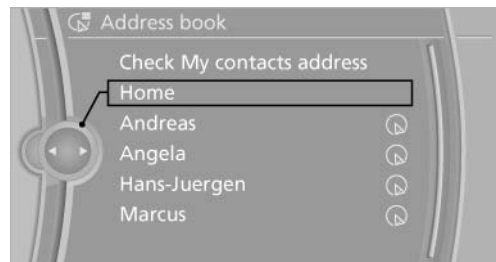

4. "Start guidance"



## Last destinations

### At a glance

The destinations previously entered are stored automatically.

The destinations can be called up and used as a destination for destination guidance.

### Calling up the last destination

1. "Navigation"
2. "Last destinations"

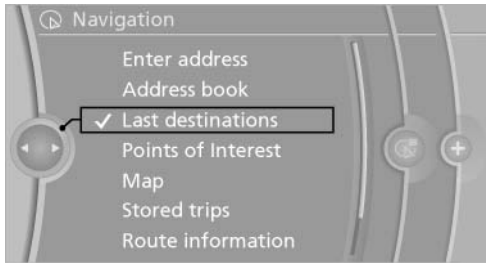

### Starting destination guidance

1. "Navigation"
2. "Last destinations"
3. Select the destination.
4. "Start guidance"

### Editing the destination

1. "Navigation"
2. "Last destinations"
3. Highlight the destination.
4. Open "Options".
5. "Edit destination"

### Deleting the last destinations

1. "Navigation"
2. "Last destinations"
3. Highlight the destination.
4. Open "Options".
5. "Delete entry" or "Delete all last destinations"

## Special destinations

### Opening the search for special destinations

To select special destinations, e.g., hotels or tourist attractions:

1. "Navigation"
2. "Points of Interest"
3. Select the search function.

### Online Search\*

1. "Google™ Search"
2. Select a special destination.
3. Select the symbol.
4. "Start guidance"

### A-Z search

1. "A-Z search"
2. "Town/City"  
Select or enter the town/city.
3. "Category"
4. Select the category.
5. "Category details"

For some special destinations, multiple category details can be selected. Move the controller to the left to leave the category details.

6. "Keyword"
7. Enter the keyword.  
A list of the special destinations is displayed.
8. Select a special destination.  
Details are displayed.

If multiple details are stored, you can leaf through the pages.

If a phone number is available, a connection can be established if necessary.

9. Select the symbol.  
"Start guidance" or "Add as another destination"  
Add a destination as a further destination, refer to page 160.

"Start search": if a search term is not entered, the search is repeated with the previous search term.

## Category search

1. "Category search"
2. "Town/City"  
Select or enter the town/city.
3. "Category"
4. Select the category.
5. "Category details"  
For some special destinations, multiple category details can be selected. Move the controller to the left to leave the category details.
6. "Start search"  
A list of the special destinations is displayed.
7. Select a special destination.  
Details are displayed.  
If multiple details are stored, you can leaf through the pages.  
If a phone number is available, a connection can be established if necessary.
8.  Select the symbol.  
"Start guidance" or "Add as another destination"  
Add a destination as a further destination, refer to page 160.

## Display of special destinations

List of special destinations: special destinations are organized by distance and are displayed with a directional arrow to the special destination. on the split screen, special destinations of the selected category are displayed in the map view as symbols. The display depends on the scale of the map and the category.

## Destination entry via BMW Assist\*

A connection is established to the Concierge service, refer to page 233.

1. "Navigation"
2. "Enter address"
3. Open "Options".
4. "BMW Assist dest. entry"

## Displaying special destinations in the map

To display symbols of the special destinations in the map view:

1. "Navigation"
2. "Map"
3. Open "Options".
4. "Display Points of Interest"
5. Select the setting.

## Destination entry by map

### Selecting the destination

1. "Navigation"
2. "Map"  
The current position of the vehicle is indicated on the map.
3.  "Interactive map"

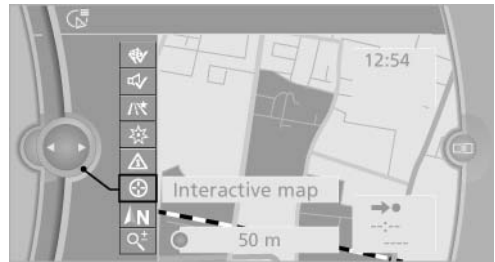

4. Select the destination with crosshairs.
  - ▷ To change the scale: turn the controller.
  - ▷ To shift the map: move the controller in the required direction.
  - ▷ To shift the map diagonally: move the controller in the required direction and turn it.

## Specifying the street

If the system does not recognize a street, one of the following is displayed:

- ▷ The name of a street in the vicinity.
- ▷ The county.
- ▷ The coordinates of the destination.

## Additional functions

Additional functions are available on the interactive map after the controller is pressed.



- ▷  Select the symbol.  
"Start guidance" or "Add as another destination"  
Add a destination as a further destination, refer to page 160.
- ▷ "Exit interactive map": return to the map view.
- ▷ "View in northern direction" or "View in driving direction"
- ▷ "Display destination": the map section around the destination is displayed.
- ▷ "Display current location": the map section around your current location is displayed.
- ▷ "Find points of interest": the search for special destinations is started.

## Destination entry by voice\*

### General information

- ▷ Instructions for voice activation system, refer to page 25.
- ▷ When making a destination entry by voice, you can change between voice operation and iDrive.

- ▷ To have the available spoken instructions read out loud: ›Voice commands‹

## Saying the entries

- ▷ the town/city, street, and house number can be entered as a single command\*.
- ▷ Countries, towns and cities, streets, and intersections can be said as whole words\* or spelled in the language of the system, refer to page 82.

Example: to enter a town/city in a US state as a whole word, the language of the system must be English.

- ▷ Spell the entry if the spoken language and the language of the system differ.
- ▷ Say the letters smoothly, and avoid exaggerating the pronunciation and inserting lengthy pauses between the letters.
- ▷ The options available for entering data depend on the navigation data and the country and language settings.

## entering an address using a command\*

1.  Press the button on the steering wheel.
2. ›Enter address‹
3. Wait for a request from the system.
4. Say the address in the suggested order.
5. Continue making the entry as prompted by the system.

If necessary, individually name the separate components of the address, e.g., the town/city.

## Entering a town/city separately

The name of the town/city can be said as a word\* or spelled out.

With the destination entry menu displayed:

1.  Press the button on the steering wheel.
2. ›City‹ or ›Spell city‹.
3. Wait for the system to prompt you for the town/city.

- Say the name of the town/city, or say at least the first three letters.  
Depending on the entry, up to 20 towns/cities may be suggested.
- Select the town/city.
  - To select a recommended town/city: ›Yes‹
  - To select a different town/city: ›New entry‹
  - Select an entry: ›Entry ...‹ e.g., entry 2
  - To spell an entry: ›Spell city‹
- Continue making the entry as prompted by the system.

If there are several towns/cities with the same name:

Towns/cities of the same name are grouped in a list and displayed as one location followed by an ellipsis.

- Select an entry: ›Yes‹ or ›Entry ...‹ e.g., Entry 2.
- Select the desired town/city.

## Entering a street or intersection separately

Enter a street and intersection in the same way as you would enter a town/city.

## Entering a house number separately

Depending on the data in the navigation system, house numbers up to number 2000 can be entered.

- ›House number‹
- Say the house number.  
Say each digit separately.
- Continue making the entry as prompted by the system.

## Planning a trip with intermediate destinations

### New trip

A trip can be planned with several intermediate destinations.

- "Navigation"
- "Map"
- Move the controller to the left if necessary.
- 📍 "Guidance"
- "Enter new destination"
- Select the type of destination entry.

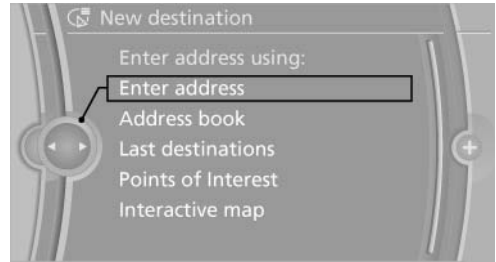

- Enter the intermediate destination.
- "Start guidance"

## Entering intermediate destinations

For a trip, a max. of 30 intermediate destinations can be entered.

- "Enter new destination"
  - Select the type of destination entry.
  - Enter the intermediate destination.
  - "Add as another destination"
- The intermediate destination is entered in the destination list and is highlighted.
- Turn the controller until the intermediate destination is located in the desired position in the list.
  - Press the controller.

## Starting the trip

- After all intermediate destinations are entered, highlight the first destination.  
If the second destination, for example, is highlighted when destination guidance is started, the first destination is skipped.
  - "Start guidance"
- 📍 This symbol marks the active leg of the trip.

## Store the trip

Up to 30 trips can be stored in the trip list. If necessary, delete existing trips to be able to store new trips.

1. Open "Options".
2. "Store trip"
3. Enter the name.
4. "OK"

## Select the stored trip

1. "Navigation"
2. "Stored trips"
3. Select a stored trip.
4. "Start guidance"

## Reversing the direction of travel

Intermediate destinations are displayed in reverse order in the list.

1. "Map"
2.  "Guidance"
3. Open "Options".
4. "Reverse order of trip dest."

## Intermediate destination options

1. "Map"
2.  "Guidance"
3. "Display all trip destinations"
4. Select an intermediate destination.
  - ▷ "Edit destination"
  - ▷ "Reposition dest. in the trip": move an intermediate destination to another position in the list.
  - ▷ "Delete dest. in the trip"
  - ▷ "Go to next dest. in the trip"

Some options are not available for certain trips.

## Delete the stored trip

1. "Stored trips"
2. Highlight the desired trip.
3. Open "Options".
4. "Delete all trips" or "Delete trip"

## With the Professional navigation system: Open the last trip

1. "Navigation"
2. "Stored trips"
3. "Last trip"
4. "Start guidance"

## Destination guidance

### Starting destination guidance

1. "Navigation"
2. Make a destination entry, refer to page 154.
3. "Accept destination"
4. "Start guidance"
  - ▷ The route is shown on the Control Display.
  - ▷ The distance to the destination/intermediate destination and the estimated time of arrival are displayed in the map view.
  - ▷ The arrow view is shown in the instrument cluster, in the Head-up Display\*, and on the Control Display where appropriate.

### Terminating destination guidance

1. "Navigation"
2. "Map"
3.  "Guidance"
4. "Stop guidance"

### Continuing destination guidance

If the destination was not reached during the last trip, destination guidance can be resumed.

"Resume guidance"







## Route criteria

### General information

- ▷ The route calculated can be influenced by selecting certain criteria.
- ▷ The route criteria can be changed when the destination is entered and during destination guidance.

- ▷ Road types are part of the navigation data and are taken into consideration when planning a route, e.g., avoid highways.
- ▷ The recommended route may differ from the route you would take based on personal experience.
- ▷ The settings are stored for the remote control currently in use.
- ▷ Destination guidance with traffic bulletins, refer to page 167.

## Changing the route criteria

1. "Navigation"
2. "Map"
3.    "Route preference"
4. Select the criterion:
  - ▷  "Fast route": time-optimized route, being a combination of the shortest possible route and the fastest roads.
  - ▷  "Efficient route": optimized combination of the fastest and shortest route.
  - ▷  "Short route": short distance, irrespective of how fast or slow progress will be.
  - ▷ "Alternative routes": if available, alternative routes are suggested during active route guidance. The individual suggestions are highlighted in color.

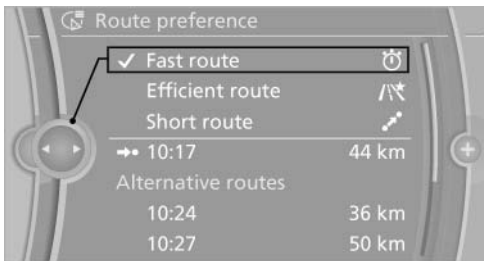

5. Specify additional criteria for the route, if necessary:
  - ▷ "Avoid highways": highways are avoided wherever possible.
  - ▷ "Avoid toll roads": toll roads are avoided wherever possible.

- ▷ "Avoid ferries": ferries are avoided where possible.

## Route

Different views of the route are available during destination guidance:

- ▷ Arrow view in the instrument cluster and on the Control Display.
- ▷ List of route sections.
- ▷ Map view, refer to page 163.
- ▷ Arrow view in the Head-up Display\*, refer to page 125.

## Arrow view

The following information is displayed during destination guidance:

- ▷ Large arrow: current direction of travel.
- ▷ Small arrow: indicates the next change in direction.
- ▷ Intersection view.
- ▷ Lane information.
- ▷ Traffic bulletins.
- ▷ Distance to the next change in direction.
- ▷ Street name at the next change in direction.

## Lane information

On multi-lane roads, the recommended lanes are marked in the arrow view by a triangle.

- ▷ Solid triangle: best lane.
- ▷ Empty triangle: possible lane. However, another lane change may be needed shortly.

## Displaying list of route sections

When the destination guidance is started, a list of route sections can be displayed. The driving distances and traffic bulletins are displayed for each route section.

1. "Navigation"
2. "Route information"
3. Mark route section.

The route section is displayed on the split screen.

## Bypassing a section of the route

Calculate a new route for a route section.

1. "Navigation"
2. "Route information"
3. "New route for"

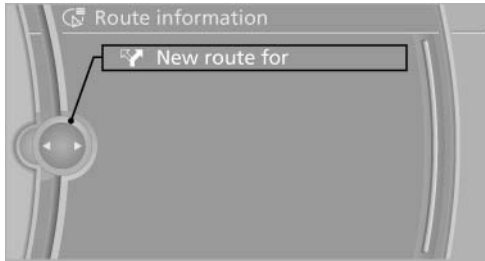

4. Turn the controller. Enter the number of kilometers within which you would like to return to the original route.
5. Press the controller.

## Resuming the original route

If the route section should no longer be bypassed:

1. "Navigation"
2. "Route information"
3. "New route for:"
4. "Remove blocking"

## Gas station recommendation

The remaining range is calculated, and if necessary gas stations along the route are displayed.

1. "Navigation"
2. "Route information"
3. "Recommended refuel"  
A list of the gas stations is displayed.
4. Highlight a gas station.  
The position of the gas station is displayed on the split screen.
5. Select the gas station.

6. Select the symbol.
7. "Start guidance": destination guidance to the selected gas station is started.  
"Add as another destination": the gas station is added to the route.

## Switching spoken instructions on/off

The setting is stored for the remote control currently in use.

1. "Navigation"
2. "Map"
3. "Voice instructions"

## Repeating spoken instructions

1. "Navigation"
2. "Map"
3. Highlight the symbol.
4. Press the controller twice.

## Volume of spoken instructions

Turn the volume button while giving an instruction until the desired volume is set.

## Saving the spoken instructions on the programmable memory buttons

The function for switching the spoken instructions on/off can be stored on a programmable memory button, refer to page 23, for quick access.

## Map view

### Selecting the map view

1. "Navigation"
2. "Map"

## At a glance

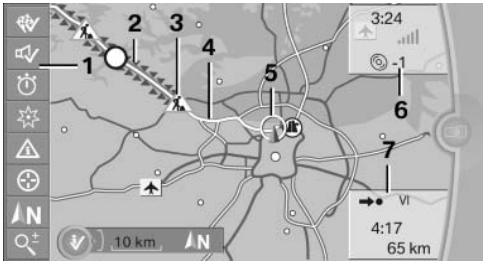

- 1 Function bar
- 2 Route section with traffic obstruction
- 3 Traffic sign for traffic obstruction
- 4 Planned route
- 5 Current location
- 6 Upper status field
- 7 Lower status field

## Lines in the map

Streets and routes are displayed in different colors and styles depending on their classification. Dashed lines represent railways and ferry connections. Country borders are indicated by thin lines.

## Traffic obstructions

Small triangles along the planned route indicate route sections with traffic obstructions, depending on the map scale. The direction of the triangles indicates the direction of the obstruction.

The traffic signs indicate the significance of the obstruction.

- ▷ Red traffic sign: the obstruction affects the planned route or direction.
- ▷ Gray traffic sign: the obstruction does not affect the planned route or direction.

Traffic bulletins, refer to page [165](#).

## Planned route

After destination guidance is started, the planned route is displayed on the map.

## Status fields

Show/hide: press the controller.

- ▷ Upper status field: time, telephone, and entertainment details.
- ▷ Lower status field: symbol for active destination guidance, status of traffic bulletins, time of arrival, and distance to destination.

## Function bar

The following functions are available in the function bar:

Symbol	Function
	Start/end destination guidance.
	Switch spoken instructions on/off.
	Change the route criteria.
	Search for a special destination.
	Display the traffic bulletins.
	Interactive map.
	Set the map view.
	Change the scale.

To change to the function bar, move the controller to the left.

## Changing the map section

- ④ "Interactive map"
- ▷ To shift the map: move the controller in the required direction.
- ▷ To shift the map diagonally: move the controller in the required direction and turn it.

## Changing the scale

1. Select the symbol.
2. To change the scale: turn the controller.

## Automatically scaled map scale

In the map view facing north, turn the controller in any direction until the AUTO scale is displayed. The map shows the entire route between the current location and the destination.



## Settings for the map view

The settings are stored for the remote control currently in use.

1. "Navigation"
2. "Map"
3. Open "Options".
4. "Settings"

Set the map view.

- ▷ "Day/night mode"  
Select and create the necessary settings depending on the light conditions.  
"Traffic conditions/gray map" active: the setting is disregarded.
- ▷ With the Professional navigation system: "Satellite images"  
Depending on availability and resolution, satellite images\* are displayed in a scale of approx. 1 mile to 600 miles/2 km to 1,000 km.
- ▷ "Perspective view in 3D"  
Prominent areas that are contained in the navigation data are displayed on the map in 3D.
- ▷ "Traffic conditions/gray map"  
The map is optimized for displaying traffic bulletins, refer to page 165. Symbols for the special destinations are no longer displayed.

## Map view for split screen

The map view can be selected for the split screen independently from the main screen.

1. Open "Options".
2. "Split screen"
3. Move the controller to the right repeatedly until the split screen is selected.
4. Select "Split screen content" or the scale.
5. Select the map view.
  - ▷ "Arrow display"
  - ▷ "Map facing north"
  - ▷ "Map direction of travel"
  - ▷ "Map view with perspective"

- ▷ "Position"
  - ▷ "Exit ramp view": selected blind drive-ways are displayed three dimensionally. Setting in some cases will affect the display in the Head-Up Display\*.
  - ▷ "Traffic conditions/gray map"
6. To change the scale: select the split screen and turn the controller.

## Traffic bulletins\*

### At a glance

- ▷ Display the traffic bulletins from radio stations that broadcast the TI Traffic Information of a traffic information service. Information on traffic obstructions and hazards is updated continuously.

Certain BMW models equipped with navigation have the capability to display real-time traffic information. If your system has this capability the following additional terms and conditions apply:

An End-User shall no longer have the right to use the Traffic Data in the event that the End-User is in material breach of the terms and conditions contained herein.

A. Total Traffic Network, a division of Clear Channel Broadcasting, Inc. ("Total Traffic Network") holds the rights to the traffic incident data and RDS-TMC network through which it is delivered. You may not modify, copy, scan or use any other method to reproduce, duplicate, republish, transmit or distribute in any way any portion of traffic incident data. You agree to indemnify, defend and hold harmless BMW of North America, LLC. ("BMW NA") and Total Traffic Network, Inrix, Inc (and their affiliates) against any and all claims, damages, costs or other expenses that arise directly or indirectly out of (a) your unauthorized use of the traffic incident data or the RDS-TMC network, (b) your violation of this directive and/or (c) any unauthorized or unlawful activities by you in connection herewith.

B. Total Traffic Network traffic data is informational only. User assumes all risk of use. Total Traffic Network, BMW NA, and their suppliers make no representations about content, traffic and road conditions, route usability, or speed.

C. The licensed material is provided to licensee “as is,” and “where is”. Total Traffic Network, including, but not limited to, any and all third party providers of any of the licensed material, expressly disclaims, to the fullest extent permitted by law, all warranties or representations with respect to the licensed material (including, without limitation, that the licensed material will be error-free, will operate without interruption or that the traffic data will be accurate), express, implied or statutory, including, without limitation, the implied warranties of merchantability, non-infringement fitness for a particular purpose, or those arising from a course of dealing or usage of trade.

D. Neither Total Traffic Network, Inrix, Inc. or BMW NA will be liable to you for any indirect, special, consequential, exemplary, or incidental damages (including, without limitation, lost revenues, anticipated revenues, or profits relating to the same) arising from any claim relating directly or indirectly to use of the traffic data, and even if Total Traffic Network, Inrix, Inc., or BMW NA are aware of the possibility of such damages. These limitations apply to all claims, including, without limitation, claims in contract and tort (such as negligence, product liability and strict liability). Some states do not allow the exclusion or limitation of incidental or consequential damages, so those particular limitations may not apply to you.

- ▶ The traffic bulletins are indicated on the map by symbols.
- ▶ The traffic bulletins for the surrounding area are stored in a list.

 The symbol in the function bar of the map view turns red if there are traffic bulletins that affect the calculated route.

## Switching the reception on/off

1. "Navigation"
2. Open "Options".
3. "Receive Traffic Info"

## Open the traffic bulletins

1. "Navigation"
2. "Map"
3.  "Traffic Info"

First the traffic bulletins for the calculated route are displayed.

The traffic bulletins are sorted by their distance from the current position of the vehicle.

4. Select a traffic bulletin.  
 "More information": display additional information.
5. Scroll to the next or previous traffic bulletin if required.

## Traffic bulletins on the map

"Traffic conditions/gray map" Active: indication on the control display is switched to shades of gray. This enables a better view of the traffic bulletins. The day/night mode is disregarded in this setting. Symbols and special destinations are not displayed.

1. "Navigation"
2. "Map"
3. Open "Options".
4. "Settings"
5. "Traffic conditions/gray map"

## Symbols in the map view

Depending on the scale of the map and the location of the traffic obstruction along the route, the symbols for the traffic obstructions are displayed.

## Additional information in the map view

Depending on the map scale, a traffic obstruction's length, direction, and impact are displayed

in the map using triangles or gray bars along the calculated route.

- ▷ Red: congestion.
- ▷ Orange: stop-and-go traffic.
- ▷ Yellow: heavy traffic.
- ▷ Green: clear roads.
- ▷ Gray: general traffic bulletins, e.g., construction site.

The displayed information depends on the particular traffic information service.

## Filtering traffic bulletins

You can set which traffic bulletins appear on the map.

1. "Navigation"
2. "Map"
3. Open "Options".
4. "Traffic Info categories"
5. Select the desired categories.



Traffic bulletins of the selected category are displayed on the map.

- ▷ Traffic bulletins that are relevant to the route are always shown.
- ▷ For your own safety, traffic bulletins that notify you of potentially dangerous situations, such as wrong-way drivers, cannot be hidden.

## Destination guidance with traffic bulletins

### Semi-dynamic destination guidance

When traffic bulletin reception is switched on, semi-dynamic destination guidance is active.



The destination guidance system takes the available traffic information into account. A message is displayed depending on the route, the traffic bulletins, and the possible detour routes. A detour is suggested in the event of a traffic obstruction. In addition, distance and time differences between the original route and the detour are displayed.

To accept the detour:

1. "Detour"

In the event of special hazards, e.g., objects on the road, a message is displayed without a detour suggestion.

Detours can also be accepted if the traffic messages are called up in the list.

1. "Navigation"
2. "Map"
3.  "Traffic Info"
4. "Detour information"
5.  "Detour"

## Dynamic destination guidance

The route is automatically changed in the event of traffic obstructions.

- ▷ The system does not point out traffic obstructions along the original route.
- ▷ Traffic bulletins continue to be displayed on the map.
- ▷ Depending on road type and the kind and extent of the traffic obstruction, the calculated route may lead through the traffic obstruction.
- ▷ Dangerous situations are displayed regardless of the setting.

To activate dynamic destination guidance:

1. "Navigation"
2. Open "Options".
3. "Dynamic guidance"

## Navigation data

### Information on the navigation data

1. "Navigation"
2. Open "Options".
3. "Navigation system version": information on the data version is displayed.

### Updating the navigation data

#### General information

Navigation data and authorization codes are available from your service center. Navigation data are stored in the vehicle and can be updated.

- ▷ Depending on the data volume, a data update may take several hours.
- ▷ Update during the trip to preserve battery.
- ▷ During the update, only the basic functions of the navigation system are available.
- ▷ The status of the update can be viewed.
- ▷ The system restarts after the update.
- ▷ The data carrier with the navigation data can be removed after the update is complete.

#### Perform an update

1. Insert the navigation DVD into the DVD player with the labeled side facing up.
2. Follow the instructions on the Control Display.
3. Enter the authorization code of the navigation DVD and change the DVD if needed.

After interrupting your trip, follow the instructions on the Control Display.

#### Viewing the status

1.  Press the button.
2. "Navigation update"

## What to do if...

- ▷ The current transmission position cannot be displayed?

The vehicle is located in an unrecognized region, is in a poor reception area, or the system is currently determining the position. Reception is usually best when you have an unobstructed view of the sky.

- ▷ The destination without street information is not used for route guidance?

When city has been input, no downtown can be determined.

Input any street in the selected city and start destination guidance.

- ▷ The destination is not used for route guidance?

The destination data is not contained in the navigation data. Select a destination that is as close as possible to the original.

- ▷ Letters for destination input cannot be selected?

The stored data do not contain the data of the destination.

Select a goal that is as close as possible to the original.

- ▷ Is the map displayed in shades of gray?

"Traffic conditions/gray map" Active: indication on the control display is switched to shades of gray. This enables a better view of the traffic bulletins.

- ▷ Spoken instructions are no longer output during route guidance in front of intersections?

The area has not yet been fully recorded, or you have left the recommended route and the system requires a few seconds to calculate a new route suggestion.







## Entertainment

The chapter helps assure your enjoyment when receiving radio and television stations and playing CDs, DVDs and tracks from the music collection.

# Tone

## General information

The sound settings are stored for the remote control currently in use.

## Treble, bass, balance, and fader

- ▷ "Treble": treble adjustment.
- ▷ "Bass": depth adjustment.
- ▷ "Balance": left/right volume distribution.
- ▷ "Fader": front/rear volume distribution.

## Setting treble, bass, balance, and fader

1. "CD/Multimedia", "Radio" or "Settings"
2. "Tone"

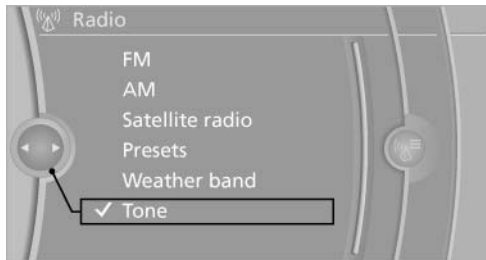

3. Select the desired tone settings.



4. To adjust: turn the controller.
5. To store: press the controller.

## Equalizer\*

Setting for individual audio frequency ranges.

## Adjusting the equalizer

1. "CD/Multimedia", "Radio" or "Settings"
2. "Tone"
3. "Equalizer"
4. Select the desired setting.



5. To adjust: turn the controller.
6. To store: press the controller.

## Multi-channel playback, surround\*

Choose between stereo and multi-channel playback, surround.

## Setting multi-channel playback, surround

1. "CD/Multimedia", "Radio" or "Settings"
2. "Tone"
3. "Surround"

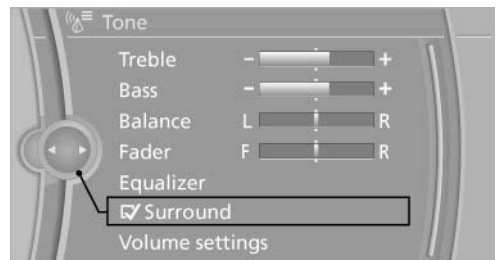



When surround is activated, multi-channel playback is simulated when a stereo audio track is played.

## Volume

- ▷ "Speed volume": speed-dependent volume control.
- ▷ "PDC": volume of the PDC signal\* compared to the entertainment sound output.
- ▷ "Gong": volume of the signal, such as the safety belt reminder, compared to the entertainment sound output.
- ▷ "Microphone": volume of the microphone\* during a phone call.
- ▷ "Loudspeak.": volume of the loudspeakers\* during a phone call.

The following volumes are only stored for the respective paired telephone: "Microphone", "Loudspeak.".

### Adjusting the volume

1. "CD/Multimedia", "Radio" or "Settings"
2. "Tone"
3. "Volume settings"
4. Select the desired volume setting.

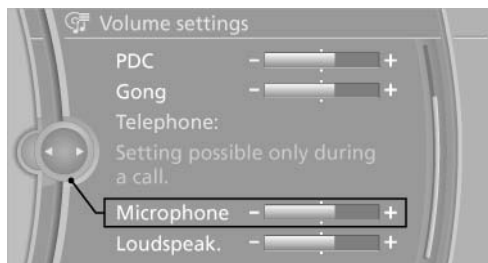

5. To adjust: turn the controller.
6. To store: press the controller.

### Resetting the tone settings

1. "CD/Multimedia", "Radio" or "Settings"
2. "Tone"
3. "Reset"

## Opening the tone settings in the Options menu\*

1. "CD/Multimedia" or "Radio"
2. If necessary, select additional entries, for example, "FM" or "CD/DVD".
3. Open "Options".
4. "Tone"
5. Set the desired tone.

# Radio

## Controls

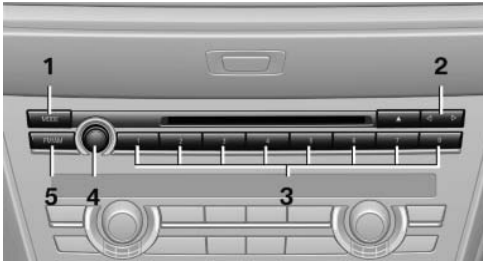

- 1 Change entertainment sources
- 2 Change station/track
- 3 Programmable memory buttons
- 4 Volume, on/off
- 5 Change wave band

## Sound output

### Switching on/off

When the ignition is switched off: press ON/OFF button on the radio.

### Muting

When the ignition is switched on or the engine is running: press the ON/OFF button on the radio.

## AM/FM station

### Selecting a station

1. "Radio"
2. "FM" or "AM"

3. Select the desired station.

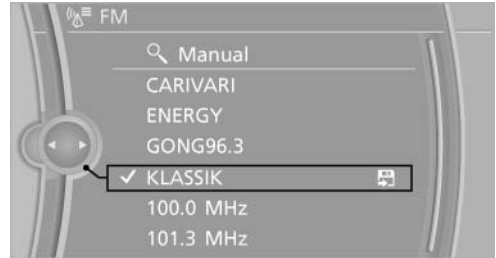

All saved stations are stored for the remote control currently in use.

### Changing the station via the button

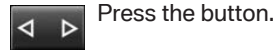

Press the button.

### Storing a station

1. "Radio"
2. "FM" or "AM"
3. Highlight the desired station.

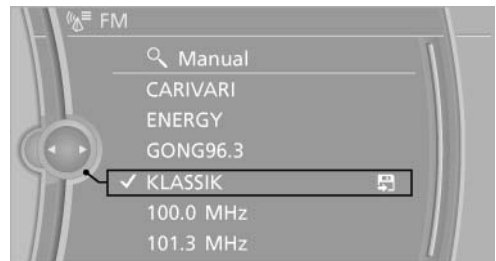

4. Press the controller for an extended period.
5. Select the desired memory location.

The stations are stored for the remote control currently in use.

The stations can also be stored on the programmable memory buttons, refer to page 23.

### Selecting a station manually

Station selection via the frequency.

1. "Radio"
2. "FM" or "AM"
3. "Manual"
4. To select the frequency: turn the controller.



To store the station: press the controller for an extended period.

### RDS\*

RDS broadcasts additional information, such as the station name, in the FM wave band. When playing a station with multiple frequencies, the system automatically switches to the frequency with the best reception, if needed.

### Switching the RDS on/off

1. "Radio"
2. "FM"
3. Open "Options".
4. "RDS"



The setting is stored for the remote control currently in use.

### HD Radio™ reception\*

Many stations broadcast both analog and digital signals.

License conditions

HD Radio™ technology manufactured under license from iBiquity Digital Corp. U. S. and Foreign Patents. HD Radio™ and the HD and HD Radio logos are proprietary trademarks of iBiquity Digital Corp.

### Activating/deactivating digital radio reception

1. "Radio"
2. "FM" or "AM"
3. Open "Options".
4. "HD Radio Reception"

The setting is stored for the remote control currently in use.

 This symbol is displayed in the status line when the audio signal is digital.

In areas in which the station is not continuously received in digital mode, the playback switches between analog and digital reception. Due to time delayed broadcasting, there may be repetitions or interruptions. In this case, switch off digital radio reception.

### Displaying additional information

Some stations broadcast additional information on the current track, such as the name of the artist.

1. Select the desired station.
2. Open "Options".
3. "Station info"

### Selecting a substation

 This symbol indicates that a main station also broadcasts additional substations. The station name of the main station ends in HD1. Station names of the substations end in HD2, HD3, etc.

1. Select the desired station.
2. Press the controller.
3. Select the substation.

When reception is poor, the substation is muted for several seconds. If reception is interrupted for an extended period, it switches back to the main station.

## Weather Band\*

### General information

The availability of the Weather Band and the number of available channels can vary depending on the region.

### Switching on the Weather Band

1. "Radio"
2. "Weather band"
3. Select the desired channel.

### Additional information

Weather Band is a service of the National Oceanic and Atmospheric Administration (NOAA). Additional information on the Internet: [www.nws.noaa.gov](http://www.nws.noaa.gov).

## Satellite radio\*

### General information

The channels are offered in predefined packages. The packages must be enabled by telephone.

### Navigation bar overview

Symbol	Function
	Change the list view.
	Select the category.
	Direct channel entry
	Timeshift
	Open the My Favorites category/ open a favorite.
	Manage the favorites.
	Traffic Jump

The functions of the navigation bar symbols can also be stored on the programmable memory buttons, refer to page 23.

## Managing a subscription

To be able to enable or unsubscribe from the channels, you must have reception. It is usually at its best when you have an unobstructed view of the sky. The channel name is displayed in the status line.

### Enabling channels

The Unsubscribed Channels category contains all disabled channels.

1. "Radio"
2. "Satellite radio"
3. "Category"



4. Select the Unsubscribed Channels category.
5. Select the desired channel.  
The phone number and an electronic serial number, ESN, are displayed.
6. Select the phone number to have the channel enabled.



You can unsubscribe from the channels again via this phone number.

### Unsubscribing from channels

1. "Radio"
2. "Satellite radio"

3. Open "Options".
4. "Manage subscription"

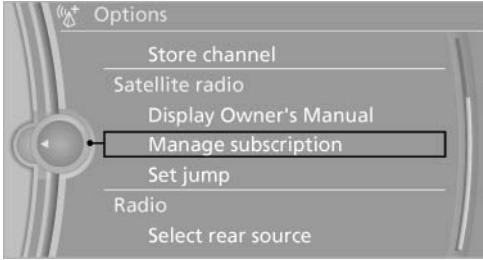

5. The phone number and an electronic serial number, ESN, are displayed.
6. Call Sirius to unsubscribe from the channels.

### Selecting channels

You can only listen to enabled channels.

The selected channel is stored for the remote control currently in use.

### Via iDrive

1. "Radio"
2. "Satellite radio"
3. Select "All channels" or the desired category.
4. Select the desired channel.



### Via the buttons on the center console



- Press the button.  
The next channel is selected.

### Via direct channel entry

1. "Radio"
2. "Satellite radio"
3.  "Set channel"
4. Turn the controller until the desired channel is reached and press the controller.

### Storing a channel

1. "Radio"
2. "Satellite radio"
3. If necessary, open "All channels" or the desired category.
4. Select the desired channel.
5. Press the controller again.
6. Press the controller again to confirm the highlighted channel.

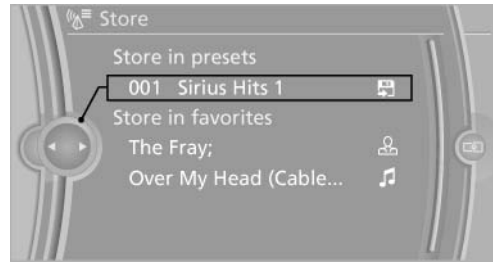

7. Select the desired memory location.



The channels are stored for the remote control currently in use.

The channels can also be stored on the programmable memory buttons, refer to page 23.

### Changing the list view

The list view changes every time the first symbol on the navigation bar is pressed.

Information on the channel is displayed.

Symbol	Meaning
	Channel name
	Artist
	Track

## Selecting a category

1. "Radio"
2. "Satellite radio"
3.  "Category"
4. Select the desired category.

## Timeshift

Approx. one hour of the program being broadcast on the channel currently being listened to is stored in a buffer. Prerequisite: the signal must be available.

The stored audio track can be played with a delay following the live broadcast. When the buffer is full, the older tracks are overwritten. The buffer is cleared when a new channel is selected.

## Opening the timeshift function



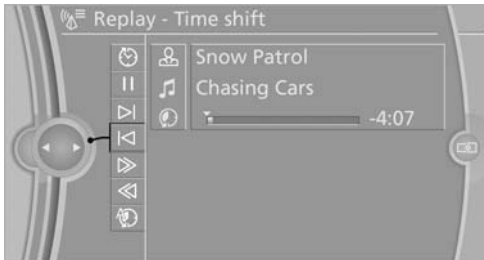

1. "Radio"
2. "Satellite radio"
3.  "Replay - Time shift"





- ▷ The red arrow shows the current playback position.
- ▷ The time difference to the live broadcast is displayed next to the buffer bar.

For live transmissions: "live".

## Timeshift menu

Symbol	Function
	Go to the live broadcast
	Playback/pause
	Next track
	Previous track

Symbol	Function
	Fast forward
	Reverse
	Automatic timeshift deactivated/activated



## Automatic timeshift

When the function is activated, audio playback is stopped automatically in the event of:

- ▷ Incoming and outgoing telephone calls.
- ▷ Activation of the voice activation system.
- ▷ Muting.

The audio playback then continues with a time delay.

To activate:

1. "Radio"
2. "Satellite radio"
3.  "Replay - Time shift"
4.  "Automatic time shift"

To deactivate:  "Automatic time shift".

## Storing favorites

Up to 30 favorites can be stored in the favorites list. Available favorites are artist, track, game, league, and team.

## Storing the artist, track, or game

It is only possible to store favorites that are currently being broadcast. The channel information must be available.

1. "Radio"
2. "Satellite radio"
3. If necessary, open "All channels" or the desired category.
4. Select the desired channel.
5. Press the controller again.
6. Select the artist, track, or game.

## Storing the league or team

Leagues or teams can be added to the favorites from a selection list.

1. "Radio"
2. "Satellite radio"
3. ☆+ "Manage favorites"
4. "Add sports information"



5. Select the league.
6. Select "Add all teams" or the desired team.

## Opening the favorites

If an activated favorite is played back, the following message appears for approx. 20 seconds: "Favorite alert!".

☆☆ "Favorites"

Select the symbol while the message is shown.



The displayed favorite is played.

If there is no message, the system changes to the My Favorites category. All favorites currently being broadcast can be selected from a list.

## Managing the favorites

### Activating/deactivating the favorites

Favorites can be activated and deactivated globally and individually.

1. "Satellite radio"
2. ☆+ "Manage favorites"
3. Select "Activate alert" or the desired favorites.

The setting is stored for the remote control currently in use.

### Deleting favorites

1. "Satellite radio"
2. ☆+ "Manage favorites"
3. Highlight the desired favorite.
4. Open "Options".
5. "Delete entry"

### Traffic Jump

Traffic and weather information for a selected region is broadcast every few minutes.

### Selecting a region

1. "Radio"
2. "Satellite radio"
3. Open "Options".
4. "Set jump"
5. Select the desired region.

The region is stored for the remote control currently in use.

### Activating/deactivating the jump

1. "Radio"
2. "Satellite radio"
3. ↻ "Jump to:"

Information for the selected region is broadcast as soon as it is available.

A new panel opens.

Canceling the Traffic Jump: "Cancel".

Symbol	Meaning
↻	Information will be broadcast shortly.
↻	Information is currently being broadcast.

Select one of the symbols to deactivate Traffic Jump.

## Automatic update

About twice a year, Sirius performs an update of the channel names and positions. The update takes place automatically and may take several minutes.

## Notes

- ▷ Reception may not be available in some situations, such as under certain environmental or topographic conditions. The satellite radio has no influence on this.
- ▷ The signal may not be available in tunnels or underground garages next to tall buildings or near trees, mountains or other powerful sources of radio interference.

## Stored stations

### General information

It is possible to store up to 40 stations.

### Calling up a station

1. "Radio"
2. "Presets"
3. Select the desired station.

### Storing a station

The station currently selected is stored.

1. "Radio"
2. "Presets"

### 3. "Store station"



### 4. Select the desired memory location.

The list of stored stations is stored for the remote control currently in use.

The stations can also be stored on the programmable memory buttons, refer to page 23.

## Deleting a station

1. "Radio"
2. "Presets"
3. Select the desired station.
4. Open "Options".
5. "Delete entry"



# CD/multimedia

## Controls

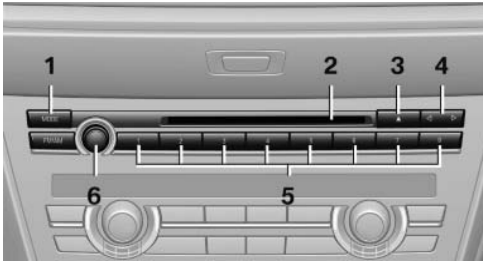

- 1 Change the entertainment source
- 2 CD/DVD\* drive
- 3 Eject CD/DVD
- 4 Change station/track
- 5 Programmable memory buttons
- 6 Volume, on/off

## Sound output

### Switching on/off

When the ignition is switched off: press ON/OFF button on the radio.

### Muting

When the ignition is switched on or the engine is running: press the ON/OFF button on the radio.

## CD/DVD\*

### Playback

#### Filling the CD/DVD\* player

Insert the CD/DVD with the printed side up. Playback begins automatically.

Reading can take a few minutes with compressed audio files.

## Starting playback

A CD/DVD is located in the CD/DVD player or DVD changer\*.

1. "CD/Multimedia"
2. "CD/DVD"
3. Select the desired CD or DVD.



Symbol	Meaning
	CD/DVD* player
	DVD changer*
	CD/DVD player, rear*

## Playable formats

- ▶ DVD: DVD-ROM, DVD-R, DVD+R, DVD-RW, DVD+RW, DVD-R DL, DVD+R DL, DVD audio (video part only), DVD video\*.
- ▶ CD: CD-ROM, CD-R, CD-RW, CD-DA, VCD\*, SVCD\*.
- ▶ Compressed audio files: MP3, WMA, AAC\*, M4A\*.

## Audio playback

### Selecting the track using the button

Press the button repeatedly until the desired track is played.

## Selecting a track via iDrive

### Audio CDs



Select the desired track to begin playback.

### CDs/DVDs\* with compressed audio files

Depending on the data, some letters and numbers of the CD/DVD may not be displayed correctly.

1. Select the directory if necessary.  
To change to a higher level directory: move the controller to the left.

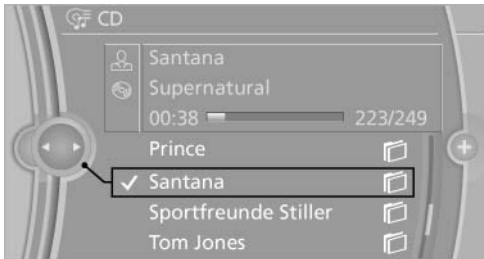

2. Select the desired track to begin playback.

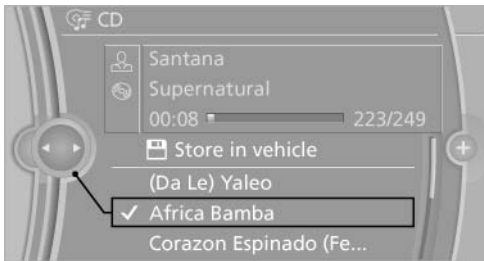

## Displaying information on the track

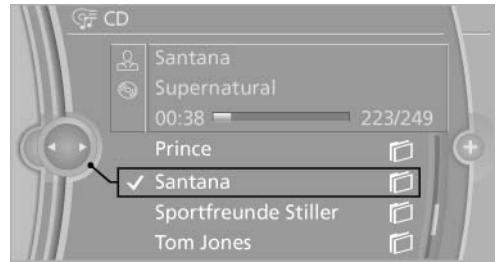

If information about a track has been stored, it is displayed automatically:

- ▶ Interpret.
- ▶ Album track.
- ▶ Number of tracks on the CD/DVD\*.
- ▶ File name of track.

### Random playback

1. "CD/Multimedia"
2. "CD/DVD"
3. Select the desired CD or DVD\*.
4. Open "Options".
5. "Random"

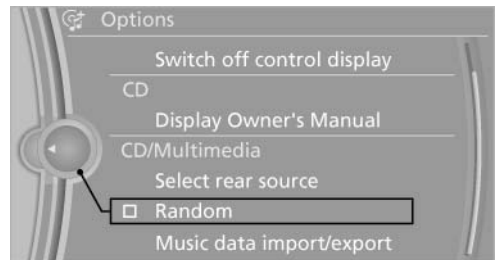

CDs/DVDs\* with compressed audio files: All tracks in the selected directory are played in random order.

Random mode is switched off when the audio source is changed and the ignition is switched off.

### Fast forward/reverse

 Press and hold the button.

## Automatic repeat\*

The selected CDs or DVDs are repeated automatically.

## Video playback\*

### Country codes

Only DVDs with the code of the home region can be played back; also refer to the information on the DVD.

Code	Region
1	USA, Canada
2	Japan, Europe, Middle East, South Africa
3	Southeast Asia
4	Australia, Central and South America, New Zealand
5	Northwest Asia, North Africa
6	China
0	All regions

## Playback

The video image is displayed on the front Control Display up to a speed of approx. 2 mph/3 km/h; in some countries, it is only displayed if the parking brake is set or if the automatic transmission is in position P.

### DVD video

1. "CD/Multimedia"
2. "CD/DVD"

3. Select a DVD with video content.

4. **DVD** "DVD menu"



### VCD/SVCD

1. "CD/Multimedia"
2. "CD/DVD"
3. Select a CD with video content.
4. "Select track"
5. Select the desired track.

### Video menu

To open the video menu: turn the controller during playback.

Press the controller when "Back" is displayed.

Symbol	Function
<b>DVD</b>	Open the DVD menu.
	Start playback.
	Pause
	Stop
	Next chapter
	Previous chapter
	Fast forward
	Reverse

In fast forward/reverse: the speed increases every time the controller is pressed. To stop, start playback.

### DVD menu

1. If necessary, turn the controller to open the video menu.

## 2. **DVD** "DVD menu"

The DVD menu is displayed. The display depends on the contents of the DVD.

## 3. To select menu items: move the controller and press it.

To change to the video menu: turn the controller and press it.

## DVD/VCD settings

For some DVDs, settings can only be made via the DVD menu; refer also to the information on the DVD.

### Selecting the language\*

The languages that are available depend on the DVD.

1. Turn the controller during playback.
2. Open "Options".
3. "Audio/language"

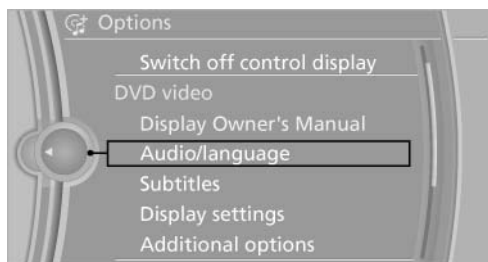

4. Select the desired language.

### Selecting the subtitles\*

The subtitles that are available depend on the DVD.

1. Turn the controller during playback.
2. Open "Options".

## 3. "Subtitles"

4. Select the desired language or "Do not display subtitles".



### Setting the brightness, contrast and color

1. Turn the controller during playback.
2. Open "Options".
3. "Display settings"
4. "Brightness", "Contrast" or "Color"

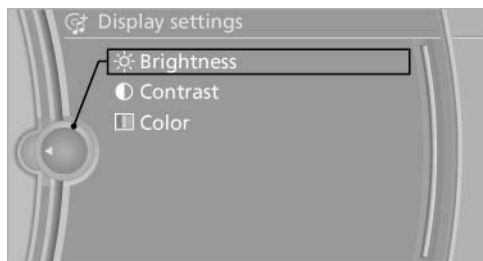

5. Turn the controller until the desired setting is reached and press the controller.

### Selecting the zoom

Display the video image on the entire screen.

1. Turn the controller during playback.
2. Open "Options".

- "Additional options"
- "Zoom mode"

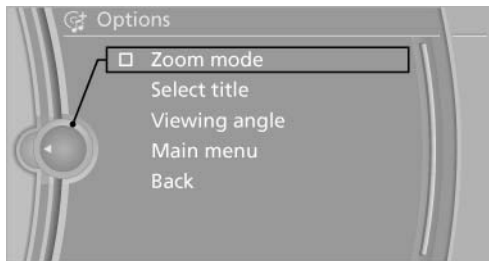

### Selecting a track

DVD video:

- Turn the controller when the DVD menu is displayed.
- Open "Options".
- "Additional options"
- "Select title"
- Select the desired track.

VCD/SVCD:

- "Select track"
- Select the desired track.

### Selecting the camera angle\*

The availability of a different camera angle depends on the DVD and the current DVD track.

- Turn the controller during playback.
- Open "Options".
- "Additional options"
- "Viewing angle"
- Select the desired camera angle.

### Opening the main menu, back

These functions are not contained on every DVD. Therefore, they may not be available for use.

## DVD changer\*

### In the glove compartment

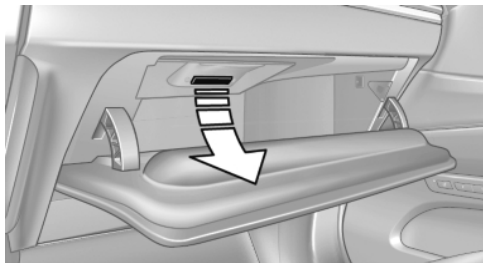

Pull down the release cover.

The DVD changer tilts down.

To close: fold the DVD changer up until it engages.



Fold up the DVD changer

Always fold the DVD changer back up after filling and emptying it; otherwise, the DVD changer could be damaged. ◀

### Controls and displays

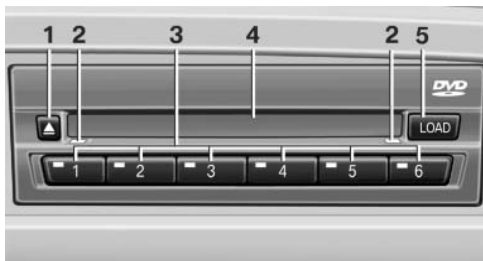

- Empty DVD compartments
- LED on DVD slot
- Buttons for DVD compartments
- DVD slot
- Fill DVD compartments

### Filling the DVD compartments individually

- Press the button.

The LED on the first empty compartment flashes.

2. Select another compartment if necessary.
3. Wait for the LEDs on the DVD slot to flash.
4. Insert a single CD or DVD in the middle.

The CD/DVD is drawn in automatically and placed into the selected compartment.



#### Sliding in CDs/DVDs

Do not insert the CD/DVD until the LEDs on the DVD slot are flashing; otherwise, the CD/DVD or the DVD changer could be damaged.

Do not continue to push on the CD/DVD; this may cause it to jam and prevent it from being able to eject again. ◀

### Filling all empty DVD compartments

1.  Hold the button down.

The LEDs on the empty CD compartments flash.

2. Wait for the LEDs on the DVD slot to begin flashing and then insert each CD or DVD into the center of the slot.

The CDs/DVDs are drawn in automatically and placed into the vacant compartments.



#### Sliding in CDs/DVDs

Do not insert the CD/DVD until the LEDs on the DVD slot are flashing; otherwise, the CD/DVD or the DVD changer could be damaged.

Do not continue to push on the CD/DVD; this may cause it to jam and prevent it from being able to eject again. ◀

After they are inserted, it may take several minutes for the CDs/DVDs to be read in.

### Removing a single CD/DVD

1.  Press the button.

2. Select the DVD compartment.

The CD/DVD is partially ejected.

3. Remove the CD/DVD.

### Removing all CDs/DVDs

1.  Hold the button down.
2. Remove the CDs/DVDs.

### Malfunctions

If all LEDs on the DVD changer are flashing rapidly, a malfunction has occurred.

To eliminate the malfunction:

1. Press one of the buttons:



The CD/DVD last inserted is ejected.

2. Remove the CD/DVD.

The DVD changer is functional again after the LEDs stop flashing rapidly.

### Audio playback\*

The audio track of a DVD can be played back even if video playback is not possible in the vehicle.

Only the main film without the previews or extras can be played back.

### Starting playback

A DVD is located in the DVD changer.

1. "CD/Multimedia"
2. "CD/DVD"
3. Select the desired DVD.

### Selecting a chapter using the button



Press the button repeatedly until the desired chapter is played.

### Selecting a chapter using iDrive

1. "CD/Multimedia"
2. "CD/DVD"
3. Select the desired DVD.
4. Select the desired chapter.

## Fast forward/reverse



Press and hold the button.

## Selecting the language\*

The languages that are available depend on the DVD.

1. "CD/Multimedia"
2. "CD/DVD"
3. Select the desired DVD.
4. Open "Options".
5. "Audio/language"
6. Select the desired language.

## Notes

### CD/DVD player and changer



Do not remove the cover

BMW CD/DVD players and changers are officially designated Class 1 laser products. Do not operate if the cover is damaged; otherwise, severe eye damage may occur. ◀

### CDs and DVDs



Use of CDs/DVDs

- ▶ Do not use self-recorded CDs/DVDs with labels applied, as these can become detached during playback due to heat buildup and can cause irreparable damage to the device.
- ▶ Only use round CDs/DVDs with a standard diameter of 4.7 in/12 cm and do not play CDs/DVDs with an adapter, e.g., single CDs; otherwise, the CDs or the adapter may jam and no longer eject.
- ▶ Do not use combined CDs/DVDs, e.g., DVD Plus, as the CDs/DVDs can jam and will no longer eject. ◀

### General malfunctions

- ▶ CD/DVD changers and players have been optimized for performance in vehicles. In some instances they may be more sensitive

to faulty CDs/DVDs than stationary devices would be.

- ▶ If a CD/DVD cannot be played, first check whether it has been inserted correctly.

### Humidity

High levels of humidity can lead to condensation on the CD/DVD or the laser's scan lens, and temporarily prevent playback.

### Malfunctions involving individual CDs/DVDs

If malfunctions occur only with particular CDs/DVDs, this can be due to one of the following causes:

#### Home-recorded CDs/DVDs

- ▶ Possible reasons for malfunctions with home-recorded CDs/DVDs are inconsistent data creation or recording processes, or poor quality or old age of the blank CD/DVD.
- ▶ Only label CDs/DVDs on the upper side with a pen intended for this purpose.

### Damage

- ▶ Avoid fingerprints, dust, scratches and moisture.
- ▶ Store CDs/DVDs in a sleeve.
- ▶ Do not subject CDs/DVDs to temperatures over 122 °F/50 °C, high humidity or direct sunlight.

### CDs/DVDs with copy protection

CDs/DVDs are often provided with a copy protection feature by the manufacturer. This can mean that some CDs/DVDs cannot be played or can only be played to a limited extent.

### MACROVISION

This product contains copyrighted technology that is based on multiple registered US patents and the intellectual property of the Macrovision Corporation and other manufacturers. The use of this copy protection must be approved by Macrovision. Media protected by this product - unless otherwise agreed with Macrovision - may

only be used for private purposes. Copying of this technology is prohibited.

## DTS Digital Surround™

 Manufactured under license under U.S. Patent Numbers: 5,451,942; 5,956,674; 5,974,380; 5,978,762; 6,487,535 & and other patents granted and registered in the USA and worldwide. DTS and the logo are registered trademarks & DTS Digital Surround and the DTS logos are trademarks of DTS Inc. © DTS, Inc. All rights reserved.

## Music collection\*

### Storing music

#### General information

Music tracks from CDs/DVDs and USB devices can be stored in the music collection on a hard disc in the vehicle and played from there.

- ▶ Audio CD: tracks are converted into a compressed audio format. If available, information on the album, such as the artist, is stored as well.
- ▶ CD/DVD or USB device with compressed audio files: the entire content of the CD/DVD or the USB device is stored in the vehicle as an album. The WMA, MP3, M4A\*, and AAC\* formats are stored. Individual tracks and directories can be deleted later, Deleting a track and directory, refer to page 191.

Tracks with DRM copy protection can be stored but cannot be played back.



#### Backing up music data

Regularly back up the music data; otherwise, it could be lost if there is a fault on the hard disk. ◀

 Music recognition technology and related data are provided by Gracenote®. Gracenote is the industry standard in music recognition technology and related content delivery. For more information, please visit [www.gracenote.com](http://www.gracenote.com).

CD and music-related data from Gracenote, Inc., copyright © 2000-2009 Gracenote. Gracenote Software, copyright © 2000-2009 Gracenote. This product and service may practice one or more of the following U.S. Patents: #5,987,525; #6,061,680; #6,154,773, #6,161,132, #6,230,192, #6,230,207, #6,240,459, #6,330,593, and other patents issued or pending. Some services supplied under license from Open Globe, Inc. for U.S. Patent: #6,304,523.

### Storing from a CD/DVD

1. Insert a CD or DVD into the CD/DVD player.
2. "CD/Multimedia"
3. "CD/DVD"
4.  Select the symbol for the CD/DVD player.
5. "Store in vehicle"



The music collection is displayed and the first track of the CD/DVD is played back. During the storage process, the tracks are played in sequence.

Observe the following during the storage process:

Do not switch to the CD/DVD player and do not remove the CD/DVD from the CD/DVD player as this will interrupt the storage process. You can switch to the other audio sources without interrupting the storage process. Tracks from the current CD/DVD that have already been stored can be called up.

### Interrupting storage

1. "CD/Multimedia"
2. "CD/DVD"



### 3. "Storing..."



### 4. "Cancel storing"

The storage process is interrupted and can be continued at any time.

## Continuing the storage process

1. "CD/Multimedia"
2. "CD/DVD"
3. Select the symbol for the CD/DVD player.
4. "Continue storing"

Storage of the CD/DVD continues at the beginning of the track at which storage was interrupted.

## Album information

During storage, information such as the name of the artist is stored with the track, if this information is available in the vehicle database or on the CD.

To update the database, contact your service center.

## Storing from a USB device

To store music, a suitable device must be connected to the USB interface in the glove compartment.

- ▶ Suitable devices: USB mass storage devices, such as USB flash drives or MP3 players with a USB interface.
- ▶ Unsuitable devices: USB hard drives, USB hubs, USB memory card readers with multiple inserts, Apple iPod/iPhone. Music from the Apple iPod/iPhone can be played via the USB audio interface in the center armrest.

1. Connect the USB device to the USB interface in the glove compartment, refer to page 139.
2. "CD/Multimedia"
3. "Music collection"
4. Open "Options".
5. "Music data import/export"
6. "Import music (USB)"

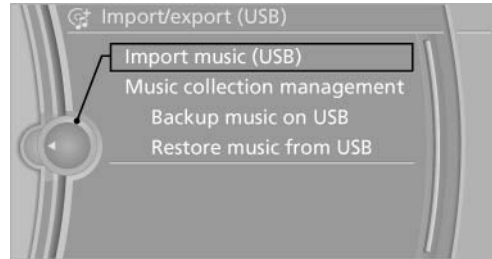

## Playing music

### Music search

All tracks for which additional information has been stored can be accessed by the music search. Tracks without additional information can be called up via the corresponding album, refer to page 190.

1. "CD/Multimedia"
2. "Music collection"
3. "Music search"



4. Select the desired category.



5. Select the desired entry:
  - ▶ Select "A-Z search", refer to page 24, and input the desired entry.
  - ▶ Select the desired entry from the list.
6. Select other categories if you wish.  
The tracks found are listed in alphabetical order.  
Not all categories need to be selected. For example, to search for all tracks by a certain artist, call up that artist only. All of the tracks by that artist are then displayed.
7. "Start play"  
The list of tracks is repeated automatically.

### Restarting the music search

"New search"

### Music search using spoken instructions\*

Instructions for the voice activation system, refer to page 25.

1.  Press the button on the steering wheel.
2. ›Music search‹
3. Open the desired category, e.g., ›Select artist.
4. Say the desired entry in the list.
5. Select other categories if you wish.

To select a track directly: ›Title ...‹.

Say the voice command and the name of the desired track in a single command.

### Current playback

The list of tracks that was generated last by the music search, or the album that was selected last.

1. "CD/Multimedia"
2. "Music collection"
3. "Current playback"



4. Select the desired track, if necessary.



### Top 50

The 50 most frequently played tracks.

1. "CD/Multimedia"
2. "Music collection"
3. "Top 50"
4. Select the desired track, if necessary.

### Albums

All stored albums, listed in order of their storage dates.

Symbol	Format
	Audio CD
	Compressed audio files

1. "CD/Multimedia"
2. "Music collection"
3. Select the desired album.

Depending on the album, the tracks or the subdirectories of the album are displayed.

The first track is played automatically, if possible.

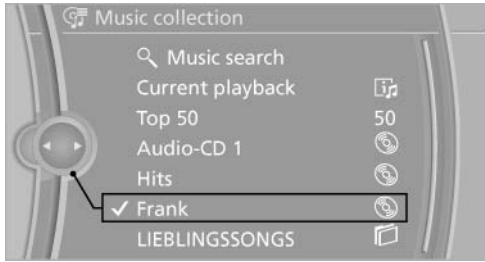

4. Change directories if needed to select tracks.

To go up a level in the directory: move the controller to the left.

## Random playback

All tracks of the selection are played back in random order.

1. "CD/Multimedia"
2. "Music collection"
3. Open "Options".
4. "Random"

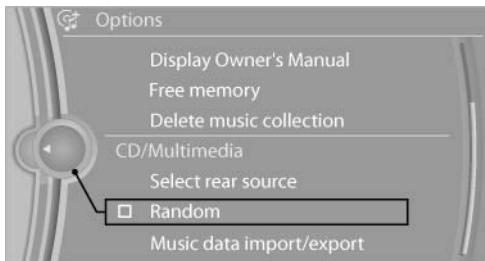

## Managing music

### Albums

#### Renaming an album\*

The name of the album, if available, is automatically entered when the album is stored. If the name is not available, it can be changed later if desired.

1. "CD/Multimedia"
2. "Music collection"

3. Highlight the desired album.
4. Open "Options".
5. "Rename album"



6. Select the letters individually.

#### Deleting an album

An album cannot be deleted while a track from that album is being played.

1. "CD/Multimedia"
2. "Music collection"
3. Highlight the desired album.
4. Open "Options".
5. "Delete album"

#### Deleting a track and directory

A track cannot be deleted while it is being played.

A directory cannot be deleted while a track from that directory is being played.

1. "CD/Multimedia"
2. "Music collection"
3. Highlight the directory or track.
4. Open "Options".
5. "Delete folder" or "Delete track"

#### Free memory capacity

Display the free memory capacity in the music collection.

1. "CD/Multimedia"
2. "Music collection"
3. Open "Options".
4. "Free memory"

## Music collection

### Backing up the music collection

The entire music collection can be stored on a USB device. Make sure there is enough free memory capacity on the USB device.

Depending on the number of tracks, backing up the music collection may take several hours. Therefore, it is best to perform the backup during a long trip.

1. Starting the engine.
2. Connect the USB device to the USB interface in the glove compartment.
3. "CD/Multimedia"
4. "Music collection"
5. Open "Options".
6. "Music data import/export"



7. "Backup music on USB"



### Storing the music collection in the vehicle

When storing from the USB device, the existing music collection in the vehicle is replaced.

1. "CD/Multimedia"
2. "Music collection"
3. Open "Options".

4. "Music data import/export"
5. "Restore music from USB"

### Deleting the music collection

1. "CD/Multimedia"
2. "Music collection"
3. Open "Options".
4. "Delete music collection"

## External devices

### At a glance

Symbol	Meaning
	AUX-IN port
	USB audio interface*
	Mobile phone audio interface*
	Bluetooth audio*
	Rear AUX-IN port* on the left
	Rear AUX-IN port* on the right

### AUX-IN port

#### At a glance

- ▷ For connecting audio devices, e.g., MP3 player. The sound is output on the vehicle loudspeakers.
- ▷ Recommendation: use medium tone and volume settings on the audio device. The tone depends on the quality of the audio files.

## Connecting

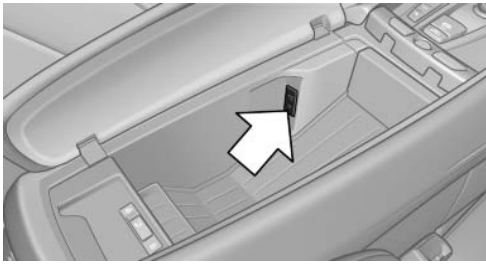

The AUX-IN port is in the center armrest.

Connect the headphones or line-out connector of the device to the jack plug.

## Playback

1. Connect the audio device, switch it on and select a track on the audio device.
2. "CD/Multimedia"
3. If necessary "External devices".
4.  "AUX front"

## Volume

The volume of the sound output is dependent on the audio device. If this volume differs markedly from the volume of the other audio sources, it is advisable to adjust the volumes.

## Adjusting the volume

1. "CD/Multimedia"
2. If necessary "External devices".
3.  "AUX front"
4. "Volume"

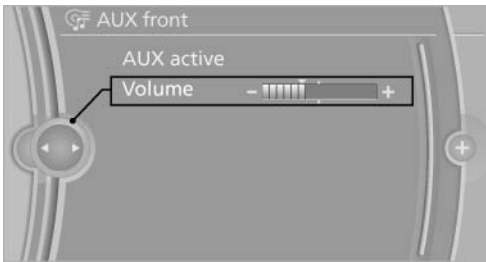

5. Turn the controller until the desired volume is set and press the controller.

## USB audio interface\*/mobile phone audio interface\*

### At a glance

It is possible to connect external audio devices. They can be operated via iDrive. The sound is output on the vehicle loudspeakers.

### Connectors for external devices

- ▷ Connection via USB audio interface: Apple iPod/iPhone, USB devices, e.g., MP3 players, USB flash drives, or mobile phones that are supported by the USB audio interface.
- ▷ Connection via snap-in adapter when equipped with extended connectivity of the music player in the mobile phone: Apple iPhone or mobile phones.

Due to the large number of different audio devices available on the market, it cannot be ensured that every audio device/mobile phone is operable on the vehicle.

Ask your service center about suitable audio devices/mobile phones.

### Audio files

Standard audio files can be played back:

- ▷ MP3.
- ▷ WMA.
- ▷ WAV (PCM).
- ▷ AAC\*, M4A\*.
- ▷ Playback lists: M3U, WPL, PLS.

## Connection of Apple iPod/iPhone via USB audio interface

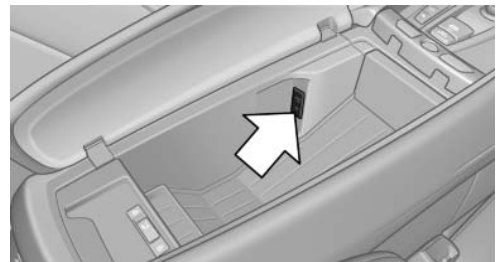

The USB audio interface is in the center armrest.

Connect using a flexible adapter cable.



Connect the Apple iPod/iPhone to the USB interface.

The Apple iPod/iPhone menu structure is supported by the USB audio interface.

### Connection of a USB device via the USB audio interface

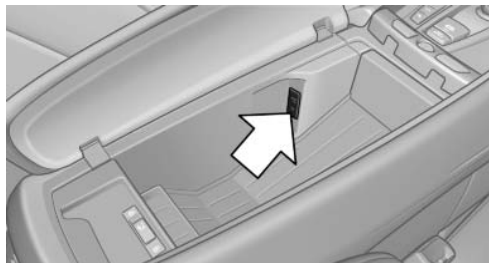

The USB audio interface is in the center armrest. Connect using a flexible adapter cable to protect the USB audio interface and the USB device against physical damage.



Connect the USB device to the USB interface.

### After connecting for the first time

Information on all music tracks, e.g. artist or type of music, as well as playback lists are transmitted into the vehicle. This may take some time, depending on the USB device and the number of tracks.

During transmission, the tracks can be called up via the file directory.



### Number of tracks

Information from up to four USB devices or for approx. 36,000 tracks can be stored in the vehicle. If a fifth device is connected or if more than 36,000 tracks are stored, information on existing music tracks may be deleted.

### Copy protection

Music tracks with integrated Digital Rights Management (DRM) cannot be played.

### Playback

1. "CD/Multimedia"
2. "External devices"
3. Select the  or  symbol.



The playback starts with the first track.

On the split screen\*, the CD cover for the music track might be displayed after a few seconds.



### Track search

Selection is possible via:

- ▷ Playback lists.
- ▷ Information: type of music, artist, and, if available, composer, album, track.
- ▷ In addition, for USB devices: file directory and, if available, composer.

Tracks are displayed if they have been saved in the Latin alphabet.

### Starting the track search

1. "CD/Multimedia"
2. "External devices"
3. Select the  or  symbol.
4.  "Search"
5. Select the desired category, e.g., "Genre" or "Artist".

All entries are displayed in a list.

- ▷ Open "A-Z search" and input the desired entry. When a letter is entered, the results are filtered using this letter as the first letter. If multiple letters are entered,

all results that contain that sequence are displayed.

- ▶ Select the desired entry from the list.

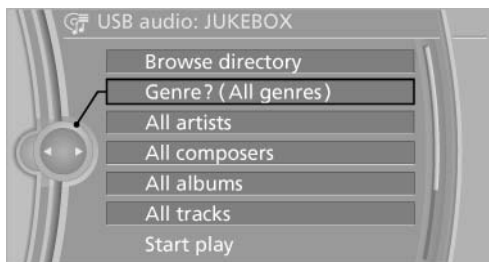

6. Select other categories if you wish.

Not all categories need to be selected. For example, if all of the tracks by a certain artist are to be displayed, call up that artist only. All of the tracks by that artist are then displayed.

7. "Start play"

### Restarting a track search

"New search"

### Playback lists

Calling up playback lists.

1. "CD/Multimedia"
2. "External devices"
3. Select the or symbol.
4. "Playlists"

### Current playback

List of tracks currently being played.

1. "CD/Multimedia"
2. "External devices"
3. Select the or symbol.
4. "Current playback"

### Random playback

The current list of tracks is played back in random order.

1. "CD/Multimedia"
2. "External devices"

3. Open "Options".
4. "Random"

### Fast forward/reverse

Press and hold the button.

### Video playback\*

#### At a glance

Video playback via snap-in adapter possible. They can be operated via iDrive. The sound is output on the vehicle loudspeakers.

#### Playback

The video image is displayed on the front Control Display up to a speed of approx. 2 mph/3 km/h; in some countries, it is only displayed if the parking brake is set or if the automatic transmission is in position P.

1. "CD/Multimedia"
2. "External devices"
3. Select the symbol.
4. "Video"
5. Select the directory if necessary.  
To change to a higher level directory: move the controller to the left.
6. Select the desired video file to begin playback.

#### Video menu

Symbol	Function
	Next video file
	Previous video file
	Double-click on an icon to play back previous video file.

#### Notes

Do not expose the audio device to extreme environmental conditions, such as very high temperatures; refer to the audio device operating instructions.

Depending on the configuration of the audio files, e.g., bit rates greater than 256 kbit/s, the files may not play back correctly in each case.

### Information on connection

- ▶ The connected audio device is supplied with a max. power of 500 mA if supported by the device. Therefore, do not additionally connect the device to a socket in the vehicle; otherwise, playback may be compromised.
- ▶ Do not use force when plugging the connector into the USB interface.
- ▶ Do not connect devices such as fans or lamps to the USB audio interface.
- ▶ Do not connect USB hard drives.
- ▶ Do not use the USB audio interface to re-charge external devices.

### Bluetooth audio\*

#### At a glance

- ▶ Music files on external devices such as audio devices or mobile phones can be played back via Bluetooth.  
Use of a mobile phone as an audio source, refer to page 211.
- ▶ The sound is output on the vehicle loudspeakers.
- ▶ The volume of the sound output is dependent on the device. If necessary, adjust the volume on the device.
- ▶ Up to four external devices can be paired with the vehicle.

#### Requirements

- ▶ The device is suitable. Information under [www.bmwusa.com/bluetooth](http://www.bmwusa.com/bluetooth).
- ▶ The device is ready for operation.
- ▶ The ignition is switched on.
- ▶ Bluetooth is activated on the vehicle, refer to page 211, and on the device.
- ▶ Bluetooth presettings must be made on the device, such as for a connection without

confirmation or visibility; refer to the device operating instructions.

- ▶ A number with at least four and a maximum of 16 digits is defined as the Bluetooth passkey. It is only required once for pairing.

### Pairing and connecting



#### Pairing a device

To avoid becoming distracted and posing an unnecessary hazard both to your own vehicle's occupants and to other road users, only pair the device while the vehicle is stationary. ◀

1. "CD/Multimedia"
2. "Bluetooth® (audio)"
3. If necessary, "Bluetooth® audio".
4. "Add new phone"

The Bluetooth name of the vehicle is displayed.



5. Perform additional steps on the device, refer to the device operating instructions: for instance, search for or connect the Bluetooth device or a new device.

The Bluetooth name of the vehicle appears on the device display.

6. Select the Bluetooth name of the vehicle on the device display.

Prompt via iDrive or the device to enter the same Bluetooth passkey.



7. Enter the passkey and confirm.

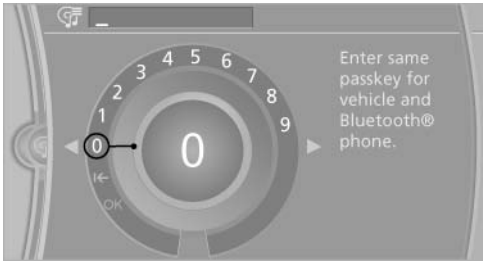

8. Select the desired functions with which the device is to be connected, for instance "Audio".
9. "OK"



If pairing was successful, the device is displayed as connected.

White symbol : the device is active as an audio source.

If pairing was unsuccessful: What to do if..., refer to page 198.

### Connecting a specific device

A device that has already been paired can be connected as an active audio source.

Connecting is not possible when data is exchanged via a mobile phone connected via Bluetooth.

### Requirements

If necessary, activate the audio connection of the desired device from the list of paired devices.

1. "CD/Multimedia"
2. "Bluetooth® (audio)"
3. If necessary, "Bluetooth® audio".

4. Select the desired device from the list of paired devices.
5. Open "Options".
6. "Configure phone"
7. "Audio"
8. "OK"

### Connecting the device

1. "CD/Multimedia"
2. "Bluetooth® (audio)"
3. If necessary, "Bluetooth® audio".
4. Select the desired device from the list of paired devices.



White symbol : the device is active as an audio source.

### Playback

#### General information

- ▶ The display of music track information depends on the device.
- ▶ Operation can take place on the device or iDrive.
- ▶ Playback is interrupted when data is exchanged via a mobile phone connected via Bluetooth.

#### Starting playback

1. Connect the device.
2. "CD/Multimedia"
3. "External devices"

4. Select the symbol.

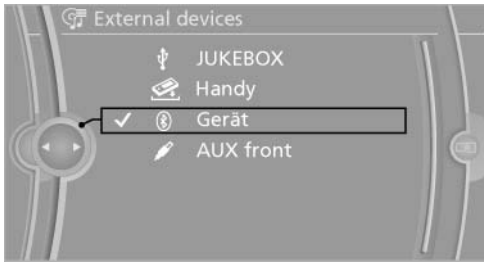

5. Select the desired track from the list, if necessary.

### Playback menu\*

Depending on the particular device, some of the functions may not be available.

Symbol	Function
▶	Next track Fast forward: press and hold the symbol.
◀	Previous music track Reverse: press and hold the symbol.

### Disconnecting the audio connection

1. "CD/Multimedia"
2. "Bluetooth® (audio)"
3. Highlight the desired device.
4. Open "Options".
5. "Configure phone"

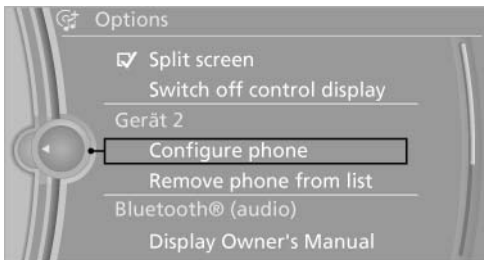

6. "Audio"
7. "OK"

### Unpairing a device

1. "CD/Multimedia"
2. "Bluetooth® (audio)"
3. If necessary, "Bluetooth® audio".
4. Highlight the device that is to be unpaired.
5. Open "Options".
6. "Remove phone from list"

### What to do if...

Information on suitable devices can be found at [www.bmwusa.com/bluetooth](http://www.bmwusa.com/bluetooth).

Suitable mobile phones, refer to page 210.

The device is not supported by the vehicle.

- ▶ Perform a software update\*, refer to page 199, if needed.

The device could not be paired or connected.

- ▶ Do the Bluetooth passkeys on the device and the vehicle match? Enter the same passkey on the device and via iDrive.
- ▶ Did it take longer than 30 seconds to enter the passkey? Repeat the pairing procedure.
- ▶ Are too many Bluetooth devices connected to the device or vehicle? Delete connections with other devices if necessary.
- ▶ Is the mobile phone in power-save mode or does it have only a limited remaining battery life? Charge the mobile phone in the snap-in adapter or via the charging cable.
- ▶ Depending on the mobile phone, it is possible that only one device can be connected to the vehicle. Unpair the connected device from the vehicle and pair and connect only one device.
- ▶ The device no longer reacts? Switch the device off and on again.
- ▶ Repeat the pairing procedure.

Music cannot be played back.

- ▶ Start the program for playing back music data on the device and select a track on the device if necessary.
- ▶ Switch the radio off and on again.

Music files can only be played back softly.

- ▷ Adjust the volume settings on the device. Playback is disturbed when buttons are pressed or by other messages on the device.
- ▷ Switch off the button tones and other signal tones on the device.

Playback is interrupted by a telephone call or traffic bulletin and is not resumed automatically.

- ▷ Switch the radio off and on again. Playback is not possible if the mobile phone is connected both via Bluetooth Audio and via the extended connectivity of the music player in the mobile phone\*.
- ▷ Disconnect one of the two connections; for example, disconnect the audio connection, refer to page 198, and restart playback.

If all points in this list have been checked and the required function is still not available, please contact the hotline or service center.

## Software Update\*

The vehicle supports various external devices depending on the current software version. With a software update, the vehicle can support new cell phones\* or new external devices\*.

The updating of the software is done via:

- ▷ USB\*. Updates and related current information is available at [www.bmw.com/update](http://www.bmw.com/update).
- ▷ TeleService\*. Existing software can be updated directly via the vehicle.

## Displaying the current version

The currently installed software is displayed.

1. "Settings"
2. "Software update"
3. "Show current version"

Select Desired version\* to display Additional information\*.

## Updating software via USB\*

The software may only be updated when the vehicle is stationary.

1. Store the file for the software-update in the main director of a USB flash drive.
2. Insert the USB flash drive into the USB interface of the USB audio interface in the center armrest. An update via the USB interface in the glove compartment is not possible.
3. "Settings"
4. "Software update"
5. "Update software"

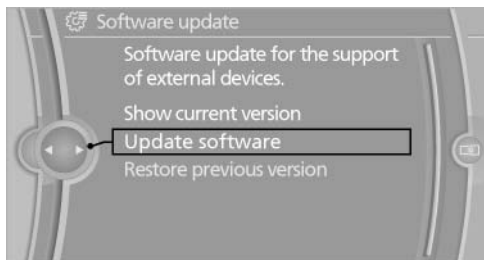

6. If necessary. "USB".
7. "Start update"
8. "OK"

All listed software updates are installed.

## Updating software via TeleService\*

The software may only be updated when the vehicle is stationary.

1. Switch on the ignition.
2. "Settings"
3. "Software update"
4. "Update software"
5. If necessary "TeleService".
6. If necessary, "Start update".
7. "Start update"
8. "OK"

All listed software updates are installed.

To interrupt updating: "Cancel".

## Restoring the previous version

If it should become necessary, the software version prior to the last software update can be restored.

The previous version may only be restored when the vehicle is stationary.

1. "Settings"
2. "Software update"
3. "Restore previous version"
4. "OK" Double-click.

All listed software updates are removed.

### Note

While the software is being updated or a previous version is being restored BMW Assist\*, Office functions\* and the connected devices are temporarily unavailable. Wait several minutes for the functions to become available again.

# Rear entertainment\*

## Controls

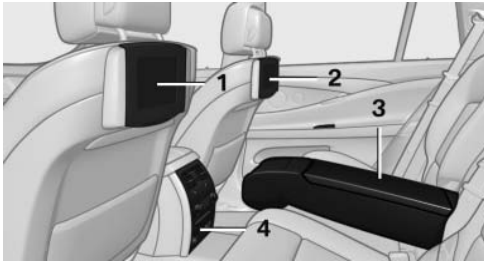

- 1 Screen, left
- 2 Screen, right
- 3 Center armrest, remote control
- 4 CD/DVD player

## Rear CD/DVD player

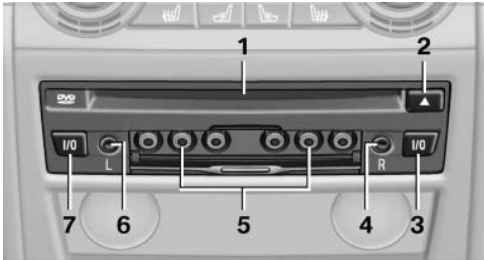

- 1 CD/DVD slot
- 2 Eject CD/DVD
- 3 On/off, right
- 4 Headphone connection, right
- 5 RCA sockets
- 6 Headphone connection, left
- 7 On/off, left

## Switching the system on/off

I/O

Press the left or right side of the button on the CD/DVD player in the rear for the respective page.

Rear entertainment and screens are switched on/off.

After switching off the ignition, the system must be switched on again.

## Screens

### Adjusting



Danger of burns when screen is folded out. Do not reach behind the screen; otherwise, there is the danger of getting burned. The back of the screen can become very hot. ◀

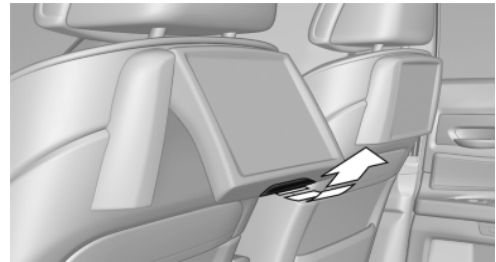

- ▷ To fold out: pull at the bottom edge.
- ▷ To fold in: press against the bottom edge.

### Notes

- ▷ Do not cover lower screen edge, since this is where the sensors and the infrared interface are installed.
- ▷ When loading the rear seats and adjusting the backrest of the front seat, fold in the screens.
- ▷ When using the through-loading system, fold the screens down.
- ▷ When cleaning the screen, follow the care instructions, refer to page 271.

## Remote control

### In the center armrest in the rear



Storage is possible in a vertical or horizontal position in the center armrest.

### Menu navigation

Press the button Function



Operating concept as for the front controller.

Turn the wheel: highlight a menu item.

Press the center knob: confirm the selection.

Pressing arrow keys corresponds to moving controller: switching between panels.



Open the main menu.



Displays the previous menu.



Opens the "Options" menu.



Changes the station, track or chapter.

Press and hold the button: fast forward/reverse.

Press the button Function



Adjusts the volume.



Switches the volume adjustment to the left/right.

With Professional rear entertainment\*: Toggles between the screens.

The transmission time of the remote control is limited by law. To execute a function again, press or turn the required button again.

### Replacing the batteries



No rechargeable batteries

Do not use rechargeable batteries, as damage may result from the substances in the batteries. ◀

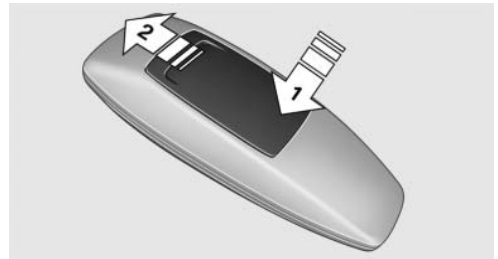

1. Remove the cover. Press on the cover, arrow 1, and push forward, arrow 2.
2. Insert batteries of the same type.
3. Close the cover.



Take the used battery to a recycling center or to your service center.

### Controls

Almost all functions can be operated in the same manner as they are in the front. Special features of operating the system in the rear are described here.

## Audio/video playback

### Audio

Audio can be played back via rear entertainment from any source in the vehicle.

Operation is the same as for the front audio playback, refer to page [181](#).

### Video

Video can be played back in the rear from the following sources:

- ▷ DVD changer\*.
- ▷ Rear CD/DVD player.
- ▷ External device in rear.

If a video image is being played back in the rear, the rear CD/DVD player cannot be selected in the front.

Operation is the same as for the front video playback, refer to page [183](#).

### Radio

When the same radio source is selected in the front and rear (e.g., FM/AM), the same radio station is played.

Operation is the same as for the front radio, refer to page [174](#).

### CD/multimedia

#### CD/DVD

When the same audio source (front CD/DVD player, rear CD/DVD player, DVD changer) is selected in the front and rear, the same material is played.

Operation is the same as for the front CD/DVD, refer to page [181](#).

Notes on CDs/DVDs, refer to page [187](#).

#### Music collection\*

Music can only be stored and data can only be exported and imported via the front CD/DVD player or the USB interface in the glove compartment.

When music collections are selected in the front and rear, they are played back separately.

Operation is the same as for the front music collection, refer to page [188](#).

### Tone

Only treble and bass can be set in the rear. The settings are made separately for the left and right headphones.

Operation is the same as for the front tone, refer to page [172](#).

### Contacts\*

Operation is the same as for the front contacts.

### Navigation\*

Route planning can be performed separately on the left and right sides in the rear. Destination guidance can only be started from the front.

Operation is the same as for the front navigation, refer to page [154](#).

### Suggesting a destination

A destination or trip can be sent to the front as a suggestion. The suggestion can be adopted, stored, or declined in the front. This function is not available with the following setting: "Driver control".

1. Enter the destination.
2. "Suggest destination"

### BMW Assist\*

Operation is the same as for BMW Assist in the front, refer to page [232](#).

### Adjusting

The following settings are available:

- ▷ "Rear displays"
- ▷ "Language/Units": language can be set globally for all screens.
- ▷ "Tone"
- ▷ If necessary. "Climate".

## Vehicle information\*

Computer content can be displayed. Operation is only possible in the front.

## Options menu

The split screen is not available and there is no Integrated Owner's Manual.

Operation is the same as for the front menu options, refer to page 21.

## Enabling

### Enabling operation in the rear

Only possible via the iDrive in the front.

1. "Settings"
2. "Allow rear control"
3. Select the desired priority.

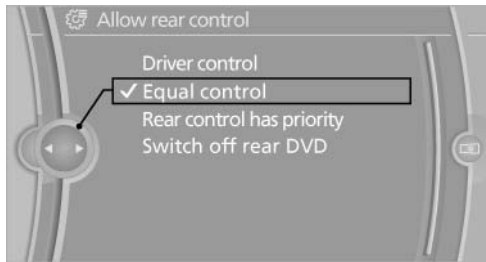

## Priority options

### The driver has priority

- ▶ The source selected via iDrive in the front is output on the vehicle loudspeakers and can be selected but not operated from the rear. Other audio or video sources can be operated.
- ▶ Sound can only be output in the rear via headphones.
- ▶ The source that is to be displayed in the rear can be set via the iDrive in the front.

To set the source in the rear via the iDrive in the front:

1. "CD/Multimedia" or "Radio"
2. Open "Options".
3. "Select rear source"
4. Select the desired audio or video source.

### Same priority

- ▶ All audio and video sources can be operated via the iDrive in the front and rear.
- ▶ Sound is output in the rear via headphones: the source selected via the iDrive in the front is output on the vehicle loudspeakers.
- ▶ Sound is output via loudspeakers: the source selected last via the iDrive in the front or rear is output via the vehicle loudspeakers.

### The rear has priority

- ▶ When the source selected in the rear is played on headphones, it can be selected but not operated via iDrive in the front. Other audio or video sources can be operated.
- ▶ Sound is output in the rear via headphones: the source selected via the iDrive in the front is output on the vehicle loudspeakers.
- ▶ Sound is output via loudspeakers: the source selected in the rear is output on the vehicle loudspeakers. Audio or video sources cannot be selected via the iDrive in the front.

### Switching off the rear DVD

- ▶ Rear entertainment is switched off.
- ▶ To switch rear entertainment back on: select a different priority via the iDrive in the front and switch on the system, refer to page 201.



# Headphones, vehicle loudspeakers

## Connecting the headphones

### Normal headphones

Connect via the jack 1/8"/3.5 mm, refer to page 201, on the rear CD/DVD player.

### Infrared headphones

Connection via the infrared interface on the lower edge of the screen.

Fitting infrared headphones and information on which headphones are supported can be obtained from your service center.

When using infrared headphones, ensure that the connection between the headphones and the infrared interface is not disrupted:

- ▷ Do not place an obstacle between the interface and headphones.
- ▷ Do not cover the interface.
- ▷ Do not scratch the interface.

Fold up display screens for interference-free reception.

Unfavorable light conditions such as bright ambient light can impair reception.

### Sound output on the headphones or vehicle loudspeakers

Operation is only possible in the rear.

1. Open "Options".
2. "Headphones" or "Loudspeakers"

With the following setting, sound output in the rear is not possible via the vehicle speakers: "Driver control".

## External devices

### General information



External audio and video devices and digital cameras can be connected to cinch sockets, refer to page 201, on the CD/DVD player. Operation takes place on the external device.

Due to the large number of different audio and video devices available on the market, it cannot be ensured that every audio and video device will be displayed correctly on the screen.

### Connecting an external device

1. Fold down the cover in front of the cinch sockets on the CD/DVD player.
2. Connect the external device to the RCA sockets.
  - ▷ Video: yellow socket.
  - ▷ Audio: white and red socket.

### Starting playback



1. "CD/Multimedia"
2. "External devices"
3. Select the  or  symbol.

### Volume

The volume of the sound output is dependent on the audio device. If this volume differs markedly from the volume of the other audio sources, it is advisable to adjust the volumes.

### Adjusting the volume

The volume can only be adjusted if no external video device is connected.

1. "CD/Multimedia"
2. "External devices"
3. Select the  or  symbol.
4. "Volume"

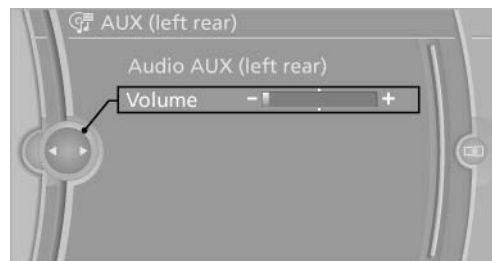

5. Turn the controller until the desired volume is set and press the controller.

## What to do if...

Only a black screen is visible.

- ▷ Switch on the system.

There are no options available on the screen.

- ▷ Replace remote control batteries.
- ▷ With Professional rear seat entertainment toggle between screens if necessary.

Radio stations or TV channels are grayed out and cannot be selected.

- ▷ Function is limited due to the selected priority. Change priority.

The DVD does not play.

- ▷ Playback does not begin automatically. Start DVD manually, refer to page [183](#).

The volume of the rear vehicle speakers cannot be adjusted.

- ▷ Sound in the rear is output via the headphones. Change priority if necessary and output sound via vehicle speakers.





# Communication

All of the options available to you for mobile communication with family, friends, business partners, and service providers are described in this chapter.

# Telephone\*

## At a glance

### The concept

Mobile phones or other external devices such as audio players can be connected to the vehicle via Bluetooth.

After these devices are paired once, they are recognized automatically when the ignition is switched on as soon as they are inside the vehicle and can be operated via iDrive, the buttons on the steering wheel, and via voice activation\*.

Depending on their functionality, external devices can be used via the vehicle as a telephone or as an audio source.

The telephone functions are described in the following. Operating the audio functions, refer to page 196.

Up to four external devices can be paired.

Certain functions may need to be enabled by the mobile phone provider or service provider.



Using the mobile phone while driving

Make entries only when traffic and road conditions allow. Do not hold the mobile phone in your hand while you are driving; use the hands-free system instead. If you do not observe this precaution, you can endanger the vehicle occupants and other road users. ◀

### Snap-in adapter\*

The snap-in adapter is used to:

- ▷ Hold the mobile phone.
- ▷ Recharge the battery.
- ▷ Connect the mobile phone to an outside antenna of the vehicle.

This provides for better network reception and consistent sound quality.

### Approved mobile phones

Details on which mobile phones and external devices with a Bluetooth interface are supported by the mobile phone preparation pack-

age can be obtained at [www.bmwusa.com/bluetooth](http://www.bmwusa.com/bluetooth).

### Displaying the vehicle identification number and software part number

The vehicle identification number and software part number are needed to determine which mobile phones are supported by the mobile phone preparation package. The software version of the mobile phone may also be required.

1. "Telephone"
2. Open "Options".
3. "Bluetooth® info"
4. "Display system information"

These approved mobile phones with a certain software version, support the vehicle functions described below.

Malfunctions may occur with other mobile phones or software versions.

Do not operate a mobile phone that is connected to the vehicle on the mobile phone keypad, as this may lead to a malfunction.

A software update can be performed if necessary.

## Pairing/unpairing the mobile phone

### General information

The following functions are available:

- ▷ Use of a mobile phone as a telephone.
- ▷ Use of a mobile phone as an additional telephone.
- ▷ Use of a mobile phone as an audio source.
- ▷ Use of an audio device as an audio source, refer to page 196.

### Requirements

- ▷ The mobile phone is suitable.

- ▷ The mobile phone is ready for operation.
- ▷ Bluetooth is activated in the vehicle and on the mobile phone.
- ▷ Bluetooth presettings may need to be made on the mobile phone, e.g., for a connection without confirmation or visibility, refer to the mobile phone operating instructions.
- ▷ Deactivate Bluetooth audio if necessary.
- ▷ A number with at least four and a maximum of 16 digits was defined as the Bluetooth passkey. It is only required once for pairing.
- ▷ The ignition is switched on.

## Activating/deactivating Bluetooth

Bluetooth is not permitted everywhere. Comply with all safety guidelines and regulations.

1. "Telephone"
2. Open "Options".
3. "Bluetooth@"

## Additional functions

### General information

Activate the functions before pairing to be able to use them in the vehicle. Information on suitable mobile phones, refer to page 210, that support these functions.

### Additional telephone

A mobile phone can be used as an additional telephone.

The additional telephone can be used to accept incoming calls, refer to page 214. While a call is active on the additional telephone, incoming calls are displayed on the Control Display.

### Audio source

A mobile phone can be used as an audio source.

## Activating/deactivating the additional functions

1. "Telephone"
2. "Bluetooth@ (phone)"

3. Open "Options".
4. Select the desired additional function.
  - ▷ "Additional telephone"
  - ▷ "Office"
  - ▷ "Bluetooth@ audio"

## Pairing and connecting a device



### Pairing a device

To avoid becoming distracted and posing an unnecessary hazard both to your own vehicle's occupants and to other road users, only pair the device while the vehicle is stationary. ◀

Pair the vehicle entirely on the front or rear Control Display.

1. "Telephone"
2. "Bluetooth@ (phone)"
3. "Add new phone"

The Bluetooth name of the vehicle is displayed.

4. To perform additional steps on the mobile phone, refer to the mobile phone operating instructions: for instance, search for or connect the Bluetooth device or a new device.

The Bluetooth name of the vehicle appears on the mobile phone display.

5. Select the Bluetooth name of the vehicle on the mobile phone display.

Prompt via iDrive or the mobile phone to enter the same Bluetooth passkey.

6. Enter the passkey and confirm.

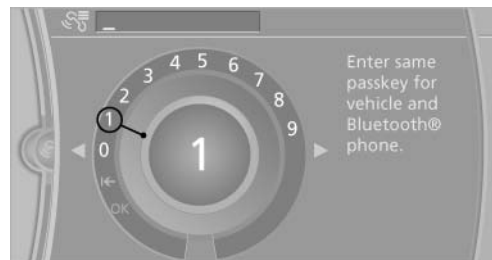



7. Select the functions for which the mobile phone is to be used.
8. "OK"

If the pairing was successful, the mobile phone appears at the top of the list of mobile phones. The functions supported by the mobile phone and audio device are displayed as symbols when paired.

White symbol: the function is active.

Gray symbol: the function is inactive.

Symbol	Function
	Telephone.
	Additional telephone.
	Audio source.

Four devices can be paired with the vehicle at once. Three devices can be connected with the vehicle at once.

If pairing was unsuccessful: What to do if..., refer to page 212.

### Following the initial pairing

- ▷ The mobile phone is detected/connected in the vehicle within a short period of time when the engine is running or the ignition is switched on.
- ▷ The phone book entries of the telephone stored on the SIM card\* or mobile phone are transmitted to the vehicle after detection, depending on the mobile phone.
- ▷ Four devices can be paired.
- ▷ Specific settings may be necessary in some mobile phones, e.g., authorization or a secure connection; refer to the mobile phone operating instructions.

### Connecting a specific device

If more than one device is detected by the vehicle, the device at the top of the list is connected. A different device can be connected by selecting it.

1. "Telephone"
2. "Bluetooth® (phone)"
3. Select the device that is to be connected.

The functions that were assigned to the device before unpairing are assigned to the device when it is reconnected. If the device is already connected, these functions are deactivated.

### Configuring the devices

Additional functions can be activated or deactivated for paired and connected devices.

1. "Telephone"
2. "Bluetooth® (phone)"
3. Highlight the device to be configured.
4. Open "Options".
5. "Configure phone"
6. At least one function must be selected.
  - ▷ "Telephone"
  - ▷ "Additional telephone"
  - ▷ "Audio"
7. "OK"

If a function is assigned to a device, the function will be deactivated where appropriate for a device that is already connected and the device will be unpaired.

### Swapping the telephone and additional telephone

The function of the telephone and additional telephone can be swapped automatically.

1. "Telephone"
2. "Bluetooth® (phone)"
3. "Swap phone/addit. phone"

### Unpairing a device

1. "Telephone"
2. "Bluetooth® (phone)"
3. Highlight the device that is to be unpaired.
4. Open "Options".
5. "Remove phone from list"

### What to do if...

Information on suitable mobile phones, refer to page 210.



The mobile phone could not be paired or connected.

- ▷ Is Bluetooth activated in the vehicle and on the mobile phone? Activate Bluetooth in the vehicle and on the mobile phone.
- ▷ Do the Bluetooth passkeys on the mobile phone and the vehicle match? Enter the same passkey on the mobile phone and via iDrive.
- ▷ Did it take longer than 30 seconds to enter the passkey? Repeat the pairing procedure.
- ▷ Are too many Bluetooth devices connected to the mobile phone or vehicle? Delete connections with other devices if necessary.
- ▷ Is the audio connection activated? Deactivate the audio connection.
- ▷ Is the mobile phone in power-save mode or does it have only a limited remaining battery life? Charge the mobile phone in the snap-in adapter\* or via the charging cable.
- ▷ Depending on the mobile phone, it is possible that only one device can be connected to the vehicle. Unpair the connected device from the vehicle and pair and connect only one device.
- ▷ The mobile phone no longer reacts? Switch the mobile phone off and on again. Repeat the pairing procedure.

The telephone functions are not available.

- ▷ Is the mobile phone paired as an additional telephone and is the additional telephone function deactivated? Activate the function.
- ▷ Is an outgoing call not possible? Connect the mobile phone as a telephone.

No or not all phone book entries are displayed, or they are incomplete.

- ▷ Transmission of the phone book entries is not yet complete.
- ▷ It is possible that only the phone book entries of the mobile phone or the SIM card\* are transmitted.
- ▷ It may not be possible to display phone book entries with special characters.

- ▷ The number of phone book entries being stored is too high.
- ▷ Is the data volume of the contact too large, e.g., due to stored information such as notes? Reduce the data volume of the contact.
- ▷ Is the mobile phone connected as an audio source or additional telephone? The mobile phone must be connected as a telephone.

The phone connection quality is poor.

- ▷ The strength of the Bluetooth signal on the mobile phone can be adjusted, depending on the mobile phone.
- ▷ Insert the mobile phone into the snap-in adapter\* or place it in the area of the center console.
- ▷ Adjust the volume of the microphone and loudspeakers separately.

If all points in this list have been checked and the required function is still not available, please contact the hotline or service center.

## Controls

### Adjusting the volume

Turn the knob until the desired volume is selected. The setting is stored for the remote control currently in use.

The vehicle automatically adjusts the volume of the microphone on the telephone and the volume of the called party. Depending on the mobile phone, the volumes may need to be adjusted. The settings can only be created during a call and must be adjusted separately for each telephone. The settings are deleted when the telephone is unpaired.

1. "Settings"
2. "Tone"
3. "Volume settings"
4. Select the desired setting: "Microphone" or "Loudspeak."
5. To adjust: turn the controller.
6. To store: press the controller.

## Incoming call

### Receiving calls

If the number of the caller is stored in the phone book and is transmitted by the network, the name of the contact is displayed. Otherwise, only the phone number is displayed.

If more than one phone number is assigned to a contact, only the name of the contact is displayed.

For calls on the additional telephone, the number is only displayed if it is transmitted by the network.

An incoming call to the additional telephone is automatically rejected if there is an active call on the other telephone.

### Accepting a call

#### Via iDrive

 "Accept"

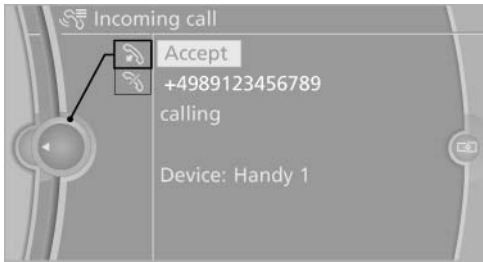

#### Via the button on the steering wheel

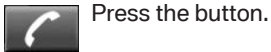

#### Via the instrument cluster\*

"Accept"

### Rejecting a call

#### Via iDrive

 "Reject"

#### Via the instrument cluster\*

"Reject"

## Ending a call

### Via iDrive

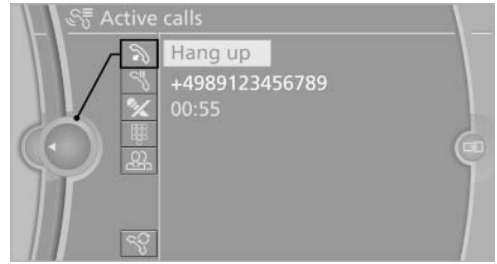

 "End call"

### Via the button on the steering wheel

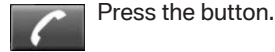

### Via the instrument cluster\*

"End call"

## Entering a phone number

### Dialing a number

1. "Telephone"
2. "Dial number"
3. Select the digits individually.
4.  Select the symbol.



The phone number can also be entered by voice.

## Calls with multiple participants

### General information

You can switch between calls or connect two calls to a single conference call. These functions

must be supported by the mobile phone and service provider.

## Accepting a call while speaking to another party

This function might have to be activated by the service provider and the mobile phone must be adjusted accordingly.

If a second call comes in during an ongoing call, a call waiting signal is sounded where appropriate.

 "Accept"

The call is accepted and the existing call is put on hold.

## Establishing a second call

Establish an additional call during an active call.

1. "Telephone"
2. "Active calls"
3.  "Hold"

The existing call is put on hold.

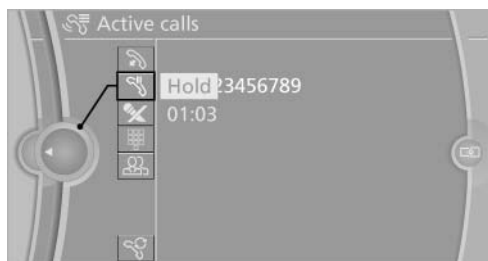

4. Dial the new phone number or select it from a list.

 "Return"

The call on hold is resumed.

## Switching between two calls, hold call

The active call is displayed in color.

The call on hold is displayed in gray.

 "Swap calls"

The call on hold is resumed.

## Establishing a conference call

Two calls can be connected to a single telephone conference call.

1. Establish two calls.
2.  "Conference call"

When terminating a conference call, both calls are ended. If one call is terminated by another party, the other call can be continued.

## Switching the microphone to mute

When a call is active, the microphone can be muted.

1. "Telephone"
2. "Active calls"
3.  "Microphone mute"

A microphone that has been switched to mute is automatically reactivated:

- ▷ When a new connection is established.
- ▷ When switching between call parties.

## DTMF suffix dialing

DTMF suffix dialing can be used for gaining access to network services or for controlling devices, e.g., to make a remote inquiry of an answering machine. The DTMF code is needed for this purpose.

1. "Telephone"
2. Select the contact from a list or "Dial number".
3.  "Keypad dialing"
4. Enter the DTMF code via iDrive.

## Phone book

### Displays

The phone book accesses the contacts and shows all contacts for which a phone number has been stored. The entries can be selected to make a call.

1. "Telephone"
2. "Phone book"

A symbol indicates the storage location of the contacts.

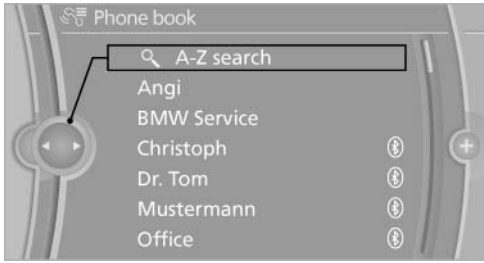

## Calling a contact

Symbol	Meaning
	Contact with one stored phone number.
	Contact with more than one stored phone number.
	Call not possible; mobile phone without reception or network, or Service Request* is active.

For contacts with one stored phone number: select the required contact. The connection is being established.

For contacts with more than one stored phone number: select the required contact and the phone number. The connection is being established.

## Editing a contact

Changing the entries in "Contacts". When a contact is changed, the changes are not stored on the mobile phone. A copy of the entry is stored in the vehicle.

1. Highlight the contact.
2. Open "Options".
3. "Edit entry"

The contact can be edited.

## Redialing

### General information

The list of dialed numbers in the mobile phone is transmitted to the vehicle depending on the mobile phone. The 20 phone numbers dialed last are displayed. The sorting order of the phone numbers depends on the particular mobile phone.

### Dialing the number via the instrument cluster

This is possible when there is no active call.

1. Press the button on the steering wheel.
2. Select the desired phone number.

The connection is established.

### Dialing a number via iDrive

1. "Telephone"
2. "Redial"
3. Select the desired entry and the phone number if necessary.

The connection is established.

### Saving an entry in the contacts

1. Highlight the entry.
2. Open "Options".
3. "Store as new contact" or "Add to existing contact"
4. Select "New phone number" or contact.
5. Select the type of number: "Home", "Business", "Mobile" or "Other"
6. Complete the entries if necessary.
7. If necessary, "Store contact in vehicle".

## Received calls

### Displaying calls

The 20 calls that were last received are displayed.

1. "Telephone"

## 2. "Received calls"

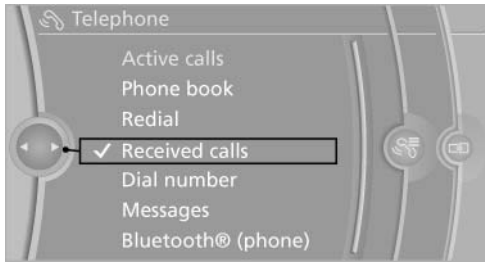

### Calling a number from the list

Selecting an entry.

The connection is established.

### Saving an entry in the contacts

1. Highlight the entry.
2. Open "Options".
3. "Store as new contact" or "Add to existing contact"
4. Select  "New phone number" or contact.
5. Select the type of number: "Home", "Business", "Mobile" or "Other"
6. Complete the entries if necessary.
7. If necessary, "Store contact in vehicle".

### Hands-free system

#### General information

Calls that are being made on the hands-free system can be continued on the mobile phone and vice versa.

#### From the mobile phone to the hands-free system

Calls that were begun outside of the Bluetooth range of the vehicle can be continued on the hands-free system with the ignition switched on.

Depending on the mobile phone, the system automatically switches to the hands-free system.

If the system does not switch over automatically, follow the instructions on the mobile phone display;

refer also to the mobile phone operating instructions.

### From the hands-free system to the mobile phone

Calls that are made on the hands-free system can in some cases be continued on the mobile phone; this depends on the mobile phone.

Follow the instructions on the mobile phone display; refer also to the mobile phone operating instructions.

### Voice operation\*

Vehicles equipped with the voice activation system: operation, refer to page 25.

Vehicles not equipped with the voice activation system: depending on the equipment, the mobile phone can be voice operated as described below.

The list of short commands in the operating manual does not apply to this type of voice operation.

#### The concept

- ▶ The mobile phone can be operated without taking your hands from the steering wheel.
- ▶ In many cases, the entries are accompanied by announcements or questions.
- ▶ ...« Verbal instructions for voice operation.

#### Using voice activation

#### Activating the voice activation system

1.  Briefly press the button on the steering wheel.
2. Say the command.

#### Terminating the voice activation system

1.  Briefly press the button on the steering wheel or .Cancel.

## Possible commands

### Having possible commands read aloud

Press the button. ›Help‹. Possible commands are announced.

The digits from zero to nine are recognized. The digits can be spoken separately or combined in a sequence to accelerate the entry.

### Using alternative commands

The system often recognizes a number of different commands to run a function; for instance:

›Dial name‹ or ›Name‹

### Example: dialing a phone number

-  Briefly press the button on the steering wheel.
- ›Dial number‹  
The system says: »Please say the number«
- E.g., ›123 456 790‹  
The system says: »123 456 790. Continue?«
- ›Dial‹  
The system says: »Dialing number«

## Calling

### Dialing a phone number

- ›Dial number‹
- Say the phone number.
- ›Dial‹

### Correcting the phone number

The sequence of digits can be deleted after the system has repeated the digits.

›Correct number‹

The command can be repeated as often as necessary.

### Deleting a phone number

›Delete‹

All digits entered up to that point are deleted.

## Redialing

›Redial‹

## Voice phone book\*

Depending on how your vehicle is equipped, it may be necessary to create your own voice phone book.

The entries must be entered using voice activation and are separate from the memory in the mobile phone. Up to 50 entries can be set up.

### Saving an entry

- ›Save name‹
- Say the name. Do not exceed the speaking duration of approx. 2 seconds.
- Say the phone number after being prompted to do so by the system.
- ›Save‹

### Deleting an entry

- ›Delete name‹
- Say the name after being prompted to do so.
- Confirm the query with ›Yes‹.

### Deleting all entries

- ›Delete phonebook‹

The dialog for deleting the phone book is opened.

- Confirm the query with ›Yes‹.
- Confirm the query again with ›Yes‹.

### Reading and selecting entries

- ›Read phonebook‹

The dialog for reading the phone book is opened.

- Say ›Dial number‹ when the desired entry is read.

### Selecting an entry

- ›Dial name‹
- Say the name after being prompted to do so.
- Confirm the query with ›Yes‹.

## Adjusting the volume

Turn the knob during an announcement.

- ▷ The volume remains constant even if the volume of other audio sources is changed.
- ▷ The volume is stored for the remote control currently in use.

## Notes

Do not use the voice operation to initiate an Emergency Request. In stressful situations, the voice and vocal pitch can change. This can unnecessarily delay the establishment of a telephone connection.

Instead, use the SOS button\*, refer to page 264, in the vicinity of the interior mirror.

## Environmental conditions

- ▷ Say the commands, numbers, and letters smoothly and with normal volume, emphasis, and speed.
- ▷ Always say commands in the language of the system. The language for the mobile phone voice operation is preset and cannot be changed in the Control Display.
- ▷ Keep the doors, windows, and glass sun-roof\* closed to prevent noise interference.
- ▷ Avoid making other noise in the vehicle while speaking.

## Snap-in adapter\*

### Installation position

In the center armrest.

## Inserting the snap-in adapter

1. Press the button and remove the cover.

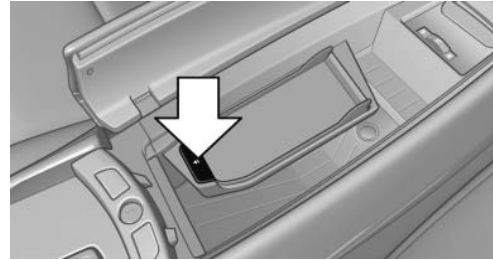

2. Insert the snap-in adapter at the front, arrow 1, and press down, arrow 2, until it engages.



## Inserting the mobile phone

1. Depending on the mobile phone, remove the protective cap from the antenna connector of the mobile phone.
2. Slide the mobile phone with the buttons facing up in the direction of the electrical connections, arrow 1, and push downward, arrow 2 until it engages.

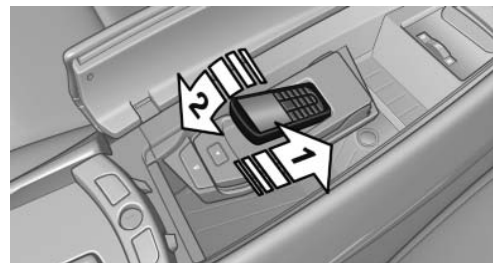

## Removing the mobile phone

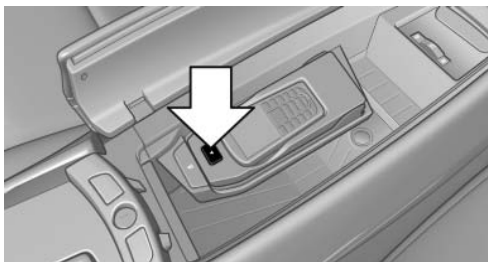

Press the button and remove the mobile phone.



## At a glance

### General information

Contacts, appointments, tasks, notes, text messages, and e-mails from the mobile phone can be displayed on the Control Display if the mobile phone provides compatible support of these functions and the necessary Bluetooth standards.

Information about which mobile phones support the Office functions can be found at [www.bmwusa.com/bluetooth](http://www.bmwusa.com/bluetooth). A limited number of compatible mobile phones is available for Office.

Contents are only displayed in full length when the vehicle is stationary.

The mobile phone has read-access only.



Do not use Office while driving

To avoid becoming distracted and posing an unnecessary hazard to your vehicle's occupants and to other road users, never attempt to use the controls or enter information unless traffic and road conditions allow this. ◀

### Requirements

- ▶ A suitable mobile phone is paired with the vehicle and connected. In some mobile phones, data access must be confirmed on the mobile phone.
- ▶ The time, time zone, and date, refer to page 81, are correctly set on the Control Display and on the mobile phone to correctly display appointments, for example.
- ▶ Office is activated, refer to page 211.

### Updating

Data are updated every time the mobile phone is connected to the vehicle. Appointment entries, tasks, notes and reminders can be updated separately.

1. "Office"
2. "Current office", "Calendar", "Tasks", "Notes" or "Reminders"
3. Open "Options".
4. "Update data"

Cell phone data are transmitted again to the vehicle.

## Office information

The number of unread messages and active tasks as well as the upcoming appointments are displayed.

1. "Office"
2. "Current office"
3. Select the desired entry to display details.

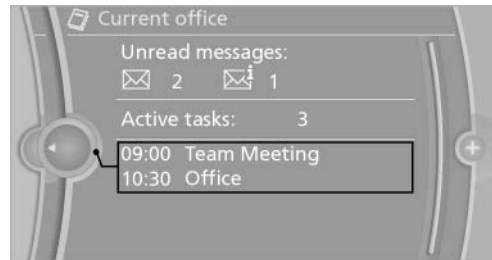

## Contacts

### At a glance

Contacts can be created and edited. The contacts from the mobile phone\* are displayed as well if this function is supported by the mobile phone. Addresses can be adopted as destinations for navigation and the phone numbers can be dialed.

### Displaying contacts

#### General information

1. "Office"

## 2. "Contacts"

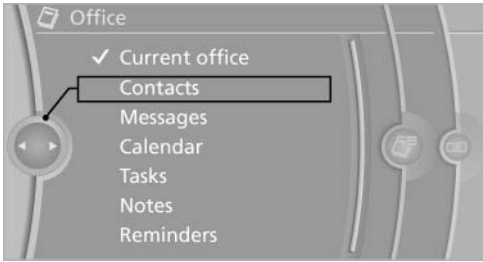

All contacts are listed in alphabetical order. Depending on the number of contacts, an A-Z search is offered, refer to page 24.

A symbol indicates the storage location of the contacts:

Symbol	Storage location
No symbol	In the vehicle; the address has not been checked as a destination.
	In the vehicle; the address has been checked as a destination.
	Mobile phone.

### Dialing phone numbers\*

1. Select the desired contact.
2. Select the phone number.  
The connection is established.

### Editing a contact

1. Select the desired contact.
2. "Edit contact"

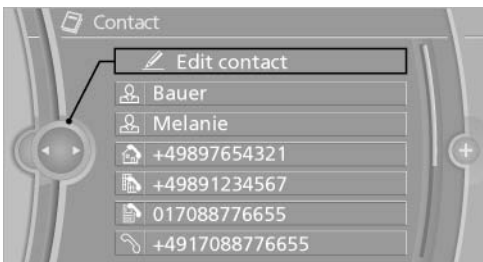

3. Change the entries.
4. "Store contact in vehicle"

When a contact is edited, the changes are not stored on the mobile phone. A copy of the entry is stored in the vehicle.

### Selecting the contact as a navigation destination\*

1. Select the desired contact.
2. Select the address.

When contacts from the mobile phone are used, the address may need to be matched to the navigation data contained in the vehicle. In this case:

Correct the address.

3. "Start guidance" or "Add as another destination"

### Checking the address as a destination\*

An address that is to be used for destination guidance must match the navigation data contained in the vehicle. The address can be checked for this purpose.

1. Select the desired contact and highlight the address.
2. Open "Options".
3. "Check as destination"
4. Correct and store the address if necessary.

If the address is corrected and stored, a copy of it is stored in the vehicle. The address is not changed on the mobile phone.

### New contact

#### General information

A contact can have up to 8 phone numbers, 2 addresses, 3 e-mail addresses and one Internet address.

1. "Office"
2. "Contacts"
3. Open "Options".

#### 4. "New contact"

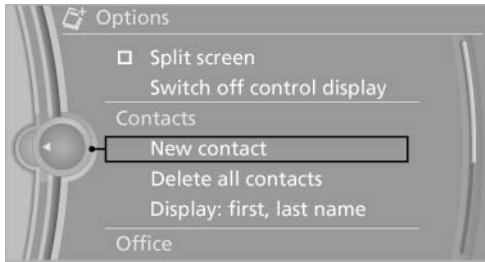

5. The entry fields are still filled with the previous entries: "Delete input fields"
6. Fill in the entry fields: select the symbol next to the entry field.
7. Enter the text and assign the contact type.
8. If the vehicle is equipped with a navigation system: Enter the address. Only addresses contained in the navigation data in the vehicle can be entered. This ensures that destination guidance is possible for all addresses.  
If necessary, "Accept address".
9. "Store contact in vehicle"

### Contact types

Various contact types can be assigned to phone numbers and addresses.

Symbol	Meaning
	Home phone number.
	Business phone number.
	Mobile phone number.
	Other phone number.
	Home address.
	Business address.

### Specifying the home address

A home address can be stored. It appears at the top of the contact list.

1. "Home"
2. Create a contact.

#### 3. "Store contact in vehicle"

### Selecting the sorting order of the names\*

Names can be displayed in a different order.

1. "Office"
2. "Contacts"
3. Open "Options".
4. "Display: last, first name" or "Display: first, last name"

Depending on how the contacts were stored on the mobile phone, the sorting order of the names may differ from the selected sorting order.

### Show contact pictures

Pictures stored with the contacts are stored in the vehicle when the mobile phone is connected to the vehicle. The number of transmitted pictures depends on the mobile phone. The mobile phone must support this function.

1. "Office"
2. "Contacts"
3. Open "Options".
4. "Show images"

Display of all contact pictures is activated or deactivated.

### Exporting/importing contacts

Contacts can be exported and imported via the Personal Profile, refer to page 33. The contacts stored in the vehicle are exported, but not those from the mobile phone.

### Deleting contacts

Only contacts that are stored in the vehicle are deleted. The contacts on the mobile phone\* cannot be deleted.

1. "Office"
2. "Contacts"
3. Highlight the contact.
4. Open "Options".

5. "Delete contact" or "Delete all contacts".
6. If necessary. "Yes"

## Messages

### General information

Whether or not text messages and e-mails from the mobile phone are displayed depends on whether transmission from the mobile phone to the vehicle is supported. Text messages and e-mails may not be supported by the service provider, or the function may need to be enabled separately. After the mobile phone is first paired, transmission may take several minutes. Messages are only displayed in full length when the vehicle is stationary. Messages from the additional telephone are not transmitted.

Display of different messages:

- ▷ Text messages.
- ▷ My Info\* messages from the BMW Assist Portal.
- ▷ Messages from the BMW Assist Concierge service\*.
- ▷ Messages from BMW Info\*.
- ▷ E-mails from the mobile phone.

### Displaying messages

1. "Office"
2. "Messages"

A symbol identifies the type of message.

Symbol	Message type
✉	Text messages.
✉	My Info
✉	Message from the Concierge service.
✉	Message from BMW Info.
✉@	E-mail from mobile phone.

### Filtering the message list

The message list can be filtered, when more than one type of message exists.

1. "Filter:"



2. Select the type of message.
  - ▷ "All"
    - All messages are displayed.
  - ▷ "E-mail"
    - Only e-mails from the mobile phone are displayed.
  - ▷ "Service message"
    - Only messages from the BMW Assist Concierge service, My Info and BMW Info are displayed.
  - ▷ "Text message"
    - Only text messages from the mobile phone are displayed.

### Deleting messages

Messages from the Concierge service, My Info, and BMW Info can be deleted.

Delete a message:

1. "Office"
2. "Messages"
3. Select the desired message.
4. Open "Options".
5. "Delete message"

Delete all messages:

1. "Office"
2. "Messages"

3. Open "Options".
4. "Delete all messages" or "Delete service messages"

## Text messages

### Calling the sender of a text message

1. Select the desired message.
2.  Select the symbol.

### Saving the sender in the contacts

1. Highlight the desired message.
2. Open "Options".
3. "Store as new contact" or "Add to existing contact"

### Reading the text message out loud\*

Read the text messages out loud, refer to page [228](#).



## My Info

### Starting destination guidance

1. Select the message.
2. "Start guidance" or "Add as another destination"

### Dialing the number in the message

Up to 4 phone numbers can be transmitted with a message.

1. Select the desired message.
2.  "Call":  
If the message contains a number, the connection is established.  
 "Select phone number":  
If the message contains more than one number, select the desired number from the list.  
The connection is established.

### Message from the Concierge service

#### Starting destination guidance

1. Select the desired message.



2.  "Start guidance" or "Add as another destination"



3. Start destination guidance, if necessary.

### Dialing the number in the message

Up to 4 phone numbers can be transmitted with a message.

1. Select the desired message.
2.  "Call":  
If the message contains a number, the connection is established.  
 "Select phone number":  
If the message contains more than one number, select the desired number from the list.  
The connection is established.

### Storing an address

1.  Select the desired message.
2. Open "Options".
3. "Store contact in vehicle"

### Displaying additional information

1. Select the desired message.
2. "Further information"



## BMW Info

### Starting destination guidance

1. Select the desired message.
2.  "Start guidance" or "Add as another destination"

### Dialing the number in the message

Up to 4 phone numbers can be transmitted with a message.

1. Select the desired message.
2.  "Call":  
If the message contains a number, the connection is established.  
 "Select phone number":  
If the message contains more than one number, select the desired number from the list. The connection is established.

## E-mail\*

### Displaying e-mails

1. "Office"
2. "Messages"
3. Select the desired e-mail.

### Displaying e-mail contacts

If the sender and recipient of an e-mail are transmitted by the mobile phone, this information is displayed in the e-mail.

 "Sender/Recipient"

If the e-mail addresses are stored in the contacts, the contact is displayed. Select the contact to display details.

If the e-mail addresses are not stored in the contacts, only the e-mail address is displayed.

### Using contact data

Contact data from appointments, e-mails and notes can be saved or selected\*, refer to page 228.

### Deactivating the full display

When an e-mail is opened in the vehicle, the e-mail is fully transmitted to the vehicle. This may result in charges.

1. "Office"
2. "Messages"
3. Open "Options".
4. "Fully download e-mails"  
Only a part of the email from the cell phone is loaded into the vehicle.

## Reading the e-mail out loud\*

Read the e-mail out loud, refer to page 228.

## Calendar

### Display the calendar

Appointments during the last 20 and the next 50 days can be displayed.

1. "Office"
2. "Calendar"  
The appointments on the current day are displayed.

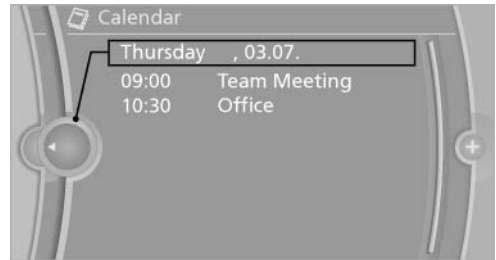

### Selecting the calendar day

1. Select the date.



2. Select the desired day or date.
  - ▷ "Next day"
  - ▷ "Date:"
  - ▷ "Previous day"
  - ▷ "Today"

### Display the appointment

1. Select the desired appointment.
2. Scroll through the appointment if necessary:
  - ▷ Turn the controller.
  - ▷   Select the symbol.

### Using contact data

Contact data from appointments, e-mails and notes can be saved or selected\*, refer to page 228.

## Reading the appointment out loud\*

Read the appointment out loud, refer to page 228.

## Tasks

### Displaying the task list

Display tasks that are due within the next 90 days.

1. "Office"
2. "Tasks"

### Sorting the task list

1. Select the header in the task list.

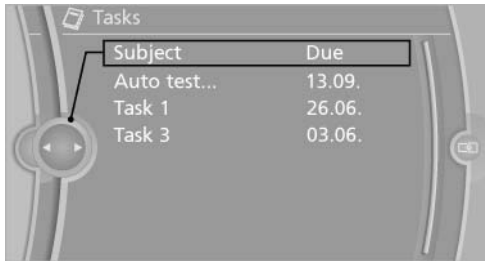

2. Select the sorting criterion:
  - ▷ "Priority (!)"\*
  - ▷ "Subject"
  - ▷ "Due date"

### Displaying the task

1. Select the desired task.
2. Scroll in the task if necessary:
  - ▷ Turn the controller.
  - ▷ Select the symbol.

### Using contact data

Contact data from appointments, e-mails and notes can be saved or selected\*, refer to page 228.

### Reading the task out loud\*

Read the task out loud, refer to page 228.

## Notes

### Displaying notes

1. "Office"
  2. "Notes"
- All notes are displayed.

### Displaying the note

1. Select the desired note.

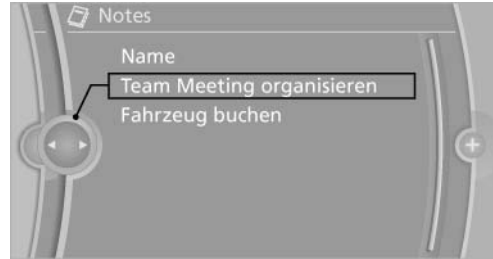

2. Scroll in the note if necessary:
  - ▷ Turn the controller.
  - ▷ Select the symbol.

### Using contact data

Contact data from appointments, e-mails and notes can be saved or selected\*, refer to page 228.

### Reading the note out loud\*

Read the note out loud, refer to page 228.

## Reminders

### Displaying reminders

Reminders of pending appointments and tasks are displayed. After an appointment or after a task is due, the reminder is no longer displayed.

1. "Office"
2. "Reminders"
3. Select the desired reminder.

The corresponding appointment or the task are displayed.

## Using contact data

### At a glance

Contact data from calendar entries, appointments, tasks, emails and notes can be stored or selected\*.

### Displaying contact or selecting phone number

1.  "Use contact data"
2. Display the contact or select the phone number:
  - ▷ Select the contact to display contact details.
  - ▷ Select the phone number to establish a connection directly.

### Storing contact data



1.  "Use contact data"
2. Highlight the phone number or e-mail address.
3. Open "Options".
4. "Add to existing contact" or "Store as new contact"

### Reading out loud\*

Text messages, e-mails, appointment entries, tasks, and notes can be read out loud.

1. Select the desired message, appointment, task, or note.
2.  Select the symbol.

The following options are available during reading:

- ▷  "Pause"  
Interrupt reading. Select again to restart reading.
- ▷  "Back to beginning"  
Start reading message again from the beginning.
- ▷  Select the symbol.  
Skip a paragraph.

- ▷  Select the symbol.  
Go back one paragraph.
- ▷ To end reading, tilt the controller to the left.

### What to do if...

Information on suitable mobile phones, refer to page 210.

Appointments, tasks, notes, text messages, or e-mails from the mobile phone are not displayed.

- ▷ The mobile phone is not capable of the missing function or is not connected correctly.
- ▷ The Office function is deactivated.
- ▷ The mobile phone is connected as an additional phone.
- ▷ Appointments are older than 20 days or are more than 50 days in the future.
- ▷ The tasks have been marked as completed or have a due date that lies more than 90 days in the future.
- ▷ Depending on the number of stored appointments, task notes, and messages in the mobile phone, not all are displayed in the vehicle.

Not all appointments and tasks from the mobile phone are displayed at the right time?

- ▷ The time zone, time or date is incorrectly set on the Control Display and mobile phone.

The e-mail attachment is not displayed.

- ▷ E-mails are transmitted without an attachment.

Entries are not displayed in full length.

- ▷ Text were already transmitted from the mobile phone in a shortened form.
- ▷ Synchronization between the mobile phone and vehicle may take several minutes.

The contact pictures are not being displayed?

- ▷ A max. of 200 contact pictures can be stored in the vehicle.

The E-mail is displayed with a delay?



- ▶ Check the e-mail settings on the telephone and adjust if necessary.

If all points in this list have been checked and the required function is still not available, please contact the hotline or service center.

# Contacts\*

## General information

Contacts can be created and edited and the addresses can be adopted as destinations for navigation.

## New contact

1. "Contacts"
2. "New contact"



3. The entry fields are still filled with the previous entries: "Delete input fields"
4. Fill in the entry fields: select the symbol next to the entry field.



5. Enter the text, refer to page 24.
6. If the vehicle is equipped with a navigation system: Enter the address. Only addresses contained in the navigation data in the vehicle can be entered. This ensures that destination guidance is possible for all addresses.
7. If necessary, "Store".
8. "Store contact in vehicle"

## Specifying the home address

A home address can be stored. It appears at the top of the contact list.

1. "Home"
2. Create a contact.
3. "Store contact in vehicle"

## My contacts

### General information

List of all contacts stored in the vehicle.

### Displaying contacts

1. "Contacts"
2. "My contacts"



All contacts are listed in alphabetical order. Depending on the number of contacts, an A-Z search is offered, refer to page 24.

A symbol indicates the storage location of the contacts:

Symbol	Storage location
No symbol	In the vehicle; the address has not been checked as a destination.
	In the vehicle; the address has been checked as a destination*.

## Editing a contact

1. Select the desired contact.
2. "Edit contact"



3. Change the entries.
4. Move the controller to the left.
5. "Yes"

## Selecting the contact as a navigation destination\*

1. Select the desired contact.
2. Select the address.
3. "Start guidance" or "Add as another destination"

## Checking the address as a destination\*

An address that is to be used for destination guidance must match the navigation data contained in the vehicle. The address can be checked for this purpose.

1. Select the desired contact and highlight the address.
2. Open "Options".
3. "Check as destination"
4. Correct and store the address if necessary.

## Selecting the sorting order of the names

Names can be displayed in a different order.

1. "My contacts"
2. Highlight the contact.
3. Open "Options".
4. "Display: last, first name" or "Display: first, last name"

## Exporting/importing contacts

Contacts can be exported and imported via the Personal Profile, refer to page 33.

## Deleting contacts

1. "My contacts"
2. Highlight the contact.
3. Open "Options".
4. "Delete contact" or "Delete all contacts"

# BMW ConnectedDrive

## BMW Assist\*

### General information

BMW Assist provides you with certain services, e.g., transmission of the position data of your vehicle to the BMW Assist Response Center if an Emergency Request\* has been initiated.

Many BMW Assist services depend on the individually agreed upon contract.

After your contract has expired, the BMW Assist system will be deactivated by the BMW Assist Response Center without your having to visit a service center. After the BMW Assist system has been deactivated, no BMW Assist services will be available. The BMW Assist system can be reactivated by a service center after you sign a new contract.

### Requirements

- ▷ The installed BMW Assist system is logged in to a wireless communications network. This network must be capable of transmitting the services.
- ▷ To transmit position data, the vehicle must be able to determine the current position.
- ▷ The BMW Assist service contract was signed with your service center or with the BMW Assist Response Center. Enabling must have been completed.
- ▷ BMW Assist is activated.

### Services offered

- ▷ **Emergency Request:** when you press the SOS button, a connection to the BMW Assist Response Center is established. The BMW Assist Response Center then speaks with you and takes further steps to help you.
- ▷ **Automatic Collision Notification:** under certain conditions, a connection is established to the BMW Assist Response Center after a serious accident. If possible, the BMW As-

ist Response Center then speaks with you and takes further steps to help you.

- ▷ **Enhanced Roadside Assistance:** BMW Roadside Assistance\* can be contacted if assistance is needed in the event of a breakdown. If possible, the vehicle and position data are transmitted in the process.
- ▷ **Customer Relations:** connection with Customer Relations for information on all aspects of your vehicle.
- ▷ **TeleService:** data on your vehicle's service status or required inspections are transmitted to your service center, either automatically before a service due date or when you request a BMW service appointment.
- ▷ **Remote Door Unlock:** the BMW Assist Response Center provides assistance if, for example, the remote control is not available and the vehicle needs to be opened.
- ▷ **Stolen Vehicle Recovery:** after you report that your vehicle was stolen to the police, the BMW Assist Response Center can determine its position.
- ▷ In addition to these services, the optional Convenience Plan offers Concierge service and information for route planning, traffic, and weather. A limited number of calls can be made via the BMW Assist Response Center with Critical Calling if, for example, the mobile phone is not available or discharged.

Press the SOS button to contact the BMW Assist Response Center.

## BMW TeleService\*

### General information

TeleService supports communication with your service center.

- ▷ Data on the vehicle's service requirements can be sent directly to the service center. In this way, the service center can plan its work

in advance. This shortens the duration of the service appointment.

- ▷ In the event of a breakdown, data on the vehicle's condition can be sent directly to Roadside Assistance.
- ▷ The service varies by country.
- ▷ Connection costs may ensue.
- ▷ Services may be restricted abroad.

## Requirements

- ▷ BMW Assist is activated.
- ▷ Wireless reception is available.
- ▷ The engine is running.

## Use of BMW TeleService\*

The TeleServices are typically activated in the vehicle.

Even TeleService Customer Service is not active, a voice contact to Roadside Assistance is still possible.

To continue using or to deactivate the services, please contact your service partner or the BMW customer hotline.

## Concierge service\*

### General information

The BMW Assist Concierge service offers information on events, gas stations or hotels, and provides phone numbers and addresses. Hotels can be booked directly by the BMW Assist Concierge service. The Concierge service is part of the optional BMW Convenience Plan.

### Starting the Concierge service

1. "ConnectedDrive"

2. "Concierge"



3. "Start service"

A voice connection is established with the BMW Assist Concierge service. Phone numbers and addresses can be transmitted to the vehicle.

## Roadside Assistance

### At a glance

BMW Roadside Assistance\* can be contacted if assistance is needed in the event of a breakdown.

Roadside Assistance\* can also be contacted via a Check Control message, refer to page 84.

### Starting Roadside Assistance

#### Vehicles not equipped with BMW Assist or BMW TeleService

1. "ConnectedDrive"
2. "Roadside Assistance"

The Roadside Assistance number is displayed. If the mobile phone\* is paired, a connection is established to Roadside Assistance.



## Vehicles equipped with BMW Assist or BMW TeleService

1. "ConnectedDrive"
2. "Roadside Assistance"
3. "Start service"

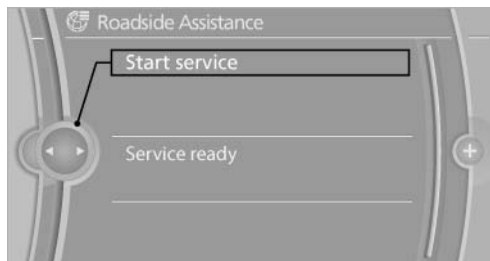

### TeleService Diagnosis\*

TeleService Diagnosis enables the wireless transmission of detailed vehicle data that are important for vehicle diagnosis. These data are transmitted automatically.

After the data are transmitted, the voice connection to Roadside Assistance is re-established.

### TeleService Help\*

TeleService Help enables an in-depth diagnosis of the vehicle by Roadside Assistance via wireless transmission.

TeleService Help can be started after a prompt by Roadside Assistance and the termination of the voice connection.

### Starting TeleService Help

1. Park the vehicle in a safe place.
2. Set the parking brake.
3. The engine is running.
4. "TeleService Help"

After completion of TeleService Help, a voice connection is established to Roadside Assistance.

## BMW Online\*

### At a glance

A business search can be opened via BMW Online.

#### License conditions

This product contains NetFront Browser software of ACCESS Co., Ltd. Copyright © 2007 ACCESS Co., Ltd. All rights reserved.

NetFront is a trademark or registered trademark of ACCESS CO., LTD., in Japan and other countries.

This software is based in part on the work of the Independent JPEG Group.

### Requirements

- ▷ Subscription to the optional Convenience Plan.
- ▷ The date setting, refer to page 81, on the Control Display is current.
- ▷ The vehicle is located within wireless network coverage.

### Starting BMW Online

1. "ConnectedDrive"
2. "BMW Online"

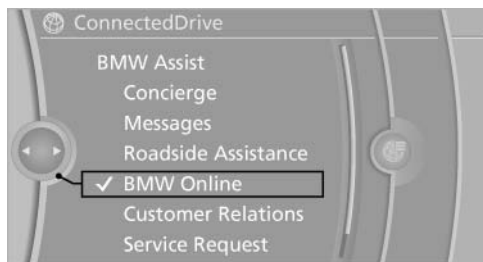

3. If necessary, "OK".

The BMW Online home page is displayed.

### Operating BMW Online

To start a search:

- ▷ Turn the controller to highlight an element.
- ▷ Press the controller to display an element.

## Opening the start page

1. Open "Options".
2. "Display start page"

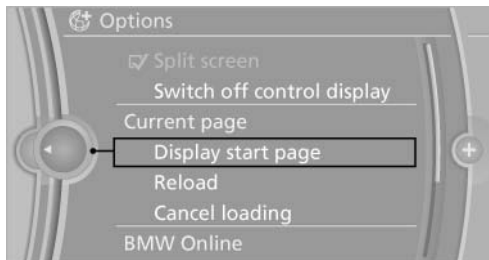

## Loading a new page

1. Open "Options".
2. "Reload"

## Cancel

1. Open "Options".
2. "Cancel loading"

## Customer Relations

### At a glance

Contact Customer Relations for information on all aspects of your vehicle.

### Calling Customer Relations

#### Vehicles not equipped with BMW Assist or BMW TeleService

1. "ConnectedDrive"
2. "Customer Relations"

The Customer Relations phone number is displayed. If the mobile phone\* is paired, a connection is established to Customer Relations.

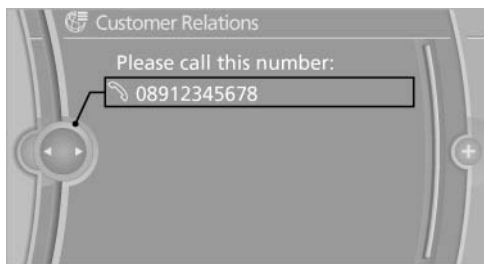

#### Vehicles equipped with BMW Assist or BMW TeleService

1. "ConnectedDrive"
2. "Customer Relations"
3. "Start service"

## Service Request\*

### At a glance

Sends information to your service partner to request the arrangement of a service appointment. The TeleService data is transmitted during a Service Request. If possible, your service partner will establish contact with you.

### Starting a Service Request

1. "ConnectedDrive"
2. "Service Request"
3. "Start service"

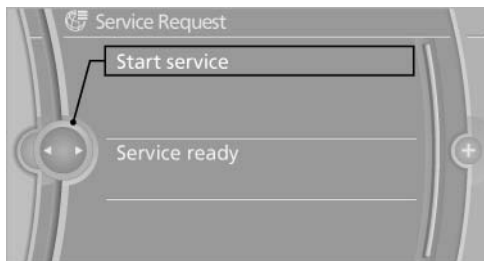

A Service Request can be started via a Check Control message, refer to page 84.

## Automatic Service Request\*

The TeleService data necessary for servicing the vehicle are automatically sent to your service partner prior to the service deadline. If possible, the service partner will contact you and a service appointment can be arranged.

To check when your service partner was notified:

1. "Vehicle Info"
2. "Vehicle status"

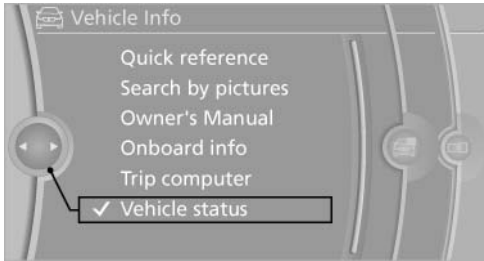

3. Open "Options".
4. "Last Service Request"

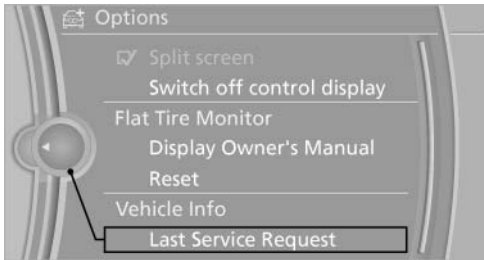

## Services status\*

### General information

Check services status.

### Displaying available services

Display of all services available in the vehicle.

1. "ConnectedDrive"
2. "Service Status"

3. "Available services"

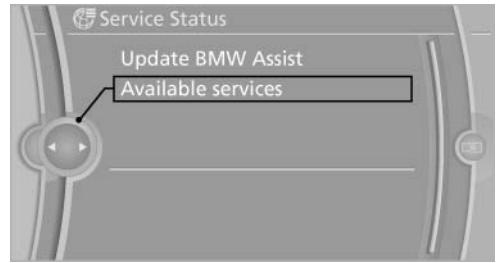

### Updating BMW Assist

Manual update of TeleService\* and BMW Assist\*.

"Update BMW Assist"

### Data transfer\*

During the updating of BMW services, display the status of the data transfer.

1. "ConnectedDrive"
2. Open "Options".
3. "Data transfer"

## Apps\*

### At a glance

Certain software applications of a suitable cell phone can be integrated in the vehicle. These software applications are displayed on the Control Display.

They are operated via iDrive.

### Requirements

- ▷ The mobile phone is suitable.
- ▷ The cell phone operating system supports the software applications of Apps.
- ▷ Software applications are installed on the cell phone and ready to use.
- ▷ Corresponding mobile wireless contract.  
Any additionally incurred costs are not a part of Apps.



- ▶ Use only BMW approved software applications; otherwise, it may result in malfunctions.

Information about suitable cell phones, available software applications and their installation can be found at [www.bmw.com/connectivity](http://www.bmw.com/connectivity) or at the service center.



Create the entries.

Make entries only when traffic and road conditions allow. Otherwise, the vehicle occupants and other road users may be put in danger because of the distraction from driving.

For reasons of safety, some software applications are usable only while the vehicle is stationary. ◀

## Operate Apps

1. Connect the cell phone via the snap-in adapter or via the USB audio interface.
2. "ConnectedDrive"
3. Select the desired software application.

## Displaying status

Information about the currently available software applications can be displayed.

1. "ConnectedDrive"
2. "BMW apps"

## PlugIn\*

Selected functions of the cell phone are displayed on the Control Display. They can be operated via iDrive.

1. Connect cell phone via the snap-in adapter.
2. "ConnectedDrive"
3. "PlugIn"
4. "Activate PlugIn"
5. Navigate to the displayed functions via the controller and select, for example, a desired category or track.



Press button to switch within the cell phone functions to a higher level or back.



Press button twice to switch back to the main menu.

## Notes

- ▶ The ranges of Apps that can be displayed on the Control Display depend on the range of installed software applications on the cell phone.
- ▶ The data transmission of the software applications from the cell phone to the vehicle can last some time. Some software applications depend on the speed of the available Internet connection of the cell phone.
- ▶ Some cell phones cannot simultaneously use Apps and the Bluetooth hands-free system.

If necessary, restart the software application on the cell phone after a phone conversation.

## TeleService Report\*

Transmits technical data that is evaluated for the ongoing development of BMW products from your vehicle to BMW in regular intervals if necessary.

TeleService Report is activated in vehicles that meet certain technical requirements and have a valid Assist contract; this feature is free of charge.

Neither personal data nor position data is transmitted.

Indicate when the last Teleservice Report was transmitted:

1. "Vehicle Info"
2. "Vehicle status"
3. Open "Options".
4. "Last Teleservice Info"





## Mobility

To ensure that you remain mobile at all times, this chapter supplies you with important information on the topics of fuels and lubricants, wheels and tires, service, maintenance, and Roadside Assistance.

# Refueling

## Fuel cap

### Opening

1. Briefly press the rear edge of the fuel filler flap.

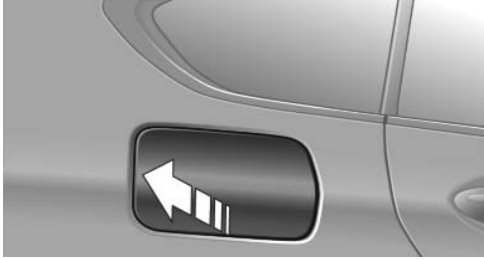

2. Turn the fuel cap counterclockwise.

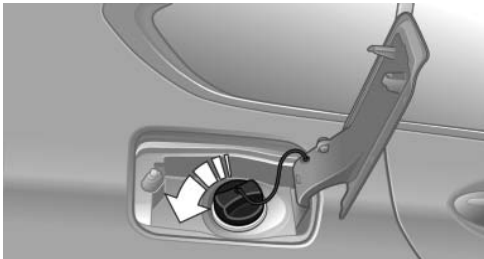

3. Place the fuel cap in the bracket attached to the fuel filler flap.

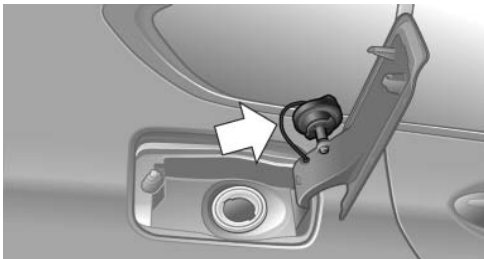

### Closing

1. Fit the cap and turn it clockwise until you clearly hear a click.
2. Close the fuel filler flap.



Do not pinch the retaining strap

Do not pinch the retaining strap attached to the cap; otherwise, the cap cannot be closed properly and fuel vapors can escape.

A message is displayed if the cap is loose or missing. ◀

### Manually unlocking fuel filler flap

In the event of an electrical malfunction, for example.

1. Open the cover on the right side trim.

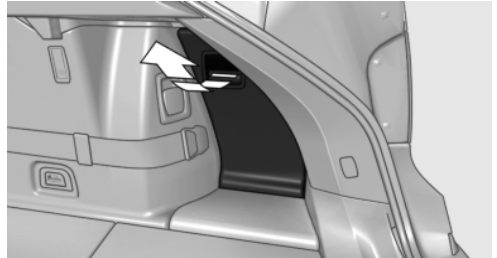

2. Pull the green knob with the fuel pump symbol. This releases the fuel filler flap.

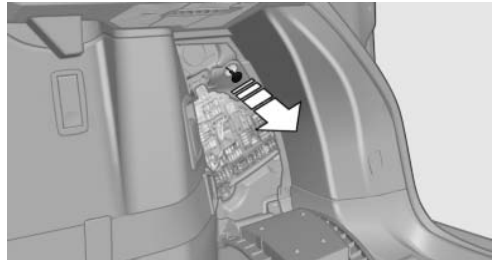

### Observe the following when refueling

The fuel tank is full when the filler nozzle clicks off the first time.



Handling fuels

Obey safety regulations posted at the gas station. ◀

## Fuel tank capacity

Fuel tank capacity: approx. 18.5 US gal/70 liters.





Refuel promptly

Refuel below a range of 30 miles/50 km; otherwise, engine functions are not ensured and damage may occur. ◀

# Fuel

## Fuel quality

 Refuel with unleaded fuel only  
Do not use leaded fuel as this would permanently damage the catalytic converter. ◀

 Do not refuel with ethanol  
Do not refuel with E85, i.e., fuel with an ethanol content of 85 %, or with Flex Fuel, as this would damage the engine and fuel supply system. ◀

## Required fuel

### Super Premium Gasoline/AKI 91 or AKI 89

BMW recommends AKI 91 or 89.

### Gasoline with lower AKI

The minimum AKI Rating is 89.

If you use gasoline with this minimum AKI Rating, the engine may produce knocking sounds when starting at high outside temperatures.

This has no effect on the engine life.

 Minimum fuel grade  
Do not use any gasoline below the minimum specified fuel grade; otherwise, engine damage may occur. ◀

## Use high-quality brands

Field experience has indicated significant differences in fuel quality: volatility, composition, additives, etc., among gasolines offered for sale in the United States and Canada.

Fuels containing up to and including 10 % ethanol or other oxygenates with up to 2.8 % oxygen by weight, that is, 15 % MTBE or 3 % methanol plus an equivalent amount of co-solvent, will not void the applicable warranties with respect to defects in materials or workmanship.

 Minimum fuel grade  
The use of poor-quality fuels may result in driveability, starting and stalling problems especially under certain environmental conditions such as high ambient temperature and high altitude.

Should you encounter driveability problems which you suspect could be related to the fuel you are using, we recommend that you respond by switching to a recognized high-quality brand such as gasoline that is advertised as Top Tier Detergent Gasoline.

Failure to comply with these recommendations may result in unscheduled maintenance. ◀

**BMW** recommends BP fuels 

# Wheels and tires

## Tire inflation pressure

### Safety information

The tire characteristics and tire inflation pressure influence the following:

- ▷ The service life of the tires.
- ▷ Road safety.
- ▷ Driving comfort.

### Checking the pressure

Only check the tire inflation pressure when the tires are cold. This means after driving no more than 1.25 miles/2 km or when the vehicle has been parked for at least 2 hours. When the tires are warm, the tire inflation pressure is higher.

 Check the tire inflation pressure regularly  
Regularly check the tire inflation pressure and correct it as needed: at least twice a month and before a long trip. If you fail to observe this precaution, you may be driving on tires with incorrect tire pressures, a condition that may not only compromise your vehicle's driving stability, but also lead to tire damage and the risk of an accident. ◀

After correcting the tire inflation pressure, reinitialize the Tire Pressure Monitor.

### Pressure specifications

The tire inflation pressure table, refer to page 243, contains all pressure specifications for the specified tire sizes at the ambient temperature. Pressure specifications apply to approved tire sizes and recommended tire brands. This information can be obtained from your service center.

To identify the correct tire inflation pressure, please note the following:

- ▷ Tire sizes of your vehicle.
- ▷ Vehicle load.
- ▷ Maximum allowable driving speed.

## Tire inflation pressures up to 100 mph/160 km/h

For speeds of up to 100 mph/160 km/h and for optimum driving comfort, note the pressure values in the tire inflation pressure table, refer to page 243, and adjust as necessary.

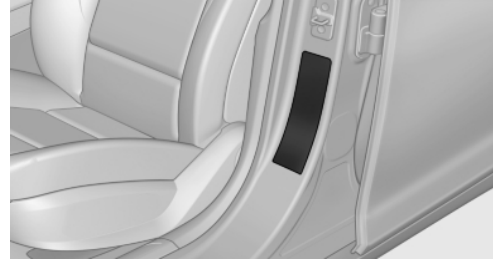

These pressure values can also be found on the tire inflation pressure label on the driver's door pillar.

 Maximum permissible speed  
Do not exceed 100 mph/160 km/h; otherwise, tire damage and accidents may result. ◀

## Tire inflation pressure values up to 100 mph/160 km/h

### 535i, 550i

Tire size	Pressure specifications in bar/PSI
Specifications in bar/PSI with cold tires	
245/50 R 18 100 Y	2.2 / 32    2.4 / 35
245/50 R 18 100 V M +S A/S	
245/50 R 18 100 H M +S	

Tire size	Pressure specifications in bar/PSI	
245/45 R 19 102 V M +S XL A/S	2.4 / 35	2.6 / 38
245/45 R 19 102 V M +S XL		
F.: 245/45 R 19 98 Y	2.2 / 32	-
R.: 275/40 R 19 101 Y	-	2.4 / 35
F.: 245/40 R 20 99 Y XL	2.4 / 35	-
R.: 275/35 R 20 102 Y XL	-	2.6 / 38
F.: 245/35 R 21 96 Y XL	2.6 / 38	-
R.: 275/30 R 21 98 Y XL	-	3.0 / 44

## 550i xDrive

Tire size	Pressure specifications in bar/PSI	
Specifications in bar/PSI with cold tires		
245/50 R 18 100 Y	2.2 / 32	2.4 / 35
245/50 R 18 100 V M +S A/S		
245/50 R 18 100 H M +S		
245/45 R 19 102 V M +S XL A/S	2.4 / 35	2.6 / 38
245/45 R 19 102 V M +S XL		
F.: 245/45 R 19 98 Y	2.4 / 35	-
R.: 275/40 R 19 101 Y	-	2.4 / 35

Tire size	Pressure specifications in bar/PSI	
F.: 245/40 R 20 99 Y XL	2.6 / 38	-
R.: 275/35 R 20 102 Y XL	-	2.6 / 38
F.: 245/35 R 21 96 Y XL	2.8 / 41	-
R.: 275/30 R 21 98 Y XL	-	3.0 / 44

## Tire inflation pressures at max. speeds above 100 mph/160 km/h



Speeds above 100 mph/160 km/h

In order to drive at maximum speeds in excess of 100 mph/160 km/h, please observe, and, if necessary, adjust tire pressures for speeds exceeding 100 mph/160 km/h from the relevant table on the following pages. Otherwise tire damage and accidents could occur. ◀

## Tire inflation pressure values over 100 mph/160 km/h

### 535i, 550i

Without high-speed tuning feature

Tire size	Pressure specifications in bar/PSI	
Specifications in bar/PSI with cold tires		
245/50 R 18 100 Y	2.3 / 33	2.8 / 41
245/50 R 18 100 V M +S A/S		
245/50 R 18 100 H M +S		
245/45 R 19 102 V M +S XL A/S	2.7 / 39	3.2 / 46
245/45 R 19 102 V M +S XL		



Tire size	Pressure specifications in bar/PSI	
F.: 245/45 R 19 98 Y	2.3 / 33	-
R.: 275/40 R 19 101 Y	-	2.5 / 36
F.: 245/40 R 20 99 Y	2.5 / 36	-
XL	-	2.8 / 41
R.:		
275/35 R 20 102 Y XL		
F.:	2.9 / 42	-
245/35 R 21 96 Y XL	-	3.2 / 46
R.:		
275/30 R 21 98 Y XL		

#### With high-speed tuning feature

Tire size	Pressure specifications in bar/PSI	
Specifications in bar/PSI with cold tires		
245/50 R 18 100 Y	2.3 / 33	2.8 / 41
245/50 R 18 100 H M +S		
245/45 R 19 102 V M +S XL	2.7 / 39	3.2 / 46
F.: 245/45 R 19 98 Y	2.4 / 35	-
R.: 275/40 R 19 101 Y	-	2.6 / 38
F.: 245/40 R 20 99 Y	2.6 / 38	-
XL	-	2.8 / 41
R.:		
275/35 R 20 102 Y XL		
F.:	2.9 / 42	-
245/35 R 21 96 Y XL	-	3.3 / 48
R.:		
275/30 R 21 98 Y XL		

### 550i xDrive

#### Without high-speed tuning feature

Tire size	Pressure specifications in bar/PSI	
Specifications in bar/PSI with cold tires		
245/50 R 18 100 Y	2.3 / 36	2.7 / 39
245/50 R 18 100 V M +S A/S		
245/50 R 18 100 H M +S		
245/45 R 19 102 V M +S XL A/S	2.5 / 36	2.9 / 42
245/45 R 19 102 V M +S XL		
F.: 245/45 R 19 98 Y	2.4 / 35	-
R.: 275/40 R 19 101 Y	-	2.4 / 35
F.: 245/40 R 20 99 Y	2.6 / 38	-
XL	-	2.6 / 38
R.:		
275/35 R 20 102 Y XL		
F.:	2.8 / 41	-
245/35 R 21 96 Y XL	-	3.0 / 44
R.:		
275/30 R 21 98 Y XL		

#### With high-speed tuning feature

Tire size	Pressure specifications in bar/PSI	
Specifications in bar/PSI with cold tires		
245/50 R 18 100 Y	2.5 / 36	2.8 / 41
245/50 R 18 100 H M +S		

Tire size	Pressure specifications in bar/PSI	
245/45 R 19 102 V M +S XL A/S	2.8 / 41	3.2 / 46
245/45 R 19 102 V M +S XL		
F.: 245/45 R 19 98 Y	2.5 / 36	-
R.: 275/40 R 19 101 Y	-	2.5 / 36
F.: 245/40 R 20 99 Y XL	2.8 / 41	-
R.: 275/35 R 20 102 Y XL	-	2.8 / 41
F.: 245/35 R 21 96 Y XL	3.0 / 44	-
R.: 275/30 R 21 98 Y XL	-	3.2 / 46

## Tire identification marks

### Tire size

255/50 R 19 103 Y

255: nominal width in mm

50: aspect ratio in %

R: radial tire code

19: rim diameter in inches

103: load rating, not for ZR tires

Y: speed rating, before the R on ZR tires

### Speed letter

T = up to 118 mph, 190 km/h

H = up to 131 mph, 210 km/h

V = up to 150 mph, 240 km/h

W = up to 167 mph, 270 km/h

Y = up to 186 mph, 300 km/h

### Tire Identification Number

DOT code: DOT xxxx xxx 3510

xxxx: manufacturer code for the tire brand

xxx: tire size and tire design

3510: tire age

Tires with DOT codes meet the guidelines of the U.S. Department of Transportation.

### Tire age

DOT ... 3510: the tire was manufactured in the 35th week in 2010.

### Recommendation

Regardless of wear, replace tires at least every 6 years.

### Uniform Tire Quality Grading

Quality grades can be found where applicable on the tire sidewall between tread shoulder and maximum section width.

For example: Treadwear 200; Traction AA; Temperature A

### DOT Quality Grades

Treadwear

Traction AA A B C

Temperature A B C

All passenger car tires must conform to Federal Safety Requirements in addition to these grades.

### Treadwear

The treadwear grade is a comparative rating based on the wear rate of the tire when tested under controlled conditions on a specified government test course. For example, a tire graded 150 would wear one and one-half, 1 g, times as well on the government course as a tire graded 100. The relative performance of tires depends upon the actual conditions of their use, however, and may depart significantly from the norm due to variations in driving habits, service practices and differences in road characteristics and climate.

### Traction

The traction grades, from highest to lowest, are AA, A, B, and C.

Those grades represent the tire's ability to stop on wet pavement as measured under controlled conditions on specified government test surfaces of asphalt and concrete. A tire marked C may have poor traction performance.

The traction grade assigned to this tire is based on straight-ahead braking traction tests, and does not include acceleration, cornering, hydroplaning, or peak traction characteristics.

## Temperature

The temperature grades are A, the highest, B, and C, representing the tire's resistance to the generation of heat and its ability to dissipate heat when tested under controlled conditions on a specified indoor laboratory test wheel. Sustained high temperature can cause the material of the tire to degenerate and reduce tire life, and excessive temperature can lead to sudden tire failure. The grade C corresponds to a level of performance which all passenger car tires must meet under the Federal Motor Vehicle Safety Standard No. 109. Grades Band A represent higher levels of performance on the laboratory test wheel than the minimum required by law.



Temperature grade for this tire

The temperature grade for this tire is established for a tire that is properly inflated and not overloaded. Excessive speed, underinflation, or excessive loading, either separately or in combination, can cause heat buildup and possible tire failure.

If necessary, have the vehicle towed. ◀

## RSC – Run-flat tires

Run-flat tires, refer to page 249, are labeled with a circular symbol containing the letters RSC marked on the sidewall.

## M+S

Winter and all-season tires with better cold weather performance than summer tires.

## Tire tread

### Summer tires

Do not drive with a tire tread depth of less than 0.12 in/3 mm.

There is an increased danger of hydroplaning if the tread depth is less than 0.12 in/3 mm.

### Winter tires

Do not drive with a tire tread depth of less than 0.16 in/4 mm.

Below a tread depth of 0.16 in/4 mm, tires are less suitable for winter operation.

### Minimum tread depth

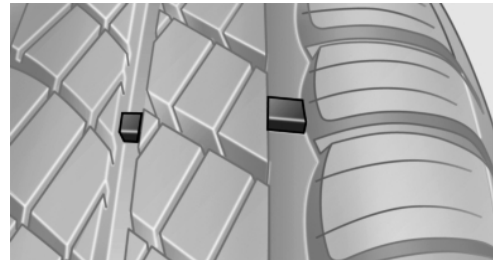

Wear indicators are distributed around the tire's circumference and have the legally required minimum height of 0.063 in/1.6 mm.

They are marked on the side of the tire with TWI, Tread Wear Indicator.

## Tire damage

### General information

Inspect your tires often for damage, foreign objects lodged in the tread, and tread wear.

### Notes

Indications of tire damage or other vehicle defects:

- ▷ Unusual vibrations during driving.
- ▷ Unusual handling such as a strong tendency to pull to the left or right.



## In case of tire damage

If there are indications of tire damage, reduce your speed immediately and have the wheels and tires checked right away; otherwise, there is the increased risk of an accident.

Drive carefully to the next service center or tire shop.

If necessary, have the vehicle towed. ◀



## Repair of tire damage

For safety reasons, the manufacturer of your vehicle recommends that you do not have damaged tires repaired; they should be replaced. Otherwise, damage can occur as a result. ◀

## Changing wheels and tires

### Mounting



#### Information on mounting tires

Have mounting and balancing performed only by a service center or tire specialist.

If this work is not carried out properly, there is the danger of subsequent damage and related safety hazards. ◀

### Wheel and tire combination

Information on the correct wheel-tire combination and rim versions for your vehicle can be obtained from your service center.

Incorrect wheel and tire combinations impair the function of a variety of systems such as ABS or DSC.

To maintain good handling and vehicle response, use only tires with a single tread configuration from a single manufacturer.

Following tire damage, have the original wheel and tire combination remounted on the vehicle as soon as possible.



## Approved wheels and tires

The manufacturer of your vehicle recommends that you use only wheels and tires that have been approved for your particular vehicle model.

For example, despite having the same official size ratings, variations can lead to body contact and with it, the risk of severe accidents.

The manufacturer of your vehicle cannot evaluate non-approved wheels and tires to determine if they are suited for use, and therefore cannot ensure the operating safety of the vehicle if they are mounted. ◀

### Recommended tire brands



For each tire size, the manufacturer of your vehicle recommends certain tire brands. These can be identified by a star on the tire sidewall.

With proper use, these tires meet the highest standards for safety and handling.

### New tires

Due to technical factors associated with their manufacture, tires do not achieve their full traction potential until after an initial breaking-in period.

Drive conservatively for the first 200 miles/300 km.

### Retreaded tires

The manufacturer of your vehicle does not recommend the use of retreaded tires.



### Retreaded tires

Possibly substantial variations in the design and age of the tire casing structures can limit service life and have a negative impact on road safety. ◀

## Winter tires

The manufacturer of your vehicle recommends winter tires for winter roads or at temperatures below +45 °F/+7 °C.

Although so-called all-season M+S tires do provide better winter traction than summer tires, they do not provide the same level of performance as winter tires.

## Maximum speed of winter tires

If the maximum speed of the vehicle is higher than the permissible speed for the winter tires, then display a corresponding sign in the field of vision. You can obtain this sign from the tire specialist or from your service center.



### Maximum speed for winter tires

Do not exceed the maximum speed for the winter tires; otherwise, tire damage and accidents can occur. ◀

## Run-flat tires

For your own safety, only use run-flat tires. No spare tire is available in the case of a flat tire. Your service center will be glad to advise you.

## Rotating wheels between axles

The manufacturer of your vehicle advises against swapping wheels between the front and rear axles.

This can impair the handling characteristics.

## Storage

Store wheels and tires in a cool, dry place with as little exposure to light as possible.

Always protect tires against all contact with oil, grease and fuels.

Do not exceed the maximum tire inflation pressure indicated on the side wall of the tire.

## Run-flat tires\*

### Label



RSC label on the tire sidewall.

The wheels are composed of special rims and tires that are self-supporting, to a limited degree.

The support of the sidewall allows the tire to remain drivable to a restricted degree in the event of a pressure loss.

Continued driving with a damaged tire., refer to page 94

## Changing run-flat tires

For your own safety, only use run-flat tires. No spare tire is available in the case of a flat tire. Your service center will be glad to advise you.

## Snow chains

### Fine-link snow chains

Only certain types of fine-link snow chains have been tested by the manufacturer of your vehicle, classified as road-safe and recommended.

Consult your service center for more information.

### Use

Use only in pairs on the rear wheels, equipped with the tires of the following size:

- ▷ 245/50 R 18.
- ▷ 245/45 R 19.

Follow the chain manufacturer's instructions.

Make sure that the snow chains are always sufficiently tight. Retighten as needed according to the chain manufacturer's instructions.

Do not initialize the Tire Pressure Monitor after mounting snow chains, as doing so may result in incorrect readings.

When driving with snow chains, briefly activate Dynamic Traction Control if necessary.

## Maximum speed with snow chains

Do not exceed a speed of 30 mph/50 km/h when using snow chains.

## Snow chain detection\*

### The concept

When using snow chains, you should set whether you are driving with or without snow chains via the iDrive.

The snow chain detection system supports you by automatically showing the detected state on the Control Display.

When snow chains are in use, the rear axle steering of the Integral Active Steering\* is deactivated automatically.

At speeds above the maximum allowable speed with snow chains of 30 mph/50 km/h, the rear axle steering is activated again automatically.

### Activating the status

1. "Settings"
2. "Tire chains"
3. "Tire chains installed"

### Automatic detection

If functioning properly:

- ▷ Snow chains are mounted. The setting is not activated  .

After you drive a short distance, a Check Control message is shown and the state is activated automatically.

Confirm the automatic activation.

- ▷ Snow chains are not mounted. The setting is activated  .

At speeds above 30 mph/50 km/h, a Check Control message is displayed. Deactivate the status manually.

If not functioning properly:

- ▷ Snow chains are mounted. The setting is not activated  .

A Check Control message is not displayed.

The automatic detection system is malfunctioning. Activate the status manually.

### Activating/deactivating rear axle steering

If the status indicating that snow chains are in use is activated, the rear axle steering is deactivated automatically.

At speeds above 30 mph/50 km/h, the rear axle steering is activated again, even though snow chains are in use.

# Engine compartment

## Important features in the engine compartment

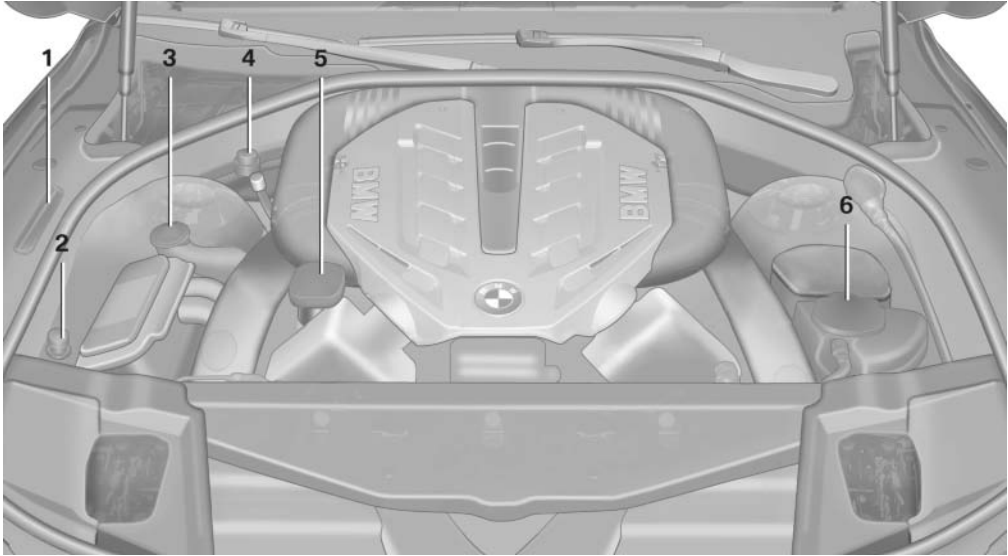

- |   |                                  |   |                                  |
|---|----------------------------------|---|----------------------------------|
| 1 | Vehicle identification number*   | 4 | Jump starting, positive terminal |
| 2 | Jump starting, negative terminal | 5 | Oil filler neck                  |
| 3 | Washer fluid reservoir           | 6 | Coolant reservoir                |

## Hood

### Opening the hood

 Working in the engine compartment

Never attempt to perform any service or repair operations on your vehicle without the necessary professional technical training.

If you are unfamiliar with the statutory guidelines, have any work on the vehicle performed only by a service center.

If this work is not carried out properly, there is the danger of subsequent damage and related safety hazards. ◀

 Never reach into the engine compartment  
Never reach into the intermediate spaces or gaps in the engine compartment. Otherwise, there is risk of injury, e.g. from rotating or hot parts. ◀

1. Pull the lever.

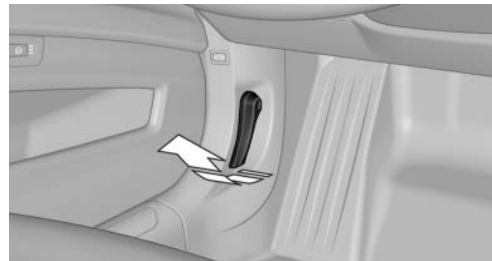

2. Press the release handle and open the hood.

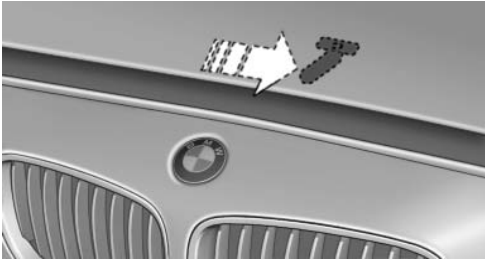

3. Be careful of protruding parts on the hood.



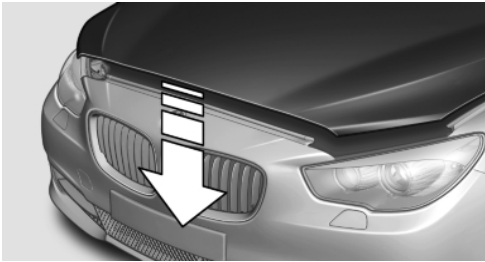

-  Danger of injury when the hood is open  
There is a danger of injury from protruding parts when the hood is open. ◀

### Closing the hood



Let the hood drop from a height of approx. 16 in/ 40 cm and push down on it to lock it fully.  
The hood must audibly engage on both sides.

-  Hood open when driving  
If you see any signs that the hood is not completely closed while driving, pull over immediately and close it securely. ◀

-  Danger of pinching  
Make sure that the closing path of the hood is clear; otherwise, injuries may result. ◀



# Engine oil

## General information

The engine oil consumption is dependent on the driving style and driving conditions.

Therefore, check the engine oil level after every refueling using the electronic engine oil level check.

## Checking the oil level

### The concept

The oil level is monitored electronically and displayed on the Control Display.

### Requirements

- ▷ The engine must be running and warm after the vehicle has been driven for at least 6 miles/10 km.
- ▷ The vehicle is stopped or being driven on a level roadway.

### Displaying the oil level

1. "Vehicle Info"
2. "Vehicle status"
3. "Engine oil level"

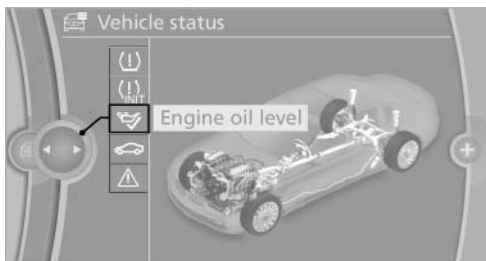

### Possible messages

- ▷ "Engine oil level OK"
- ▷ "Measurement not possible at this time."
- ▷ "Measuring engine oil level..."

Duration with the engine running; approx. 3 minutes.

Duration while driving: approx. 5 minutes.

- ▷ "Engine oil level below minimum. Add 1 quart!"  
Add oil within the next 125 miles/200 km.
- ▷ "Engine oil level too high! Have this checked."  
Have the vehicle checked immediately.

 Too much engine oil  
Have the vehicle checked immediately; otherwise, surplus oil can lead to engine damage. ◀

- ▷ "Measurement inactive. Have this checked."  
Note the newly calculated remaining mileage until the next oil service. Have the system checked as soon as possible.

## Adding engine oil

### Filler neck

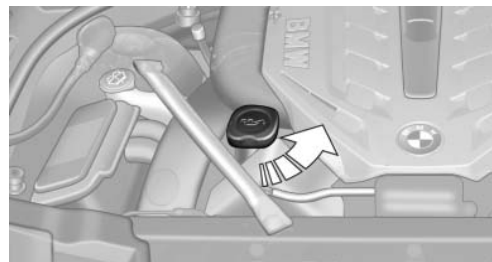



When the indicator lights up in the instrument cluster, add 1 US quart/liter of engine oil within the next 125 miles/200 km.

Recommended oil types, refer to page 254.

 Protect children  
Keep oil, grease, etc., out of reach of children and heed the warnings on the containers to prevent health risks. ◀

## Oil types

### Note

-  No oil additives
-  Oil additives may lead to engine damage. ◀

### Approved oil types

Your service center can advise you on which engine oils have been approved by the manufacturer of your vehicle.

The engine oil quality is critical for the life of the engine.

Only use approved BMW High Performance oil.

Approved oils belong to the viscosity grades SAE 0W-40, SAE 0W-30, SAE 5W-40 and SAE 5W-30.

### Alternative oil types



If the approved engine oils are not available, up to 1 US quart/liter of another oil with the following specification may be used.



API SM quality standards or higher.

**BMW recommends** 

## Coolant

### General information

-  Danger of burns from hot engine
-  Do not open the cooling system while the engine is hot; otherwise, escaping coolant may cause burns. ◀

-  Suitable additives
-  Only use suitable additives; otherwise, engine damage may occur. The additives are harmful to your health. ◀

Coolant consists of water and additives.

Not all commercially available additives are suitable for your vehicle. Ask your service center for suitable additives.

### Coolant level

If there is no Min- and Max- mark in the filler neck of the coolant reservoir, have the coolant level checked if necessary by your service center and add coolant as needed.

### Checking

1. Let the engine cool.
2. Turn the cap of the coolant reservoir slightly counterclockwise to allow any excess pressure to dissipate, and then open it.

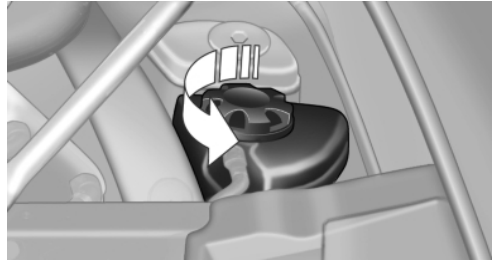

3. The coolant level is correct if it lies between the minimum and maximum marks in the filler neck.



4. If the coolant is low, slowly add coolant up to the specified level; do not overfill.

5. Turn the cap until there is an audible click.
6. Have the cause of the coolant loss eliminated as soon as possible.

## Disposal



Comply with the relevant environmental protection regulations when disposing of coolant and coolant additives.

# Maintenance

## BMW Maintenance System

The maintenance system directs you to required maintenance measures and thereby supports you in maintaining road safety and the operational reliability of the vehicle.

## Condition Based Service CBS

Sensors and special algorithms take into account the driving conditions of your vehicle. Based on this, Condition Based Service determines the maintenance requirements.

The system makes it possible to adapt the amount of maintenance you need to your user profile.

Details on the service requirements, refer to page 82, can be displayed on the Control Display.

### Service data in the remote control

Information on the required maintenance is continuously stored in the remote control. Your service center will read out this data and suggest the right array of service procedures for your vehicle.

Therefore, hand your service specialist the remote control that you used most recently.

### Storage periods

Storage periods during which the vehicle battery was disconnected are not taken into account.

If this occurs, have a service center update the time-dependent maintenance procedures, such as checking brake fluid and, if necessary, changing the engine oil and the microfilter/activated-charcoal filter.

## Service and Warranty Information Booklet for US models and Warranty and Service Guide Booklet for Canadian models

Please consult your Service and Warranty Information Booklet for US models and Warranty and Service Guide Booklet for Canadian models for additional information on service requirements.

Maintenance and repair should be performed by your service center. Make sure to have regular maintenance procedures recorded in the vehicle's Service and Warranty Information Booklet for US models, and in the Warranty and Service Guide Booklet for Canadian models. These entries are proof of regular maintenance.

## Socket for OBD Onboard Diagnosis

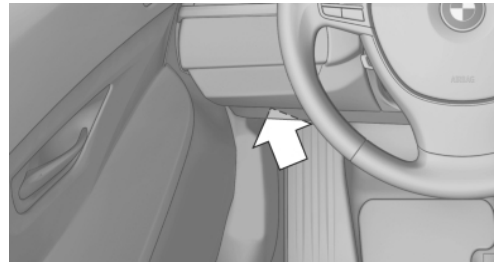

There is an OBD socket on the driver's side for checking the primary components in the vehicle emissions.

## Emissions



- ▷ The warning lamp lights up: Emissions are deteriorating. Have the vehicle checked as soon as possible.



- ▷ The warning lamp flashes under certain circumstances:

This indicates that there is excessive misfiring in the engine.

Reduce the vehicle speed and have the system checked immediately; otherwise, serious engine misfiring within a brief period can seriously damage emission control components, in particular the catalytic converter.

## Fuel cap



The indicator lamp lights up.

If the fuel cap is not properly tightened, the OBD system may conclude that fuel vapor is escaping. If the cap is then tightened, the display should go out in a short time.

## Data memory

Your vehicle records data relating to vehicle operation, faults and user settings. These data are stored in the remote control and can be read out with suitable devices, particularly when the vehicle is serviced. The data obtained in this way provide valuable information for service processes and repair or for optimizing and developing vehicle functions further.

In addition, if you signed a service contract for Assist, certain vehicle data can be sent directly from the vehicle to facilitate the desired services.

## Replacing components

### Tool kit



The tool kit is located in the rear compartment in the cargo area, refer to page 142.

3. Position the wiper blade in a horizontal position.
4. Remove the wiper blade toward one side.



### Wiper blade replacement

 Do not fold down the wipers without wiper blades

Do not fold down the wipers if wiper blades have not been installed; this may damage the windshield. ◀

#### Replacing the wiper blades

1. To change the wiper blades, fold up, refer to page 73, the wiper arms.
2. Fold up the wipers.



### Lamp and bulb replacement

#### General information

Lamps and bulbs make an essential contribution to vehicle safety.

The manufacturer of your vehicle recommends that you entrust corresponding procedures to your service center if you are unfamiliar with them or they are not described here.

You can obtain a selection of replacement bulbs at your service center.

 Danger of burns

Only change bulbs when they are cool; otherwise, there is the danger of getting burned. ◀

 Working on the lighting system

When working on the lighting system, you should always switch off the lights affected to prevent short circuits.

To avoid possible injury or equipment damage when replacing bulbs, observe any instructions provided by the bulb manufacturer. ◀



Do not touch the bulbs

Do not touch the glass of new bulbs with your bare hands, as even minute amounts of contamination will burn into the bulb's surface and reduce its service life.

Use a clean tissue, cloth or something similar, or hold the bulb by its base. ◀

### Light-emitting diodes (LEDs)

Light-emitting diodes installed behind a cover serve as the light source for controls, display elements and other equipment.

These light-emitting diodes, which are related to conventional lasers, are officially designated as Class 1 light-emitting diodes.



Do not remove the covers

Do not remove the covers, and never stare into the unfiltered light for several hours; otherwise, irritation of the retina could result. ◀

### Headlamp glass

Condensation can form on the inside of the external lamps in cool or humid weather. When the light is switched on, the condensation evaporates after a short time. The headlamp glasses do not need to be changed.

If there is a large amount of moisture, e.g., water droplets form in the lamp, have it checked by your service center.

### Front lamps, bulb replacement

#### At a glance

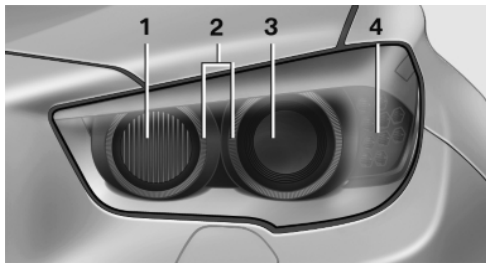

- 1 Adaptive light control
- 2 Parking lamp, daytime running lights\*

3 Low beams/high beams

4 Turn signal

### Xenon lamps\*

Because of the long life of these bulbs, the likelihood of failure is very low. Switching the lamps on and off frequently shortens their life.

If a xenon bulb fails, switch on the front fog lamps and continue the trip with great care. Comply with local regulations.



Do not perform work/bulb replacement on xenon headlamps

Have any work on the xenon lighting system, including bulb replacement, performed only by a service center.

Due to the high voltage present in the system, there is the danger of fatal injuries if work is carried out improperly. ◀

For checking and adjusting headlamp aim, please contact your BMW center.

### Turn signals, incl. side indicators

Follow the general instructions on lamps and bulbs, refer to page 258.

These lamps are made using LED technology.

Please contact your service center in the event of a malfunction.

### Adaptive light control

Follow the general instructions on lamps and bulbs, refer to page 258.

The illustration shows the left side of the engine compartment.

55-watt bulb, H3.

1. Open the folding cover in the engine compartment.



2. Turn the cap and remove it.

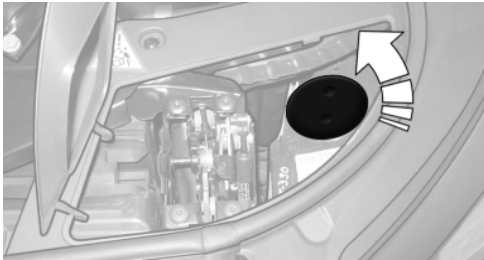

3. Unscrew the bulb holder counterclockwise.



4. Remove the bulb and replace it.
5. Insert the new bulb and attach the cover in the reverse order.

## Parking lamps

Follow the general instructions on lamps and bulbs, refer to page 258.

These lamps are made using LED technology. Please contact your service center in the event of a malfunction.

## Front fog lamps

Follow the general instructions on lamps and bulbs, refer to page 258.

35-watt bulb, H8.

1. Carefully pull out the grill toward the front.

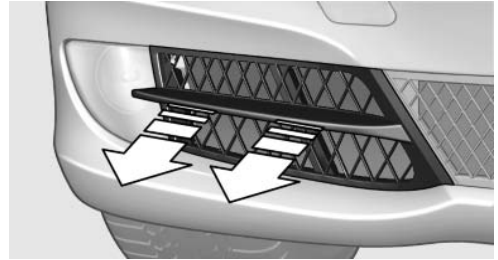

2. Remove the screws.

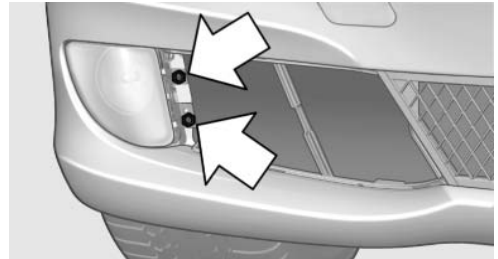

3. Pull the lamp out toward the front.
4. Remove the bulb and replace it.
5. Insert the new bulb and attach the cover in the reverse order.

## Tail lamps, bulb replacement

### At a glance

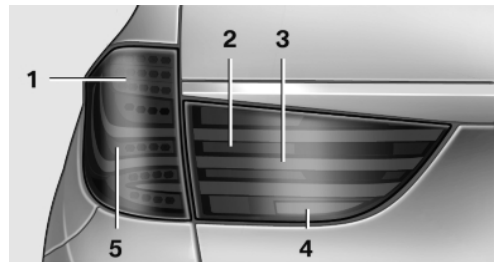

- 1 Turn signal
- 2 Tail lamp



- 3 Inside brake lamp\*
- 4 Backup lamp
- 5 Outside brake lamp

### Turn signal, brake, tail, and license plate lamps

Follow the general instructions on lamps and bulbs., refer to page [258](#)

These lights are made using LED technology. Contact your service center in the event of a malfunction.

### Lamps in the tailgate

Follow the general instructions on lamps and bulbs., refer to page [258](#)

### Access to the lamps

1. Remove the four screws using the screw driver from the tool kit.

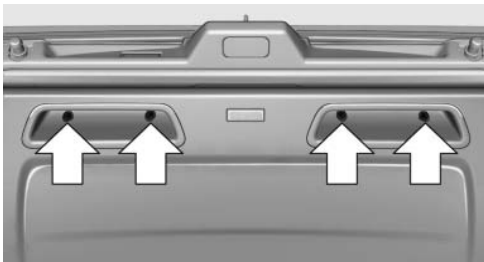

2. Pull down the cover with a firm tug.



3. Pull off the connector toward the left.

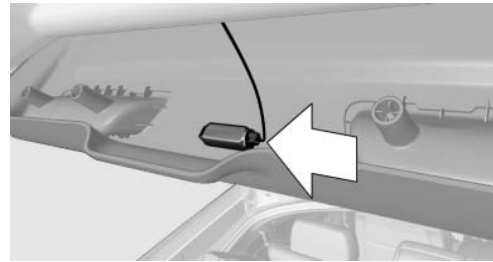

4. Replace the bulb.

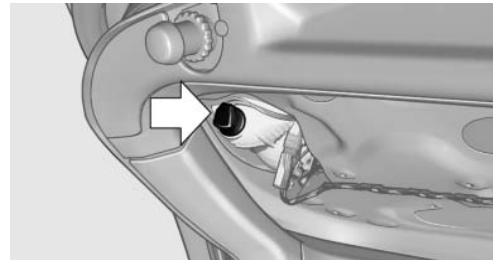

### Inside brake lamp\*

To change the brake lamp, contact your service center.

### Backup lamp

16-watt bulb, W16W.

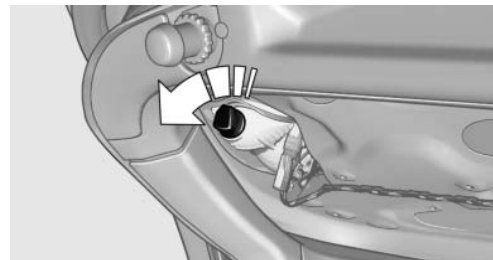

Turn the bulb, pull it out, and replace it.

## Changing wheels

### Notes

The vehicle equipment does not include a spare tire.

When using run-flat tires\* or tire sealants, a tire does not need to be changed immediately in the event of pressure loss due to a flat tire.

The tools for changing wheels are available as accessories from your service center.

## Jacking points for the vehicle jack

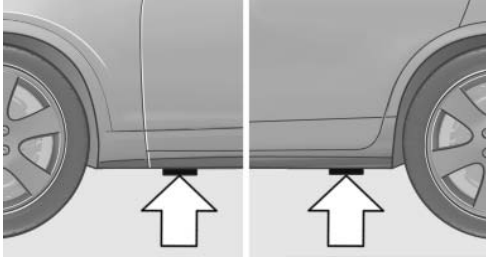

The jacking points for the vehicle jack are located in the positions shown.

## Lug bolt lock\*

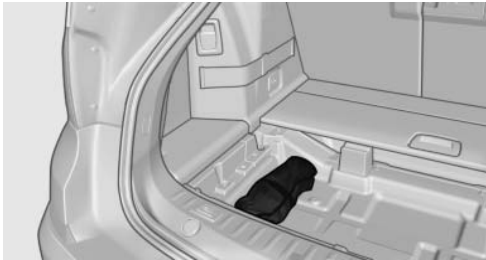

The lug bolt lock is in the tool kit or in a storage compartment close to the tool kit.

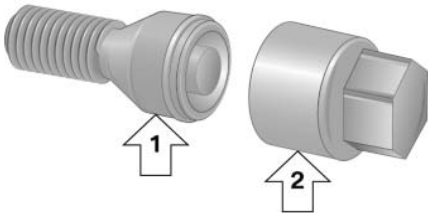

- ▷ Lug bolt, arrow 1.
- ▷ Adapter, arrow 2.

## Removing

1. Attach the adapter to the wheel lug.
2. Unscrew the lug bolt.

Remove the adapter after screwing the lug bolt back on.

## Vehicle battery

### Maintenance

The battery is maintenance-free, i.e., the electrolyte will last for the life of the battery.

Your service center will be glad to advise you on questions regarding the battery.

### Battery replacement



Use approved vehicle batteries only.

Only use vehicle batteries that have been approved for your vehicle by the manufacturer; otherwise, the vehicle could be damaged and systems or functions may not be fully available. ◀

After a battery replacement, have the battery registered on the vehicle by your service center to ensure that all comfort functions are fully available.

### Charging the battery

In the vehicle, only charge the battery via the terminals, refer to page 266, in the engine compartment with the engine off.

### Power failure

After a temporary power loss, some equipment needs to be reinitialized.

Individual settings need to be reprogrammed:

- ▷ Seat, mirror, and steering wheel memory: store the positions again.
- ▷ Time: update.
- ▷ Date: update.
- ▷ Radio station: save again.
- ▷ Navigation system: wait for the operability of the navigation.

## Disposing of old batteries



Have old batteries disposed of by your service center or bring them to a recycling center.

Maintain the battery in an upright position for transport and storage. Secure the battery so that it does not tip over during transport.

## Fuses

### Notes



Replacing fuses

Never attempt to repair a blown fuse and do not replace a defective fuse with a substitute of another color or amperage rating; this could lead to a circuit overload, ultimately resulting in a fire in the vehicle. ◀

Plastic tweezers and information on the fuse types and locations are stored in the fuse box in the cargo area.

### In the glove compartment

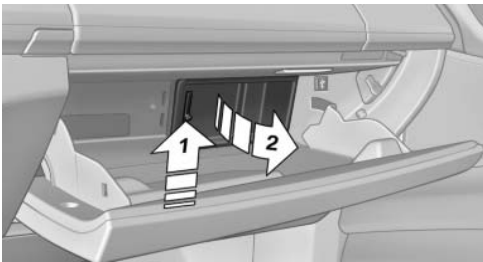

Push the handle up, arrow 1, and open the lid, arrow 2.

### In the cargo area

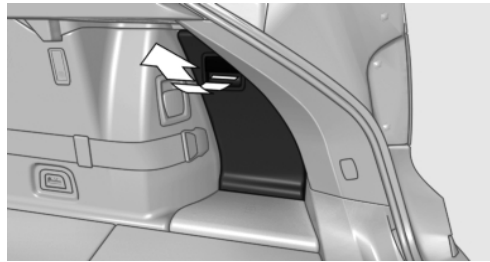

Open the cover on the right side trim.

Information on the fuse types and locations is found on a separate sheet.

# Breakdown assistance

## Hazard warning flashers

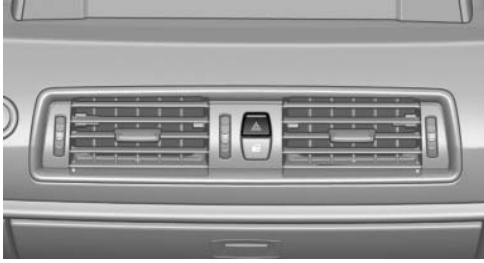

The button is located in the center console.

## Emergency Request\*

### Requirements

- ▷ Equipment version with full preparation package mobile phone.  
An Emergency Request can be made, even if no mobile phones are paired with the vehicle.
- ▷ BMW Assist is activated.
- ▷ The radio ready state is switched on.
- ▷ The BMW Assist system is logged in to a wireless communications network supported by BMW Assist.
- ▷ The Assist system is functional.

Only press the SOS button in an emergency.



Emergency Request not guaranteed

For technical reasons, the Emergency Request cannot be guaranteed under unfavorable conditions. ◀

### Service contract

- ▷ After your contract with BMW Assist has expired, the BMW Assist system can be deactivated by the service center without you having to visit a workshop.  
After deactivation, an Emergency Request is no longer possible.

- ▷ Under certain circumstances, the system can be reactivated by a service center after you sign a new contract.

## Initiating an Emergency Request



1. Press the cover briefly to open it.
  2. Press the SOS button until the LED in the button lights up.
- ▷ The LED lights up: an Emergency Request was initiated.  
If the situation allows, wait in your vehicle until the voice connection has been established.
  - ▷ The LED flashes if the connection to the BMW Assist Response Center has been established.

After the Emergency Request arrives at the BMW Assist Response Center, the BMW Assist Response Center contacts you and takes further steps to help you.

Even if you are unable to respond, the BMW Assist Response Center can take further steps to help you under certain circumstances.

For this purpose, data that are used to determine the necessary rescue measures, such as the current position of the vehicle if it can be established, are transmitted to the BMW Assist Response Center.

- ▷ If the LED is flashing but the BMW Assist Response Center cannot be heard on the hands-free system, the hands-free system may be malfunctioning. However, the BMW

Assist Response Center may still be able to hear you.

## Initiating an Emergency Request automatically

Under certain conditions, an Emergency Request is automatically initiated immediately after a severe accident. Automatic Collision Notification is not affected by pressing the SOS button.

## Warning triangle\*

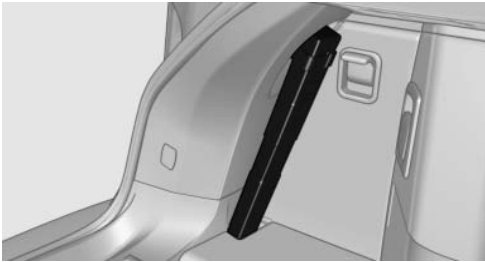

The warning triangle is located on the left in the cargo area.

Release the Velcro® fastener to remove it.

## First aid kit\*

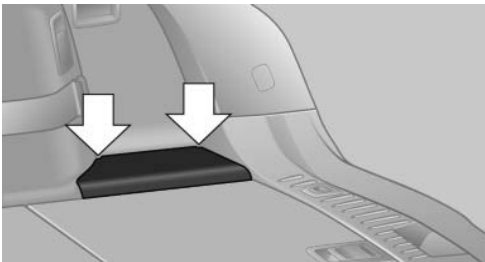

The first aid kit is located in a storage compartment on the right side in the cargo area.

To remove it, raise the cover by the corner, see arrow.

Some of the articles have a limited service life. Check the expiration dates of the contents regularly and replace any items promptly.

# Roadside Assistance

## Service availability

Roadside Assistance can be reached around the clock in many countries. You can obtain assistance there in the event of a vehicle breakdown.

## Roadside Assistance

The Roadside Assistance, refer to page 233 phone number can be viewed on the iDrive or a connection to Roadside Assistance\* can be established directly.

## Jump starting

### Notes

If the battery is discharged, an engine can be started using the battery of another vehicle and two jumper cables. Only use jumper cables with fully insulated clamp handles.

To prevent personal injury or damage to both vehicles, adhere strictly to the following procedure.



Do not touch live parts

To avoid the risk of potentially fatal injury, always avoid all contact with electrical components while the engine is running. ◀

## Preparation

1. Check whether the battery of the other vehicle has a voltage of 12 volts. This information can be found on the battery.
2. Switch off the engine of the assisting vehicle.
3. Switch off any electronic systems/power consumers in both vehicles.



Bodywork contact between vehicles

Make sure that there is no contact between the bodywork of the two vehicles; otherwise, there is the danger of short circuits. ◀

## Starting aid terminals



Connecting order

Connect the jumper cables in the correct order; otherwise, there is the danger of injury from sparking. ◀

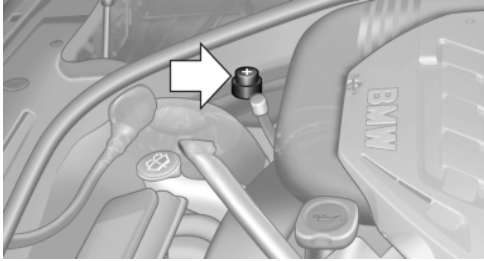

The so-called starting aid terminal in the engine compartment acts as the battery's positive terminal.

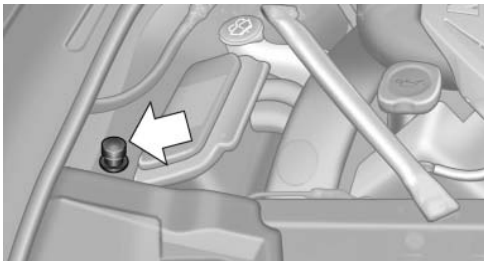

The body ground or a special nut acts as the negative terminal.

## Connecting the cables

1. Pull off the cap of the BMW starting aid terminal.
2. Attach one terminal clamp of the positive jumper cable to the positive terminal of the battery, or to the corresponding starting aid terminal of the vehicle providing assistance.
3. Attach the other end of the cable to the positive terminal of the battery, or to the corresponding starting aid terminal of the vehicle to be started.
4. Attach one terminal clamp of the negative jumper cable to the negative terminal of the battery, or to the corresponding engine or

body ground of the vehicle providing assistance.

5. Attach the other end of the cable to the negative terminal of the battery, or to the corresponding engine or body ground of the vehicle to be started.

## Starting the engine

Never use spray fluids to start the engine.

1. Start the engine of the assisting vehicle and let it run for several minutes at an increased idle speed.

If the vehicle being started has a diesel engine: let the engine of the assisting vehicle run for approx. 10 minutes.

2. Start the engine of the vehicle being started in the usual way.

If the first starting attempt is not successful, wait a few minutes before making another attempt in order to allow the discharged battery to recharge.

3. Let both engines run for several minutes.
4. Disconnect the jumper cables in the reverse order.

Check the battery and recharge if necessary.

## Tow-starting and towing

### Transporting your vehicle

#### Note

Your vehicle is not permitted to be towed. Therefore, contact a service center in the event of a breakdown.



Do not have the vehicle towed

Have your vehicle transported on a loading platform only; otherwise, damage may occur. ◀

## Tow truck

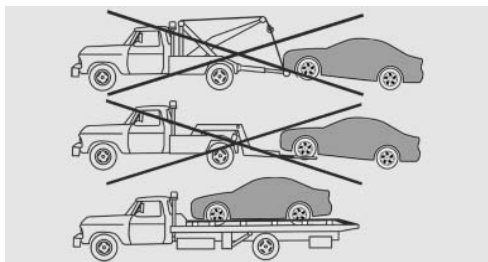

Do not lift the vehicle

Do not lift the vehicle by the tow fitting or body and chassis parts; otherwise, damage may result. ◀

## Tow-starting

### Note

Do not tow-start the vehicle.

Due to the automatic transmission, the engine cannot be started by tow-starting.

Have the cause of the starting difficulties remedied.

## Towing other vehicles

### General information



Light towing vehicle

Your vehicle must not be lighter than the vehicle being towed; otherwise, it will not be possible to control vehicle response. ◀



Attaching the tow bar/tow rope correctly

Attach the tow bar or tow rope to the tow fitting; connecting it to other vehicle parts may cause damage. ◀

- ▶ Switch on the hazard warning system, depending on local regulations.
- ▶ If the electrical system has failed, clearly identify the vehicle being towed by placing a sign or a warning triangle in the rear window.

## Towing methods when towing other vehicles

### Tow bar

The tow fittings used should be on the same side on both vehicles.

Should it prove impossible to avoid mounting the tow bar at an offset angle, please observe the following:

- ▶ Maneuvering capability is limited during cornering.
- ▶ The tow bar will generate lateral forces if it is secured with an offset.

### Tow rope

When starting to tow the vehicle, make sure that the tow rope is taut.

To avoid jerking and the associated stresses on the vehicle components when towing, always use nylon ropes or nylon straps.



Attaching the tow rope correctly

Only secure the tow rope on the tow fitting; otherwise, damage can occur when it is secured on other parts of the vehicle. ◀

### Tow fitting

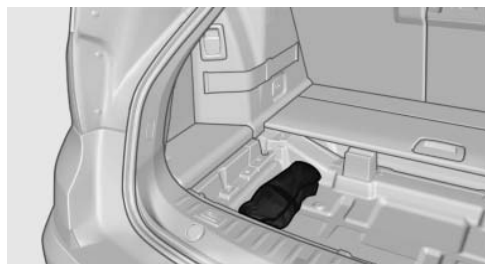

The screw-in tow fitting should always be carried in the vehicle. It can be screwed in at the front or rear of the BMW. It is located in the tool kit under the cargo area floor.



Tow fitting, information on use

- ▶ Use only the tow fitting provided with the vehicle and screw it all the way in.

- ▷ Use the tow fitting for towing on paved roads only.
- ▷ Use the tow fitting screwed in at the front for maneuvering the vehicle only.
- ▷ Avoid lateral loading of the tow fitting, e.g., do not lift the vehicle by the tow fitting.

Otherwise, damage to the tow fitting and the vehicle can occur. ◀

## Screw thread



Push out the cover by pressing on the top edge.



## Car washes

### Notes

 Steam jets or high-pressure washers  
When using steam jets or high-pressure washers, hold them a sufficient distance away and use a maximum temperature of 140 °F/ 60 °C.

Holding them too close or using excessively high pressures or temperatures can cause damage or preliminary damage that may then lead to long-term damage.

Follow the operating instructions for the high-pressure washer. ◀

 Cleaning sensors/cameras with high-pressure washers

When using high-pressure washers, do not spray the exterior sensors and cameras, e.g., Park Distance Control\*, for extended periods of time and only from a distance of at least 12 in/ 30 cm. ◀

Wash your vehicle frequently, particularly in winter.

Intense soiling and road salt can damage the vehicle.

### Washing in automatic car washes

Your vehicle can be washed in automatic car washes right from the start.

Give preference to cloth car washes or those that use soft brushes in order to avoid paint damage.

### Notes

Note the following:

- ▶ Make sure that the wheels and tires are not damaged by the transport mechanisms.
- ▶ Fold in the exterior mirrors; otherwise, they may be damaged, depending on the width of the vehicle.

- ▶ Deactivate the rain sensor, refer to page 72, to avoid unintentional wiper activation.
- ▶ In some cases, an unintentional alarm can be triggered by the interior motion sensor of the alarm system\*. Follow the instructions on avoiding an unintentional alarm, refer to page 45.

 Guide rails in car washes  
Avoid car washes with guide rails higher than 4 in/10 cm; otherwise, the vehicle body could be damaged. ◀

### Before driving into a car wash

The vehicle is able to roll when the following steps are taken:

1. Depress the brake pedal.
2. Engage transmission position N.
3. Release the parking brake, refer to page 67, or deactivate Automatic Hold, refer to page 69.
4. Switch the engine off.

 Transmission position P with the ignition off

When the ignition is switched off, position P is engaged automatically. When in an automatic car wash, for example, ensure that the ignition is not switched off accidentally. ◀

The vehicle cannot be locked from the outside when in transmission position N.

A signal is sounded when an attempt is made to lock the vehicle.

### Transmission position

Transmission position P is engaged automatically:

- ▶ When the ignition is switched off.
- ▶ After approx. 15 minutes.

## Headlamps

- ▷ Do not rub dry and do not use abrasive or caustic cleansers.
- ▷ Soak areas that have been soiled e.g. due to insects, with shampoo and wash off with water.
- ▷ Thaw ice with de-icing spray; do not use an ice scraper.

## After washing the vehicle

After washing the vehicle, apply the brakes briefly to dry them; otherwise, braking action can be reduced and corrosion of the brake discs can occur.

## Vehicle care

### Car care products

BMW recommends using cleaning and care products from BMW, since these have been tested and approved.



Car care and cleaning products

Follow the instructions on the container.

When cleaning the interior, open the doors or windows.

Only use products intended for cleaning vehicles.

Cleansers can contain substances that are dangerous and harmful to your health. ◀

### Vehicle paint

Regular care contributes to driving safety and value retention.

Environmental influences can act on the vehicle paint. Tailor the frequency and extent of your car care to these influences.

### Leather care

Remove dust from the leather often, using a cloth or vacuum cleaner.

Otherwise, particles of dust and road grime chafe in pores and folds, and lead to increased

wear and premature degradation of the leather surface.

To guard against discoloration, such as from clothing, provide leather care roughly every two months.

Clean light-colored leather more frequently as dust and dirt are more noticeable.

Use leather care products; otherwise, dirt and grease will gradually break down the protective layer of the leather surface.

Suitable care products are available from the service center.

### Upholstery material care

Vacuum regularly with a vacuum cleaner.

If they are very dirty, e.g., beverage stains, use a soft sponge or microfiber cloth with a suitable interior cleaner.

Clean the upholstery down to the seams using large sweeping motions. Avoid rubbing the material vigorously.



Damage from Velcro® fasteners

Open Velcro® fasteners on pants or other articles of clothing can damage the seat covers. Ensure that any Velcro® fasteners are closed. ◀

### Caring for special components

#### Light-alloy wheels

Use wheel cleaner, particularly during the winter months. Do not use aggressive, acidic, strongly alkaline or abrasive cleaners, or steam jets above 140 °F/60 °C; follow the manufacturer's instructions.

#### Chrome surfaces\*

Carefully clean components such as the radiator grille or door handles with an ample supply of water, possibly with shampoo added, particularly when they have been exposed to road salt.

#### Rubber components

Aside from water, treat only with rubber cleansers.

When cleaning rubber seals, do not use any silicon-containing car care products in order to avoid damage or reduced noise damping.

### Fine wood parts\*

Clean fine wood facing and fine wood components only with a moist rag. Then dry with a soft cloth.

### Plastic components

These include:

- ▷ Imitation leather surfaces.
- ▷ Headliner.
- ▷ Lamp lenses.
- ▷ Instrument cluster cover.
- ▷ Matte black spray-coated components.

Clean with a microfiber cloth.

Moisten the cloth lightly and use plastic cleanser, if necessary.

Do not soak the headliner.

 Do not use cleansers that contain alcohol or solvents

Do not use cleansers that contain alcohol or solvents, such as lacquer thinners, heavy-duty grease removers, fuel, or such; this could lead to surface damage. ◀

### Safety belts

Dirty belt straps impede the reeling action and thus have a negative impact on safety.

 **Chemical cleaning**  
Do not clean chemically; this can destroy the webbing. ◀

Use only a mild soapy solution, with the safety belts clipped into their buckles.

Do not allow the reels to retract the safety belts until they are dry.

### Floor carpets and floor mats\*

 No objects in the area around the pedals  
Keep floor mats, carpets, and any other objects out of the area of motion of the pedals; otherwise, the function of the pedals could be impeded while driving

Do not place additional floor mats over existing mats or other objects.

Only use floor mats that have been approved for the vehicle and can be properly fixed in place.

Ensure that the floor mats are securely fastened again after they were removed for cleaning, for example. ◀

Floor mats can be removed from the passenger compartment for cleaning.

If the floor carpets are very dirty, clean with a microfiber cloth and water or a textile cleaner. To prevent matting of the carpet, rub back and forth in the direction of travel only.

### Sensors/cameras

To clean sensors and cameras, use a cloth moistened with a small amount of glass cleaner.

### Displays/screens

Clean the displays with a microfiber cloth.

 **Cleaning displays**  
Do not use chemical or household cleansers.

Keep all fluids and moisture away from the unit. Otherwise, they could affect or damage surfaces or electrical components.

Avoid pressing too hard when cleaning and do not use abrasive materials; otherwise, damage can result. ◀

### Long-term vehicle storage

Your service center can advise you on what to consider when storing the vehicle for longer than three months.



## Reference

This chapter contains technical data, short commands for the voice activation system, and an index that will quickly take you to the information you need.

# Technical data

## Dimensions

Width with mirrors, height with roof-mounted aerial

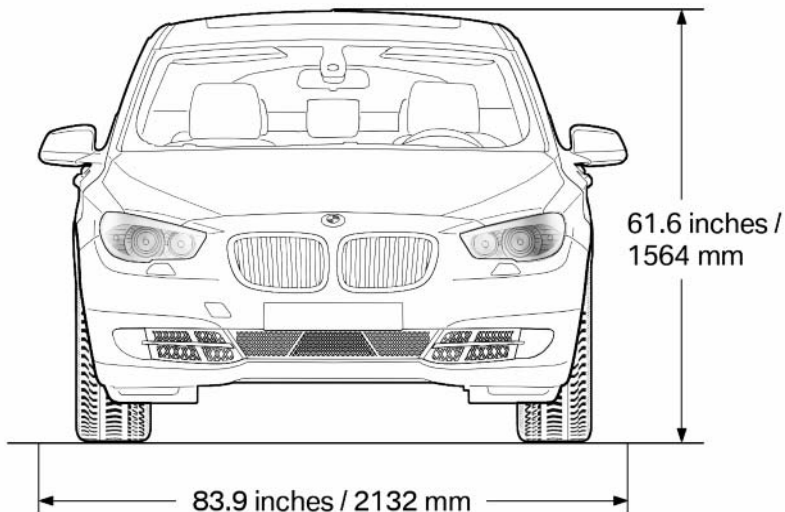

Width without mirrors

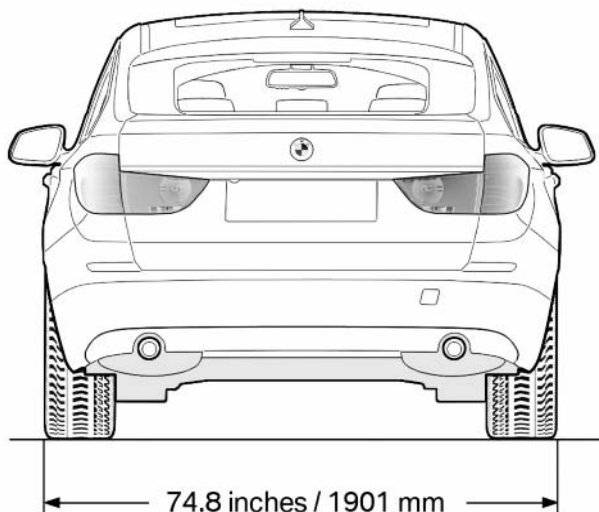

## Length, wheel base

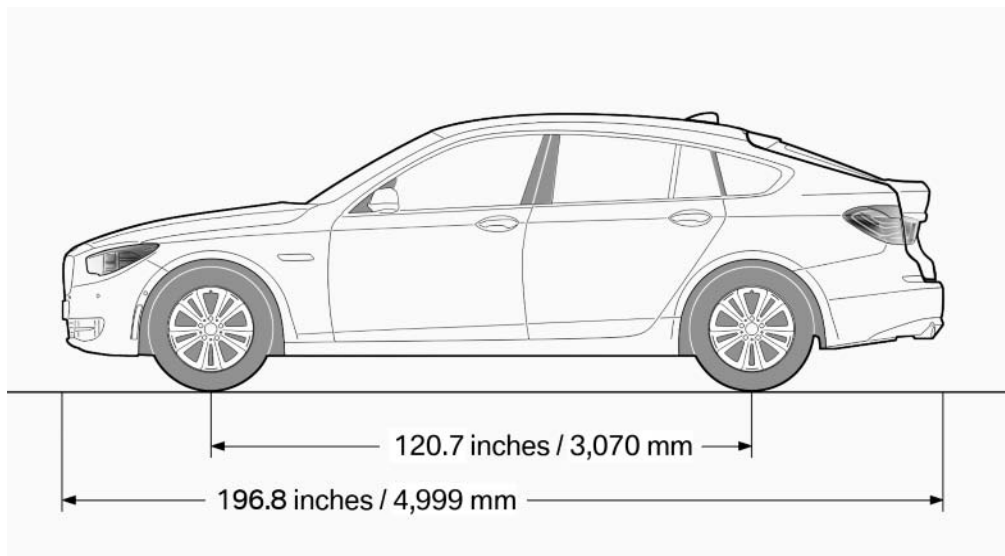

## Smallest turning circle

Ø: 40 ft/12.2 m

xDrive Ø: 41 ft/12.5 m

## Weights

535i		
Approved gross vehicle weight	lbs/kg	5,754/2,610
Load	lbs/kg	1,014/460
Approved front axle load	lbs/kg	2,667/1,210
Approved rear axle load	lbs/kg	3,306/1,500
Approved roof load capacity	lbs/kg	165/75
Cargo area capacity	cu ft/l	15.5-60/440-1,700
550i		
Approved gross vehicle weight	lbs/kg	5,952/2,700
Load	lbs/kg	970/440
Approved front axle load	lbs/kg	2,843/1,290

550i

Approved rear axle load	lbs/kg	3,306/1,500
Approved roof load capacity	lbs/kg	165/75
Cargo area capacity	cu ft/l	15.5-60/440-1,700

535i xDrive

Approved gross vehicle weight	lbs/kg	5,897/2,675
Load	lbs/kg	1,014/460
Approved front axle load	lbs/kg	2,777/1,260
Approved rear axle load	lbs/kg	3,306/1,500
Approved roof load capacity	lbs/kg	165/75
Cargo area capacity	cu ft/l	15.5-60/440-1,700

550i xDrive

Approved gross vehicle weight	lbs/kg	6,095/2,765
Load	lbs/kg	970/440
Approved front axle load	lbs/kg	2,976/1,350
Approved rear axle load	lbs/kg	3,306/1,500
Approved roof load capacity	lbs/kg	165/75
Cargo area capacity	cu ft/l	15.5-60/440-1,700

## Capacities

			Notes
Fuel tank	US gal/liters	approx. 18.5/70	Fuel quality, refer to page <a href="#">242</a>
Windshield and headlamp washer system	US quarts/liters	approx. 5.3/5.0	



# Short commands of the voice activation system\*

## General information

Instructions for voice activation system, refer to page [25](#).

To have the available spoken instructions read out loud: ›Voice commands‹

## Adjusting

### Vehicle

Function	Command
Open the main menu.	›Main menu‹
Open the options.	›Options‹
Open the settings.	›Settings‹
Info display of the instrument cluster.	›Info Display‹
Settings on the Control Display.	›Control display‹
Open the time and date.	›Time and date‹
Open the language and units.	›Language and units‹
Open the speed limit.	›Speed‹
Open the light.	›Lighting‹
Open the door lock.	›Door locks‹
Open the profiles.	›Profiles‹

### Equipment\*

Function	Command
Open the air conditioning settings.	›Climate‹
Open the Head-up Display.	›head up display‹
Enable the rear.	›Allow rear control‹

## Vehicle information

### Owner's Manual

Function	Command
Open the Owner's Manual.	›Display Owner's Manual‹
Open the Quick Reference Guide.	›Quick reference‹
Open the index.	›Owner's Manual‹
Open the search by pictures.	›Search by pictures‹

### Computer

Function	Command
Open the computer.	›Onboard info‹
Open the trip computer.	›Trip computer‹

### Vehicle

Function	Command
Open the vehicle information.	›Vehicle info‹
Open the vehicle status.	›Vehicle status‹

## Navigation\*

### General information

Function	Command
Navigation menu.	›Navigation‹
Open the destination entry.	›Enter address‹
Enter the address.	›Enter address‹
Open destination guidance.	›Guidance‹
Start destination guidance.	›Start guidance‹
Terminate destination guidance.	›Stop guidance‹
Open the home address.	›Home address‹
Open the route criteria.	›Route preference‹

Function	Command
Open the route.	›Route information‹
Switch on the spoken instruction.	›Switch on voice instructions‹
Repeat the spoken instruction.	›Repeat voice instructions‹
Switch off the spoken instruction.	›Switch off voice instructions‹
Display the address book.	›Address book‹
Display the most recent destinations.	›Last destinations‹
Open the traffic bulletins.	›Traffic Info‹
Special destinations.	›Points of interest‹

## Map

Function	Command
Display the map.	›Map‹
Map facing north.	›Map facing north‹
Map facing the direction of travel.	›Map in direction of travel‹
Perspective map.	›Map perspective view‹
Automatic scaling of the map.	›Map with automatic scaling‹
Scale...feet.	›Map scale ... feet‹
Scale...meters.	›Map scale ... meters‹ e.g., map scale 100 meters
Scale...kilometers.	›Map scale ... kilometers‹ e.g., map scale 5 kilometers
Scale...miles.	›Map scale ... miles‹ e.g., map scale 5 miles

## Split screen settings

Function	Command
Split screen.	›Switch on splitscreen‹
Switch off the split screen.	›Turn off split screen‹
Adjust the split screen.	›Split screen content‹
Split screen, map facing north.	›Split screen map facing north‹
Split screen, current position.	›Split screen current position‹

Function	Command
Split screen, facing the direction of travel.	›Split screen map in direction of travel‹
Split screen, perspective.	›Split screen perspective‹
Split screen, expanded intersection zoom.	›Splitscreen Exit ramp view‹
Split screen scale...feet.	›Split screen scale ... feet‹ e.g., split screen scale 100 feet
Split screen scale...meters.	›Split screen scale ... meters‹ e.g., split screen scale 100 meters
Split screen scale...kilometers.	›Split screen scale ... kilometers‹ e.g., split screen scale 5 kilometers
Split screen scale...miles.	›Split screen scale ... miles‹ e.g., split screen scale 5 miles
Split screen, highlight the traffic situation.	›Split screen, Traffic conditions‹
Split screen, computer.	›Split screen on board info‹
Split screen, trip computer.	›Splitscreen trip computer‹
Split screen, scale automatically.	›Split screen automatic scaling‹

### Destination guidance with intermediate destinations

Function	Command
Enter a new destination.	›Enter address‹
Trip list.	›Stored trips‹

## Radio

### FM

Function	Command
Open a frequency.	›Frequency ... megahertz‹ e.g., 93.5 megahertz or frequency 93.5
Open the radio.	›Radio‹
Open the FM stations.	›F M‹
Open the manual search.	›Manuak‹

Function	Command
Select a frequency range.	›Select frequency‹
Open a station.	›Select station‹

## AM

Function	Command
Open a frequency.	›Frequency ... Kilohertz‹ e.g., frequency 753 or 753 kilohertz
Open the AM stations.	›A M‹
Open the manual search.	›Manual‹

## Weather Band

Function	Command
Open the Weather Band.	›Weather band‹
Switch on the Weather Band.	›Weather band on‹
Select a Weather Band station.	›Select a weather channel‹

## Satellite radio\*

Function	Command
Open the satellite radio.	›Satellite radio‹
Switch on the satellite radio.	›Satellite radio on‹
Select a satellite radio channel.	›Select satellite radio‹ e.g., satellite radio channel 2

## Stored stations

Function	Command
Open the stored stations.	›Presets‹
Choose a stored station.	›Select preset‹
Select a stored station.	›Preset ...‹ e.g., stored station 2

## CD/Multimedia\*

### CD/DVD drive

Function	Command
Select a track.	›Track ...‹ e.g., track 5 or ›C D track ...‹ e.g., CD track 5
Play back a CD.	›C D on‹
Select a CD.	›Select C D‹
Select a CD and track.	›C D ... track ...‹ e.g., CD 3 track 5
Open the CD and Multimedia menu.	›C D and multimedia‹
CD and DVD.	›C D‹
Select a DVD.	›D V D ...‹ e.g. DVD 3
Display the entertainment details on a split screen.	›Entertainment details‹

### Music collection

Function	Command
Search for music, open a menu.	›Music search‹
Open the current playback.	›Current playback‹
Open the music collection.	›Music collection‹
Play back the music collection.	›Music collection on‹
Play back the most frequently played tracks.	›Top fifty‹

### External devices

Function	Command
Open the external devices.	›External devices‹
Open the Bluetooth devices.	›Bluetooth‹
AUX at front.	›AUX front‹

## Tone

Function	Command
Open the tone settings.	›Tone‹

## Telephone\*

Function	Command
Dial a phone number.	›Dial number‹
Open the Telephone menu.	›Telephone‹
Display the phone book.	›Phonebook‹
Redialing.	›Redial‹
Display received calls.	›Received calls‹
List of messages	›Messages‹
Open the Bluetooth devices.	›Bluetooth‹

## Office\*

Function	Command
Open the Office menu.	›Office‹
Display Office Today.	›Current office‹
Display the contacts.	›Contacts‹
Display the messages.	›Messages‹
Display the calendar.	›Calendar‹
Display the tasks.	›Tasks‹
Display the reminders.	›Reminders‹

## Contacts\*

Function	Command
Select a name.	›Choose name‹
My contacts.	›My contacts‹
Open the contacts.	›Contacts‹
New contact.	›New contact‹

## BMW ConnectedDrive\*

Function	Command
Open BMW ConnectedDrive.	›Connected Drive‹
Open BMW Search.	›B M W Online‹





# Everything from A to Z

## Index

### A

ABS, Antilock Brake System [99](#)  
 ACC, Active Cruise Control with Stop & Go [106](#)  
 Activated-charcoal filter [130](#)  
 Active Blind Spot Detection [96](#)  
 Active Cruise Control with Stop & Go, ACC [106](#)  
 Active seat, front [52](#)  
 Active seat ventilation, front [52](#)  
 Active seat ventilation, rear [55](#)  
 Active Steering, integral [102](#)  
 Adaptive brake assistant [99](#)  
 Adaptive brake lights, refer to Brake force display [98](#)  
 Adaptive drive [101](#)  
 Adaptive light control [86](#)  
 Adaptive light control, bulb replacement [259](#)  
 Additional telephone [210](#)  
 Additives, oil [254](#)  
 Adjustments, seats/head restraints [49](#)  
 Airbags [89](#)  
 Airbags, indicator/warning light [90](#)  
 Air circulation, refer to Recirculated-air mode [128](#)  
 Air distribution, manual [127](#)  
 Air drying, refer to Cooling function [129](#)  
 Air pressure, tires [243](#)  
 Air vents, refer to Ventilation [130](#)  
 Air volume, automatic climate control [128](#)  
 Alarm system [44](#)  
 Alarm, unintentional [45](#)

All around the center console [17](#)  
 All around the headliner [18](#)  
 All around the steering wheel [12](#)  
 ALL program, automatic climate control [129](#)  
 All-season tires, refer to Winter tires [249](#)  
 All-wheel-drive [100](#)  
 Alternating-code hand-held transmitter [134](#)  
 Alternative oil types [254](#)  
 AM/FM station [174](#)  
 Announcement, navigation, refer to Spoken instructions [163](#)  
 Antifreeze, washer fluid [73](#)  
 Antilock Brake System, ABS [99](#)  
 Anti-slip control, refer to DSC [99](#)  
 Appointments [226](#)  
 Approved engine oils [254](#)  
 Apps [236](#)  
 Armrest, refer to Center armrest [140](#)  
 Arrival time [80](#)  
 Ashtray [135](#)  
 Assist [232](#)  
 Assistance, Roadside Assistance [265](#)  
 Assistance when driving off [99](#)  
 Audio playback [181](#)  
 Audio playback, Bluetooth [196](#)  
 AUTO intensity [128](#)  
 Automatic car wash [269](#)  
 Automatic climate control [127](#)  
 Automatic Cruise Control with Stop & Go [106](#)

Automatic Curb Monitor [60](#)  
 Automatic deactivation, front passenger airbags [90](#)  
 Automatic headlamp control [86](#)  
 Automatic Hold [69](#)  
 Automatic locking [39](#)  
 Automatic recirculated-air control [128](#)  
 Automatic Soft Closing, doors [39](#)  
 Automatic Soft Closing, tailgate [40](#)  
 Automatic transmission with Steptronic [73](#)  
 Automatic trunk lid [40](#)  
 AUTO program, automatic climate control [128](#)  
 AUTO program, intensity [128](#)  
 AUX-IN port [192](#)  
 Average fuel consumption [79](#)  
 Average speed [79](#)  
 Axle loads, weights [275](#)

### B

Backrest curvature, refer to Lumbar support [51](#)  
 Backrest, seats [49](#)  
 Backrest, width [51](#)  
 Back seats, adjusting [53](#)  
 Backup camera [119](#)  
 Backup lamps, bulb replacement [261](#)  
 Balance [172](#)  
 Band-Aids, refer to First aid kit [265](#)  
 Bar for tow-starting/towing [267](#)  
 Basic position, rear seats [54](#)  
 Bass [172](#)

Battery replacement, remote control, rear entertainment 202  
Battery replacement, vehicle battery 262  
Battery replacement, vehicle remote control 32  
Battery, vehicle 262  
Before entering the car wash 269  
Belts, safety belts 55  
Beverage holder, cupholder 141  
Blinds, sun protection 46  
Bluetooth audio 196  
BMW Apps 236  
BMW Apps, video playback 195  
BMW Assist 232  
BMW EfficientDynamics, refer to Saving fuel 150  
BMW homepage 6  
BMW Internet page 6  
BMW Maintenance System 256  
BMW Online 234  
Bottle holder, refer to Cupholder 141  
Brake assistant 99  
Brake assistant, adaptive 99  
Brake discs, breaking in 146  
Brake force display 98  
Brake lamps, brake force display 98  
Brake lamps, bulb replacement 261  
Brake lights, adaptive 98  
Brake pads, breaking in 146  
Braking, notes 147  
Breakdown assistance 264, 265  
Breaking in 146  
Brightness of Control Display 82  
Bulb replacement 258  
Bulb replacement, front 259  
Bulb replacement, rear 260  
Bulbs and lamps 258

Button, RES 108  
Button, Start/Stop 66  
Bypassing, refer to starting aid 265

## C

Calendar 226  
California Proposition 65 Warning 7  
Camera, backup camera 121  
Camera, care 271  
Camera, Side View 122  
Camera, Top View 119  
Can holder, refer to Cupholder 141  
Car battery 262  
Car care products 270  
Care, displays 271  
Care, vehicle 270  
Cargo 148  
Cargo area 136  
Cargo area, enlarging 136  
Cargo area lid 39  
Cargo area, storage compartments 142  
Cargo partition 138  
Cargo straps, securing cargo 149  
Car key, refer to Remote control 32  
Carpet, care 271  
Car wash 269  
Catalytic converter, refer to Hot exhaust system 146  
CBS Condition Based Service 256  
CD/DVD 181  
CD/DVD player, rear 201  
CDs, storing 188  
Cell phone 210  
Center armrest 140  
Center console 17  
Central locking system 35  
Central screen, refer to Control Display 19  
Changes, technical, refer to Safety 7

Changing parts 258  
Changing wheels/tires 248  
Check Control 83  
Children, seating position 62  
Children, transporting safely 62  
Child restraint fixing system 62  
Child restraint fixing system LATCH 63  
Child restraint fixing systems, mounting 62  
Child-safety locks 65  
Child seat, mounting 62  
Child seats 62  
Chrome parts, care 270  
Cigarette lighter 135  
Cleaning, displays 271  
Climate control 127  
Climate control windshield 147  
Clock 78  
Closing/opening from inside 38  
Closing/opening via door lock 38  
Closing/opening with remote control 36  
Clothes hooks 141  
Collision warning 112  
Combination instrument 14  
Combination instrument, electronic displays 16  
Combination switch, refer to Turn signals 71  
Combination switch, refer to Wiper system 71  
Comfort Access 42  
COMFORT program, Dynamic Driving Control 104  
Computer 78  
Concierge service 233  
Condensation on windows 128  
Condensation under the vehicle 148  
Condition Based Service CBS 256

Confirmation signal [37](#)  
 Contacts [221](#), [230](#)  
 Control Display [19](#)  
 Control Display, settings [81](#)  
 Controller [19](#)  
 Control systems, driving stability [99](#)  
 Convenient opening [36](#)  
 Coolant [254](#)  
 Coolant temperature [77](#)  
 Cooling function [129](#)  
 Cooling, maximum [128](#)  
 Cooling system [254](#)  
 Corrosion on brake discs [148](#)  
 Cruise control [113](#)  
 Cruise control, active with Stop & Go [106](#)  
 Cruising range [76](#)  
 Cupholder [141](#)  
 Curb weight [275](#)  
 Current fuel consumption [77](#)  
 Current location, storing [156](#)  
 Customer Relations [235](#)

## D

Damage, tires [247](#)  
 Damping control, dynamic [101](#)  
 Data, technical [274](#)  
 Date [78](#)  
 Daytime running lights [86](#)  
 Defrosting, refer to Windows, defrosting [128](#)  
 Destination distance [79](#)  
 Destination guidance [161](#)  
 Destination guidance with intermediate destinations [160](#)  
 Destination input, navigation [154](#)  
 Digital clock [78](#)  
 Digital radio [175](#)  
 Dimensions [274](#)  
 Dimmable interior rearview mirror [61](#)  
 Direction indicator, refer to Turn signals [71](#)

Display in front wind-shield [125](#)  
 Display, instrument cluster [76](#)  
 Display lighting, refer to Instrument lighting [88](#)  
 Displays [14](#)  
 Displays, cleaning [271](#)  
 Disposal, coolant [255](#)  
 Disposal, vehicle battery [263](#)  
 Distance control, refer to PDC [115](#)  
 Distance, selecting for ACC [107](#)  
 Distance to destination [79](#)  
 Divided screen view, split screen [23](#)  
 Door lock, refer to Remote control [32](#)  
 Doors, Automatic Soft Closing [39](#)  
 Downhill control [100](#)  
 Drive-off assistant [99](#)  
 Drive-off assistant, refer to DSC [99](#)  
 Driving instructions, breaking in [146](#)  
 Driving notes, general [146](#)  
 Driving stability control systems [99](#)  
 Driving tips [146](#)  
 DSC Dynamic Stability Control [99](#)  
 DTC Dynamic Traction Control [100](#)  
 DVD/CD [181](#)  
 DVD/CD notes [187](#)  
 DVD/CD player, rear [201](#)  
 DVD changer [185](#)  
 DVD settings [184](#)  
 DVDs, storing [188](#)  
 DVD, video [183](#)  
 Dynamic Damping Control [101](#)  
 Dynamic destination guidance [167](#)  
 Dynamic Drive [101](#)  
 Dynamic Driving Control [103](#)

Dynamic Stability Control DSC [99](#)  
 Dynamic Traction Control DTC [100](#)

## E

EfficientDynamics, refer to Saving fuel [150](#)  
 Electronic displays, instrument cluster [16](#)  
 Electronic engine oil level check [253](#)  
 Electronic Stability Program ESP, refer to DSC [99](#)  
 Emergency detection, remote control [33](#)  
 Emergency release, door lock [38](#)  
 Emergency release, fuel filler flap [240](#)  
 Emergency release, parking brake [68](#)  
 Emergency Request [264](#)  
 Emergency service, refer to Roadside Assistance [265](#)  
 Emergency start function, engine start [33](#)  
 Emergency unlocking, tailgate [42](#)  
 Energy Control [77](#)  
 Energy recovery [78](#)  
 Engine compartment [251](#)  
 Engine compartment, working in [251](#)  
 Engine coolant [254](#)  
 Engine oil [253](#)  
 Engine oil, adding [253](#)  
 Engine oil additives [254](#)  
 Engine oil filler neck [253](#)  
 Engine oil temperature [77](#)  
 Engine oil types, alternative [254](#)  
 Engine oil types, approved [254](#)  
 Engine start during malfunction [33](#)

Engine start, refer to Starting the engine [66](#)  
Engine start, Starting aid [265](#)  
Engine stop [67](#)  
Engine temperature [77](#)  
Equalizer [172](#)  
Equipment, interior [133](#)  
ESP Electronic Stability Program, refer to DSC [99](#)  
Exchanging wheels/tires [248](#)  
Exhaust system [146](#)  
Exterior mirror, automatic dimming feature, dimmable exterior mirrors [60](#)  
Exterior mirrors [59](#)  
External devices [192](#)  
External start [265](#)  
External temperature display [77](#)  
External temperature warning [77](#)  
Eyes for securing cargo [149](#)

## F

Fader [172](#)  
Failure message, refer to Check Control [83](#)  
False alarm, refer to Unintentional alarm [45](#)  
Fan, refer to Air volume [128](#)  
Fault displays, refer to Check Control [83](#)  
Filler neck for engine oil [253](#)  
Fine wood, care [271](#)  
First aid kit [265](#)  
Fitting for towing, refer to Tow fitting [267](#)  
Flat tire, Tire Pressure Monitor TPM [92](#)  
Flat tire, warning lamp [93](#)  
Flat tire, wheel change [261](#)  
Flooding [147](#)  
Floor carpet, care [271](#)  
Floor mats, care [271](#)  
FM/AM station [174](#)  
Fold-out position, windshield wipers [73](#)

Foot brake [147](#)  
Front airbags [89](#)  
Front fog lamps [88](#)  
Front fog lamps, front, bulb replacement [260](#)  
Front lamps [259](#)  
Front passenger airbags, automatic deactivation [90](#)  
Front passenger airbags, indicator lamp [91](#)  
Front seats, adjusting [49](#)  
Fuel cap [240](#)  
Fuel consumption, current [77](#)  
Fuel consumption, refer to Average fuel consumption [79](#)  
Fuel filler flap [240](#)  
Fuel gauge [76](#)  
Fuel quality [242](#)  
Fuel, tank capacity [276](#)  
Fuse [263](#)

## G

Garage door opener, refer to Integrated universal remote control [133](#)  
Gas station recommendation [163](#)  
Gear change, automatic transmission [74](#)  
General driving notes [146](#)  
Glass sunroof, refer to Panoramic glass sunroof [47](#)  
Glove compartment [139](#)  
GPS navigation, refer to Navigation system [154](#)  
Gross vehicle weight, approved [275](#)  
Gross weight, permissible for trailer towing [275](#)

## H

Hand brake, refer to Parking brake [67](#)  
Hand-held transmitter, alternating code [134](#)

Hazard warning flashers [264](#)  
HDC Hill Descent Control [100](#)  
HD Radio [175](#)  
Head airbags [89](#)  
Headlamp control, automatic [86](#)  
Headlamp courtesy delay feature [85](#)  
Headlamp courtesy delay feature via remote control [36](#)  
Headlamp flasher [71](#)  
Headlamp glass [259](#)  
Headlamps [259](#)  
Headlamps, care [270](#)  
Headlamp washer system [71](#)  
Headliner [18](#)  
Headphones, rear entertainment [205](#)  
Head restraints [49](#)  
Head restraints, front [56](#)  
Head restraints, rear [57](#)  
Head-up Display [125](#)  
Head-up Display, care [271](#)  
Heavy cargo, stowing [149](#)  
Height, seats [49](#)  
Height with roof-mounted aerial, vehicle [274](#)  
High-beam Assistant [87](#)  
High beams [71](#)  
High beams/low beams, refer to High-beam Assistant [87](#)  
Hill Descent Control HDC [100](#)  
Hills [148](#)  
Hill start assistant, refer to Drive-off assistant [99](#)  
Hints [6](#)  
Holder for beverages [141](#)  
Homepage [6](#)  
Hood [251](#)  
Horn [12](#)  
Hotel function, tailgate [42](#)  
Hot exhaust system [146](#)  
House number, entering for navigation [155](#)  
Hydroplaning [147](#)

- I**
- Ice warning, refer to External temperature warning [77](#)
  - Icy roads, refer to External temperature warning [77](#)
  - Identification marks, tires [246](#)
  - Identification number, refer to Engine compartment [251](#)
  - iDrive [19](#)
  - Ignition key, refer to Remote control [32](#)
  - Ignition off [66](#)
  - Ignition on [66](#)
  - Indication of a flat tire [93](#)
  - Indicator and warning messages [14](#)
  - Indicator lamps [14](#)
  - Individual air distribution [127](#)
  - Individual settings, refer to Personal Profile [33](#)
  - Inflation pressure, tires [243](#)
  - Info display, refer to Computer [78](#)
  - Information on the navigation data [168](#)
  - Initialization, Integral Active Steering [102](#)
  - Initializing, Tire Pressure Monitor TPM [93](#)
  - Instrument cluster [14, 76](#)
  - Instrument cluster, electronic displays [16](#)
  - Instrument lighting [88](#)
  - Integral Active Steering [102](#)
  - Integrated key [32](#)
  - Integrated universal remote control [133](#)
  - Intensity, AUTO program [128](#)
  - Interactive map [158](#)
  - Interior equipment [133](#)
  - Interior lamps [88](#)
  - Interior lamps via remote control [36](#)
  - Interior motion sensor [45](#)
  - Interior rearview mirror [60](#)
  - Interior rearview mirror, automatic dimming feature [61](#)
  - Intermediate destinations [160](#)
  - Internet page [6](#)
  - Intersection, entering for navigation [155](#)
  - Interval display, service requirements [82](#)
  - iPod/iPhone [193](#)
- J**
- Jacking points for the vehicle jack [262](#)
  - Jack, refer to Vehicle jack [262](#)
  - Joystick, automatic transmission [74](#)
- K**
- Key/remote control [32](#)
  - Keyless Go, refer to Comfort Access [42](#)
  - Key Memory, refer to Personal Profile [33](#)
  - Kickdown, automatic transmission [74](#)
  - Knee airbag [89](#)
- L**
- Lamp replacement [258](#)
  - Lamp replacement, front [259](#)
  - Lamp replacement, rear [260](#)
  - Lamps [85](#)
  - Lamps and bulbs [258](#)
  - Lane departure warning [95](#)
  - Lane margin, warning [95](#)
  - Language on Control Display [82](#)
  - Lashing eyes, securing cargo [149](#)
  - LATCH child restraint fixing system [63](#)
  - Leather, care [270](#)
  - LEDs, light-emitting diodes [259](#)
  - Length, vehicle [275](#)
  - Letters and numbers, entering [24](#)
  - License plate lamp, bulb replacement [261](#)
  - Light-alloy wheels, care [270](#)
  - Light control [86](#)
  - Light-emitting diodes, LEDs [259](#)
  - Lighter, front [135](#)
  - Lighting [85](#)
  - Lighting via remote control [36](#)
  - Light switch [85](#)
  - Load [149](#)
  - Loading [148](#)
  - Loading position [138](#)
  - Lock, door [38](#)
  - Locking/unlocking from inside [38](#)
  - Locking/unlocking via door lock [38](#)
  - Locking/unlocking with remote control [36](#)
  - Locking, automatic [39](#)
  - Locking, central [35](#)
  - Locking via tailgate [40](#)
  - Lock, power window [46](#)
  - Locks, doors, and windows [65](#)
  - Low beams [85](#)
  - Low beams, automatic, refer to High-beam Assistant [87](#)
  - Lower back support [51](#)
  - Lug bolt lock [262](#)
  - Luggage rack, refer to Roof-mounted luggage rack [149](#)
  - Lumbar support [51](#)
- M**
- Maintenance [256](#)
  - Maintenance requirements [256](#)
  - Maintenance, service requirements [82](#)
  - Maintenance System, BMW [256](#)
  - Malfunction displays, refer to Check Control [83](#)
  - Malfunction, self-leveling suspension [103](#)

Manual air distribution [127](#)  
Manual air volume [128](#)  
Manual brake, refer to Parking brake [67](#)  
Manual mode, transmission [75](#)  
Manual operation, backup camera [119](#)  
Manual operation, door lock [38](#)  
Manual operation, exterior mirrors [60](#)  
Manual operation, fuel filler flap [240](#)  
Manual operation, Park Distance Control PDC [116](#)  
Manual operation, parking brake [68](#)  
Manual operation, Side View [122](#)  
Manual operation, Top View [118](#)  
Map, destination entry [158](#)  
Map in split screen [165](#)  
Map view [163](#)  
Marking on approved tires [248](#)  
Marking, run-flat tires [249](#)  
Massage seat, front [52](#)  
Master key, refer to Remote control [32](#)  
Maximum cooling [128](#)  
Maximum speed, winter tires [249](#)  
Measure, units of [82](#)  
Medical kit [265](#)  
Memory for seat, mirrors, steering wheel [58](#)  
Menu in instrument cluster [78](#)  
Menus, operating, iDrive [19](#)  
Menus, refer to iDrive operating concept [20](#)  
Message list, traffic bulletins [165](#)  
Messages [224](#)  
Messages, refer to Check Control [83](#)  
Microfilter [130](#)

Minimum tread, tires [247](#)  
Mirror [59](#)  
Mirror memory [58](#)  
Mobile communication devices in the vehicle [147](#)  
Mobile phone [210](#)  
Modifications, technical, refer to Safety [7](#)  
Moisture in headlamp [259](#)  
Monitor, refer to Control Display [19](#)  
Mounting of child restraint fixing systems [62](#)  
MP3 player [192](#)  
Multi-function hook [142](#)  
Multifunction steering wheel, buttons [12](#)  
Multimedia [181](#)  
Music collection [188](#)  
Music search [189](#)  
Music, storing [188](#)

## N

Navigation [154](#)  
Navigation data [168](#)  
Neck restraints, front, refer to Head restraints [56](#)  
Neck restraints, rear, refer to Head restraints [57](#)  
New wheels and tires [248](#)  
Night Vision with pedestrian detection [122](#)  
NORMAL program, Dynamic Driving Control [104](#)  
Notes [227](#)  
Nylon rope for tow-starting/towing [267](#)

## O

OBD Onboard Diagnostics [256](#)  
Obstacle marking, backup camera [120](#)  
Odometer [78](#)  
Office [221](#)  
Oil [253](#)

Oil, adding [253](#)  
Oil additives [254](#)  
Oil change interval, service requirements [82](#)  
Oil filler neck [253](#)  
Oil level check [253](#)  
Oil types, alternative [254](#)  
Oil types, approved [254](#)  
Old batteries, disposal [263](#)  
Onboard Diagnostics OBD [256](#)  
Onboard monitor, refer to Control Display [19](#)  
Online, refer to BMW Online [234](#)  
Opening/closing from inside [38](#)  
Opening/closing via door lock [38](#)  
Opening/closing with remote control [36](#)  
Operating concept, iDrive [19](#)  
Outside air, refer to Automatic recirculated-air control [128](#)  
Overheating of engine, refer to Coolant temperature [77](#)

## P

Paint, vehicle [270](#)  
Panic mode [36](#)  
Panoramic glass sunroof [47](#)  
Park Distance Control PDC [115](#)  
Parked-car ventilation [132](#)  
Parked vehicle, condensation [148](#)  
Parking aid, refer to PDC [115](#)  
Parking brake [67](#)  
Parking lamps [85](#)  
Parking lamps, bulb replacement [260](#)  
Parking with Auto Hold [69](#)  
Passenger side mirror, tilting downward [60](#)  
Pathway lines, backup camera [120](#)

PDC Park Distance Control [115](#)  
 Pedestrian detection, refer to Night Vision [122](#)  
 People detection, refer to Night Vision [122](#)  
 Permissible axle load [275](#)  
 Personal information [221](#)  
 Personal Profile [33](#)  
 Phone [210](#)  
 Pinch protection system, glass sunroof [48](#)  
 Pinch protection system, windows [45](#)  
 Plastic, care [271](#)  
 PlugIn [237](#)  
 Position, storing [156](#)  
 Postal code, entering in navigation [154](#)  
 Power failure [262](#)  
 Power windows [45](#)  
 Pressure, tire air pressure [243](#)  
 Profile, refer to Personal Profile [33](#)  
 Programmable memory buttons, iDrive [23](#)  
 Protective function, glass sunroof [48](#)  
 Protective function, windows [45](#)  
 Push-and-turn switch, refer to Controller [19](#)

## R

Radiator fluid [254](#)  
 Radio [174](#)  
 Radio-operated key, refer to Remote control [32](#)  
 Radio ready state [66](#)  
 Rain sensor [72](#)  
 Random [182](#)  
 Random playback [182](#)  
 RDS [175](#)  
 Reading out loud [228](#)  
 Rear automatic climate control [131](#)  
 Rear axle steering [102](#)  
 Rear entertainment [201](#)  
 Rear lamps [260](#)  
 Rear seats, adjusting [53](#)  
 Rear seats, basic position [54](#)  
 Rear sockets [136](#)  
 Rear source, selecting for rear entertainment [204](#)  
 Rearview mirror [59](#)  
 Rear window defroster [129](#)  
 Recirculated-air mode [128](#)  
 Recommended tire brands [248](#)  
 Refueling [240](#)  
 Remaining range [76](#)  
 Reminders [227](#)  
 Remote control/key [32](#)  
 Remote control, malfunction [37](#)  
 Remote control, rear entertainment [202](#)  
 Remote control, universal [133](#)  
 Replacement fuse [263](#)  
 Replacing parts [258](#)  
 Replacing wheels/tires [248](#)  
 Reporting safety defects [8](#)  
 RES button [108](#)  
 Reserve warning, refer to Range [76](#)  
 Resetting, Tire Pressure Monitor TPM [93](#)  
 Residual heat, automatic climate control [129](#)  
 Retaining straps, securing cargo [149](#)  
 Retreaded tires [248](#)  
 Roadside Assistance [233](#)  
 Roadside parking lamps [86](#)  
 Roller sunblinds [46](#)  
 Roll stabilization, refer to Adaptive Drive [101](#)  
 Roll stabilization, refer to Dynamic Drive [101](#)  
 Roof load capacity [275](#)  
 Roof-mounted luggage rack [149](#)  
 Rope for tow-starting/towing [267](#)  
 Route [162](#)  
 Route criteria, route [161](#)  
 Route, displaying [162](#)  
 Routes, avoiding [162](#)  
 Route section, bypassing [163](#)  
 RSC Runflat System Components, refer to Run-flat tires [249](#)  
 Rubber components, care [270](#)  
 Run-flat tires [249](#)

## S

Safe braking [147](#)  
 Safety [7](#)  
 Safety belt reminder [56](#)  
 Safety belts [55](#)  
 Safety belts, care [271](#)  
 Safety switch, windows [46](#)  
 Safety systems, airbags [89](#)  
 Satellite radio [176](#)  
 Saving fuel [150](#)  
 Scale, changing during navigation [164](#)  
 Screen, refer to Control Display [19](#)  
 Screwdriver [258](#)  
 Screw thread for tow fitting [268](#)  
 Seat belts, refer to Safety belts [55](#)  
 Seat heating, front [52](#)  
 Seat heating, rear [54](#)  
 Seating position for children [62](#)  
 Seat, mirror, and steering wheel memory [58](#)  
 Seats [49](#)  
 Seats, rear, adjusting [53](#)  
 Seat ventilation, front [52](#)  
 Seat ventilation, rear [55](#)  
 Selection list in instrument cluster [78](#)  
 Selector lever, automatic transmission [74](#)  
 Self-leveling suspension, air suspension [102](#)



Self-leveling suspension, malfunction **103**  
Sensors, care **271**  
Service and warranty **7**  
Service requirements, CBS Condition Based Service **256**  
Service requirements, display **82**  
Service, Roadside Assistance **265**  
Settings on Control Display **81**  
Settings, storing for seat, mirrors, steering wheel **58**  
Shifting, automatic transmission **73**  
Short commands **277**  
Shoulder support **51**  
Side airbags **89**  
Side View **121**  
Signaling, horn **12**  
Signals when unlocking **37**  
Sitting safely **49**  
Size **274**  
Ski and snowboard bag **138**  
Slide/tilt glass roof **47**  
Smallest turning circle **275**  
Smoker's package **135**  
Snap-in adapter, mobile phone **219**  
Snow chains **249**  
Socket **135**  
Socket, OBD Onboard Diagnostics **256**  
Software applications, iPhone **236**  
Software update **199**  
Spare fuse **263**  
Special destinations, navigation **157**  
Specified engine oil types **254**  
Speed, average **79**  
Speed limit, setting **80**  
Speedometer **14**  
Split screen **23**  
Split screen map settings **165**

Spoken instructions, navigation **163**  
SPORT+ program, Dynamic Driving Control **104**  
SPORT program, Dynamic Driving Control **104**  
Sport program, transmission **75**  
Stability control systems **99**  
Start/Stop button **66**  
Start function during malfunction **33**  
Starting aid **265**  
Starting the engine **66**  
State/province, selecting for navigation **154**  
Stations, stored **180**  
Station, storing **174**  
Status display, tires **92**  
Status information, iDrive **22**  
Status of Owner's Manual **6**  
Steering, Integral Active Steering **102**  
Steering wheel, adjusting **61**  
Steering wheel heating **61**  
Steering wheel memory **58**  
Steptronic, automatic transmission **73**  
Stopping the engine **67**  
Storage compartment in the center console **141**  
Storage compartments **139**  
Storage compartments, locations **139**  
Storage, tires **249**  
Storing the vehicle **271**  
Street, entering for navigation **155**  
Summer tires, tread **247**  
Supplementary text message **84**  
Surround View **117**  
Suspension settings **103**  
Switch for Dynamic Driving Control **103**  
Switch-on times, parked-car ventilation **132**  
Switch, refer to Cockpit **12**

Symbols **6**

## T

Tachometer **77**  
Tail and brake lamps **261**  
Tailgate **39**  
Tailgate, automatic **40**  
Tailgate, emergency unlocking **42**  
Tailgate, hotel function **42**  
Tailgate via remote control **36**  
Tail lamps **260**  
Tail lamps, bulb replacement **261**  
Tasks **227**  
Technical changes, refer to Safety **7**  
Technical data **274**  
TeleService **232**  
Temperature, automatic climate control **128**  
Temperature display, external temperature **77**  
Temperature, engine oil **77**  
Tempomat, refer to Active Cruise Control **106**  
Terminal, starting aid **266**  
Text messages **224**  
Text message, supplementary **84**  
Theft alarm system, refer to Alarm system **44**  
Theft protection, lug bolts **262**  
Theft protection, refer to Central locking system **35**  
Thermal camera, refer to Night Vision **122**  
Thigh support **49**  
Through-loading system **136**  
Tilt alarm sensor **45**  
Tilt, seats **49**  
Time of arrival **80**  
Tire damage **247**  
Tire identification marks **246**  
Tire inflation pressure **243**

- Tire Pressure Monitor TPM [92](#)
  - Tires, changing [248](#)
  - Tires, everything on wheels and tires [243](#)
  - Tires, run-flat tires [249](#)
  - Tire tread [247](#)
  - Toll roads, route [162](#)
  - Tone [172](#)
  - Tool kit [258](#)
  - Tools [258](#)
  - Top View [117](#)
  - Total vehicle weight [275](#)
  - Tow fitting [267](#)
  - Towing [266](#)
  - Town/city, navigation [154](#)
  - Tow-starting [266](#)
  - TPM Tire Pressure Monitor [92](#)
  - Traction control [100](#)
  - TRACTION program, Dynamic Driving Control [103](#)
  - Traffic bulletins, navigation [165](#)
  - Traffic situation/gray card [166](#)
  - Transmission, automatic [73](#)
  - Transporting children safely [62](#)
  - Tread, tires [247](#)
  - Treble, tone [172](#)
  - Trip computer [80](#)
  - Triple turn signal activation [71](#)
  - Trip odometer [78](#)
  - Trunk cover [136](#)
  - Trunk lid [39](#)
  - Trunk lid, automatic [40](#)
  - Trunk lid, emergency unlocking [42](#)
  - Trunk lid, hotel function [42](#)
  - Trunk lid via remote control [36](#)
  - Turning circle [275](#)
  - Turning circle lines, backup camera [120](#)
  - Turn signals, front, bulb replacement [259](#)
  - Turn signals, operation [71](#)
  - Turn signals, rear, bulb replacement [261](#)
- ## U
- Unintentional alarm [45](#)
  - Units of measure [82](#)
  - Universal remote control [133](#)
  - Unlock button, automatic transmission [74](#)
  - Unlocking/locking from inside [38](#)
  - Unlocking/locking via door lock [38](#)
  - Unlocking/locking with remote control [36](#)
  - Updates made after the editorial deadline [6](#)
  - Updating software [199](#)
  - Upholstery care [270](#)
  - USB audio interface [193](#)
  - USB interface [139](#)
- ## V
- Variable steering, Integral Active Steering [102](#)
  - Vehicle battery [262](#)
  - Vehicle battery, replacing [262](#)
  - Vehicle, breaking in [146](#)
  - Vehicle care [270](#)
  - Vehicle identification number, refer to Identification number in the engine compartment [251](#)
  - Vehicle jack [262](#)
  - Vehicle paint [270](#)
  - Vehicle storage [271](#)
  - Vehicle wash [269](#)
  - Ventilation [130](#)
  - Ventilation, refer to Parked-car ventilation [132](#)
  - Version of the navigation data [168](#)
  - Video playback [183](#)
  - Video playback, iPhone [195](#)
  - Video playback, snap-in adapter [195](#)
  - Voice activation, mobile phone [217](#)
  - Voice activation, short commands [277](#)
  - Voice activation system [25](#)
  - Volume, setting [172](#)
- ## W
- Warning lamps [14](#)
  - Warning messages, refer to Check Control [83](#)
  - Warning triangle [265](#)
  - Washer fluid [73](#)
  - Washer fluid reservoir, capacity [276](#)
  - Washer nozzles, windshield [73](#)
  - Washer system [71](#)
  - Washing, vehicle [269](#)
  - Water on roads [147](#)
  - Weather Band [176](#)
  - Weights [275](#)
  - Welcome lamps [85](#)
  - Wheel base, vehicle [275](#)
  - Wheel change [261](#)
  - Wheels, changing [248](#)
  - Wheels, everything on wheels and tires [243](#)
  - Wheels, Tire Pressure Monitor TPM [92](#)
  - Width with mirrors, vehicle [274](#)
  - Width without mirrors, vehicle [274](#)
  - Window defroster, rear [129](#)
  - Windows, powered [45](#)
  - Windshield, climate control [147](#)
  - Windshield washer fluid [73](#)
  - Windshield washer nozzles [73](#)
  - Windshield washer system [71](#)
  - Windshield wiper [71](#)
  - Windshield wipers, fold-out position [73](#)
  - Winter storage, care [271](#)
  - Winter tires, suitable tires [249](#)

Winter tires, tread [247](#)  
Wiper blades, replacing [258](#)  
Wiper fluid [73](#)  
Wiper system [71](#)  
Wood, care [271](#)  
Word match concept, navigation [24](#)  
Wrench [258](#)

## X

xDrive [100](#)  
Xenon headlamps, bulb replacement [259](#)

## Y

Your individual vehicle [6](#)



More about BMW



[bmwusa.com](http://bmwusa.com)

The Ultimate Driving Machine

01 40 2 606 445 Ue



Online Edition for Part no. 01 40 2 606 445 - 03 11 490