

TABLE OF CONTENTS

| SECTION | | PAGE |
|---------|---|------|
| 1 | INTRODUCTION | 3 |
| 2 | THINGS TO KNOW BEFORE STARTING YOUR VEHICLE | 9 |
| 3 | UNDERSTANDING THE FEATURES OF YOUR VEHICLE | 59 |
| 4 | UNDERSTANDING YOUR INSTRUMENT PANEL | 131 |
| 5 | STARTING AND OPERATING | 193 |
| 6 | WHAT TO DO IN EMERGENCIES | 255 |
| 7 | MAINTAINING YOUR VEHICLE | 269 |
| 8 | MAINTENANCE SCHEDULES | 317 |
| 9 | IF YOU NEED CONSUMER ASSISTANCE | 337 |
| 10 | INDEX | 345 |

INTRODUCTION

CONTENTS

| | | | |
|------------------------------------|---|---|---|
| ■ Introduction | 4 | ■ Vehicle Identification Number | 6 |
| ■ How To Use This Manual | 4 | ■ Vehicle Modifications / Alterations | 7 |
| ■ Warnings And Cautions | 6 | | |

4 INTRODUCTION

INTRODUCTION

This manual has been prepared with the assistance of service and engineering specialists to acquaint you with the operation and maintenance of your new vehicle. It is supplemented by a Warranty Information Booklet and various customer oriented documents. You are urged to read these publications carefully. Following the instructions and recommendations in this manual will help assure safe and enjoyable operation of your vehicle.

NOTE: After you read the manual, it should be stored in the vehicle for convenient reference and remain with the vehicle when sold, so that the new owner will be aware of all safety warnings.

When it comes to service, remember that your dealer knows your vehicle best, has the factory-trained technicians and genuine Mopar® parts, and is interested in your satisfaction.

WARNING!









Engine exhaust, some of its constituents and certain vehicle components contain or emit chemicals known to the State of California to cause cancer and birth defects or other reproductive harm. In addition, certain fluids contained in vehicles and certain products of component wear contain or emit chemicals known to the State of California to cause cancer and birth defects or other reproductive harm.

HOW TO USE THIS MANUAL

Consult the table of contents to determine which section contains the information you desire.

The detailed index, at the rear of this manual, contains a complete listing of all subjects.

Consult the following table for a description of the symbols that may be used on your vehicle or throughout this owner's manual:

| | | | | | | | | | | | |
|---|---|---|---|---|---|---|--|---|---|---|---|
|  |  |  |  |  |  |  |  |  |  |  |  |
| WATER IN FUEL | REAR WINDOW WIPER | WINDSHIELD WIPER INTERMITTENT | EXTERIOR BULB FAILURE | HIGH BEAM | TURN SIGNALS | UPPER AIR OUTLET | HEATED SEAT LOW | DOOR LOCK | ADJUSTABLE PEDALS | ELECTRONIC SPEED CONTROL | ELECTRONIC STABILITY PROGRAM / BRAKE ASSIST SYSTEM |
|  |  |  |  |  |  |  |  |  |  |  |  |
| FUEL | REAR WINDOW INTERMITTENT WIPER | WINDSHIELD WASHER | MASTER LIGHTING SWITCH | LOW BEAM | KEY ACTIVATE (POWER OUTLET) | UPPER AND LOWER AIR OUTLET | HEATED SEAT HIGH | WINDOW LIFT | TIRE PRESSURE MONITOR | HILL DESCENT CONTROL | BRAKE SYSTEM WARNING PARKING BRAKE |
|  |  |  |  |  |  |  |  |  |  |  |  |
| FUEL FILL SIDE | REAR WINDOW WASHER | WINDSHIELD WASHER FLUID LEVEL | DOME LIGHT | FRONT FOG LIGHT | HOOD RELEASE | LOWER AIR OUTLET | RECIRCULATION | CONVERTIBLE 4 WINDOW DOWN | TRACTION CONTROL | AWD! | FAILURE OF ANTILOCK BRAKING SYSTEM |
|  |  |  |  |  |  |  |  |  |  |  |  |
| ENGINE OIL | REAR WINDOW DEFROST | WINDSHIELD, ELECTRICALLY HEATED | PARK LIGHTS | REAR FOG LAMP | LIFTGATE RELEASE AND LIFTGATE OPEN | DEFROST AND LOWER AIR OUTLET | VENTILATING FAN | WINDOW LOCK | ELECTRONIC THROTTLE CONTROL | 4WD! | BRAKE SYSTEM WARNING PARKING BRAKE |
|  |  |  |  |  |  |  |  |  |  |  | |
| BATTERY CHARGING | HEATED MIRROR | WINDSHIELD DEFROST | INSTRUMENT PANEL ILLUMINATION | SEAT BELT | SLIDING DOOR | TRUNK / DECK RELEASE | AIR CONDITIONING | CHILD SEAT TETHER ANCHOR | VOICE RECOGNITION BUTTON | WARNING | |
|  |  |  |  |  |  |  |  |  |  |  | |
| GLOW PLUG | POWER STEERING FLUID | WINDSHIELD WIPER AND WASHER | SIDE AIRBAG | AIRBAG | SLIDING DOOR | EMERGENCY RELEASE HANDLE | LIGHTER | LOWER ANCHORS AND TETHER FOR CHILDREN (LATCH) | UCDCONNECT™ BUTTON | HAZARD | |
|  |  |  |  |  |  |  |  |  |  |  | |
| MALFUNCTION INDICATOR LIGHT | TRANS OIL TEMP | ENGINE COOLANT TEMPERATURE | SRS AIRBAG | SUPPLEMENTAL RESTRAINT SYSTEM | PASSENGER AIRBAG OFF | DOOR AJAR | CONVERTIBLE TOP DOWN | CONVERTIBLE TOP UP | HORN | SEE OWNER'S MANUAL ISO | |

WARNINGS AND CAUTIONS

This manual contains **WARNINGS** against operating procedures, which could result in an accident or bodily injury. It also contains **CAUTIONS** against procedures, which could result in damage to your vehicle. If you do not read this entire manual, you may miss important information. Observe all Warnings and Cautions.

VEHICLE IDENTIFICATION NUMBER

The vehicle identification number (VIN) is on the left front corner of the instrument panel. The VIN is visible from outside of the vehicle through the windshield. This number also appears on the Automobile Information Disclosure Label affixed to a window on your vehicle, the vehicle registration, and the title.

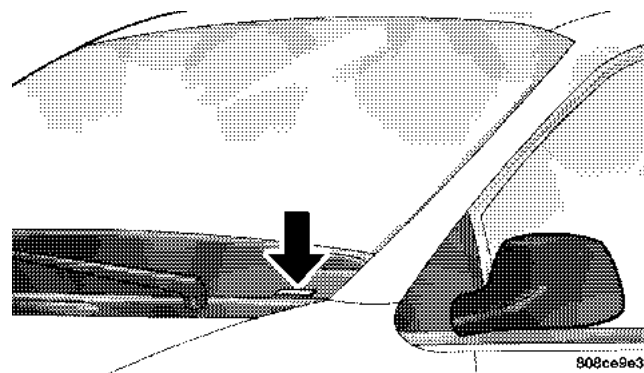

VIN LOCATION

NOTE: It is illegal to remove the VIN.

VEHICLE MODIFICATIONS / ALTERATIONS**WARNING!**

Any modifications or alterations to this vehicle could seriously affect its roadworthiness and safety and may lead to an accident resulting in serious injury or death.

THINGS TO KNOW BEFORE STARTING YOUR VEHICLE

CONTENTS

| | | | |
|---|-----|---|-----|
| ■ A Word About Your Keys | .11 | ■ Illuminated Entry System | .17 |
| □ Ignition Key Removal | .11 | ■ Remote Keyless Entry | .17 |
| □ Key-In-Ignition Reminder | .12 | □ To Unlock The Doors | .18 |
| ■ Sentry Key | .12 | □ To Lock The Doors | .18 |
| □ Replacement Keys | .13 | □ To Unlatch The Trunk | .19 |
| □ Customer Key Programming | .14 | □ Using The Panic Alarm | .19 |
| □ General Information | .15 | □ Programming Additional Transmitters | .19 |
| ■ Security Alarm System — If Equipped | .15 | □ Battery Replacement | .19 |
| □ Rearming Of The System | .15 | □ General Information | .20 |
| □ To Arm The System | .15 | ■ Door Locks | .21 |
| □ To Disarm The System | .16 | □ Manual Door Locks | .21 |

10 THINGS TO KNOW BEFORE STARTING YOUR VEHICLE

| | | | |
|---|-----|--|-----|
| □ Power Door Locks | .21 | □ Seat Belts And Pregnant Women | .37 |
| □ Child Protection Door Lock | .23 | □ Seat Belt Extender | .37 |
| ■ Windows | .25 | □ Driver And Front Passenger Supplemental Restraint System (SRS) - Airbag | .38 |
| □ Power Windows | .25 | □ Event Data Recorder (EDR) | .46 |
| □ Wind Buffeting | .27 | □ Child Restraint | .47 |
| ■ Trunk Lock And Release | .28 | ■ Break-In Recommendations | .55 |
| ■ Trunk Safety Warning | .29 | ■ Safety Tips | .56 |
| □ Trunk Emergency Release | .29 | □ Transporting Passengers | .56 |
| ■ Occupant Restraints | .30 | □ Lock Your Vehicle | .56 |
| □ Lap/Shoulder Belts | .30 | □ Exhaust Gas | .56 |
| □ Lap/Shoulder Belt Untwisting Procedure | .35 | □ Safety Checks You Should Make Inside The Vehicle | .57 |
| □ Seat Belt Pretensioners | .35 | □ Periodic Safety Checks You Should Make Outside The Vehicle | .58 |
| □ Enhanced Seat Belt Reminder System (BeltAlert) | .35 | | |
| □ Automatic Locking Mode — If Equipped | .36 | | |

A WORD ABOUT YOUR KEYS

You can insert the double-sided keys into the locks with either side up.

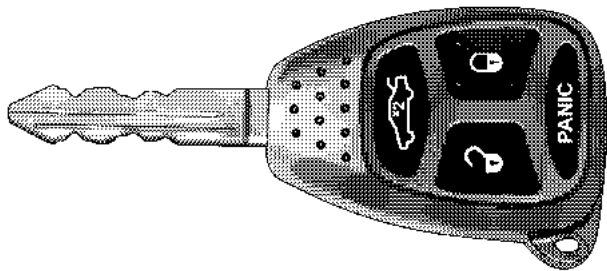

815af31a

Vehicle Key

The dealer that sold you your new vehicle has the key code numbers for your vehicle locks. These numbers can be used to order duplicate keys from your dealer. Ask your dealer for these numbers and keep them in a safe place.

Ignition Key Removal

The shift lever must be in PARK. Turn the key to the LOCK position, and then remove the key.

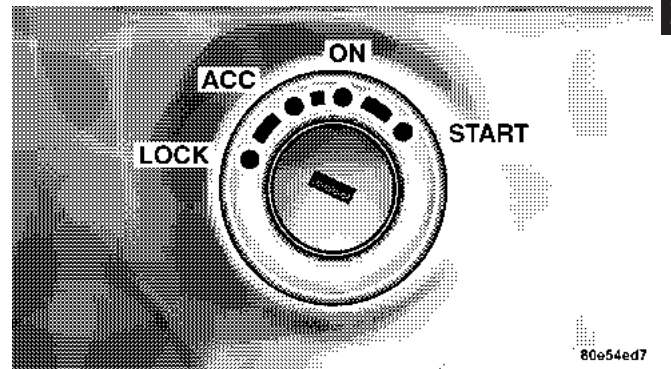

80e54ed7

Ignition Key Positions

NOTE: The power window switches, radio, power sunroof (if equipped), and power outlets will remain active for up to 60 minutes after the ignition switch is turned off. Opening either front door will cancel this feature. The time for this feature is programmable. For details, refer to “Delay Power Off to Accessories Until

12 THINGS TO KNOW BEFORE STARTING YOUR VEHICLE

Exit,” under “Personal Settings (Customer Programmable Features),” under “Electronic Vehicle Information Center (EVIC)” in Section 4 of this manual.

WARNING!

Never leave children alone in a vehicle. Leaving children in a vehicle unattended is dangerous for a number of reasons. A child or others could be seriously or fatally injured. Don't leave the keys in the ignition. A child could operate power windows, other controls, or move the vehicle.

CAUTION!

An unlocked car is an invitation to thieves. Always remove key from the ignition and lock all doors when leaving the vehicle unattended.

Key-In-Ignition Reminder

If you open the driver's door and the key is in the ignition switch, a chime will sound to remind you to remove the key.

NOTE: The Key-In-Ignition reminder only sounds when the ignition key is placed in the LOCK or ACC positions.

SENTRY KEY

The Sentry Key Immobilizer System prevents unauthorized vehicle operation by disabling the engine. The system does not need to be armed or activated. Operation is automatic, regardless of whether the vehicle is locked or unlocked.

The system uses ignition keys, which have an embedded electronic chip (transponder), to prevent unauthorized vehicle operation. Therefore, only keys that are programmed to the vehicle can be used to start and operate the vehicle. The system will shut the engine off in two (2) seconds if someone uses an invalid key to start the engine.

NOTE: A key, which has not been programmed, is also considered an invalid key even if it is cut to fit the ignition lock cylinder for that vehicle.

During normal operation, after turning on the ignition switch, the Vehicle Security Alarm Indicator Light will turn on for three (3) seconds for a bulb check. If the light remains on after the bulb check, it indicates that there is a problem with the electronics. In addition, if the light begins to flash after the bulb check, it indicates that someone used an invalid key to start the engine. Either of these conditions will result in the engine being shut off after two (2) seconds.

If the Vehicle Security Alarm Indicator Light turns on during normal vehicle operation (vehicle running for longer than 10 seconds), it indicates that there is a fault in the electronics. Should this occur, have the vehicle serviced as soon as possible.

NOTE:

- The Sentry Key Immobilizer System is not compatible with remote starting systems. Use of these systems may result in vehicle starting problems and loss of security protection.

- Exxon/Mobil Speed Pass,TM additional Sentry Keys, or any other transponder-equipped components on the same key chain will **not** cause a key-related (transponder) fault unless the additional part is **physically held against the ignition key** being used when starting the vehicle. Cell phones, pagers, or other RF electronics will not cause interference with this system.

All of the keys provided with your new vehicle have been programmed to the vehicle electronics.

Replacement Keys

NOTE: Only keys that are programmed to the vehicle electronics can be used to start and operate the vehicle. Once a Sentry Key is programmed to a vehicle, it cannot be programmed to any other vehicle.

At the time of purchase, the original owner is provided with a four-digit PIN number. This number is required for dealer replacement of keys. Duplication of keys may be performed at an authorized dealer or by using the Customer Key Programming procedure. This procedure

14 THINGS TO KNOW BEFORE STARTING YOUR VEHICLE

consists of programming a blank key to the vehicle electronics. A blank key is one, which has never been programmed.

NOTE: When having the Sentry Key Immobilizer System serviced, bring all vehicle keys with you to the dealer.

Customer Key Programming

If you have two valid sentry keys, you can program new sentry keys to the system by performing the following procedure:

1. Cut the additional Sentry Key Transponder blank(s) to match the ignition switch lock cylinder key code.
2. Insert the first valid key into the ignition switch and turn the ignition switch ON for at least 3 seconds but no longer than 15 seconds. Turn the ignition switch OFF and remove the first key.
3. Insert the second valid key and turn the ignition switch ON within 15 seconds. After ten seconds, a chime will sound and the Vehicle Security Alarm Indicator Light will begin to flash. Turn the ignition switch OFF and remove the second key.

4. Insert a blank Sentry Key into the ignition switch and turn the ignition switch ON within 60 seconds. After 10 seconds, a single chime will sound and the Vehicle Security Alarm Indicator Light will stop flashing, turn on again for 3 seconds, and then turn off.

The new Sentry Key is programmed. **The Keyless Entry Transmitter will also be programmed during this procedure.**

Repeat this procedure to program up to 8 keys. If you do not have a programmed sentry key, contact your dealer for details.

NOTE: If a programmed key is lost, see your dealer to have all remaining keys erased from the systems memory. This will prevent the lost key from starting your vehicle. The remaining keys must then be reprogrammed. All vehicle keys must be taken to the dealer at the time of service to be reprogrammed.

General Information

The Sentry Key system complies with FCC rules part 15 and with RSS-210 of Industry Canada. Operation is subject to the following conditions:

- This device may not cause harmful interference.
- This device must accept any interference that may be received, including interference that may cause undesired operation.

SECURITY ALARM SYSTEM — IF EQUIPPED

The Vehicle Security Alarm system monitors the vehicle doors for unauthorized entry and the ignition switch for unauthorized operation. If something triggers the alarm, the system will prevent the vehicle from starting and provide the following audible and visual signals: the horn will pulse; the headlights will flash; the park lights will flash; and the Vehicle Security Alarm Indicator light in the instrument cluster will flash.

Rearming of the System:

If something triggers the alarm, and no action is taken to disarm it, the system will turn off the horn after 3 minutes, turn off all of the visual signals after 15 minutes, and then the system will rearm itself.

To Arm the System:

Remove the key from the ignition switch and either press a power door lock switch while the driver or passenger door is open or press the LOCK button on the keyless entry transmitter. After the last door is closed, or if all doors are closed, the system will arm itself in about 16 seconds. During that time, the Vehicle Security Alarm Indicator light will flash. If it does not illuminate, the system is not arming. Also, if you open a door during the arming period, the system will cancel the arming process. If you wish to rearm the system after closing the door, you must repeat one of the previously described arming sequences.

To Disarm the System:

Either press the UNLOCK button on the remote keyless entry transmitter or insert a valid sentry key into the ignition lock cylinder and turn the key to the ON/START position.

NOTE:

- The driver's door key cylinder and the trunk button on the keyless entry transmitter cannot arm or disarm the system.
- The system remains armed during trunk entry. Pressing the trunk button will not disarm the system. If someone enters the vehicle through the trunk and opens any door the alarm will sound.
- When the system is armed, the interior power door lock switches will not unlock the doors.

The Vehicle Security Alarm system is designed to protect your vehicle; however, you can create conditions where the system will give you a false alarm. If one of the previously described arming sequences has occurred, the system will arm regardless of whether you are in the vehicle or not. If you remain in the vehicle and open a door, the alarm will sound. If this occurs, disarm the system.

If the alarm system is armed and the battery becomes disconnected the system will remain armed when the battery is reconnected. The exterior lights will flash, the horn will sound, and the ignition will not start the vehicle. If this occurs, disarm the system.

Tamper Alert

If something has triggered the system in your absence, the horn will sound three times when you disarm the system. Check the vehicle for tampering.

ILLUMINATED ENTRY SYSTEM

The courtesy lights will turn on when you use the keyless entry transmitter or open the doors.

The lights will fade to off after about 30 seconds or they will immediately fade to off once the ignition switch is turned ON from the LOCK position.

NOTE:

- None of the courtesy lights will operate if the dimmer control is in the “defeat” position (extreme downward position), unless the overhead map/reading lights are turned on manually.

REMOTE KEYLESS ENTRY

This system allows you to lock or unlock the doors, open the trunk, or activate the panic alarm from distances up to about 23 feet (7 meters) using a hand held radio transmitter. The transmitter need not be pointed at the vehicle to activate the system.

NOTE: Inserting the key into the ignition switch disables all buttons on that transmitter; however, the buttons on the remaining transmitters will continue to work. Shifting the vehicle out of PARK disables all transmitter buttons for all keys.

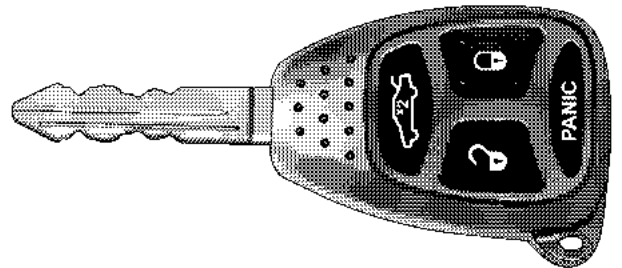

815afa1a

Keyless Entry Transmitter

To unlock the doors:

Press and release the UNLOCK button on the transmitter once to unlock the driver's door, or twice to unlock all doors. The turn signal lights will flash to acknowledge the unlock signal. The illuminated entry system will also turn on.

Remote Key Unlock, Driver Door/All Doors First

This feature lets you program the system to unlock either the driver's door or all doors on the first press of the UNLOCK button on the transmitter. For details on how to change the current setting, refer to "Remote Key Unlock," under "Personal Settings (Customer Programmable Features)," under "Electronic Vehicle Information Center (EVIC)" in Section 4 of this manual.

Flash Lights with Remote Key Lock

This feature will cause the turn signal lights to flash when the doors are locked or unlocked with the transmitter. This feature can be enabled or disabled. For details on how to change the current setting, refer to "Flash Lights

with Remote Key Lock," under "Personal Settings (Customer Programmable Features)," under "Electronic Vehicle Information Center (EVIC)" in Section 4 of this manual.

Turn Headlights On with Remote Key Unlock

This feature activates the headlights for up to 90 seconds when the doors are unlocked with the transmitter. The time for this feature is programmable. For details on how to change the current setting, refer to "Turn Headlights On with Remote Key Unlock," under "Personal Settings (Customer Programmable Features)," under "Electronic Vehicle Information Center (EVIC)" in Section 4 of this manual.

To lock the doors:

Press and release the LOCK button on the transmitter to lock all doors. The turn signal lights will flash and the horn will chirp to acknowledge the signal.

Sound Horn with Remote Key Lock

This feature will cause the horn to chirp when the doors are locked with the transmitter. This feature can be enabled or disabled. For details on how to change the current setting, refer to "Sound Horn with Remote Key

Lock,” under “Personal Settings (Customer Programmable Features),” under “Electronic Vehicle Information Center (EVIC)” in Section 4 of this manual.

To unlatch the trunk:

Press the trunk button on the transmitter two times to unlatch the trunk.

Using The Panic Alarm:

To turn the panic alarm feature ON or OFF, press and hold the PANIC button on the transmitter for at least one second and release. When the panic alarm is on, the headlights and park lights will flash, the horn will pulse on and off, and the interior lights will turn on.

The panic alarm will stay on for 3 minutes unless you turn it off by either pressing the PANIC button a second time or drive the vehicle at a speed of 15 mph (24 km/h) or greater.

NOTE:

- The interior lights will turn off if you turn the ignition switch to the ACC or ON position while the panic alarm is activated. However, the exterior lights and horn will remain on.

- You may need to be less than 23 feet (7 meters) from the vehicle when using the transmitter to turn off the panic alarm due to the radio frequency noises emitted by the system.

Programming Additional Transmitters

Refer to SENTRY KEY “Customer Key Programming.” (See page 14 for more information.)

If you do not have a programmed transmitter, contact your dealer for details.

Battery Replacement

The recommended replacement battery is CR2032.

NOTE: Do not touch the battery terminals that are on the back housing or the printed circuit board.

1. With the transmitter buttons facing downward, remove the small screw (if equipped).
2. Separate the two halves of the transmitter with a flat blade tool. Do not damage the rubber seal during removal.

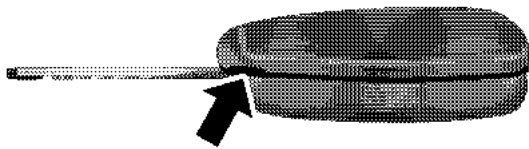

81182c72

Separating Transmitter Halves

3. Remove and replace the battery. Avoid touching the new battery with your fingers. Skin oils may cause battery deterioration. If you touch a battery, clean it with rubbing alcohol.
4. To assemble the transmitter case, snap the two halves together. If so equipped, install and tighten the screw until snug. Make sure there is an even "gap" between the two halves.
5. Test the transmitter operation.

General Information

This device complies with part 15 of the FCC rules and RSS 210 of Industry Canada. Operation is subject to the following conditions:

- This device may not cause harmful interference.
- This device must accept any interference received, including interference that may cause undesired operation.

NOTE: Changes or modifications not expressly approved by the party responsible for compliance could void the user's authority to operate the equipment.

If your Remote Keyless Entry transmitter fails to operate from a normal distance, check for these two conditions.

1. A weak battery in the transmitter. The expected life of the battery is a minimum of three years.
2. Closeness to a radio transmitter such as a radio station tower, airport transmitter, and some mobile or CB radios.

DOOR LOCKS

Manual Door Locks

To lock each door, push the door lock plunger on each door trim panel downward. To unlock each door, pull the door lock plunger on each door trim panel upward.

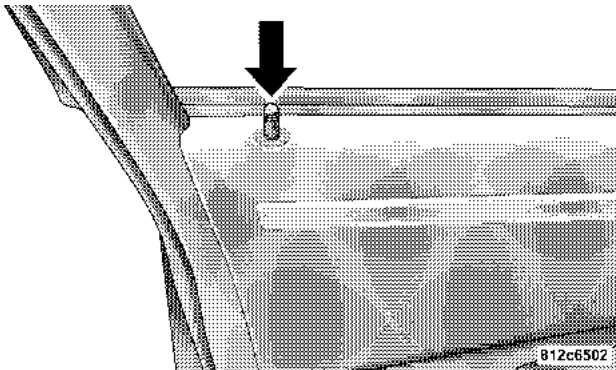

Door Lock Plunger

If the door lock plunger is down when you shut the door, the door will lock. Therefore, make sure the keys are not inside the vehicle before closing the door.

WARNING!

- For personal security and safety in the event of an accident, lock the vehicle doors as you drive as well as when you park and leave the vehicle.
- When leaving the vehicle always remove the key from the ignition lock, and lock your vehicle. Unsupervised use of vehicle equipment may cause severe personal injuries and death.
- Never leave children alone in a vehicle. Leaving children in a vehicle unattended is dangerous for a number of reasons. A child or others could be seriously or fatally injured. Don't leave the keys in the ignition. A child could operate power windows, other controls, or move the vehicle.

2

Power Door Locks

A power door lock switch is on each front door trim panel. Use this switch to lock or unlock the doors.

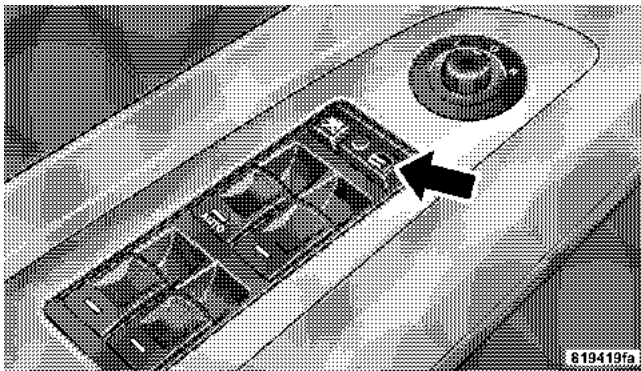

Power Door Lock Switch

If you press the power door lock switch while the key is in the ignition, and any front door is open, the power locks will not operate. This prevents you from accidentally locking your keys in the vehicle. Removing the key or closing the door will allow the locks to operate. A chime will sound if the key is in the LOCK or ACC position and a door is open, as a reminder to remove the key.

Automatic Door Locks

The doors will lock automatically on vehicles with power door locks if all of the following conditions are met:

1. The Automatic Door Locks feature is enabled.
2. The transmission is in gear.
3. All doors are closed.
4. The throttle is pressed.
5. The vehicle speed is above 15 mph (24 km/h).
6. The doors were not previously locked using the power door lock switch or remote keyless entry transmitter.

Automatic Door Locks Programming

The Automatic Door Locks feature can be enabled or disabled. For details, refer to "Lock Doors Automatically at 15 mph (24 Km/h)," under "Personal Settings (Customer Programmable Features)," under "Electronic Vehicle Information Center (EVIC)" in Section 4 of this manual.

Automatic Unlock Doors on Exit

The doors will unlock automatically on vehicles with power door locks if:

1. The Automatic Unlock Doors On Exit feature is enabled.
2. The transmission was in gear and the vehicle speed returned to 0 mph (0 km/h).
3. The transmission is in NEUTRAL or PARK.
4. The driver door is opened.
5. The doors were not previously unlocked.
6. The vehicle speed is 0 mph (0 km/h).

Automatic Unlock Doors on Exit Programming

The Automatic Unlock Doors On Exit feature can be enabled or disabled. For details, refer to "Unlock Doors Automatically on Exit," under "Personal Settings (Customer Programmable Features)," under "Electronic Vehicle Information Center (EVIC)" in Section 4 of this manual.

Child Protection Door Lock

To provide a safer environment for small children riding in the rear seats, the rear doors are equipped with a child protection door lock system.

To Engage the Child Protection Door Lock

1. Open the rear door.
2. Insert the tip of the vehicle's ignition key or alike into the child lock control and pull it upward.

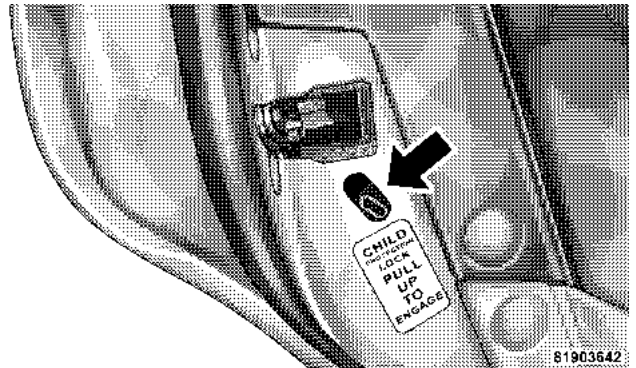

Child Lock Control

24 THINGS TO KNOW BEFORE STARTING YOUR VEHICLE

3. Repeat Steps 1 and 2 on the opposite rear door.

NOTE: When the child lock system is engaged, the door can be opened only by using the outside door handle even though the inside door lock is in the unlocked position.

WARNING!

Avoid trapping anyone in a vehicle in a collision. Remember that the rear doors can only be opened from the outside when the child protection locks are engaged.

NOTE:

- After engaging the child protection door lock system, always test the door from the inside to make certain it is in the desired position.
- For emergency exit with the system engaged, move the door lock switch to the UNLOCK position, roll down the window and open the door with the outside door handle.

To Disengage the Child Protection Door Lock

1. Open the rear door.
2. Insert the tip of the vehicle's ignition key or alike into the child lock control and pull it downward.

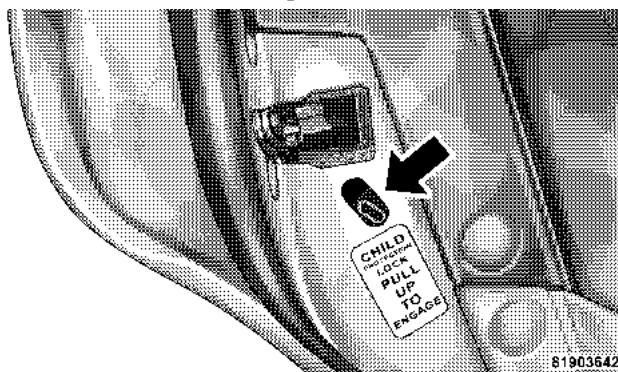

Child Lock Control

3. Repeat Steps 1 and 2 on the opposite rear door.

NOTE: After disengaging the child protection door lock system, always test the door from the inside to make certain it is in the desired position.

WINDOWS

Power Windows

The window controls on the driver's door control all the door windows.

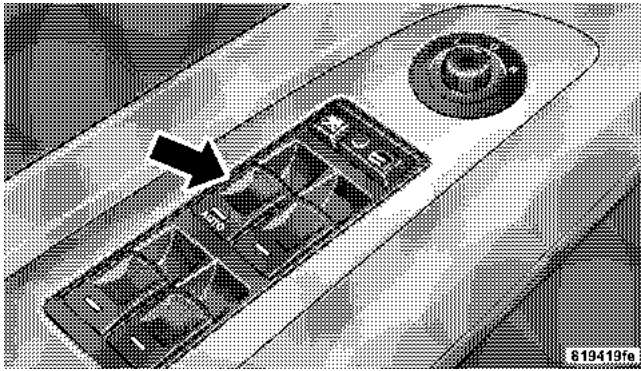

Power Window Switches

There are single window controls on each passenger door trim panel, which operate the passenger door windows. The window controls will operate only when the ignition switch is in the ON or ACCESSORY position.

WARNING!

Never leave children in a vehicle, with the keys in the ignition switch. Occupants, particularly unattended children, can become entrapped by the windows while operating the power window switches. Such entrapment may result in serious injury or death.

2

Auto Down Feature

The driver door power window switch, and some model passenger door power window switches have an auto down feature. Press the window switch to the second detent, release, and the window will go down automatically.

To open the window part way, press the window switch to the first detent and release it when you want the window to stop.

To stop the window from going all the way down during the auto-down operation, pull up on the switch briefly.

The power window switches will remain active for up to 60 minutes after the ignition switch is turned off. Opening either front door will cancel this feature. The time for this feature is programmable. For details, refer to “Delay Power Off to Accessories Until Exit,” under “Personal Settings (Customer Programmable Features),” under “Electronic Vehicle Information Center (EVIC)” in Section 4 of this manual.

Auto Up Feature with Anti-Pinch Protection — If Equipped

Lift the window switch to the second detent, release, and the window will go up automatically.

To stop the window from going all the way up during the auto-up operation, push down on the switch briefly.

To close the window part way, lift the window switch to the first detent and release it when you want the window to stop.

The power window switches will remain active for up to 60 minutes after the ignition switch is turned off. Opening either front door will cancel this feature. The time for this feature is programmable. For details, refer to “Delay

Power Off to Accessories Until Exit,” under “Personal Settings (Customer Programmable Features),” under “Electronic Vehicle Information Center (EVIC)” in Section 4 of this manual.

NOTE:

- If the window runs into any obstacle during auto-closure, it will reverse direction and then stop. Remove the obstacle and use the window switch again to close the window.
- Any impact due to rough road conditions may trigger the auto reverse function unexpectedly during auto-closure. If this happens, pull the switch lightly to the first detent and hold to close window manually.

WARNING!

There is no anti-pinch protection when the window is almost closed. Be sure to clear all objects from the window before closing.

Window Lockout Switch

The window lockout switch on the driver's door allows you to disable the window controls on the passenger doors. When the switch is pressed, the window controls on the passenger doors will not illuminate and the passenger windows will be disabled.

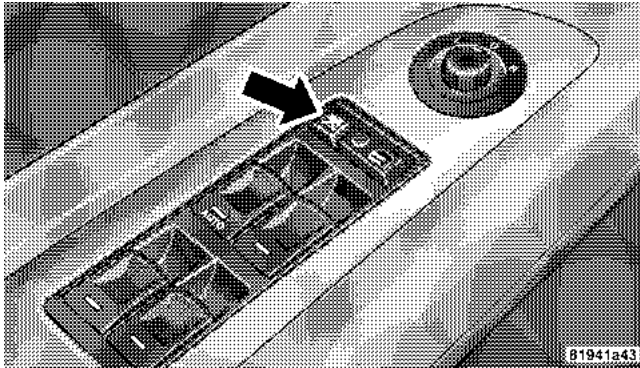

Window Lockout Switch

Reset

Any time the vehicle battery is disconnected, or goes dead, the auto-up function will be disabled. To reactivate the auto-up feature, perform the following steps after vehicle power is restored:

1. Pull the window switch up to close window completely and continue to hold the switch up for an additional two seconds after the window is closed.
2. Push the window switch down firmly to the second detent to open the window completely and continue to hold the switch down for an additional two seconds after the window is fully open.

Wind Buffeting

Wind buffeting can be described as the perception of pressure on the ears or a helicopter type sound in the ears. Your vehicle may exhibit wind buffeting with the windows down, or the sunroof (if equipped) in certain open or partially open positions. This is a normal occurrence and can be minimized. If the buffeting occurs with the rear windows open, then open the front and rear windows together to minimize the buffeting. If the

buffeting occurs with the sunroof open, then adjust the sunroof opening to minimize the buffeting.

TRUNK LOCK AND RELEASE

The trunk lid can be released from inside the vehicle by pressing the Trunk Release Button located on the instrument panel to the left of the steering wheel.

NOTE: The transmission must be in Park before the switch will operate.

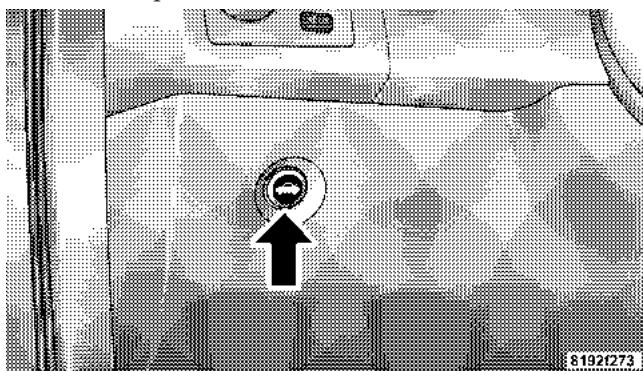

Trunk Release Button

The trunk lid can be released from outside the vehicle by pressing the trunk button on the Remote Keyless Entry Transmitter two times.

With the ignition ON, the trunk open symbol will display in the instrument cluster indicating that the trunk is open. The odometer display will reappear once the trunk is closed.

With the key in the lock position or key out, the trunk open symbol will display until the trunk is closed.

TRUNK SAFETY WARNING**WARNING!**

Do not allow children to have access to the trunk, either by climbing into the trunk from outside, or through the inside of the vehicle. Always close the trunk lid when your vehicle is unattended. Once in the trunk, young children may not be able to escape, even if they entered through the rear seat. If trapped in the trunk, children can die from suffocation or heat stroke.

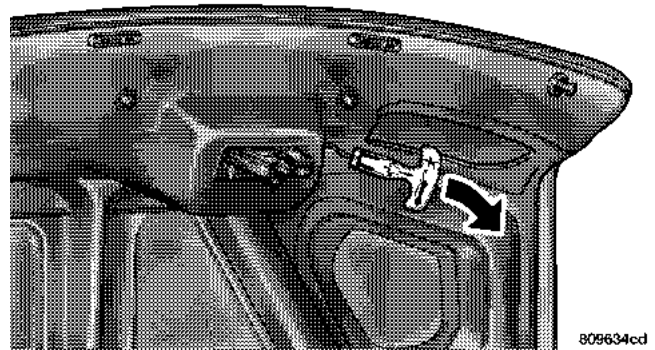
Trunk Emergency Release**Emergency Release**

The trunk of your vehicle is equipped with an emergency release handle. It is located on the inside of the trunk lid, near the latch, and is coated so that it glows in a darkened trunk. Pull on the handle to open the trunk.

OCCUPANT RESTRAINTS

Some of the most important safety features in your vehicle are the restraint systems. These include the front and rear seat belts for the driver and all passengers, front airbags for both the driver and front passenger and, if so equipped, side curtain airbags for the driver and passengers seated next to a window. If you will be carrying children too small for adult-size belts, your seat belts also can be used to hold infant and child restraint systems.

Please pay close attention to the information in this section. It tells you how to use your restraint system properly to keep you and your passengers as safe as possible.

WARNING!

In a collision, you and your passengers can suffer much greater injuries if you are not properly buckled up. You can strike the interior of your vehicle or other passengers, or you can be thrown out of the vehicle. Always be sure you and others in your vehicle are buckled up properly.

Buckle up even though you are an excellent driver, even on short trips. Someone on the road may be a poor driver and cause a collision that includes you. This can happen far away from home or on your own street.

Research has shown that seat belts save lives, and they can reduce the seriousness of injuries in a collision. Some of the worst injuries happen when people are thrown from the vehicle. Seat belts reduce the possibility of ejection and the risk of injury caused by striking the inside of the vehicle. **Everyone** in a motor vehicle should be belted at all times.

Lap/Shoulder Belts

All seating positions in your vehicle are equipped with Lap/Shoulder Belts.

The belt webbing retractor is designed to lock during very sudden stops or impacts. This feature allows the shoulder part of the belt to move freely with you under normal conditions. However, in a collision, the belt will lock and reduce your risk of striking the inside of the vehicle or being thrown out.

WARNING!

- It is extremely dangerous to ride in a cargo area, inside or outside of a vehicle. In a collision, people riding in these areas are more likely to be seriously injured or killed.
- Do not allow people to ride in any area of your vehicle that is not equipped with seats and seat belts.
- Be sure everyone in your vehicle is in a seat and using a seat belt properly.
- Wearing a seat belt incorrectly is dangerous. Seat belts are designed to go around the large bones of your body. These are the strongest parts of your body and can take the forces of a collision the best.
- Wearing your belt in the wrong place could make your injuries in a collision much worse. You might suffer internal injuries, or you could even slide out of part of the belt. Follow these instructions to wear your seat belt safely and to keep your passengers safe, too.
- Two people should never be belted into a single seat belt. People belted together can crash into one another in an accident, hurting one another badly. Never use a lap/shoulder belt or a lap belt for more than one person, no matter what their size.

Lap/Shoulder Belt Operating Instructions

1. Enter the vehicle and close the door. Sit back and adjust the front seat.
2. The seat belt latch plate is above the back of your seat. Grasp the latch plate and pull out the belt. Slide the latch plate up the webbing as far as necessary to make the belt go around your lap.

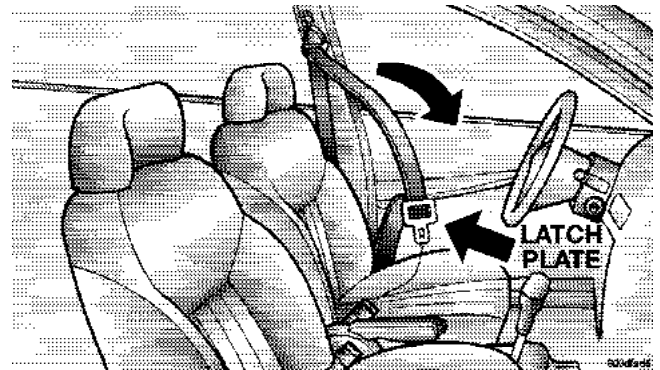
2

Pulling Out Lap/Shoulder Belt

32 THINGS TO KNOW BEFORE STARTING YOUR VEHICLE

3. When the belt is long enough to fit, insert the latch plate into the buckle until you hear a "click."

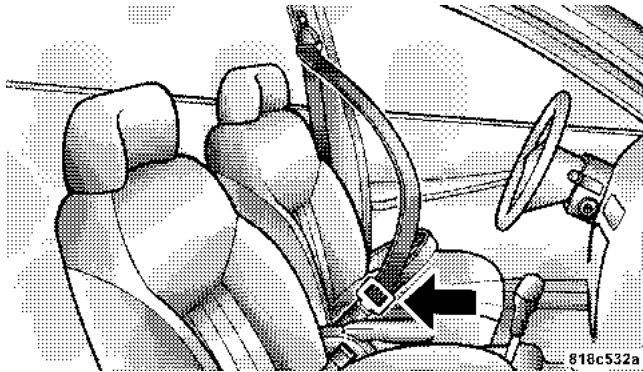

Connecting Latch Plate To Buckle

WARNING!

- A belt that is buckled into the wrong buckle will not protect you properly. The lap portion could ride too high on your body, possibly causing internal injuries. Always buckle your belt into the buckle nearest you.
- A belt that is too loose will not protect you as well. In a sudden stop, you could move too far forward, increasing the possibility of injury. Wear your seat belt snugly.
- A belt that is worn under your arm is very dangerous. Your body could strike the inside surfaces of the vehicle in a collision, increasing head and neck injury. A belt worn under the arm can cause internal injuries. Ribs aren't as strong as shoulder bones. Wear the belt over your shoulder so that your strongest bones will take the force in a collision.
- A shoulder belt placed behind you will not protect you from injury during a collision. You are more likely to hit your head in a collision if you do not wear your shoulder belt. The lap and shoulder belt are meant to be used together.

4. Position the lap belt across your thighs, below your abdomen. To remove slack in the lap belt portion, pull up a bit on the shoulder belt. To loosen the lap belt if it is too tight, tilt the latch plate and pull on the lap belt. A snug belt reduces the risk of sliding under the belt in a collision.

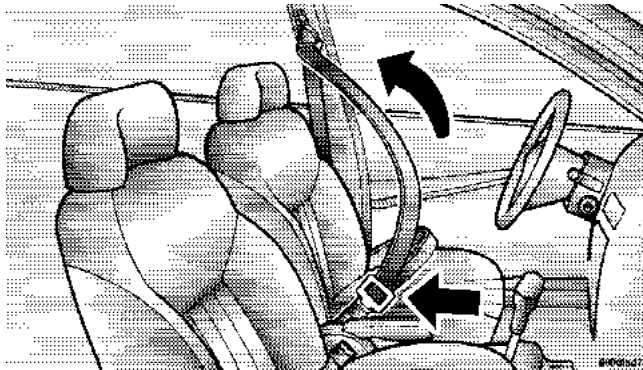

Removing Slack From Belt

WARNING!

- A lap belt worn too high can increase the risk of internal injury in a collision. The belt forces won't be at the strong hip and pelvic bones, but across your abdomen. Always wear the lap belt as low as possible and keep it snug.
- A twisted belt can't do its job as well. In a collision, it could even cut into you. Be sure the belt is straight. If you can't straighten a belt in your vehicle, take it to your dealer and have it fixed.

5. Position the shoulder belt on your chest so that it is comfortable and not resting on your neck. The retractor will withdraw any slack in the belt.

6. To release the belt, push the red button on the buckle. The belt will automatically retract to its stowed position. If necessary, slide the latch plate down the webbing to allow the belt to retract fully.

WARNING!

A frayed or torn belt could rip apart in a collision and leave you with no protection. Inspect the belt system periodically, checking for cuts, frays, or loose parts. Damaged parts must be replaced immediately. Do not disassemble or modify the system. Seat belt assemblies must be replaced after a collision if they have been damaged (bent retractor, torn webbing, etc.).

Adjustable Upper Shoulder Belt Anchorage

In the driver and front passenger seats, the shoulder belt can be adjusted upward or downward to position the belt away from your neck. Push and fully depress the button above the webbing to release the anchorage, and then move it up or down to the position that serves you best.

NOTE: When the shoulder belt is adjusted to the full downward position, it will not be at the bottom of the slot in the Trim Panel. This is normal, and the intended lowest position.

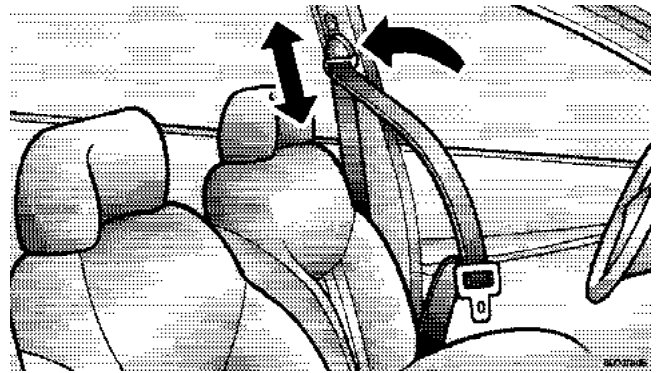
**Adjusting Upper Shoulder Belt**

As a guide, if you are shorter than average, you will prefer a lower position, and if you are taller than average, you will prefer a higher position. When you release the anchorage, try to move it up and down to make sure that it is locked in position.

In the rear seat, move toward the center of the seat to position the belt away from your neck.

Lap/Shoulder Belt Untwisting Procedure

Use the following procedure to untwist a twisted lap/shoulder belt.

1. Position the latch plate as close as possible to the anchor point.
2. At about 6 to 12 inches (15 to 30 cm) above the latch plate, grasp and twist the belt webbing 180° to create a fold that begins immediately above the latch plate.
3. Slide the latch plate upward over the folded webbing. The folded webbing must enter the slot at the top of the latch plate.
4. Continue to slide the latch plate up until it clears the folded webbing.

Seat Belt Pretensioners

The seat belts for both front seating positions are equipped with pretensioning devices that are designed to remove any slack from the seat belts in the event of a collision. These devices improve the performance of the seat belt system by assuring that the belt is tight about the occupant in a collision. Pretensioners work for all size occupants, including those in child restraints.

NOTE: These devices are not a substitute for proper seat belt placement by the occupant. The seat belt still must be worn snugly and positioned properly.

The pretensioners are triggered by the Airbag Control Module (refer to information on Airbags in this section). Like the front airbags, the pretensioners are single use items. After a collision that is severe enough to deploy the airbags and pretensioners, both must be replaced.

Enhanced Seat Belt Reminder System (BeltAlert)

If the driver's seat belt has not been buckled within 60 seconds of starting the vehicle and if the vehicle speed is greater than 5 mph (8 km/h), the Enhanced Warning System (BeltAlert) will alert the driver to buckle their seat belt. The driver should also instruct all other occupants to buckle their seat belts. Once the warning is triggered, the Enhanced Warning System (BeltAlert) will continue to chime and flash the Seat Belt Reminder Light for 96 seconds or until the driver's seat belt is buckled. The Enhanced Warning System (BeltAlert) will be reactivated if the driver's seat belt is unbuckled for more than 10 seconds and the vehicle speed is greater than 5 mph (8 km/h).

BeltAlert Programming

The Enhanced Warning System (BeltAlert) can be enabled or disabled by your authorized dealer or by performing the following steps:

NOTE: DaimlerChrysler does not recommend deactivating the Enhanced Warning System (BeltAlert).

1. With all doors closed, and the ignition switch in any position except ON or START, buckle the driver's seat belt.
2. Turn the ignition switch to the ON/ RUN position, but do not start the engine. Wait for the Seat Belt Reminder Light to turn off and then proceed to the next step.

NOTE: You must perform the following steps within 60 seconds of turning the ignition switch to the ON/ RUN position.

3. Within 60 seconds of turning the ignition switch to the ON/ RUN position, unbuckle and then re-buckle the driver's seat belt at least three times within 10 seconds, ending with the seat belt buckled.

NOTE: Watch for the Seat Belt Reminder Light to turn on while unbuckling the seat belt and turn off while re-buckling the seat belt. It may be necessary to retract the seat belt.

4. Turn the ignition switch to the LOCK position. A single chime will sound to signify that you have successfully completed the programming.

The Enhanced Warning System (BeltAlert) can be reactivated by repeating this procedure.

NOTE: When the Enhanced Warning System (BeltAlert) is deactivated, the Seat Belt Reminder Light will continue to illuminate as long as the driver's seat belt is unbuckled.

Automatic Locking Mode — If Equipped

In this mode, the shoulder belt is automatically pre-locked. However, the belt will still retract to remove slack in the shoulder belt. Use The Automatic Locking Mode any time a child safety seat is installed in a seating position that has a seat belt with this feature. Seat belts that have the Automatic Locking Mode feature have a

distinctive label on the webbing. Children 12 years old and under should be properly restrained in the rear seat whenever possible.

How To Engage The Automatic Locking Mode

1. Buckle the combination lap and shoulder belt.
2. Grasp the shoulder portion and pull downward until the entire belt is extracted.
3. Allow the belt to retract. As the belt retracts, you will here a clicking sound. This indicates the safety belt is now in the automatic locking mode.

How To Disengage The Automatic Locking Mode

Unbuckle the combination lap and shoulder belt and allow it to retract completely to disengage the automatic locking mode and activate the vehicle sensitive (emergency) locking mode.

Seat Belts and Pregnant Women

We recommend that pregnant women use the seat belts throughout their pregnancy. Keeping the mother safe is the best way to keep the baby safe.

Pregnant women should wear the lap part of the belt across the thighs and as snug across the hips as possible. Keep the belt low so that it does not come across the abdomen. That way the strong bones of the hips will take the force if there is a collision.

Seat Belt Extender

If a seat belt is too short, even when fully extended, and when the adjustable upper shoulder belt anchorage (if so equipped) is in its lowest position, your dealer can provide you with a seat belt extender. This extender should be used only if the existing belt is not long enough. When it is not required, remove the extender, and store it.

WARNING!

Using a seat belt extender when not needed can increase the risk of injury in a collision. Only use when the seat belt is not long enough when it is worn low and snug, and in the recommended seating positions. Remove and store the extender when not needed.

Driver and Front Passenger Supplemental Restraint System (SRS) - Airbag

This vehicle has front airbags for both the driver and front passenger as a supplement to the seat belt restraint systems. The driver's airbag is mounted in the center of the steering wheel. The passenger's front airbag is mounted in the instrument panel, above the glove compartment. The words SRS AIRBAG are embossed on the airbag covers.

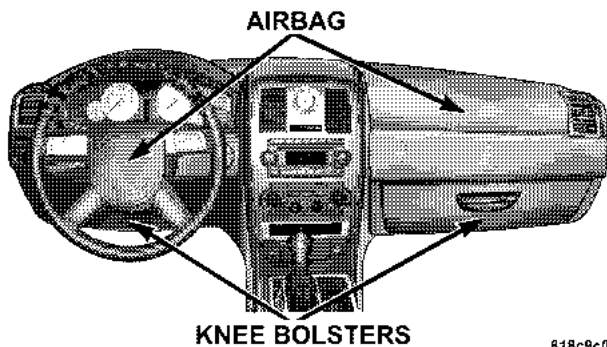

Front Airbag Components

NOTE: The front airbags are certified to the Federal regulations that allow less forceful deployment.

The front airbags have a multistage inflator design. This may allow the airbag to have different rates of inflation that are based on collision severity.

This vehicle may also be equipped with side curtain airbags to protect the driver and passengers sitting next to a window. If the vehicle is equipped with side curtain airbags, they are located above the side windows. Their covers are also labeled SRS AIRBAG.

818c9c09

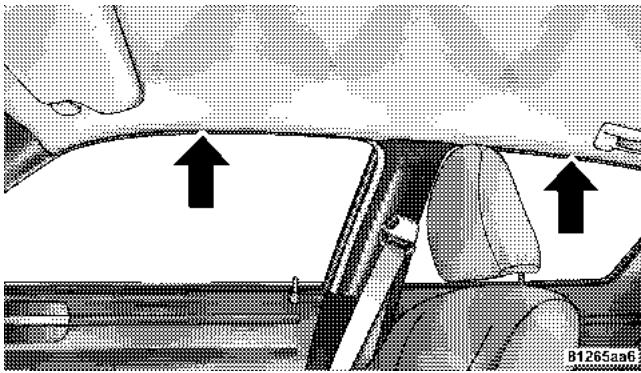

Window Airbag

NOTE: Airbag covers may not be obvious in the interior trim; but they will open to allow airbag deployment.

WARNING!

- Do not put anything on or around the front airbag covers or attempt to manually open them. You may damage the airbags and you could be injured because the airbags are no longer functional. These protective covers for the airbag cushions are designed to open only when the airbags are inflating.
- If your vehicle is equipped with side curtain airbags, do not stack luggage or other cargo up high enough to block the location of the side curtain airbag. The area where the side curtain airbag is located should remain free from any obstructions.
- If your vehicle is equipped with side curtain airbags, do not have any accessory items installed which will alter the roof, including adding a sunroof to your vehicle. Do not add roof racks that require permanent attachments (bolts or screws) for installation on the vehicle roof. Do not drill into the roof of the vehicle for any reason.
- Do not drill, cut or tamper with the knee bolster in any way.
- Do not mount any accessories to the knee bolster such as alarm lights, stereos, citizens band radios etc.

40 THINGS TO KNOW BEFORE STARTING YOUR VEHICLE

NOTE: Do not use a clothing bar mounted to the coat hooks in this vehicle. A clothing bar will impede the proper performance of the curtain airbags.

Along with the seat belts, front airbags work with the instrument panel knee bolsters to provide improved protection for the driver and front passenger. Side Curtain Airbags also work with seat belts to improve occupant protection.

The seat belts are designed to protect you in many types of collisions. The front airbags deploy in moderate to severe frontal collisions.

If your vehicle is so equipped, the Side Curtain Airbag on the crash side of the vehicle is triggered in moderate to severe side collisions. However, even in collisions where the airbags deploy, you need the seat belts to keep you in the correct position for the airbags to protect you properly.

Here are some simple steps you can take to minimize the risk of harm from a deploying airbag.

1. Children 12 years old and under should ride buckled up in the rear seat.

2. Infants in rear-facing child restraints should **NEVER** ride in the front seat of a vehicle with a passenger front airbag. An airbag deployment could cause severe injury or death to infants in that position.

3. Children that are not big enough to wear the vehicle seat belt properly (refer to information on Child Restraint in this section) should be secured in the rear seat in child restraints or belt-positioning booster seats.

4. Older children who do not use child restraints or belt-positioning booster seats should ride properly buckled up in the rear seat. Never allow children to slide the shoulder belt behind them or under their arm.

5. If a child from 1 to 12 years old must ride in the front passenger seat because the vehicle is crowded, move the seat as far back as possible, and use the proper child restraint (refer to information on Child Restraint in this section).

6. You should read the instructions provided with your child restraint to make sure that you are using it properly.

7. All occupants should use their seat belts properly.

8. The driver and front passenger seats should be moved back as far as practical to allow the airbags time to inflate.
9. If your vehicle has side curtain airbags do not lean against the door, airbags will inflate forcefully into the space between you and the door.
10. If the airbag system in this vehicle needs to be modified to accommodate a disabled person, contact the Customer Center. Phone numbers are provided in the "If You Need Customer Assistance" section in this manual.

WARNING!

- **Relying on the airbags alone could lead to more severe injuries in a collision. The airbags work with your seat belt to restrain you properly. In some collisions, the airbags won't deploy at all. Always wear your seat belts even though you have airbags.**
- **Being too close to the steering wheel or instrument panel during airbag deployment could cause serious injury. Airbags need room to inflate. Sit back, comfortably extending your arms to reach the steering wheel or instrument panel.**
- **If the vehicle has side curtain airbags, they also need room to inflate. Do not lean against the door or window. Sit upright in the center of the seat.**

2**Air Bag System Components**

The airbag system consists of the following:

- Airbag Control Module (ACM)
- Side Remote Acceleration Sensors (if equipped)

42 THINGS TO KNOW BEFORE STARTING YOUR VEHICLE

- Airbag Warning Light
- Driver Airbag
- Front Passenger Airbag
- Supplemental Side Curtain Airbags above Side Windows (if equipped)
- Steering Wheel and Column
- Instrument Panel
- Interconnecting Wiring
- Seatbelt Reminder Light
- Knee Impact Bolsters
- Front Acceleration Sensors
- Driver and Front Passenger Seat Belt Pretensioners

How The Airbag System Works

- The **Airbag Control Module (ACM)** determines if a frontal collision is severe enough to require the airbags to inflate. The front airbag inflators are designed to

provide different rates of airbag inflation from direction provided by the ACM. The ACM will not detect roll over.

- The ACM also monitors the readiness of the electronic parts of the system whenever the ignition switch is in the START or ON positions. These include all of the items listed above except the knee bolster, the instrument panel, and the steering wheel and column. If the key is in the LOCK position, in the ACC position, or not in the ignition, the airbags are not on and will not inflate.



- The ACM also turns on the Airbag Warning Light in the instrument panel for 6 to 8 seconds as a self-check when the ignition is first turned on. After the self-check, the Airbag Warning Light will turn off. If the ACM detects a malfunction in any part of the system, it turns on the Airbag Warning Light either momentarily or continuously. A single chime will sound if the light comes on again after initial start up.

WARNING!

Ignoring the AIRBAG Warning Light in your instrument panel could mean you won't have the airbags to protect you in a collision. If the light does not come on, stays on after you start the vehicle, or if it comes on as you drive, have the airbag system checked right away.

- The **Driver and Front Passenger Airbag/Inflator Units** are located in the center of the steering wheel and the passenger side of the instrument panel. When the ACM detects a collision requiring the airbags, it signals the inflator units. A large quantity of nontoxic gas is generated to inflate the front airbags. Different airbag inflation rates may be possible based on collision severity. The steering wheel hub trim cover, and the upper passenger side of the instrument panel separate and fold out of the way, as the bags inflate to their full size. The bags fully inflate in about 50 - 70 milliseconds. This is about half of the time that it takes to blink your eyes. The bags then quickly deflate while helping to restrain the driver and front passenger. The

driver's front airbag gas is vented through vent holes in the sides of the airbag. The passenger's front airbag gas is vented through vent holes in the sides of the airbag. In this way, the airbags do not interfere with your control of the vehicle.

- The **Side Impact SRS Side Curtain Airbag** are designed to activate only in certain side collisions. When the ACM (with side impact option) detects a collision requiring the side curtain airbag to inflate, it signals the inflators on the crash side of the vehicle. A quantity of nontoxic gas is generated to inflate the side curtain airbag. The inflating side curtain airbag pushes the outside edge of the headliner out of the way and covers the window. The airbag inflates in about 30 milliseconds (about one quarter of the time that it takes to blink your eyes) with enough force to injure you if you are not belted and seated properly, or if items are positioned in the area where the side curtain airbag inflates. This especially applies to children. The side curtain airbag is only about 3-1/2 inches (9 cm) thick when it is inflated.

- The **Knee Impact Bolsters** help protect the knees of the driver and the front passenger, and position everyone for the best interaction with the front airbag.

If A Deployment Occurs

The airbag system is designed to deploy when the ACM detects a moderate-to-severe collision, to help restrain the driver and front passenger, and then to immediately deflate.

NOTE: A frontal collision that is not severe enough to need airbag protection will not activate the system. This does not mean something is wrong with the airbag system.

If you do have a collision, which deploys the airbags, any or all of the following may occur:

- The nylon airbag material may sometimes cause abrasions and/or skin reddening to the driver and front passenger as the airbags deploy and unfold. The abrasions are similar to friction rope burns or those you might get sliding along a carpet or gymnasium floor. They are not caused by contact with chemicals. They are not permanent and normally heal quickly.

However, if you haven't healed significantly within a few days, or if you have any blistering, see your doctor immediately.

- As the airbags deflate, you may see some smoke-like particles. The particles are a normal by-product of the process that generates the nontoxic gas used for airbag inflation. These airborne particles may irritate the skin, eyes, nose, or throat. If you have skin or eye irritation, rinse the area with cool water. For nose or throat irritation, move to fresh air. If the irritation continues, see your doctor. If these particles settle on your clothing, follow the garment manufacturer's instructions for cleaning.
- It is not advisable to drive your vehicle after the airbags have been deployed. If you are involved in another collision, the airbags will not be in place to protect you.

WARNING!

Deployed airbags can't protect you in another collision. Have the airbags replaced by an authorized dealer as soon as possible.

Enhanced Accident Response Feature

If the airbags deploy after an impact and the electrical system remains functional, vehicles equipped with power door locks will unlock automatically. In addition, approximately 5 seconds after the vehicle has stopped moving, the interior lights will illuminate to aid visibility.

NOTE: The interior lights can only be deactivated if the key is removed from the ignition switch or the vehicle is driven.

Maintaining Your Airbag System**WARNING!**

- Modifications to any part of the airbag system could cause it to fail when you need it. You could be injured because the airbags are not there to protect you. Do not modify the components or wiring, including adding any kind of badges or stickers to the steering wheel hub trim cover or the upper passenger side of the instrument panel. Do not modify the front bumper, vehicle body structure, or frame.
- You need proper knee impact protection in a collision. Do not mount or locate any aftermarket equipment on or behind the knee impact bolster.
- It is dangerous to try to repair any part of the airbag system yourself. Be sure to tell anyone who works on your vehicle that it has airbags.

Airbag Warning Light



You will want to have the airbags ready to inflate for your protection in an impact. While the airbag system is designed to be maintenance free, if any of the following occurs, have an authorized dealer service the system promptly:

- The Airbag Warning Light does not come on or flickers during the 6 to 8 seconds when the ignition switch is first turned on.
- The light remains on or flickers after the 6 to 8 second interval.
- The light flickers or comes on and remains on while driving.

Event Data Recorder (EDR)

In the event of an airbag deployment, your vehicle is designed to record up to 2-seconds of specific vehicle data parameters (see list below) in an event data recorder prior to the moment of airbag deployment. Please note that such data are ONLY recorded if an airbag deploys, and are otherwise unavailable. In conjunction with other data gathered during a complete accident investigation,

the electronic data may be used by DaimlerChrysler and others to learn more about the possible causes of crashes and associated injuries in order to assess and improve vehicle performance. In addition to crash investigations initiated by DaimlerChrysler, such investigations may be requested by customers, insurance carriers, government officials, and professional crash researchers, such as those associated with universities, and with hospital and insurance organizations.

In the event that an investigation is undertaken by DaimlerChrysler (regardless of initiative), the company or its designated representative will first obtain permission of the appropriate custodial entity for the vehicle (usually the vehicle owner or lessee) before accessing the electronic data stored, unless ordered to download data by a court with legal jurisdiction (i.e., pursuant to a warrant). A copy of the data will be provided to the custodial entity upon request. General data that does not identify particular vehicles or crashes may be released for incorporation in aggregate crash databases, such as those maintained by the US government and various states. Data of a potentially sensitive nature, such as would identify a particular driver, vehicle, or crash, will be

treated confidentially. Confidential data will not be disclosed by DaimlerChrysler to any third party except when:

1. Used for research purposes, such as to match data with a particular crash record in an aggregate database, provided confidentiality of personal data is thereafter preserved
2. Used in defense of litigation involving a DaimlerChrysler product
3. Requested by police under a legal warrant
4. Otherwise required by law

Data Parameters that May Be Recorded:

- Diagnostic trouble code(s) and warning light status for electronically controlled safety systems, including the airbag system
- "Time" of airbag deployment (in terms of ignition cycles and vehicle mileage)
- Airbag deployment level (if applicable)
- Seatbelt status

- Brake status (service and parking brakes)
- Accelerator status (including vehicle speed)
- Engine control status (including engine speed)
- Cruise control status (if applicable)
- Traction/stability control status (if applicable)

Child Restraint

Everyone in your vehicle needs to be buckled up all the time — babies and children, too. Every state in the United States and all Canadian provinces require that small children ride in proper restraint systems. This is the law, and you can be prosecuted for ignoring it.

Children 12 years and under should ride properly buckled up in a rear seat, if available. According to crash statistics, children are safer when properly restrained in the rear seats rather than in the front.

WARNING!

In a collision, an unrestrained child, even a tiny baby, can become a missile inside the vehicle. The force required to hold even an infant on your lap could become so great that you could not hold the child, no matter how strong you are. The child and others could be badly injured. Any child riding in your vehicle should be in a proper restraint for the child's size.

There are different sizes and types of restraints for children from newborn size to the child almost large enough for an adult safety belt. Always check the child seat Owner's Manual to ensure you have the correct seat for your child. Use the restraint that is correct for your child:

Infants and Child Restraints

- Safety experts recommend that children ride rearward-facing in the vehicle until they are at least one year old **and** weigh at least 20 lbs (9 kg). Two types of child restraints can be used rearward-facing: infant carriers and "convertible" child seats.
- The infant carrier is only used rearward-facing in the vehicle. It is recommended for children who weigh up to about 20 lbs (9 kg). "Convertible" child seats can be used either rearward-facing or forward-facing in the vehicle. Convertible child seats often have a higher weight limit in the rearward-facing direction than infant carriers do, so they can be used rearward-facing by children who weigh more than 20 lbs (9 kg) but are less than one year old. Both types of child restraints are held in the vehicle by the lap/shoulder belt or the LATCH child restraint anchorage system. Refer to "LATCH — Child Seat Anchorage System (Lower Anchors and Tether for Children)" in this section.
- Rearward-facing child seats must **NEVER** be used in the front seat of a vehicle with the front passenger airbag unless the airbag is turned off. An airbag deployment could cause severe injury or death to infants in this position.

Older Children and Child Restraints

Children who weigh more than 20 lbs (9 kg) and who are older than one year can ride forward-facing in the vehicle. Forward-facing child seats and convertible child seats used in the forward-facing direction are for children who weigh 20 to 40 lbs (9 to 18 kg) and who are older than one year. These child seats are also held in the vehicle by the lap/shoulder belt or the LATCH child restraint anchorage system. Refer to “LATCH — Child Seat Anchorage System (Lower Anchors and Tether for Children)” in this section.

The belt-positioning booster seat is for children weighing more than 40 lbs (18 kg), but who are still too small to fit the vehicle’s seat belts properly. If the child cannot sit with knees bent over the vehicle’s seat cushion while the child’s back is against the seat back, they should use a belt-positioning booster seat. The child and belt-positioning booster seat are held in the vehicle by the lap/shoulder belt.

Children Too Large For Booster Seats

Children who are large enough to wear the shoulder belt comfortably, and whose legs are long enough to bend over the front of the seat when their back is against the seat back, should use the lap/shoulder belt in a rear seat.

- Make sure that the child is upright in the seat.
- The lap portion should be low on the hips and as snug as possible.
- Check belt fit periodically. A child’s squirming or slouching can move the belt out of position.
- If the shoulder belt contacts the face or neck, move the child closer to the center of the vehicle. Never allow a child to put the shoulder belt under an arm or behind their back.

NOTE: For additional information, refer to www.seatcheck.org or call 1-866-SEATCHECK.

WARNING!

- **Improper installation can lead to failure of an infant or child restraint. It could come loose in a collision. The child could be badly injured or killed. Follow the manufacturer's directions exactly when installing an infant or child restraint.**
- **A rearward facing child restraint should only be used in a rear seat. A rearward facing child restraint in the front seat may be struck by a deploying passenger airbag, which may cause severe or fatal injury to the infant.**

Here are some tips on getting the most out of your child restraint:

- Before buying any restraint system, make sure that it has a label certifying that it meets all applicable Safety Standards. We also recommend that you make sure that you can install the child restraint in the vehicle where you will use it before you buy it.

- The restraint must be appropriate for your child's weight and height. Check the label on the restraint for weight and height limits.
- Carefully follow the instructions that come with the restraint. If you install the restraint improperly, it may not work when you need it.
- Buckle the child into the seat according to the child restraint manufacturer's directions.
- When your child restraint is not in use, secure it in the vehicle with the seat belt or remove it from the vehicle. Do not leave it loose in the vehicle. In a sudden stop or collision, it could strike the occupants or seat backs and cause serious personal injury.

LATCH — Child Seat Anchorage System (Lower Anchors and Tether for Children)

Your vehicle's rear seat is equipped with the child restraint anchorage system called LATCH. The LATCH system provides for the installation of the child restraint without using the vehicle's seat belts, instead securing

the child restraint using lower anchorages and upper tether straps from the child restraint to the vehicle structure.

LATCH-compatible child restraint systems are now available. However, because the lower anchorages are to be introduced over a period of years, child restraint systems having attachments for those anchorages will continue to have features for installation using the vehicle's seat belts. Child restraints having tether straps and hooks for connection to the top tether anchorages have been available for some time. For some older child restraints, many child restraint manufacturers offer add-on tether strap kits or retrofit kits. You are urged to take advantage of all the available attachments provided with your child restraint in any vehicle.

All three rear-seating positions have lower anchorages that are capable of accommodating LATCH-compatible child seats. You should **NEVER** install LATCH-compatible child seats such that two seats share a common lower anchorage. If installing child seats in adjacent rear-seating positions, or if your child restraints are not LATCH-compatible, install the restraints using the vehicle's seat belts.

2



LATCH Anchorages

Installing the LATCH-Compatible Child Restraint System

We urge that you carefully follow the directions of the manufacturer when installing your child restraint. Not all child restraint systems will be installed as described here. Again, carefully follow the installation instructions that were provided with the child restraint system.



The rear seat lower anchorages are round bars, located at the rear of the seat cushion where it meets the seat back, and are just visible when you lean into the rear seat to install the child restraint. You will easily feel them if you run your finger along the intersection of the seatback and seat cushion surfaces.



In addition, there are tether strap anchorages behind each rear seating position located in the panel between the rear seat back and the rear window. These tether strap anchorages are under a plastic cover with this symbol on it.

Many, but not all restraint systems will be equipped with separate straps on each side, with each having a hook or connector for attachment to the lower anchorage and a

means of adjusting the tension in the strap. Forward-facing toddler restraints and some rear-facing infant restraints will also be equipped with a tether strap, a hook for attachment to the tether strap anchorage and a means of adjusting the tension of the strap.

You will first loosen the adjusters on the lower straps and on the tether strap so that you can more easily attach the hooks or connectors to the vehicle anchorages. Next, attach the lower hooks or connectors over the top of the seat cover material. Then rotate the tether anchorage cover directly behind the seat where you are placing the child restraint and attach the tether strap to the anchorage, being careful to route the tether strap to provide the most direct path between the anchor and the child restraint. Finally, tighten all three straps as you push the child restraint rearward and downward into the seat, removing slack in the straps according to the child restraint manufacturer's instructions.

NOTE:

- Ensure that the tether strap does not slip into the opening between the seat backs as you remove slack in the strap.

- When using the LATCH attaching system to install a child restraint, please ensure that all seat belts not being used for occupant restraints are stowed and out of reach of children. It is recommended that before installing the child restraint, buckle the seat belt so the seat belt is tucked behind the child restraint and out of reach. If the buckled seat belt interferes with the child restraint installation, instead of tucking the seat belt behind the child restraint, route the seat belt through the child restraint belt path and then buckle it. This should stow the seat belt out of the reach of an inquisitive child. Remind all children in the vehicle that the seat belts are not toys and should not be played with, and never leave your child unattended in the vehicle.

WARNING!

Improper installation of a child restraint to the LATCH anchorages can lead to failure of an infant or child restraint. The child could be badly injured or killed. Follow the manufacturer's directions exactly when installing an infant or child restraint.

2**Installing Child Restraints Using the Vehicle Seat belt**

The passenger seat belts are equipped with either cinching latch plates or automatic locking retractors, which are designed to keep the lap portion tight around the child restraint so that it is not necessary to use a locking clip. Pulling up on the shoulder portion of the lap/shoulder belt will tighten the belt. The cinching latch plate will keep the belt tight, however, any seat belt system will loosen with time, so check the belt occasionally, and pull it tight if necessary.

Seat belts with an automatic locking retractor have a distinctive label on the seat belt webbing. The seat belt must be in the automatic locking mode in order to enable

a child restraint to be tightly installed. Refer to “Automatic Locking Mode” in this section for details. A locking clip should not be necessary once the automatic locking feature is enabled. Position the shoulder and lap belt on the child restraint. The automatic locking retractor is activated by first attaching the child seat, then pulling all of the webbing out of the retractor, then allowing back in. Tighten webbing. To release, simply unbuckle the seat belt by depressing the button, allowing the webbing to retract into the retractor.

In the rear seat, you may have trouble tightening the lap/shoulder belt on the child restraint because the buckle or latch plate is too close to the belt path opening on the restraint. Disconnect the latch plate from the buckle and twist the short buckle-end belt several times to shorten it. Insert the latch plate into the buckle with the release button facing out.

If the belt still can’t be tightened, or if by pulling and pushing on the restraint loosens the belt, you may need to do something more. Disconnect the latch plate from the buckle, turn the buckle around, and insert the latch

plate into the buckle again. If you still can’t make the child restraint secure, try a different seating position.

To attach a child restraint tether strap:

1. Rotate the cover over the anchor directly behind the seat where you are placing the child restraint.

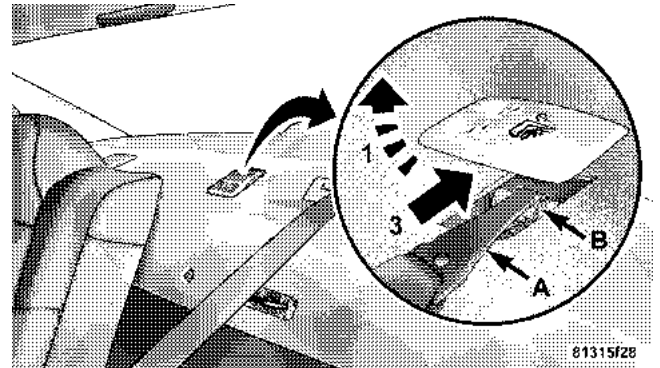

Tether Strap Mounting

2. Route the tether strap to provide the most direct path for the strap between the anchor and the child seat.

3. Attach the tether strap hook (A) of the child restraint to the anchor (B) and remove slack in the tether strap according to the child restraint manufacturer's instructions.

NOTE: Ensure that the tether strap does not slip into the opening between the seat backs as you remove slack in the strap.

WARNING!

An incorrectly anchored tether strap could lead to increased head motion and possible injury to the child. Use only the anchor positions directly behind the child seat to secure a child restraint top tether strap.

Transporting Pets

Airbags deploying in the front seat could harm your pet. An unrestrained pet will be thrown about and possibly injured, or injure a passenger during panic braking or in a collision.

Pets should be restrained in the rear seat in pet harnesses or pet carriers that are secured by seat belts.

BREAK-IN RECOMMENDATIONS

A long break-in period is not required for the drivetrain (engine, transmission, and rear axle) in your new vehicle.

Drive moderately during the first 500 miles (800 km). After the initial 60 miles (100 km), speeds up to 50 or 55 mph (80 or 90 km/h) are desirable.

While cruising, brief full-throttle acceleration, within the limits of local traffic laws, contributes to a good break-in. However, wide-open throttle acceleration in low gear can be detrimental and should be avoided.

The engine oil, transmission fluid, and axle lubricant installed at the factory is high quality and energy conserving. Oil, fluid, and lubricant changes should be consistent with anticipated climate and conditions under which vehicle operations will occur. The recommended viscosity and quality grades is shown in Section 7 of this manual.

CAUTION!

Never use Non-Detergent Oil or Straight Mineral Oil in the engine or damage may result.

NOTE: A new engine may consume some oil during its first few thousand miles (kilometers) of operation. This should be considered as a normal part of the break-in and not interpreted as an indication of difficulty.

SAFETY TIPS**Transporting Passengers**

NEVER TRANSPORT PASSENGERS IN THE CARGO AREA.

WARNING!

It is extremely dangerous to ride in a cargo area, inside or outside of a vehicle. In a collision, people riding in these areas are more likely to be seriously injured or killed.

Do not allow people to ride in any area of your vehicle that is not equipped with seats and seat belts.

Be sure everyone in your vehicle is in a seat and using a seat belt properly.

Lock Your Vehicle

Always remove the keys from the ignition and lock all doors when leaving the vehicle unattended, even in your own driveway or garage. Try to park your vehicle in a well-lit area and never invite theft by leaving articles of value exposed.

Exhaust Gas

Do not run the engine in a closed garage or in confined areas any longer than needed to move your vehicle in or out of the area.

If it is necessary to sit in a parked vehicle with the engine running, adjust your heating or cooling controls to force outside air into the vehicle. Set the blower at high speed.

The best protection against carbon monoxide entry into the vehicle body is a properly maintained engine exhaust system.

Whenever a change is noticed in the sound of the exhaust system, when exhaust fumes can be detected inside the vehicle, or when the underside or rear of the vehicle is damaged, have a competent mechanic inspect the complete exhaust system and adjacent body areas for broken, damaged, deteriorated, or mispositioned parts. Open seams or loose connections could permit exhaust fumes to seep into the passenger compartment. In addition, inspect the exhaust system each time the vehicle is raised for lubrication or oil change. Replace as required.

WARNING!

- Exhaust gases can injure or kill. They contain carbon monoxide (CO) which is colorless and odorless. Breathing it can make you unconscious and can eventually poison you. To avoid breathing (CO) follow the safety tips below.
- If you are required to drive with the trunk open, make sure that all windows are closed, and the climate control blower switch is set at high speed. **DO NOT** use the recirculation mode.

2

Safety Checks You Should Make Inside The Vehicle

Seat Belts

Inspect the belt system periodically, checking for cuts, frays, and loose parts. Damaged parts must be replaced immediately. Do not disassemble or modify the system.

Front seat belt assemblies must be replaced after a collision. Rear seat belt assemblies must be replaced after a collision if they have been damaged (bent retractor, torn webbing, etc. If there is any question regarding belt or retractor condition, replace the belt.

Airbag Warning Light

The light should come on and remain on for 6 to 8 seconds as a bulb check when the ignition switch is first turned ON. If the light is not lit during starting, see your authorized dealer. If the light stays on, flickers, or comes on while driving, have the system checked by an authorized dealer.

Defroster

Check operation by selecting the defrost mode and place the blower control on high speed. You should be able to feel the air directed against the windshield.

Periodic Safety Checks You Should Make Outside The Vehicle

Tires

Examine tires for excessive tread wear and uneven wear patterns. Check for stones, nails, glass, or other objects lodged in the tread. Inspect the tread and sidewall for cuts and cracks. Check the wheel nuts for tightness. Check the tires (including spare) for proper pressure.

Lights

Have someone observe the operation of exterior lights while you work the controls. Check turn signal and high beam indicator lights on the instrument panel.

Door Latches

Check for positive closing, latching, and locking.

Fluid Leaks

Check area under vehicle after overnight parking for fuel, engine coolant, oil, or other fluid leaks. Also, if gasoline fumes are detected or if fuel, power steering fluid, or brake fluid leaks are suspected, the cause should be located and corrected immediately.

UNDERSTANDING THE FEATURES OF YOUR VEHICLE

CONTENTS

| | | | |
|---|-----|---|-----|
| ■ Mirrors | .63 | □ Operations | .67 |
| □ Automatic Dimming Inside Mirror | .63 | □ Phone Call Features | .73 |
| □ Outside Mirrors | .63 | □ UConnect™ System Features | .75 |
| □ Exterior Mirrors Folding Feature — If Equipped | .64 | □ Advanced Phone Connectivity | .78 |
| □ Driver’s Side Outside Mirror Auto Dimmer | .64 | □ Things You Should Know About Your UConnect™ System | .80 |
| □ Tilt In Reverse Feature | .64 | ■ Seats | .85 |
| □ Power Remote Control Mirrors | .64 | □ Power Seats | .85 |
| □ Heated Remote Control Mirrors | .65 | □ Power Reclining Seats | .86 |
| □ Illuminated Vanity Mirrors | .65 | □ Lumbar Support | .87 |
| ■ Hands-Free Communication (UConnect™) — If Equipped | .66 | □ Head Restraints | .87 |
| | | □ Heated Seats | .87 |

60 UNDERSTANDING THE FEATURES OF YOUR VEHICLE

| | | | |
|---|-----|--|------|
| □ Folding Rear Seat | .89 | □ Lights-On Reminder | .98 |
| ■ Driver Memory Seat — If Equipped | .90 | □ Fog Lights | .98 |
| □ Programming The Memory Feature | .90 | □ Multi-Function Lever | .98 |
| □ Linking & Unlinking The Remote Keyless Transmitter To The Memory Feature | .91 | □ Overhead Console Map/Reading Lights | .99 |
| □ Memory Position Recall | .92 | □ Interior Lights | .100 |
| □ Easy Entry/Exit Seat (Available With Memory Seat Only) | .92 | ■ Windshield Wipers And Washers | .101 |
| ■ To Open And Close The Hood | .93 | □ Intermittent Wiper System | .101 |
| ■ Lights | .95 | □ Mist Feature | .102 |
| □ Headlight Switch | .95 | □ Windshield Washers | .102 |
| □ Automatic Headlights | .95 | □ Headlights On With Wipers | .102 |
| □ Headlights On With Wipers | .96 | □ Rain Sensing Wipers | .102 |
| □ Smartbeams — If Equipped | .96 | □ Adding Washer Fluid | .104 |
| □ Headlight Time Delay | .97 | ■ Headlight Washers | .105 |
| □ Daytime Running Lights (Canada Only) | .98 | □ Adding Washer Fluid | .106 |
| | | ■ Power Tilt/Telescoping Steering Column | .107 |
| | | ■ Adjustable Pedals | .108 |

| | |
|---|---|
| <ul style="list-style-type: none"> ■ Electronic Speed Control 109 <ul style="list-style-type: none"> □ Electronic Speed Control Operation 109 □ To Activate 110 □ To Set At A Desired Speed 110 □ To Deactivate 110 □ To Resume Speed 110 □ To Vary The Speed Setting 111 □ To Accelerate For Passing 111 ■ Rear Park Assist System 112 ■ Overhead Console 115 <ul style="list-style-type: none"> □ Courtesy/Reading Lights 115 □ Sunglasses Storage 115 ■ Garage Door Opener (HomeLink®) 116 <ul style="list-style-type: none"> □ Programming HomeLink 117 □ Canadian Programming/Gate Programming . . 119 □ Using HomeLink 120 | <ul style="list-style-type: none"> □ Erasing HomeLink Buttons 120 □ Reprogramming a Single HomeLink Button . . . 120 □ Security 121 ■ Power Sunroof — If Equipped 121 <ul style="list-style-type: none"> □ Opening Sunroof - Express 122 □ Closing Sunroof - Express 122 □ Pinch Protect Feature 122 □ Pinch Protect Override 123 □ Venting Sunroof - Express 123 □ Sunshade Operation 123 □ Wind Buffeting 123 □ Sunroof Maintenance 123 □ Ignition Off Operation 123 □ Sunroof Fully Closed 124 ■ Electrical Power Outlets 124 <ul style="list-style-type: none"> □ Electrical Outlet Use With Engine Off 125 |
|---|---|

62 UNDERSTANDING THE FEATURES OF YOUR VEHICLE

| | | | |
|------------------------------------|-----|----------------------------------|-----|
| ■ Cup Holders | 126 | ■ Storage | 127 |
| □ Front Seat Cup Holders | 126 | □ Console Features | 127 |
| □ Rear Seat Cup Holders | 126 | □ Cargo Area | 127 |
| | | ■ Load Leveling System | 129 |

MIRRORS

Automatic Dimming Inside Mirror

This mirror automatically adjusts for annoying headlight glare from vehicles behind you. You can turn the feature on or off by pressing the button at the base of the mirror. A light in the button will indicate when the dimming feature is activated.

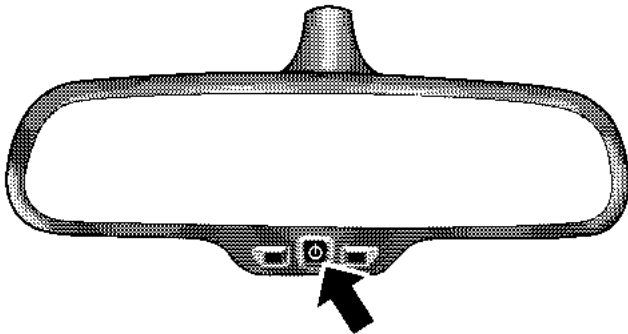

817892c4

Automatic Dimming Mirror

CAUTION!

To avoid damage to the mirror during cleaning, never spray any cleaning solution directly onto the mirror. Apply the solution onto a clean cloth and wipe the mirror clean.

3

Outside Mirrors

To receive maximum benefit, adjust the outside mirror(s) to center on the adjacent lane of traffic and a slight overlap of the view obtained from the inside mirror.

NOTE: The passenger side convex outside mirror will give a much wider view to the rear, and especially of the lane next to your vehicle.

WARNING!

Vehicles and other objects seen in the passenger side convex mirror will look smaller and farther away than they really are. Relying too much on your passenger side convex mirror could cause you to collide with another vehicle or other object. Use your inside mirror when judging the size or distance of a vehicle seen in the passenger side convex mirror.

Exterior Mirrors Folding Feature — If Equipped

Some models have exterior mirrors that are hinged. The hinge allows the mirror to pivot forward and rearward to resist damage. The hinge has three detent positions, full forward, full rearward, and normal.

Driver's Side Outside Mirror Auto Dimmer

This mirror automatically adjusts for annoying headlight glare from vehicles behind you. You can turn this feature on or off by pressing the button at the base of the Inside Rearview Mirror.

Tilt in Reverse Feature

The "Tilt in Reverse" feature tilts the outside rearview mirrors downward when the ignition switch is in the ON position and the transmission is in the R (Reverse) position. This feature provides the driver with a better view of the ground and vehicle in the area of the rear tires when backing up. The mirrors will move back to their previous position when the transmission is shifted out of R (Reverse).

The "Tilt in Reverse" feature can be enabled or disabled. For details, refer to "Tilt Mirrors Down in Reverse," under "Personal Settings (Customer Programmable Features)," under "Electronic Vehicle Information Center (EVIC)" in Section 4 of this manual.

Power Remote Control Mirrors

The power mirror switch is located on the driver's door trim panel next to the power door lock switch. A rotary knob selects the left mirror, right mirror, or off position.

After selecting a mirror, move the knob in the same direction you want the mirror to move. Use the center off position to guard against accidentally moving a mirror position.

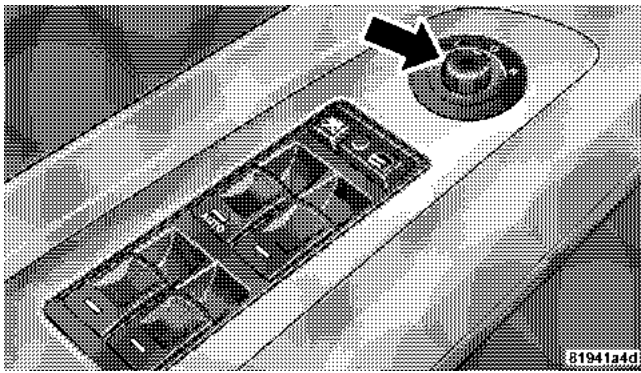

Power Mirror Control

NOTE: For vehicles equipped with Driver Memory Seat, you can use your remote keyless entry transmitter or the memory switch on the driver's door panel to return the power mirrors to pre-programmed positions. Refer to "Driver Memory Seat" in this section for details.

Heated Remote Control Mirrors

These mirrors are heated to melt frost or ice. This feature is activated whenever you turn on the Rear Window Defrost.

Illuminated Vanity Mirrors

An illuminated vanity mirror is on the sun visor. To use the mirror, rotate the sun visor downward and swing the mirror cover upward. The light turns on automatically. Closing the mirror cover turns off the lights.

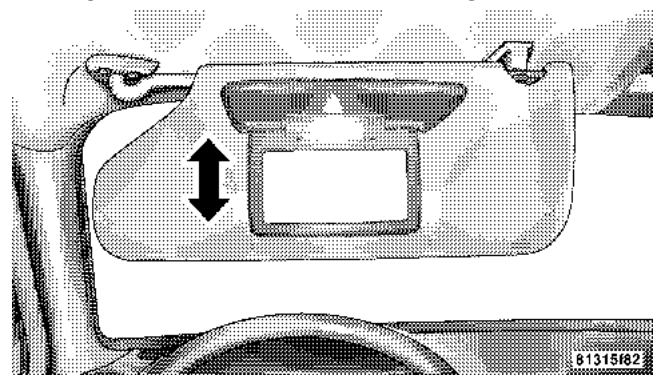

Illuminated Vanity Mirror

HANDS-FREE COMMUNICATION (UConnect™) — IF EQUIPPED

UConnect™ is a voice-activated, hands-free, in-vehicle communications system. UConnect™ allows you to dial a phone number with your cellular phone using simple voice commands (e.g., "Call" ... "Mike" ... "Work" or "Dial" ... "248-555-1212"). Your cellular phone's audio is transmitted through your vehicle's audio system; the system will automatically mute your radio when using the UConnect™ system.

NOTE: The UConnect™ system use requires a cellular phone equipped with the Bluetooth "Hands-Free Profile," version 0.96 or higher. See www.chrysler.com/uconnect for supported phones.

UConnect™ allows you to transfer calls between the system and your cellular phone as you enter or exit your vehicle, and enables you to mute the system's microphone for private conversation.

The UConnect™ phonebook enables you to store up to 32 names and four numbers per name. Each language has a separate 32-name phonebook accessible only in that

language. This system is driven through your Bluetooth™ Hands-Free profile cellular phone. UConnect™ features Bluetooth™ technology - the global standard that enables different electronic devices to connect to each other without wires or a docking station, so UConnect works no matter where you stow your cellular phone (be it your purse, pocket, or briefcase), as long as your phone is turned on and has been paired to the vehicle's UConnect™ system. The UConnect™ system allows up to seven cellular phones to be linked to system. Only one linked (or paired) cellular phone can be used with the system at a time. The system is available in English, Spanish, or French languages (as equipped).

The rearview mirror contains the microphone for the system and the control buttons that will enable you to access the system.

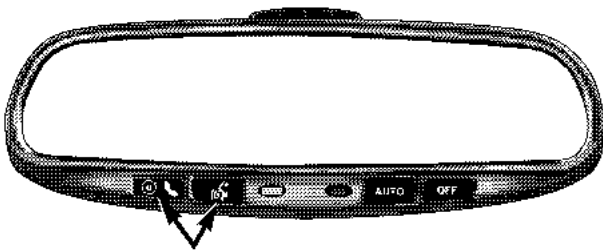

8105b20d

UConnect™ Switches

The UConnect™ system can be used with any Hands-Free Profile certified Bluetooth™ cellular phone. See www.chrysler.com/uconnect for supported phones. If your cellular phone supports a different profile (e.g., Headset Profile), you may not be able to use any UConnect™ features. Refer to your cellular service provider or the phone manufacturer for details.

The UConnect™ system is fully integrated with the vehicle's audio system. The volume of the UConnect™

system can be adjusted either from the radio volume control knob, or from the steering wheel radio control (right switch), if so equipped.

The radio display will be used for visual prompts from the UConnect™ system such as "CELL" or caller ID on certain radios.

3

Operations

Voice commands can be used to operate the UConnect™ system and to navigate through the UConnect™ menu structure. Voice commands are required after most UConnect™ system prompts. You will be prompted for a specific command and then guided through the available options.

- Prior to giving a voice command, one must wait for the voice on beep, which follows the "Ready" prompt or another prompt.
- For certain operations, compound commands can be used. For example, instead of saying "Setup" and then "Phone Pairing," the following compound command can be said: "Setup Phone Pairing."

- For each feature explanation in this section, only the combined form of the voice command is given. You can also break the commands into parts and say each part of the command, when you are asked for it. For example, you can use the combined form voice command "Phonebook New Entry," or you can break the combined form command into two voice commands: "Phonebook" and "New Entry." Please remember, the UConnect™ system works best when you talk in a normal conversational tone, as if speaking to someone sitting eight feet away from you.

Voice Command Tree

Refer to "Voice Tree" at the end of this section.

Help Command

If you need assistance at any prompt, or if you want to know your options are at any prompt, say "Help" following the voice on beep. The UConnect™ system will play all the options at any prompt if you ask for help.

To activate the UConnect™ system from idle, simply press the 'Phone' button and follow audible prompts for directions. All UConnect™ system sessions begin with a press of the 'Phone' button on the mirror.

Cancel Command

At any prompt, after the voice on beep, you can say "Cancel" and you will be returned to the main menu. However, in a few instances the system will take you back to the previous menu.

Pair (Link) UConnect™ System to a Cellular Phone

To begin using your UConnect™ system, you must pair your compatible Bluetooth™ enabled cellular phone.

NOTE: The UConnect™ system use requires a cellular phone equipped with the Bluetooth "Hands-Free Profile," version 0.96 or higher. See www.chrysler.com/uconnect for supported phones.

To complete the pairing process, you will need to reference your cellular phone owner's manual. One of the following vehicle specific websites may also provide detailed instructions for pairing with the brand of phone that you have:

NOTE:

- www.chrysler.com/uconnect
- www.dodge.com/uconnect

- www.jeep.com/uconnect

The following are general phone to UConnect™ System pairing instructions:

- Press the 'Phone' button to begin.
- After the "Ready" prompt and the following beep, say "Setup Phone Pairing" and follow the audible prompts.
- When prompted, after the voice on beep, say "Pair a Phone" and follow the audible prompts.
- You will be asked to say a four-digit pin number, which you will later need to enter into your cellular. You can enter any four-digit pin number. You will not need to remember this pin number after the initial pairing process.
- For identification purposes, you will be prompted to give the UConnect™ system a name for your cellular phone. Each cellular phone that is paired should be given a unique phone name.
- You will then be asked to give your cellular phone a priority level between 1 and 7, 1 being the highest priority. You can pair up to seven cellular phones to

your UConnect™ system. However, at any given time, only one cellular phone can be in use, connected to your UConnect™ System. The priority allows the UConnect™ system to know which cellular phone to use if multiple cellular phones are in the vehicle at the same time. For example, if priority 3 and priority 5 phones are present in the vehicle, the UConnect™ system will use the priority 3 cellular phone when you make a call. You can select to use a lower priority cellular phone at any time (refer to "Advanced Phone Connectivity").

Call/Dial by Saying a Number

- Press the 'Phone' button to begin.
- After the "Ready" prompt and the following beep, say "Dial."
- System will prompt you to say the number you want call.
- For example, you can say "234-567-8901."

- The UConnect™ system will confirm the phone number and then dial. The number will appear in the display of certain radios.

Call/Dial by Saying a Name

- Press the "Phone" button to begin.
- After the "Ready" prompt and the following beep, say "Dial" or Call."
- System will prompt you to say the name of the person you want call.
- After the "Ready" prompt and the following beep, say the name of the person you want to call. For example, you can say "John Doe," where John Doe is a previously stored name entry in the UConnect™ phonebook. Refer to "Add Names to Your UConnect™ Phonebook," to learn how to store a name in the phonebook.
- The UConnect™ system will confirm the name and then dial the corresponding phone number, which may appear in the display of certain radios.

Add Names to Your UConnect™ Phonebook

NOTE: Adding names to phonebook is recommended when vehicle is not in motion.

- Press the "Phone" button to begin.
- After the "Ready" prompt and the following beep, say "Phonebook New Entry."
- When prompted, say the name of the new entry. Use of long names helps the voice recognition and is recommended. For example, say "Robert Smith" or "Robert" instead of "Bob."
- When prompted, enter the number designation (e.g., "Home," "Work," "Mobile," or "Pager"). This will allow you to store multiple numbers for each phonebook entry, if desired.
- When prompted, recite the phone number for the phonebook entry that you are adding.

After you are finished adding an entry into the phonebook, you will be given the opportunity to add more phone numbers to the current entry or to return to the main menu.

The UConnect™ system will allow you to enter up to 32 names in the phonebook with each name having up to four associated phone numbers and designations. Each language has a separate 32-name phonebook accessible only in that language.

Edit Entries in the UConnect™ Phonebook

NOTE: Editing phonebook entries is recommended when vehicle is not in motion.

- Press the 'Phone' button to begin.
- After the "Ready" prompt and the following beep, say "Phonebook Edit."
- You will then be asked for the name of the phonebook entry that you wish to edit.
- Next, choose the number designation (home, work, mobile, or pager) that you wish to edit.
- When prompted, recite the new phone number for the phonebook entry that you are editing.

After you are finished editing an entry in the phonebook, you will be given the opportunities to edit another entry in the phonebook, call the number you just edited, or return to the main menu.

"Phonebook Edit" can be used to add another phone number to a name entry that already exists in the phonebook. For example, the entry John Doe may have a mobile and a home number, but you can add John Doe's work number later using the "Phonebook Edit" feature.

Delete Entries in the UConnect™ Phonebook

NOTE: Editing phonebook entries is recommended when vehicle is not in motion.

- Press the 'Phone' button to begin.
- After the "Ready" prompt and the following beep, say "Phonebook Delete."
- After you enter the Phonebook Delete menu, you will then be asked for the name of the entry that you wish to delete. You can either say the name of a phonebook entry that you wish to delete or you can say "List Names" to hear a list of the entries in the phonebook

from which you choose. To select one of the entries from the list, press the "Voice Recognition" button while the UConnect™ system is playing the desired entry and say "Delete."

- After you enter the name, the UConnect™ system will ask you which designation you wish to delete, home, work, mobile, or pager. Say the designation you wish to delete.
- Note that only the phonebook entry in the current language is deleted.

After confirmation, the phonebook entries will be deleted. Note that only the phonebook in the current language is deleted.

Delete All Entries in the UConnect™ Phonebook

- Press the 'Phone' button to begin.
- After the "Ready" prompt and the following beep, say "Phonebook Erase All."
- The UConnect™ system will ask you to verify that you wish to delete all the entries from the phonebook.

- After confirmation, the phonebook entries will be deleted.

List All Names in the UConnect™ Phonebook

- Press the 'Phone' button to begin.
- After the "Ready" prompt and the following beep, say "Phonebook List Names."
- The UConnect™ system will play the names of all the phonebook entries.
- To call one of the names in the list, press the "Voice Recognition" button during the playing of the desired name, and then say "Call." NOTE: the user can also exercise "Edit" or "Delete" operations at this point.
- The UConnect™ system will then prompt you as to number designation you wish to call.
- The selected number will be dialed.

Phone Call Features

The following features can be accessed through the UConnect™ system if the feature(s) are available on your cellular service plan. For example, if your cellular service plan provides three-way calling, this feature can be accessed through the UConnect™ system. Check with your cellular service provider for the features that you have.

Answer or Reject an Incoming Call - No Call Currently in Progress

When you receive a call on your cellular phone, the UConnect™ system will interrupt the vehicle audio system, if on, and will ask if you would like to answer the call. To reject the call, press and hold the 'Phone' button until you hear a single beep indicating that the incoming call was rejected.

Answer or Reject an Incoming Call - Call Currently in Progress

If a call is currently in progress and you have another incoming call, you will hear the same network tones for call waiting that you normally hear when using your cell phone. Press the 'Phone' button to place the current call

on hold and answer the incoming call. NOTE: The UConnect™ system compatible phones in market today do not support rejecting an incoming call when another call is in progress. Therefore, the user can only either answer an incoming call or ignore it.

Making a Second Call while Current Call in Progress

To make a second call while you are currently in a call, press the 'Voice Recognition' button and say "Dial" or "Call" followed by the phone number or phonebook entry you wish to call. The first call will be on hold while the second call is in progress. To go back to the first call, refer to "Toggling Between Calls." To combine two calls, refer to "Conference Call."

Place/Retrieve a Call from Hold

To put a call on hold, press the 'Phone' button until you hear a single beep. This indicates that the call is on hold. To bring the call back from hold, press and hold the 'Phone' button until you hear a single beep.

Toggling Between Calls

If two calls are in progress (one active and one on hold), press the 'Phone' button until you hear a single beep indicating that the active and hold status of the two calls have switched. Only one call can be placed on hold at one time.

Conference Call

When two calls are in progress (one active and one on hold), press and hold the 'Phone' button until you hear a double beep indicating that the two calls have been joined into one conference call.

Three-Way Calling

To initiate three-way calling, press the 'Voice Recognition' button while a call is in progress and make a second phone call as described under "Making a Second Call while Current Call in Progress." After the second call has established, press and hold the 'Phone' button until you hear a double beep indicating that the two calls have been joined into one conference call.

Call Termination

To end a call in progress, momentarily press the 'Phone' button. Only the active call(s) will be terminated and if there is a call on hold, it will become the new active call.

Redial

- Press the 'Phone' button to begin.
- After the "Ready" prompt and the following beep, say "Redial."
- The UConnect™ system will call the last number that was dialed on your cellular phone. Note: this may not be the last number dialed from the UConnect™ system.

Call Continuation

Call continuation is progression of a phone call on UConnect™ system after the vehicle ignition key has been switched to off. Call continuation functionality available on the vehicle can be any one of three types:

- After ignition key is switched off, a call can continue on the UConnect™ system either until the call ends or

until the vehicle battery condition dictates cessation of the call on the UConnect™ system and transfer of the call to the mobile phone.

- After ignition key is switched to off, a call can continue on the UConnect™ system for certain duration, after which the call is automatically transferred from the UConnect™ system to the mobile phone.
- An active call is automatically transferred to the mobile phone after ignition key is switched to off.

UConnect™ System Features

Language Selection

To change the language that the UConnect™ system is using,

- Press the 'Phone' button to begin.
- After the "Ready" prompt and the following beep, say the name of the language you wish to switch to (English, Espanol, or Francais, if so equipped).
- Continue to follow the system prompts to complete language selection.

After selecting one of the languages, all prompts and voice commands will be in that language.

NOTE: After every UConnect™ language change operation, only the language specific 32-name phonebook is usable. The paired phone name is not language specific and usable across all languages.

Emergency Assistance

If you are in an emergency and the mobile phone is reachable:

- Pick up the phone and manually dial the emergency number for your area.

If the phone is not reachable and the UConnect™ system is operational, you may reach the emergency number as follows:

- Press the 'Phone' button to begin.
- After the "Ready" prompt and the following beep, say "Emergency" and the UConnect™ system will instruct the paired cellular phone to call the emergency number. This feature is only supported in the USA.

NOTE: The emergency number dialed is based on the Country where the vehicle is purchased (911 for USA and Canada and 060 for Mexico). The number dialed may not be applicable with the available cellular service and area.

The UConnect™ system does slightly lower your chances of successfully making a phone call as to that for the cell phone directly.

Your phone must be turned on and paired to the UConnect™ system to allow use of this vehicle feature in emergency situations when the cell phone has network coverage and stays paired to the UConnect™ system.

Towing Assistance

If you need towing assistance,

- Press the 'Phone' button to begin.
- After the "Ready" prompt and the following beep, say "Towing Assistance."

NOTE: The Towing Assistance number dialed is based on the Country where the vehicle is purchased (1-800-528-2069 for USA, 1-877-213-4525 for Canada, 55-14-3454 for Mexico city and 1-800-712-3040 for outside Mexico city in Mexico).

Please refer to the 24-Hour "Towing Assistance" coverage details in the Warranty information booklet and on the 24-Hour Towing Assistance Card.

Paging

To learn how to page, refer to "Working with Automated Systems." Paging works properly except for pagers of certain companies which time-out a little too soon to work properly with the UConnect™ system.

Voice Mail Calling

To learn how to access your voice mail, refer to "Working with Automated Systems."

Working with Automated Systems

This method is designed to be used in instances where one generally has to press numbers on the cellular phone keypad while navigating through an automated telephone system.

You can use your UConnect™ system to access a voice-mail system or an automated service, such as, paging service or automated customer service. Some services require immediate response selection, in some instances, that may be too quick for use of UConnect™ system.

When calling a number with your UConnect™ system that normally requires you to enter in a touch-tone sequence on your cellular phone keypad, you can push the 'Voice Recognition' button and say the sequence you wish to enter followed by the word "Send." For example, if required to enter your pin number followed with a pound 3 7 4 6 #, you can press the 'Voice Recognition' button and say "3 7 4 6 # Send." Saying a number, or sequence of numbers, followed by "Send" is also to be used to navigate through an automated customer service center menu structure and to leave a number on a pager.

Barge In - Overriding Prompts

The 'Voice Recognition' button can be used when you wish to skip part of a prompt and issue your voice recognition command immediately. For example, if a prompt is playing "Would you like to pair a phone, clear

a...," you could press the 'Voice Recognition' button and say "Pair a Phone" to select that option without having to listen to the rest of the voice prompt.

Turning Confirmation Prompts On/Off

Turning confirmation prompts off will stop the system from confirming your choices (e.g., the UConnect™ system will not repeat a phone number before you dial it).

- Press the 'Phone' button to begin.
- After the "Ready" prompt and the following beep, say "Setup Confirmations." The UConnect™ system will play the current confirmation prompt status and you will be given the choice to change it.

Phone and Network Status Indicators

If available on the radio and/or on a premium display such as the instrument panel cluster, and supported by your cell phone, the UConnect™ system will provide notification to inform you of your phone and network status when you are attempting to make a phone call using UConnect™. The status is given for roaming network signal strength, phone battery strength, etc.

Dialing Using the Cellular Phone Keypad

You can dial a phone number with your cellular phone keypad and still use the UConnect™ system (while dialing via the cell phone keypad, the user must exercise caution and take precautionary safety measures). By dialing a number with your paired Bluetooth™ cellular phone, the audio will be played through your vehicle's audio system. The UConnect™ system will work the same as if you dial the number using voice recognition.

NOTE: Certain brands of mobile phones do not send the dial ring to the UConnect™ system to play it on the vehicle audio system, so you will not hear it. Under this situation, after successfully dialing a number, the user may feel that the call did not go through even though the call is in progress. Once your call is answered, you will hear the audio.

Mute/Un-mute (Mute off)

When you mute the UConnect™ system, you will still be able to hear the conversation coming from the other party, but the other party will not be able to hear you. In order to mute the UConnect™ system:

- Press the 'Voice Recognition' button.

- After the "Ready" prompt and the following beep, say "Mute."

In order to un-mute the UConnect™ system:

- Press the 'Voice Recognition' button.
- After the "Ready" prompt and the following beep, say "Mute-off."

Information Service

When using AT&T Wireless Service, dialing to phone number "#121," you can access voice activated automated system to receive news, weather, stocks, traffic, etc. related information.

Advanced Phone Connectivity**Transfer Call to and from Cellular Phone**

The UConnect™ system allows on going calls to be transferred from your cellular phone to the UConnect™ system without terminating the call. To transfer an ongoing call from your UConnect™ paired cellular phone to the UConnect™ system or vice-versa, press the 'Voice Recognition' button and say "Transfer Call."

Connect or Disconnect Link Between the UConnect™ System and Cellular Phone

Your cellular phone can be paired with many different electronic devices, but can only be actively "connected" with one electronic device at a time.

If you would like to connect or disconnect the Bluetooth™ connection between a UConnect™ paired cellular phone and the UConnect™ system, then follow the instruction described in your cellular phone user's manual.

List Paired Cellular Phone Names

- Press the 'Phone' button to begin.
- After the "Ready" prompt and the following beep, say "Setup Phone pairing".
- When prompted, say "List Phones."
- The UConnect™ system will play the phone names of all paired cellular phones in order from the highest to the lowest priority. To "select" or "delete" a paired phone being announced, press the 'Voice recognition'

button and say "Select" or "Delete." Also, see the next two sections for an alternate way to "select" or "delete" a paired phone.

Select another Cellular Phone

This feature allows you to select and start using another phone with the UConnect™ system. The phone must have been previously paired to the UConnect™ system that you want to use it with.

- Press the 'Phone' button to begin.
- After the "Ready" prompt and the following beep, say "Setup Select Phone" and follow the prompts.
- You can also press the 'Voice Recognition' button anytime while the list is being played, and then choose the phone that you wish to select.
- The selected phone will be used for the next phone call. If the selected phone is not available, the UConnect™ system will return to using the highest priority phone present in or near (approximately within 30 feet) the vehicle.

Delete UConnect™ Paired Cellular Phones

- Press the 'Phone' button to begin.
- After the "Ready" prompt and the following beep, say "Setup Phone Pairing."
- At the next prompt, say "Delete" and follow the prompts.
- You can also press the 'Voice Recognition' button anytime while the list is being played and then choose the phone you wish to delete.

Things You Should Know About Your UConnect™ System**Voice Recognition (VR)**

- Always wait for the beep before speaking.
- Speak normally, without pausing, just as you would speak to a person sitting approximately eight (8) feet away from you.
- Make sure that no one other than you is speaking during a voice recognition period.
- Performance is maximized under:
 - low-to-medium blower setting,
 - low-to-medium vehicle speed,
 - low road noise,
 - smooth road surface,
 - fully closed windows,
 - dry weather condition.
- Even though the system is designed for users speaking in North American English, French, and Spanish accents, the system may not always work for some.
- When navigating through an automated system, such as voice mail, or when sending a page at the end of speaking the digit string, make sure to say "send."
- Storing names in phonebook when vehicle is not in motion is recommended.
- It is not recommended to store similar sounding names in the UConnect™ phonebook.

- UConnect™ phonebook nametag recognition rate is optimized for the voice of the person who stored the name in the phonebook.
- You can say "O" (letter "O") for "0" (zero). "800" must be spoken "eight-zero-zero."
- Even though international dialing for most number combinations is supported, some shortcut dialing number combinations may not be supported.

Far End Audio Performance

- Audio quality is maximized under:
 - low-to-medium blower setting,
 - low-to-medium vehicle speed,
 - low road noise,
 - smooth road surface,
 - fully closed windows, and
 - dry weather condition.

- Operation from driver seat.

- Performance, such as audio clarity, echo, and loudness to a large degree rely on the phone and network, and not the UConnect™ system.
- Echo at far end can sometime be reduced by lowering the in-vehicle audio volume.

3

Bluetooth Communication Link

Occasionally, Cellular phones have been found to lose connection to the UConnect™ system. When this happens, the connection can generally be re-established by switching the phone off/on. Your cell phone is recommended to remain in Bluetooth "on" mode.

Power-Up

After switching the ignition key from OFF to either ON or ACC position, or after a reset, you must wait at least five (5) seconds prior to using the system.

Voice Command Tree

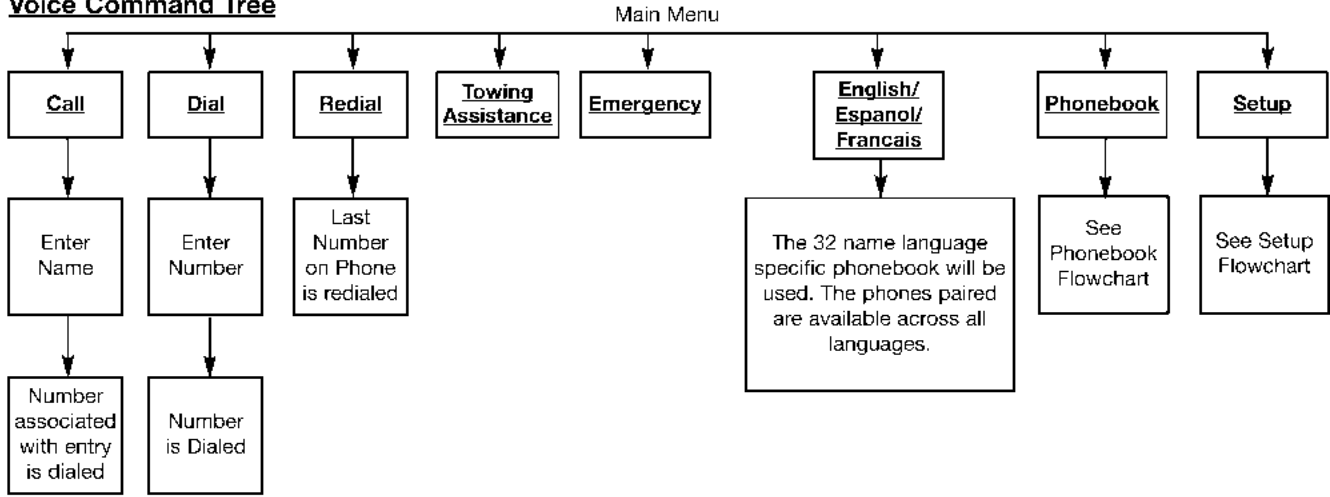

Note: Available Voice commands are shown in bold face and are underlined.

Voice Tree - Phonebook

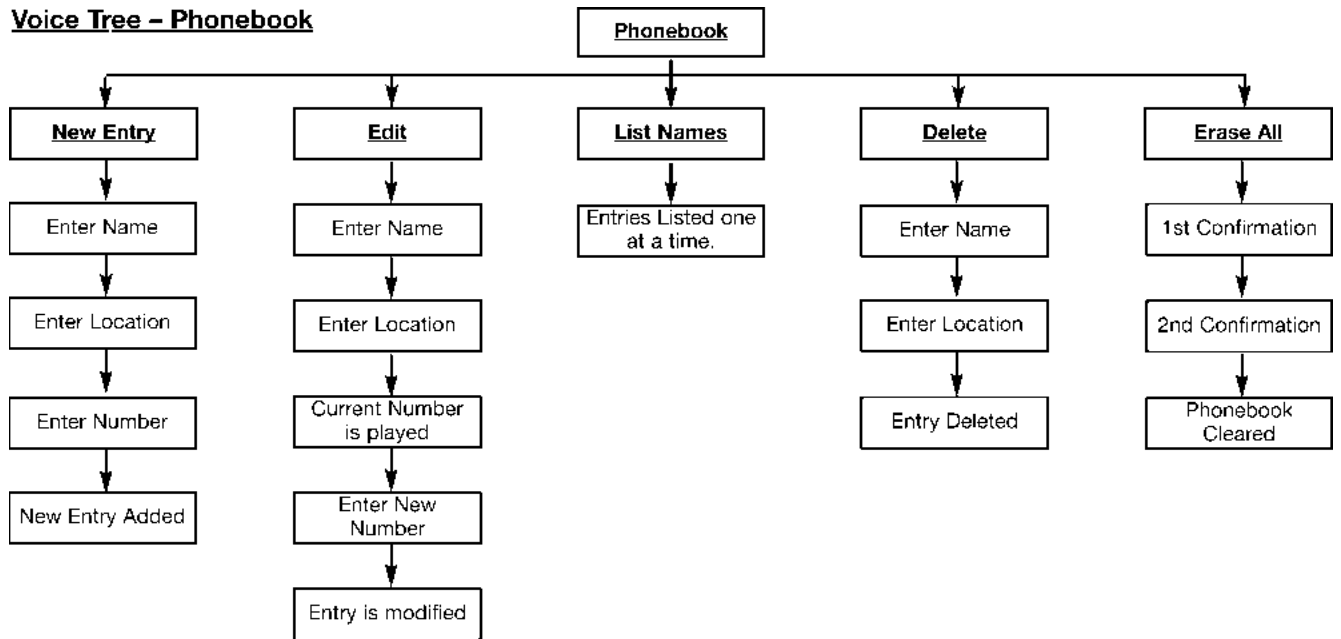

Note: Available Voice commands are shown in bold face and are underlined.

Voice Tree - Setup

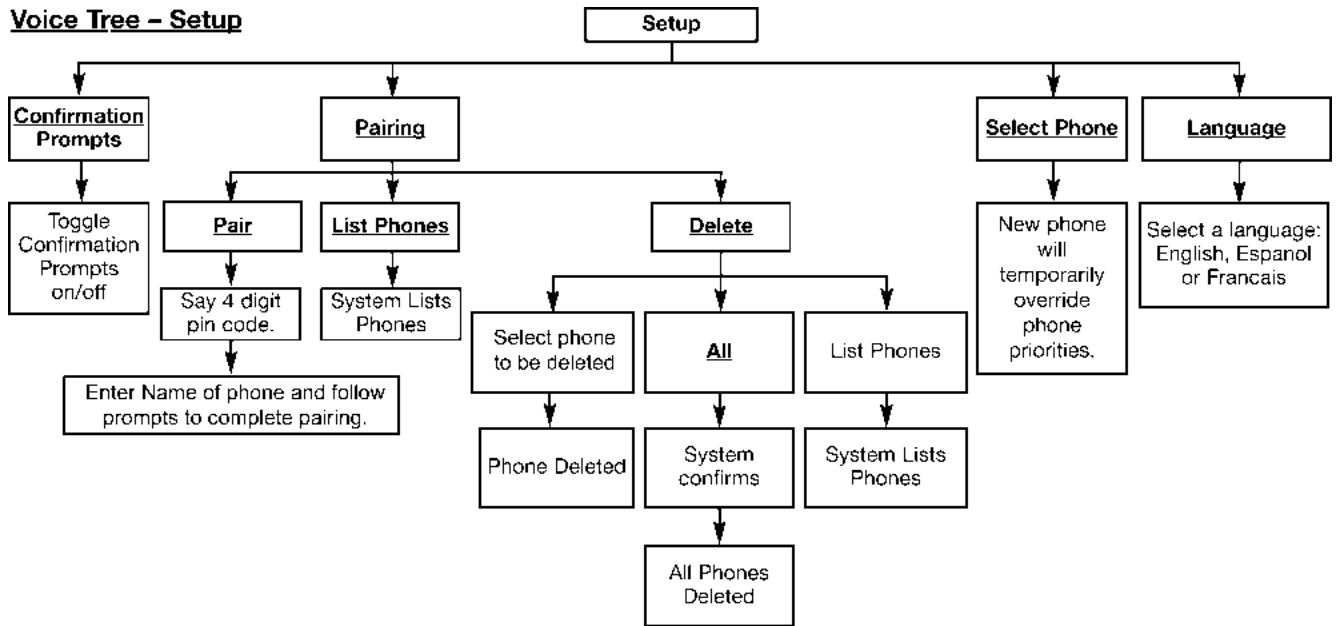

Note: Available Voice commands are shown in bold face and are underlined.

| | North American English |
|----------------------|-----------------------------|
| Primary | Alternate(s) |
| Zero | Oh |
| Add location | Add new |
| All | All of them |
| Confirmation prompts | Confirmations prompts |
| Delete a name | Delete |
| Language | Select language |
| List names | List all |
| List paired phones | List phones |
| Pager | Beeper |
| Phone pairing | Pairing |
| Phonebook | Phone book |
| Return to main menu | Return. Main menu |
| Select phone | select |
| Set up | Phone settings phone set up |

SEATS

Power Seats

The power seat switch is on the outboard side of the seat near the floor. Use this switch to move the driver's seat up or down, forward or rearward, or to tilt the seat. The passenger's seat will move up or down, forward or rearward.

3

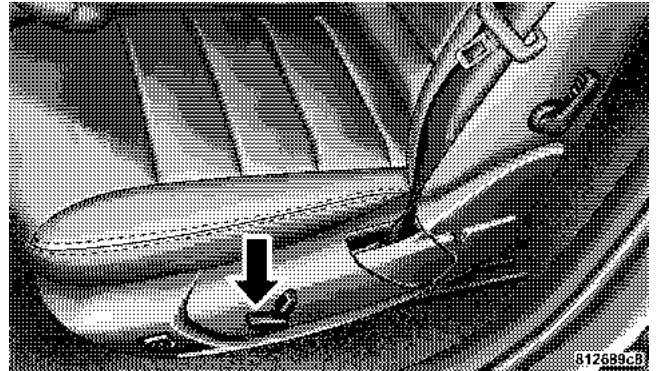

Power Seat Switch

WARNING!

Adjusting a seat while the vehicle is moving is dangerous. The sudden movement of the seat could cause you to lose control. The seat belt might not be properly adjusted and you could be injured. Adjust the seat only while the vehicle is parked.

CAUTION!

Do not place any article under a power seat as it may cause damage to the seat controls.

Power Reclining Seats

The recliner control is located on the outboard side of the seat.

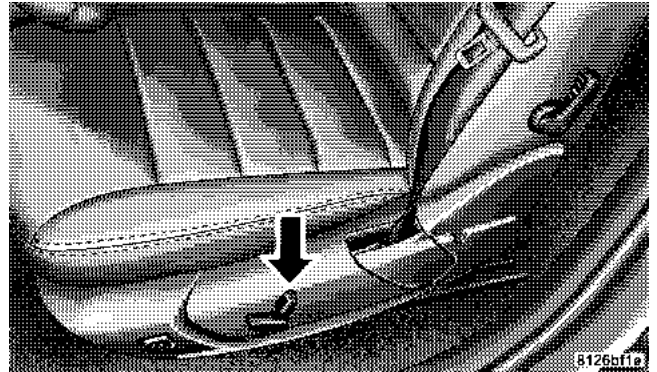

Power Seat Recline Switch

WARNING!

Do not ride with the seatback reclined so that the shoulder belt is no longer resting against your chest. In a collision you could slide under the seat belt and be seriously or even fatally injured. Use the recliner only when the vehicle is parked.

Lumbar Support

This feature allows you to increase or decrease the amount of lumbar support. Turn the control lever forward to increase and rearward to decrease the desired amount of lumbar support.

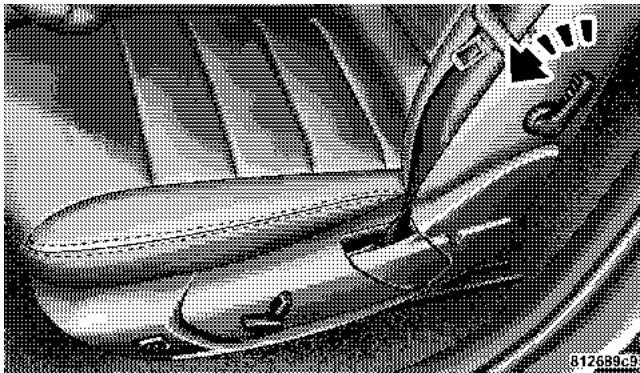

Lumbar Support Control Lever

Head Restraints

Head restraints can reduce the risk of whiplash injury in the event of impact from the rear. Adjustable restraints should be adjusted so that the upper edge is as high as practical.

The head restraints have a locking button, which must be pushed in to lower the head restraint. The restraints may be raised without pushing in the button.

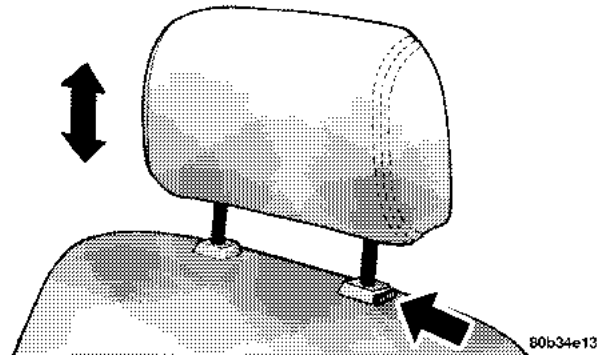

Adjustable Head Restraint

Heated Seats

Heated seats provide comfort and warmth on cold days and can help soothe sore muscles and backs. The heaters provide the same heat level for both cushion and back. The driver seat and front passenger seat are heated.

The controls for each heater are located near the bottom center of the instrument panel. After turning on the

ignition, you can choose from High, Off, or Low heat settings. Amber LEDs in the top portion of each switch indicate the level of heat in use. Two LEDs will illuminate for high, one for low, and none for off.

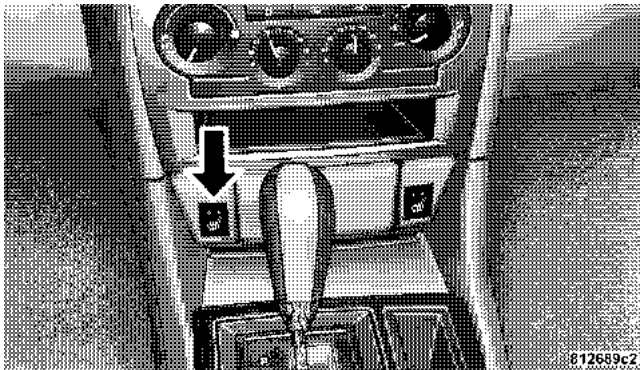

Front Heated Seat Switch

Press the switch once to select high-level heating. Press the switch a second time to select low-level heating. Press the switch a third time to shut off the heating elements.

If high-level heating is selected, the system will automatically switch to the low level after 30 minutes of continuous operation. At that time, the number of illuminated

LEDs changes from two to one, indicating the change. Operation on the low setting also turns off automatically after 30 minutes.

NOTE: Once a heat setting is selected, heat will be felt within two to five minutes.

WARNING!

Persons who are unable to feel pain to the skin because of advanced age, chronic illness, diabetes, spinal cord injury, medication, alcohol use, exhaustion or other physical condition must exercise care when using the seat heater. It may cause burns even at low temperatures, especially if used for long periods.

Do not place anything on the seat that insulates against heat, such as a blanket or cushion. This may cause the seat heater to overheat.

Folding Rear Seat

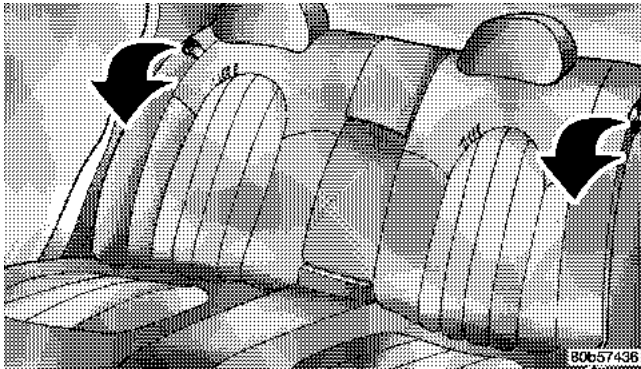

Folding Rear Seats

The rear seatbacks can be folded forward to provide an additional storage area. Pull on the loops shown in the illustration to fold down either or both seatbacks. These loops can be tucked away when not in use.

When the seatback is folded to the upright position, make sure it is latched by strongly pulling on the top of the seatback above the seat strap.

WARNING!

- Be certain that the seatback is securely locked into position. If the seatback is not securely locked into position the seat will not provide the proper stability for child seats and/or passengers. An improperly latched seat could cause serious injury.
- The cargo area in the rear of the vehicle (with the rear seatbacks in the locked-up or folded down position) should not be used as a play area by children when the vehicle is in motion. They could be seriously injured in an accident. Children should be seated and using the proper restraint system.

DRIVER MEMORY SEAT — IF EQUIPPED

This feature allows the driver to store up to two different memory profiles, for easy recall through a memory switch. Each memory profile contains desired position settings for the driver seat, side mirror, adjustable pedals, and power tilt and telescopic steering column, and a set of desired radio station presets.

The memory switch is located on the driver's door panel. The switch contains an (S) button to activate the memory save function. It also contains a rocker switch labeled with the number (1) and the number (2). The rocker switch allows the driver to recall either of two pre-programmed memory profiles by pressing the appropriate side of the switch.

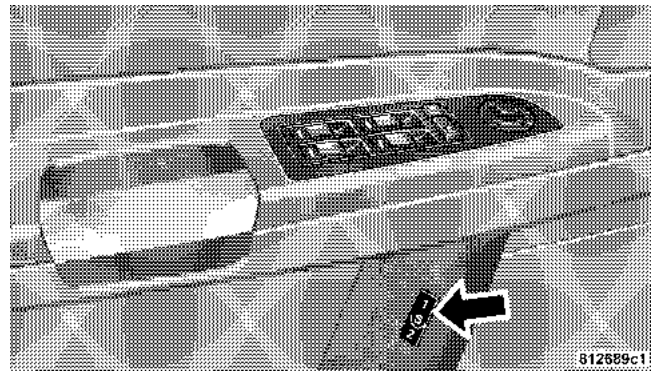

Memory Switch

Programming The Memory Feature

To create a new memory profile, perform the following:

NOTE: Saving a new memory profile will erase an existing profile from memory.

1. Adjust all memory profile settings to desired preferences (i.e. seat, side mirror, adjustable pedals, power tilt and telescopic steering column, and radio station presets).

2. Press and release the Set (S) button on the memory switch, then press the side of the rocker switch labeled (1) within 5 seconds. The Electronic Vehicle Information Center (EVIC) will display which memory position is being set.

If desired, a second memory profile can be stored into memory as follows:

1. Adjust all memory profile settings to desired preferences (i.e. seat, side mirror, adjustable pedals, power tilt and telescopic steering column, and radio station presets).

2. Press and release the Set (S) button on the memory switch, then press the side of the rocker switch labeled (2) within 5 seconds. The Electronic Vehicle Information Center (EVIC) will display which memory position is being set.

NOTE: Memory profiles can be set without the vehicle in Park, but the vehicle must be in Park to recall a memory profile.

NOTE: The Recall Memory with Remote Key Unlock feature can be enabled or disabled. For details, refer to

“Recall Memory with Remote Key Unlock,” under “Personal Settings (Customer Programmable Features),” under “Electronic Vehicle Information Center (EVIC)” in Section 4 of this manual.

Linking & Unlinking the Remote Keyless Transmitter to the Memory Feature

Your Remote Keyless Entry Transmitters can be programmed to recall one of two pre-programmed memory profiles by pressing the UNLOCK button on the Remote Keyless Entry Transmitter.

To program your transmitters, perform the following:

1. Remove key from ignition.
2. Select desired memory profile 1 or 2.
3. Press and release the Set (S) button on the memory switch, then press and release the side of the rocker switch labeled 1 or 2 accordingly. “Memory Profile Set” (1 or 2) will display in the Electronic Vehicle Information Center (EVIC).
4. Press and release the LOCK button on the transmitter within 10 seconds.

NOTE: Your transmitters can be unlinked to your memory settings by pressing the Set (S) button followed by the UNLOCK button on the transmitter in Step 4 above.

Memory Position Recall

NOTE: The vehicle must be in Park to recall memory positions. If a recall is attempted when the vehicle is not in Park, a message will display in the Electronic Vehicle Information Center (EVIC).

To recall the memory settings for driver one, press memory button number 1 on the driver's door or the "Unlock" button on the Remote Keyless Entry transmitter linked to memory position 1.

To recall the memory setting for driver two, press memory button number 2 on the driver's door or the "Unlock" button on the Remote Keyless Entry transmitter linked to memory position 2.

A recall can be cancelled by pressing any of the memory buttons (S, 1, or 2) on the drivers door during a recall. When a recall is cancelled, the driver seat, side mirror,

adjustable pedals, and power tilt and telescopic steering column stop moving. A delay of one second will occur before another recall can be selected.

Easy Entry/Exit Seat (Available with Memory Seat Only)

This feature provides automatic driver seat positioning to enhance driver mobility when entering and exiting the vehicle.

The distance the driver seat moves depends on where you have the driver seat positioned when you remove the key from the ignition switch.

- When you remove the key from the ignition switch, the driver seat will move about 2.4 inches (60 mm) rearward if the driver seat position is greater than or equal to 3.5 inches (90 mm) forward of the rear stop. The seat will return to its previously set position when you insert the key into the ignition switch and turn it out of the LOCK position.
- When you remove the key from the ignition switch, the driver seat will move to a position 1.2 inches (30 mm) forward of the rear stop if the driver seat position

is between 2.4 inches and 3.5 inches (60 mm and 90 mm) forward of the rear stop. The seat will return to its previously set position when you insert the key into the ignition switch and turn it out of the LOCK position.

- The Easy Entry/Easy Exit feature is disabled when the driver seat position is less than 2.4 inches (60 mm) forward of the rear stop. At this position, there is no benefit to the driver by moving the seat for Easy Exit or Easy Entry.

Each stored memory setting will have an associated Easy Entry and Easy Exit position.

NOTE: The Easy Entry/Easy Exit feature can be enabled or disabled. For details, refer to “Automatically Move Seat Back on Exit,” under “Personal Settings (Customer Programmable Features),” under “Electronic Vehicle Information Center (EVIC)” in Section 4 of this manual.

TO OPEN AND CLOSE THE HOOD

Two latches must be released to open the hood. First, pull the hood release lever located under the left side of the instrument panel.

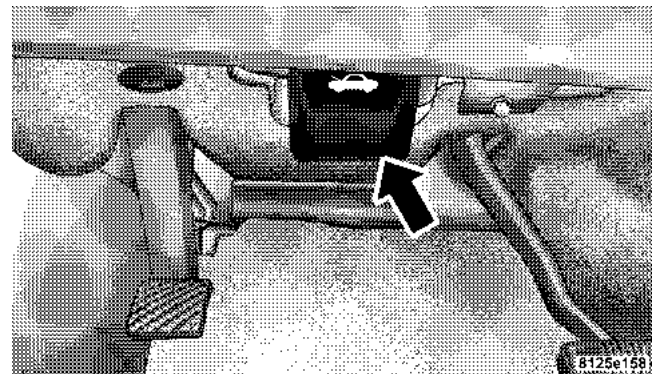

Hood Release Lever

Next, move to the outside of the vehicle and push the safety catch to the left. The safety catch is located under the center front edge of the hood.

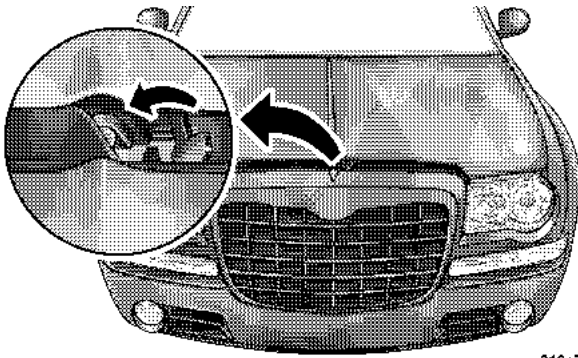

818c748d

Hood Safety Catch

Use the hood prop rod (if equipped) to secure the hood in the open position.

To prevent possible damage, do not slam the hood to close it. Lower the hood, until it is open approximately 6 inches (15 cm), and then drop it. This should secure both latches. Never drive your vehicle unless the hood is fully closed, with both latches engaged.

WARNING!

If the hood is not fully latched, it could fly up when the vehicle is moving and block your forward vision. You could have a collision. Be sure all hood latches are fully latched before driving.

LIGHTS**Headlight Switch**

 The headlight switch is located on the left side of the instrument panel. This switch controls the operation of the headlights, parking lights, instrument panel lights, instrument panel light dimming, interior lights, and fog lights.

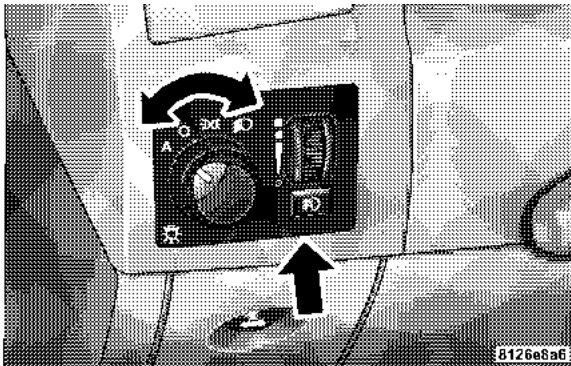

Headlight Switch

Rotate the headlight switch clockwise to the first detent for parking light and instrument panel light operation. Turn it to the second detent for headlight, parking light, and instrument panel light operation.

Automatic Headlights

This system automatically turns the headlights ON or OFF according to ambient light levels. To turn the system ON, rotate the headlight switch counter-clockwise to the AUTO (A) position. When the system is ON, the Headlight Time Delay feature is also ON. This means the headlights will stay ON for up to 90 seconds after you turn the ignition switch OFF. To turn the Automatic System OFF, move the headlight switch out of the AUTO (A) position.

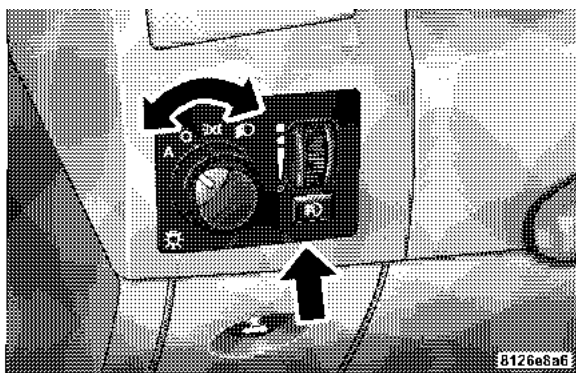

Headlight Switch

NOTE: The engine must be running before the headlights will come ON in the Automatic mode.

Headlights On with Wipers

When this feature is active, the headlights will turn on approximately 10 seconds after the wipers are turned on if the headlight switch is placed in the AUTO position. In addition, the headlights will turn off when the wipers are turned off if they were turned on by this feature.

The Headlights On with Wipers feature can be enabled or disabled. For details, refer to "Headlights On with Wipers," under "Personal Settings (Customer Programmable Features)," under "Electronic Vehicle Information Center" in Section 4 of this manual.

SmartBeams — If Equipped

The SmartBeam system provides increased forward lighting at night by automating high beam control through the use of a digital camera mounted on the inside rearview mirror. This camera detects vehicle specific light and automatically switches from high beams to low beams until the approaching vehicle is out of view.

To Activate:

1. Select "Automatic High Beams — ON" through the Electronic Vehicle Information Center (EVIC). For details, refer to "Automatic High Beams," under "Personal Settings (Customer Programmable Features)," under "Electronic Vehicle Information Center" in Section 4 of this manual.
2. Rotate the headlight switch counter-clockwise to the AUTO (A) position.

3. Push the Multi-Function Lever away from you to switch the headlights to the HIGH BEAM position.

NOTE: This system will not activate until the vehicle is at or above 25 mph (40 km/h).

To Deactivate:

Perform either of the following steps to deactivate the SmartBeam system.

1. Pull the Multi-Function Lever toward you to switch the headlights from the HIGH BEAM to the LOW BEAM position.

2. Rotate the headlight switch clockwise from the AUTO (A) to the ON position.

NOTE: Broken, muddy, or obstructed headlights and taillights of vehicles in the field of view will cause headlights to remain on longer (closer to the vehicle). Also, dirt, film, and other obstructions on the windshield or camera lens will cause the system to function improperly.

Headlight Time Delay

This feature provides the safety of headlight illumination for 90 seconds (programmable) when leaving your vehicle in an unlighted area.

To activate the delay feature, turn off the ignition switch while the headlights are still on. Then, turn off the headlights within 45 seconds. The delay interval begins when headlight switch is turned off.

If you turn the headlights, park lights, or ignition switch on again, the system will cancel the delay.

If you turn the headlights off before the ignition, they will turn off in the normal manner.

NOTE: The lights must be turned off within 45 seconds of turning the ignition off to activate this feature

The Headlight delay time is programmable. For details, refer to "Delay Turning Headlights Off," under "Personal Settings (Customer Programmable Features)," under "Electronic Vehicle Information Center (EVIC)" in Section 4 of this manual.

Daytime Running Lights (Canada Only)

The high beam headlights will come on as Daytime Running Lights, whenever the ignition switch is on, the headlights are off, and the parking brake is off. The headlight switch must be used for normal nighttime driving.

Lights-on Reminder

If the headlights or parking lights are on after the ignition is turned OFF, a chime will sound to alert the driver when the driver's door is opened.

Fog Lights

 The front fog light switch is on the headlight switch below the dimmer control. To activate the front fog lights, turn on the parking lights or the low beam headlights and press the fog light switch.

An indicator light in the instrument cluster illuminates when the fog lights are turned on.

NOTE: The fog lights will operate with the low beam headlights or parking lights on. However, selecting the high beam headlights will turn off the fog lights.

Multi-Function Lever

The multi-function lever controls the operation of the turn signals, headlight beam selection, and passing lights. The lever is located on the left side of the steering column.

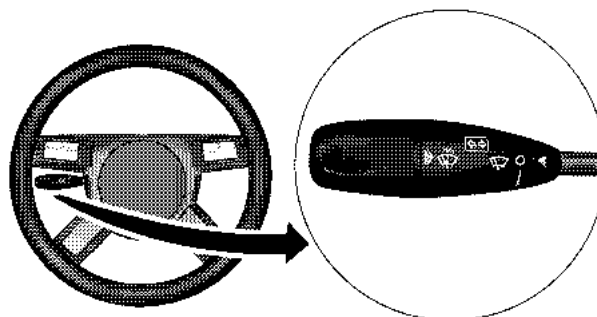

818c9c32

Multi-Function Lever**Turn Signals**

Move the Multi-Function Lever up or down and the corresponding turn signal indicator in the instrument cluster flashes to show proper operation of the front and rear turn signal lights. You can also signal a lane change

by moving the lever partially up or down without moving beyond the detent. Releasing the lever at the detent will provide 3 flashes.

If either light has a very fast flash rate, check for a defective outside light bulb. If an indicator fails to light when the lever is moved, it would suggest that the fuse or indicator is defective or there may be a circuit failure.

NOTE: A "Turn Signal On" message will appear in the Electronic Vehicle Information Center (EVIC) and a continuous chime will sound if the vehicle is driven more than 1 mile (1.6 km) with either turn signal on.

Highbeam/Lowbeam Select Switch

Push the Multi-Function Lever away from you to switch the headlights to HIGH beam. Pull the Lever towards you to switch the headlights back to LOW beam.

Flash to Pass

You can signal another vehicle with your headlights by lightly pulling the Multi-Function Lever toward you. This will cause the headlights to turn on at high beam and remain on until the lever is released.

Overhead Console Map/Reading Lights

These lights are mounted between the sun visors on the overhead console. Each light is turned ON by pressing the lens. Press the lens a second time to turn OFF the light. These lights also turn on when a door is opened, or when the unlock button on the remote keyless entry transmitter is pressed, or when the dimmer control is turned fully upward, past the second detent.

3

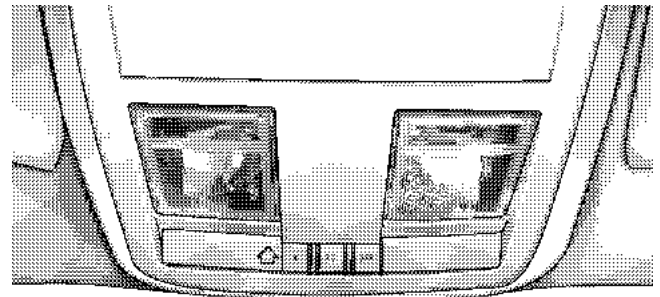

8125e174

Overhead Console

Interior Lights

The interior lights come on when a door is opened.

To protect the battery, the interior lights will turn off automatically 10 minutes after the ignition switch is moved to the LOCK position. This will occur if the interior lights were switched on manually or are on because a door is open. This includes the glove box light, but not the trunk light. To restore interior light operation, either turn the ignition switch ON or cycle the light switch.

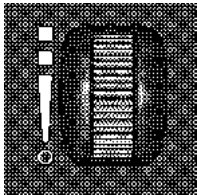
Dimmer Control

The dimmer control is part of the headlight switch, and is located on the left side of the instrument panel. With the parking lights or headlights on, rotating the dimmer control upward will increase the brightness of the instrument panel lights.

Dome Light Position

Rotate the dimmer control completely upward to the second detent to turn on the interior lights. The interior lights will remain on when the dimmer control is in this position.

Interior light Defeat (OFF)

Rotate the dimmer control to the extreme bottom "OFF" position. The interior lights will remain off when the doors are open.

Parade Mode (Daytime Brightness Feature)

Rotate the dimmer control upward to the first detent. This feature brightens all text displays such as the odometer, Electronic Vehicle Information Center (EVIC), and radio when the parking lights or headlights are on.

WINDSHIELD WIPERS AND WASHERS

The multi-function lever operates the windshield wipers and washer when the ignition switch is in the ON position. The lever is located on the left side of the steering column.

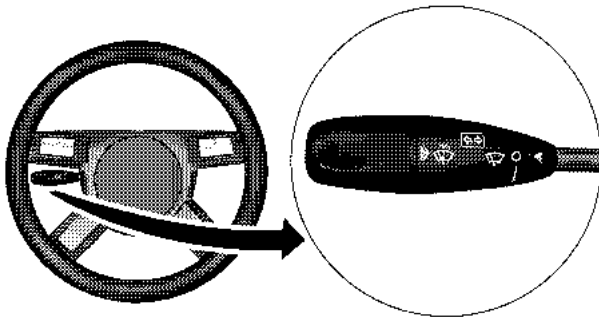

818c9c32

Windshield Wiper/Washer Control

Rotate the end of the multi-function lever to the first detent past the intermittent settings for Low-speed wiper operation, or to the second detent past the intermittent settings for High-speed wiper operation.

CAUTION!

Turn the windshield wipers off when driving through an automatic car wash. Damage to the windshield wipers may result if the wiper switch is left in any position other than OFF.

3

Intermittent Wiper System

Use the intermittent wiper when weather conditions make a single wiping cycle with a variable pause between cycles desirable. Rotate the end of the multi-function lever to the first detent position, and then turn the end of the lever to select the desired delay interval. There are six delay settings, which allow you to regulate the wipe interval from a minimum of one cycle every second to a maximum of approximately 23 seconds between cycles.

WARNING!

Sudden loss of visibility through the windshield could lead to an accident. You might not see other vehicles or other obstacles. To avoid sudden icing of the windshield during freezing weather, warm the windshield with defroster before and during windshield washer use.

Mist Feature

Push the multi-function lever inward (toward the steering column) to the first detent to activate a single wipe cycle to clear off road mist or spray from a passing vehicle. The wipers will continue to operate until you release the lever.

Windshield Washers

To use the washer, push the multi-function lever inward (toward the steering column) to the second detent and hold it for as long as washer spray is desired.

If you activate the washer while the windshield wiper control is in the delay range, the wipers will operate for

two wipe cycles after releasing the lever and then resume the intermittent interval previously selected.

If you activate the washer while the windshield wiper is turned OFF, the wipers will operate for two wipe cycles and then turn OFF.

Headlights On with Wipers

When this feature is active, the headlights will turn on approximately 10 seconds after the wipers are turned on if the headlight switch is placed in the AUTO position. In addition, the headlights will turn off when the wipers are turned off if they were turned on by this feature.

The Headlights On With Wipers feature can be enabled or disabled. For details, refer to "Headlights On with Wipers," under "Personal Settings (Customer Programmable Features)," under "Electronic Vehicle Information Center" in Section 4 of this manual.

Rain Sensing Wipers

This feature senses moisture on the windshield and automatically activates the wipers for the driver. This feature is especially useful for road splash or over spray from the windshield washers of the vehicle ahead. Rotate

the end of the multi-function lever to one of the six intermittent wiper settings to activate this feature.

The sensitivity of the system is adjustable from the multi-function lever. Wiper delay position 1 is the least sensitive and wiper delay position 6 is the most sensitive. Choose setting 3 or 4 for normal rain conditions. Choose setting 2 or 1 if you desire less wiper sensitivity. Choose setting 5 or 6 if you desire more sensitivity. Place the lever in the OFF position when not using the system.

NOTE:

- The rain-sensing feature will not operate when the wiper speed is in the LOW or HIGH position.
- The rain-sensing feature may not function properly when ice or dried salt water is present on the windshield.
- Use of Rain-X® or products containing wax or silicone may reduce rain sensor performance.
- The Rain Sense feature can be enabled or disabled. For details, refer to “Rain Sensing Intermittent Wipers,” under “Personal Settings (Customer Programmable

Features),” under “Electronic Vehicle Information Center (EVIC)” in Section 4 of this manual.

The rain sensing system has protective features for the wiper blades and arms. It will not operate under the following conditions:

- **Low Temperature Wipe Inhibit** — The rain-sensing feature will not operate when the ignition is first switched ON, and the vehicle is stationary, and the outside temperature is below 32° F (0° C), unless the wiper control on the multi-function lever is moved, or the vehicle speed becomes greater than 0 mph (0 km/h), or the outside temperature rises above freezing.
- **Neutral Wipe Inhibit** — The rain-sensing feature will not operate when the ignition is ON, and the transmission shift lever is in the N (Neutral) position, and the vehicle speed is less than 5 mph (8 km/h), unless the wiper control on the multi-function lever is moved or the shift lever is moved out of the N (Neutral) position.

Adding Washer Fluid

The windshield washer fluid reservoir is located in the front of the engine compartment on the passenger side of the vehicle. Be sure to check the fluid level in the reservoir at regular intervals. Fill the reservoir with windshield washer solvent (not radiator antifreeze) and operate the system for a few seconds to flush out the residual water.

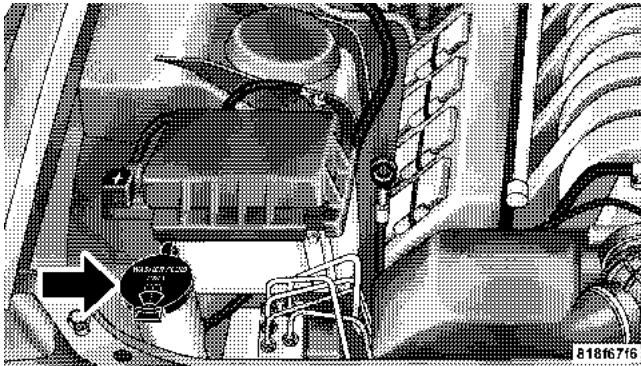

Washer Fluid Reservoir

The fluid reservoir will hold nearly 1 gallon (4 liters) of washer fluid when the message “Low Washer Fluid” appears in the Electronic Vehicle Information Center (EVIC).

WARNING!

Commercially available windshield washer solvents are flammable. They could ignite and burn you. Care must be exercised when filling or working around the washer solution.

HEADLIGHT WASHERS

The multi-function lever operates the headlight washers when the ignition switch is in the ON position and the headlights are ON. The multi-function lever is located on the left side of the steering column.

To use the headlight washers, push the multi-function lever inward (toward the steering column) to the second detent and release it. The headlight washers will spray a timed high-pressure spray of washer fluid onto each headlight lens. In addition, the windshield washers will spray the windshield and the windshield wipers will cycle.

NOTE: The headlight washers will operate on the first spray of the windshield washer and then every fourth spray after that.

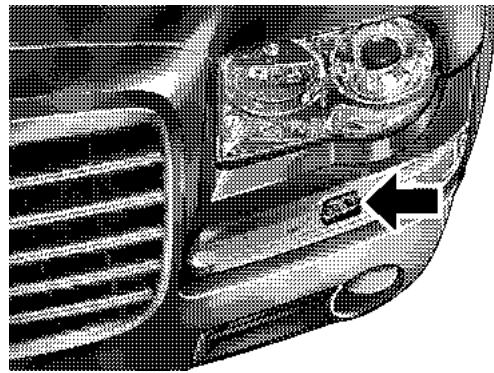

Headlight Washer

818c9c1b

Adding Washer Fluid

The headlight washer and windshield washer share the same fluid reservoir. The reservoir is located in the front of the engine compartment on the passenger side of the vehicle. Be sure to check the fluid level in the reservoir at regular intervals. Fill the reservoir with windshield washer solvent (not radiator antifreeze) and operate the system for a few seconds to flush out the residual water.

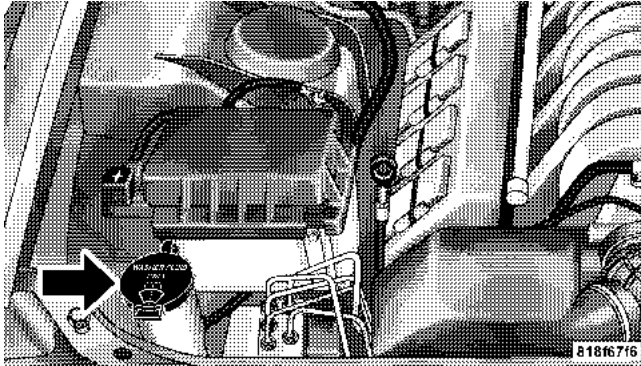

Washer Fluid Reservoir

WARNING!

Commercially available windshield washer solvents are flammable. They could ignite and burn you. Care must be exercised when filling or working around the washer solution.

POWER TILT/TELESCOPING STEERING COLUMN

This feature allows you to tilt the steering column upward or downward. It also allows you to lengthen or shorten the steering column. The power tilt/telescoping steering column lever is located below the multi-function lever on the steering column.

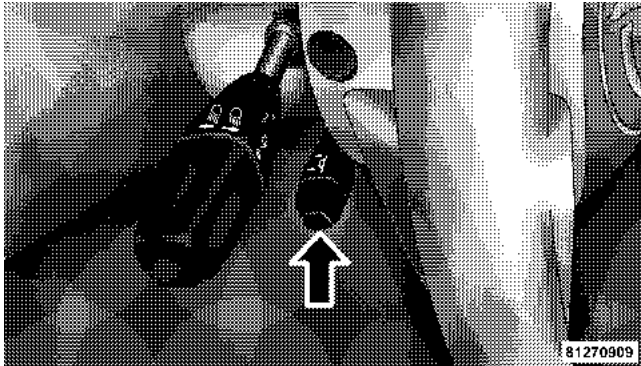

Power Tilt/Telescoping Steering

To tilt the steering column, move the lever up or down as desired. To lengthen or shorten the steering column, pull the lever toward you or push the lever away from you as desired.

NOTE: For vehicles equipped with Driver Memory Seat, you can use your remote keyless entry transmitter or the memory switch on the driver's door panel to return the tilt/telescopic steering column to pre-programmed positions. Refer to "Driver Memory Seat" in this section for details.

3

WARNING!

Moving the steering column while the vehicle is moving is dangerous. Without a stable steering column, you could lose control of the vehicle and have an accident. Adjust the column only while the vehicle is stopped.

ADJUSTABLE PEDALS

The adjustable pedals system is designed to allow a greater range of driver comfort for steering wheel tilt and seat position. This feature allows both the brake and accelerator pedal to move toward or away from the driver to provide improved position with the steering wheel. The switch is located on the front side of the driver's seat cushion side shield.

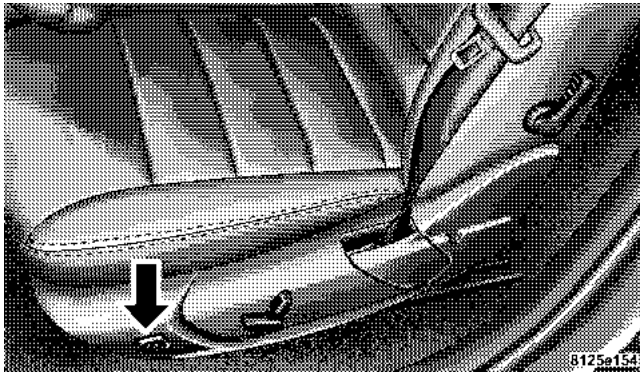

Adjustable Pedal Switch

Press the switch forward to move the pedals forward (toward the front of the vehicle).

Press the switch rearward to move the pedals rearward (toward the driver).

- The pedals can be adjusted with the ignition OFF.
- The pedals can be adjusted while driving.
- The pedals **cannot** be adjusted when the vehicle is in R (Reverse) or when the Speed Control is ON. One of the following messages will display in the Electronic Vehicle Information Center (EVIC) if a pedal adjustment is attempted when the system is locked out: "Adjustable Pedal Disabled — Cruise Control Engaged" or "Adjustable Pedal Disabled — Vehicle In Reverse."

NOTE: For vehicles equipped with Driver Memory Seat, you can use your remote keyless entry transmitter or the memory switch on the driver's door panel to return the adjustable pedals to pre-programmed positions. Refer to "Driver Memory Seat" in this section for details.

CAUTION!

Do not place any article under the adjustable pedals or impede its ability to move as it may cause damage to the pedal controls. Pedal travel may become limited if movement is stopped by an obstruction in the adjustable pedal's path.

ELECTRONIC SPEED CONTROL

When engaged, this device takes over the accelerator operation at speeds greater than 25 mph (40 km/h).

Electronic Speed Control Operation

The speed control lever (located on the left side of the steering column) operates the system.

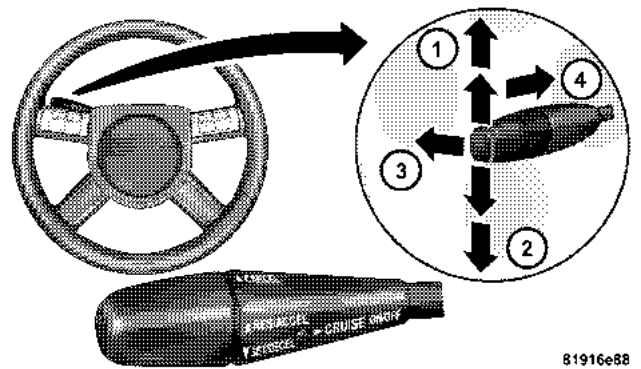

- 1 — RESUME/ACCEL
- 2 — SET/DECEL
- 3 — CANCEL
- 4 — ON/OFF

81916e88

To Activate:

Push the speed control lever inward (toward the steering column) and release (“ON/OFF”). The indicator light in the lever (and in the instrument cluster on some models) will illuminate to show that the speed control system is ON. To turn the system OFF, push the lever inward (toward the steering column) again and release. At this time, the system and the indicator light will turn off.

WARNING!

Leaving the Electronic Speed Control system on when not in use is dangerous. You could accidentally set the system or cause it to go faster than you want. You could lose control and have an accident. Always leave the system OFF when you aren’t using it.

To Set At A Desired Speed:

When the vehicle reaches the speed desired, push the lever down and release (“SET/DECEL”). Remove your foot from the accelerator pedal and the vehicle will operate at the selected speed.

NOTE:

- Speed control will only function in third, fourth, or fifth gear when in the Autostick® Mode (if equipped).
- The speed control may not engage if a different size tire is installed on one wheel, such as the compact spare tire.

To Deactivate:

The system will disable Electronic Speed Control without erasing the memory if you:

- Softly tap the brake pedal.
- Depress the brake pedal.
- Push the speed control lever away from you (“CANCEL”).

Pushing and releasing the lever (“ON/OFF”) or turning off the ignition erases the set speed from memory.

To Resume Speed:

If you deactivated the speed control without erasing the set speed from memory and your vehicle speed is above 20 mph (32 km/h) you can resume the previous set

speed. To do so, push the lever up and release (RES/ACCEL), and then remove your foot from the accelerator pedal.

To Vary the Speed Setting:

When the speed control is set, you can increase speed by pushing the lever up and holding ("RES/ACCEL"). When the lever is released, a new set speed will be established.

Pushing the lever up and releasing ("RES/ACCEL") once will result in a 1 mph (1.6 km/h) speed increase. Each time the lever is pushed up and released, speed increases so that pushing the lever up and releasing three times will increase speed by 3 mph (4.8 km/h), etc.

To decrease speed while speed control is set, push the lever down and hold ("SET/DECEL"). Release the lever when the desired speed is reached, and a new set speed will be established.

Pushing down and releasing the lever ("SET/DECEL") once will result in a 1 mph (1.6 km/h) speed decrease. Each time the lever is pushed down and released, speed decreases.

To Accelerate For Passing:

Depress the accelerator as you would normally. When the pedal is released, the vehicle will return to the set speed.

NOTE: The speed control system maintains speed up and down hills. A slight speed change on moderate hills is normal.

Four speed automatic transmissions will experience a downshift to 3rd gear while climbing uphill or descending downhill. This downshift to 3rd gear is necessary to maintain vehicle set speed.

On steep hills, a greater speed loss or gain may occur so it may be preferable to drive without speed control.

WARNING!

Speed Control can be dangerous where the system can't maintain a constant speed. Your vehicle could go too fast for the conditions, and you could lose control. An accident could be the result. Don't use Speed Control in heavy traffic or on roads that are winding, icy, snow-covered, or slippery.

REAR PARK ASSIST SYSTEM

The Rear Park Assist System is a driver aid that senses for obstacles behind the vehicle. Refer to the Warnings, Cautions, and Notes in this section for system limitations and usage recommendations.

The Rear Park Assist System is active when the driver shifts the transmission into the R (Reverse) position, and the parking brake is not applied, and the vehicle speed is less than 10 mph (16 km/h).

The system can be turned on or off when the vehicle is in PARK through the Electronic Vehicle Information Center (EVIC). For details, refer to “Personal Settings (Customer Programmable Features)” under “Electronic Vehicle Information Center (EVIC)” in Section 4 of this manual.

The system uses four sensors located in the rear bumper to scan for obstacles up to 59 inches (150 cm) away from the rear bumper fascia. The warning display located above the rear window provides both visible and audible warnings to indicate the range of the object.

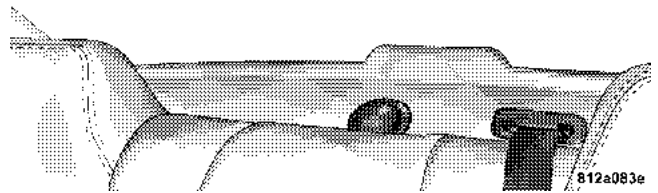
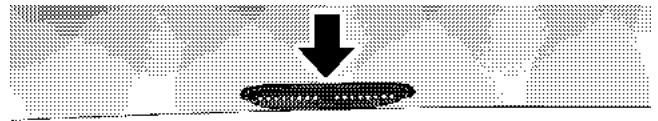

Rear Park Assist Indicator

The warning display contains two sets of yellow and red LEDs, one set to warn of obstacles behind the left rear of the vehicle and the other set to warn of obstacles behind the right rear of the vehicle. The driver can view the LEDs either through the rear view mirror or by looking at the display above the rear window.

The system dimly illuminates the two outer most yellow LEDs when it is ON and detecting no obstacles. The following chart shows the warning display operation when the system is detecting an obstacle:

WARNING DISPLAY DISTANCES

| DISPLAY LED | OBSTACLE DISTANCE FROM: | | LED COLOR | AUDIBLE SIGNAL |
|-------------|-------------------------|------------------|-----------|-----------------------------------|
| | REAR CORNERS | REAR CENTER | | |
| 1st LED | | 59 in. (150 cm) | Yellow | None |
| 2nd LED | | 47 in. (120 cm) | Yellow | None |
| 3rd LED | | 39 in. (100 cm) | Yellow | None |
| 4th LED | 31.5 in. (80 cm) | 31.5 in. (80 cm) | Yellow | None |
| 5th LED | 25.5 in. (65 cm) | 25.5 in. (65 cm) | Yellow | None |
| 6th LED | 20 in. (50 cm) | 20 in. (50 cm) | Yellow | None |
| 7th LED | 16 in. (40 cm) | 16 in. (40 cm) | Red | at 12 in. (30 cm) Intermittent |
| 8th LED | 6 in. (15 cm) | 12 in. (30 cm) | Red | at 8 in. (20 cm) Continuous |

NOTE: The Rear Park Assist system will MUTE the radio, if on, when the system is sounding an audio tone.

WARNING!

- Drivers must be careful when backing up even when using the Rear Park Assist System. Always check carefully behind your vehicle, look behind you, and be sure to check for pedestrians, animals, other vehicles, obstructions, and blind spots before backing up. You are responsible for safety and must continue to pay attention to your surroundings. Failure to do so can result in serious injury or death.
- Before using the Rear Park Assist System, it is strongly recommended that the ball mount and hitch ball assembly is disconnected from the vehicle when the vehicle is not used for towing. Failure to do so can result in injury or damage to vehicles or obstacles because the hitch ball will be much closer to the obstacle than the rear fascia when the warning display turns the red LEDs ON. Also, the sensors could detect the ball mount and hitch ball assembly, depending on its size and shape, giving a false indication that an obstacle is behind the vehicle.

CAUTION!

- The Rear Park Assist System is only a parking aid and it is unable to recognize every obstacle, including small obstacles. Parking curbs might be temporarily detected or not detected at all. Obstacles located above or below the sensors will not be detected when they are in close proximity.
- The vehicle must be driven slowly when using the Rear Park Assist System to be able to stop in time when the obstacle is detected. It is recommended that the driver looks over his/her shoulder when using the Rear Park Assist System.

NOTE:

- Ensure that the rear bumper is free of dirt and debris to keep the system operating properly.
- Jackhammers, large trucks, and other vibrations could affect the performance of the system.

If "Service Park Assist System" appears in the Electronic Vehicle Information Center (EVIC) after making sure the rear bumper is clean please see your authorized dealer.

OVERHEAD CONSOLE

The overhead console contains courtesy/reading lights, an optional universal garage door opener (HomeLink®), storage for sunglasses, and an optional power sunroof switch.

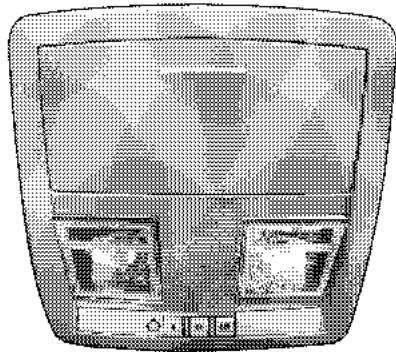

Overhead Console

8125e101

Courtesy/Reading Lights

At the forward end of the console are two courtesy/reading lights.

Press the lens to turn on the light. Press it a second time to turn off the light.

These lights also turn on when a door is opened, or when the unlock button on the remote keyless entry transmitter is pressed, or when the dimmer control is turned fully upward, past the second detent.

Sunglasses Storage

At the rear of the console, a compartment is provided for the storage of a pair of sunglasses.

The storage compartment access is a "push/push" design. Push the finger depression on the overhead console to open. Push the finger depression to close.

GARAGE DOOR OPENER (HomeLink®)

The HomeLink® Universal Transceiver replaces up to three remote controls (hand held transmitters) that operate devices such as garage door openers, motorized gates, or home lighting. It triggers these devices at the push of a button. The Universal Transceiver operates off your vehicle's battery and charging system; no batteries are needed.

NOTE: The HomeLink® Universal Transceiver is disabled when the Vehicle Security Alarm is active.

For additional information on HomeLink®, call 1-800-355-3515, or on the internet at www.homelink.com.

WARNING!

- A moving garage door can cause injury to people and pets in the path of the door. People or pets could be seriously or fatally injured. Only use this transceiver with a garage door opener that has a "stop and reverse" feature as required by federal safety standards. This includes most garage door opener models manufactured after 1982. Do not use a garage door opener without these safety features it could cause injury or death. Call toll-free 1-800-355-3515 or, on the Internet at www.homelink.com for safety information or assistance.
- Vehicle exhaust contains carbon monoxide, a dangerous gas. Do not run the vehicle's exhaust while training the transceiver. Exhaust gas can cause serious injury or death.
- Your motorized door or gate will open and close while you are training the Universal Transceiver. Do not train the transceiver if people or pets are in the path of the door or gate. A moving door or gate can cause serious injury or death to people and pets or damage to objects.

Programming HomeLink

NOTE: When programming a garage door opener, it is advised to park outside the garage. It is also recommended that you install a new battery in the hand-held transmitter of the device being programmed. This will allow for quicker training and accurate transmission of the radio-frequency signal.

The Electronic Vehicle Information Center (EVIC) features a driver-interactive display, which includes HomeLink system messages. The EVIC is located in the upper part of the cluster between the speedometer and tachometer.

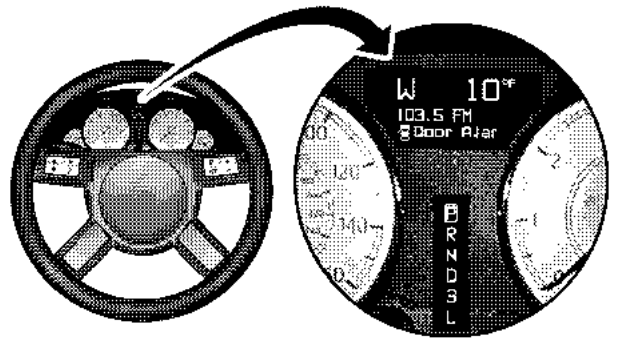

818c9c36

Electronic Vehicle Information Center

1. Press and hold the two outer HomeLink buttons. Release the buttons only when the EVIC displays "Channels Cleared" (after 20 seconds); however, **do not** hold the buttons for longer than 30 seconds. **Do not** repeat this step if programming a second or third hand-held transmitter to the remaining HomeLink buttons.

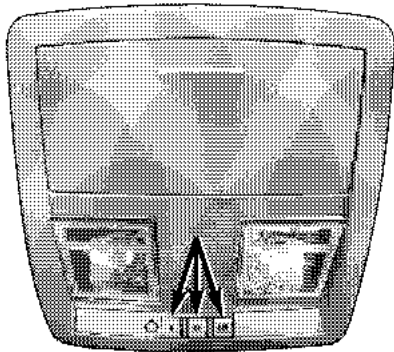

8125e19b

HomeLink Buttons

2. Position the end of your hand-held transmitter 1-3 inches (3-8 cm) away from the HomeLink buttons.

3. Simultaneously press and hold the HomeLink button (that you want to train) and the hand-held transmitter button. **Do not release the buttons until Step 4 is complete.**

NOTE: Some gate operators and garage door openers may require you to replace this Programming Step 3 with procedures noted under "Gate Operator/Canadian Programming."

4. The EVIC will display "Channel X Training" (where X is Channel 1, 2, or 3). Release both buttons after the EVIC displays "Channel X Trained."

NOTE: If the EVIC displays "Did Not Train," repeat Steps 2-4.

5. Press and hold the just trained HomeLink button and observe the EVIC display. If the EVIC displays "Channel X Transmit" (where X is Channel 1, 2, or 3), then programming is complete, and your device should activate when the HomeLink button is pressed and released.

NOTE: To program the remaining two HomeLink buttons, begin with "Programming" **Step 2. Do not repeat Step 1.**

NOTE: If your garage door opener fails to respond to the programmed HomeLink® Universal Transceiver, and your garage door opener is manufactured after 1995, it may have a multiple security code system (rolling code system). Please proceed to Steps 6–8 to complete the programming of a rolling code equipped device (most common garage door openers require this step).

6. At the garage door opener receiver (motor-head unit) in the garage, locate the "learn" or "smart" button. This can usually be found where the hanging antenna wire is attached to the motor-head unit.

7. Firmly press and release the "learn" or "smart" button. (The name and color of the button may vary by manufacturer.)

NOTE: You will have 30 seconds in which to initiate Step 8.

8. Return to the vehicle and firmly **press, hold for two seconds, and release** the programmed HomeLink button. Repeat the "**press/hold/release**" sequence a second time, and, depending on the brand of the garage door opener

(or other rolling code equipped device), repeat this sequence a third time to complete the programming.

HomeLink should now activate your rolling code equipped device.

NOTE: To program the remaining two HomeLink buttons, begin with "Programming" **Step 2. Do not repeat Step 1.** For questions or comments, please contact HomeLink at www.homelink.com or 1-800-355-3515.

Canadian Programming/Gate Programming

Canadian radio-frequency laws require transmitter signals to "time-out" (or quit) after several seconds of transmission, which may not be long enough for HomeLink to pick up the signal during programming. Similar to this Canadian law, some U.S. gate operators are designed to "time-out" in the same manner.

If you live in Canada or you are having difficulties programming a gate operator by using the "Programming" procedures (regardless of where you live), **replace "Programming HomeLink" Step 3** with the following:

NOTE: If programming a garage door opener or gate operator, it is advised to unplug the device during the "cycling" process to prevent possible overheating.

3. Continue to press and hold the HomeLink button while you **press and release** your hand-held transmitter **every two seconds** until the frequency signal is accepted successfully by HomeLink. The EVIC will display "Channel X Trained" (where X is Channel 1, 2, or 3). Proceed with "Programming" Step 4 to complete the procedure.

Using HomeLink

To operate, simply press and release the programmed HomeLink button. Activation will now occur for the trained device (i.e. garage door opener, gate operator, security system, entry door lock, home/office lighting, etc.). For convenience, the hand-held transmitter of the device may also be used at any time. In the event that there are still programming difficulties or questions, contact HomeLink at: **www.homelink.com** or **1-800-355-3515**.

Erasing HomeLink Buttons

To erase programming from the three buttons (individual buttons cannot be erased but can be "reprogrammed" - note below), follow the step noted:

- Press and hold the two outer HomeLink buttons. Release the buttons only when the EVIC displays "Channels Cleared" (after 20 seconds); however, **do not** hold the buttons for longer than 30 seconds. HomeLink is now in the train (or learning) mode and can be programmed at any time beginning with "Programming" Step 2.

Reprogramming a Single HomeLink Button

To program a device a previously trained HomeLink button, follow these steps:

1. Press and hold the desired HomeLink button. **Do NOT** release the button.
2. The EVIC will display "Channel X Transmit" (where X is Channel 1, 2, or 3) for 20 seconds and then change to "Channel X Training." Without releasing the HomeLink button, proceed with "Programming" Step 2.

For questions or comments, contact HomeLink at www.homelink.com or 1-800-355-3515.

Security

If you sell your vehicle, be sure to erase the frequencies by following the “Erasing HomeLink Buttons” instructions in this section.

This device complies with part 15 of FCC rules and with RSS-210 of Industry Canada. Operation is subject to the following conditions:

- This device may not cause harmful interference.
- This device must accept any interference that may be received including interference that may cause undesired operation.

NOTE: Changes or modifications not expressly approved by the party responsible for compliance could void the user’s authority to operate the equipment.

HomeLink® is a trademark owned by Johnson Controls, Inc.

POWER SUNROOF — IF EQUIPPED

The power sunroof switch is located between the sun visors on the overhead console.

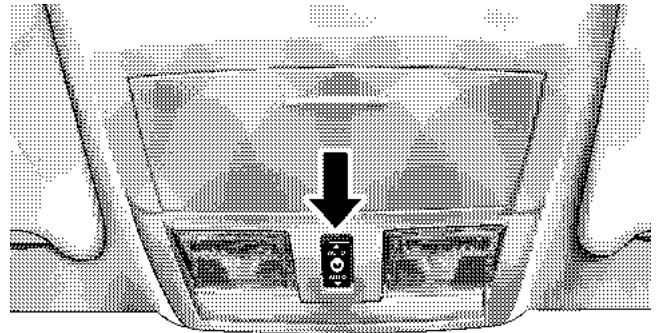

81351e5e

Power Sunroof Controls

WARNING!

- **Never leave children in a vehicle, with the keys in the ignition switch. Occupants, particularly unattended children, can become entrapped by the power sunroof while operating the power sunroof switch. Such entrapment may result in serious injury or death.**
- **In an accident, there is a greater risk of being thrown from a vehicle with an open sunroof. You could also be seriously injured or killed. Always fasten your seat belt properly and make sure all passengers are properly secured too.**
- **Do not allow small children to operate the sunroof. Never allow fingers or other body parts, or any object to project through the sunroof opening. Injury may result.**

Opening Sunroof - Express

Press the switch rearward and release, and the sunroof will open automatically from any position. The sunroof will open fully and then stop automatically. This is called Express Open. During Express Open operation, any movement of the sunroof switch will stop the sunroof.

Closing Sunroof - Express

Press the switch forward and release, and the sunroof will close automatically from any position. The sunroof will close fully and stop automatically. This is called Express Close. During Express Close operation, any movement of the switch will stop the sunroof.

Pinch Protect Feature

This feature will detect an obstruction in the opening of the sunroof during Express Close operation. If an obstruction in the path of the sunroof is detected, the sunroof will automatically retract. Remove the obstruction if this occurs. Next, press the switch forward and release to Express Close.

Pinch Protect Override

If a known obstruction (ice, debris, etc.) prevents closing, press the switch forward and hold for two seconds after the reversal occurs. This allows the sunroof to move towards the closed position.

NOTE: Pinch protection is disabled while the switch is pressed.

Venting Sunroof - Express

Press and release the "V" button, and the sunroof will open to the vent position. This is called Express Vent, which operates regardless of sunroof position. During Express Vent operation, any movement of the switch will stop the sunroof.

Sunshade Operation

The sunshade can be opened manually. However, the sunshade will open automatically as the sunroof opens.

NOTE: The sunshade cannot be closed if the sunroof is open.

Wind Buffeting

Wind buffeting can be described as the perception of pressure on the ears or a helicopter type sound in the ears. Your vehicle may exhibit wind buffeting with the windows down, or the sunroof (if equipped) in certain open or partially open positions. This is a normal occurrence and can be minimized. If the buffeting occurs with the rear windows open, then open the front and rear windows together to minimize the buffeting. If the buffeting occurs with the sunroof open, then adjust the sunroof opening to minimize the buffeting or open any window.

Sunroof Maintenance

Use only a non-abrasive cleaner and a soft cloth to clean the glass panel.

Ignition Off Operation

The power sunroof switch will remain active for up to 60 minutes after the ignition switch is turned off. Opening either front door will cancel this feature. The time for this feature is programmable. For details, refer to "Delay Power Off to Accessories Until Exit," under "Personal

Settings (Customer Programmable Features),” under “Electronic Vehicle Information Center (EVIC)” in Section 4 of this manual.

Sunroof Fully Closed

Press the switch forward and release to ensure that the sunroof is fully closed.

ELECTRICAL POWER OUTLETS

There are two 12-volt electrical outlets on this vehicle. Both of the outlets are protected by a fuse.

The 12-volt power outlet next to the ash receiver tray (if equipped with an optional Smoker’s Package) has power available only when the ignition is on. This outlet will also operate a conventional cigar lighter unit.

NOTE: If desired, the power outlet next to the ash receiver tray (if equipped) can be converted by your authorized dealer to provide power with the ignition switch in the LOCK position.

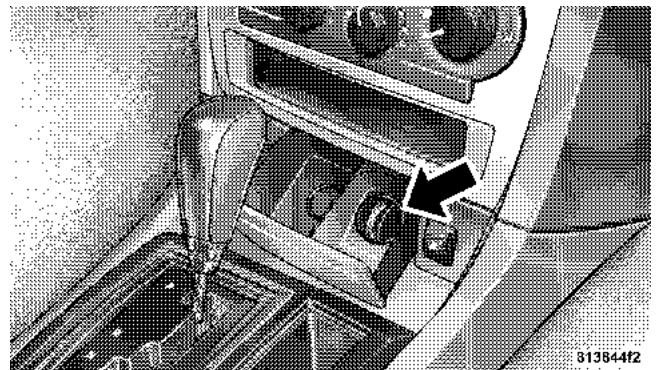

Front Power Outlet

WARNING!

Do not place ashes inside the cubby bin located on the center console on vehicles not equipped with the ash receiver tray. A fire leading to bodily injury could result.

The center console outlet is powered directly from the battery (power available at all times). Items plugged into this outlet may discharge the battery and/or prevent engine starting.

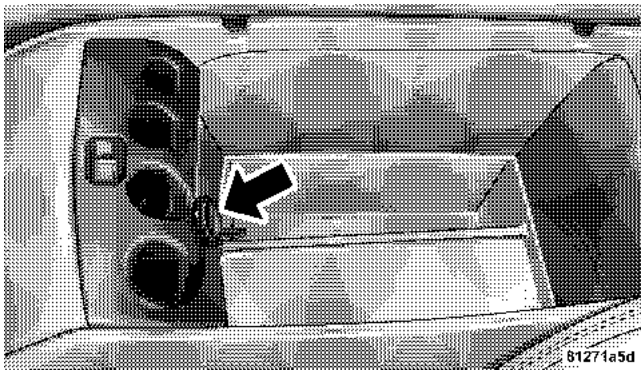

Center Console Power Outlet

Electrical Outlet Use With Engine Off

CAUTION!

- Many accessories that can be plugged in draw power from the vehicle's battery, even when not in use (i.e. cellular phones, etc.). Eventually, if plugged in long enough, the vehicle's battery will discharge sufficiently to degrade battery life and/or prevent engine starting.
- Accessories that draw higher power (i.e. coolers, vacuum cleaners, lights, etc.); will degrade the battery even more quickly. Only use these intermittently and with greater caution.
- After the use of high power draw accessories, or long periods of the vehicle not being started (with accessories still plugged in), the vehicle must be driven a sufficient length of time to allow the alternator to recharge the vehicle's battery.
- Power outlets are designed for accessory plugs only. Do not hang any type of accessory or accessory bracket from the plug. Improper use of the power outlet can cause damage not covered by your warranty.

CUP HOLDERS

Front Seat Cup Holders

The cup holders are located in the forward edge of the center console.

Push down on the cover as shown to expose the cup holders. Close the cover when the cup holders are no longer needed.

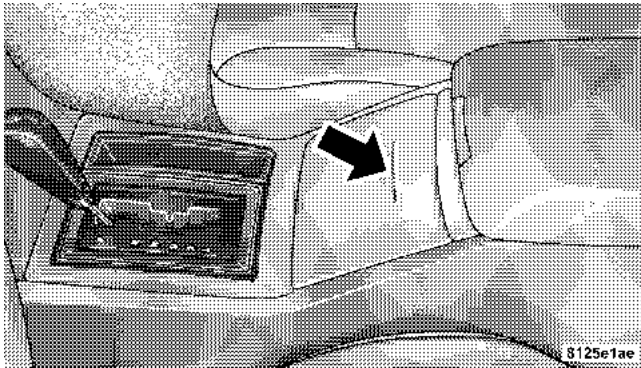

Front Seat Cup Holders

Rear Seat Cup Holders

The rear seat cup holders are located in the center armrest between the rear seats. The cup holders are positioned forward in the armrest and side-by-side to provide convenient access to beverage cans or bottles while maintaining a resting place for the rear occupants' elbows.

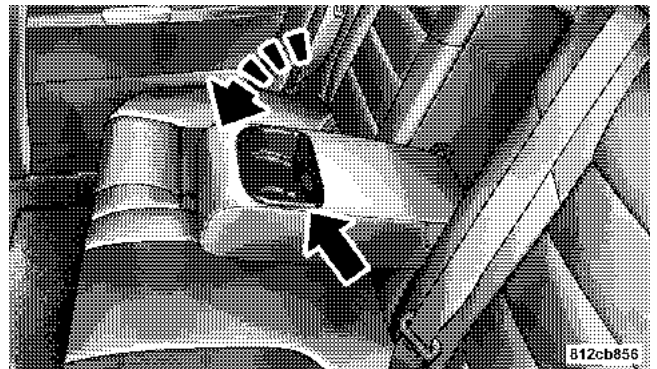

Rear Seat Cup Holders

STORAGE

Console Features

The center console contains a large storage bin. The storage bin contains a four-slot coin holder (designed to hold various size coins) and a rubber mat at the bottom of the bin for noise control. The bin is large enough to hold a portable AC/DC converter to power laptops, games, or other electrical equipment. Two slots at the top right side of the bin provide clearance for power cords to pass conveniently out of the bin with the lid closed. This feature is ideal for games, laptops, cell phones, or other electrical equipment. The console's front-opening lid allows for easy access to the storage bin for both the driver and the front passenger. The inside portion of the arm rest lid contains a penholder, a tissue holder, and a tire gauge holder.

In addition to the internal storage, the console contains two shift bezel cubby bins with rubber mats for holding small items. For vehicles not equipped with navigation radio, the console also contains an extra storage bin located below the climate control, which holds up to four CD jewel cases.

Cargo Area

The 60/40 split-folding rear seat provides cargo-carrying versatility. The seatbacks fold down easily by pulling nylon tabs between the seatbacks and the bolsters. When the seats are folded down, they provide a continuous, nearly flat extension of the load floor.

When the seatback is folded to the upright position, make sure it is latched by strongly pulling on the top of the seatback above the seat strap.

WARNING!

- Be certain that the seatback is securely locked into position. If the seatback is not securely locked into position, the seat will not provide the proper stability for child seats and/or passengers. An improperly latched seat could cause serious injury.
- The cargo area in the rear of the vehicle (with the rear seatbacks in the locked-up or folded down position) should not be used as a play area by children when the vehicle is in motion. They could be seriously injured in an accident. Children should be seated and using the proper restraint system.
- To help protect against personal injury, passengers should not be seated in the rear cargo area. The rear cargo space is intended for load carrying purposes only, not for passengers, who should sit in seats and use seat belts.

WARNING!

- The weight and position of cargo and passengers can change the vehicle center of gravity and vehicle handling. To avoid loss of control resulting in personal injury, follow these guidelines for loading your vehicle:
 - Always place cargo evenly on the cargo floor. Put heavier objects as low and as far forward as possible.
 - Place as much cargo as possible in front of the rear axle. Too much weight or improperly placed weight over or behind the rear axle can cause the rear of the vehicle to sway.
 - Do not pile luggage or cargo higher than the top of the seatback. This could impair visibility or become a dangerous projectile in a sudden stop or collision.

LOAD LEVELING SYSTEM

The automatic load leveling system will provide a level-riding vehicle under most passenger and cargo loading conditions.

A hydraulic pump contained within the shock absorbers raises the rear of the vehicle to the correct height. It takes approximately 1 mile (1.6 km) of driving for the leveling to complete depending on road surface conditions.

If the leveled vehicle is not moved for approximately 15 hours, the leveling system will bleed itself down. The vehicle must be driven to reset the system.

UNDERSTANDING YOUR INSTRUMENT PANEL

CONTENTS

| | | | |
|--|-----|---|-----|
| ■ Instrument Panel And Controls | 134 | □ System Warnings (Customer Information Features) | 153 |
| ■ Premium Instrument Cluster | 135 | □ Personal Settings (Customer Programmable Features) | 153 |
| ■ Instrument Cluster Descriptions | 136 | ■ Setting The Analog Clock | 157 |
| ■ Electronic Vehicle Information Center (EVIC) | 144 | ■ Radio General Information | 158 |
| □ Electronic Vehicle Information Center (EVIC) Displays | 145 | □ Radio Broadcast Signals | 158 |
| □ Trip Functions | 147 | □ Two Types Of Signals | 158 |
| □ Compass Display | 149 | □ Electrical Disturbances | 158 |
| □ Telephone — If Equipped | 150 | □ AM Reception | 158 |
| □ Navigation — If Equipped | 152 | □ FM Reception | 158 |

132 UNDERSTANDING YOUR INSTRUMENT PANEL

- Sales Code RAK – AM/FM/Cassette/CD (6-Disc) Radio With Optional Satellite Radio, Hands Free Phone, Video, MP3, And WMA Capabilities . . .159
 - Operating Instructions - Radio Mode159
 - Operating Instructions — Tape Player162
 - Seek Button163
 - Fast Forward (FF)163
 - Rewind (RW)163
 - Tape Eject163
 - Scan Button163
 - Changing Tape Direction163
 - Metal Tape Selection163
 - Pinch Roller Release163
 - Noise Reduction164
 - Operation Instructions - (CD Mode For CD Audio Play)164
 - Load/Eject Button (CD Mode For CD Audio Play)165
 - Notes On Playing MP3 Files166
 - Operation Instructions - (CD Mode For MP3 And WMA Audio Play)168
 - Load/Eject Button (CD Mode For MP3 And WMA Play)168
- Sales Code REC — AM/FM/CD (6-Disc) Radio With Navigation System170
 - Operating Instructions — Satellite Radio (If Equipped)171
 - REC Setting The Clock171
 - Audio Clock Display173
- Video Entertainment System (Sales Code XRV) — If Equipped174
 - Kicker Mobile Surround (Kms1)175
- Satellite Radio — If Equipped176
 - System Activation176

| | |
|---|---|
| <ul style="list-style-type: none"> □ Electronic Serial Number/Sirius Identification Number (ESN/SID)176 □ Selecting Satellite Mode In REF, RAQ, And RAK Radios177 □ Selecting a Channel177 □ Storing And Selecting Pre-Set Channels178 □ Using The PTY (Program Type) Button (If Equipped)178 □ PTY Button "Scan"178 □ PTY Button "Seek"178 □ Satellite Antenna179 □ Reception Quality179 ■ Remote Sound System Controls179 | <ul style="list-style-type: none"> □ Radio Operation180 □ Tape Player Operation181 □ CD Player Operation181 □ Satellite Radio Operation181 ■ Cassette Tape And Player Maintenance181 ■ CD/DVD Disc Maintenance182 ■ Radio Operation And Cellular Phones183 ■ Climate Controls183 <ul style="list-style-type: none"> □ Automatic Temperature Control183 □ Operating Tips188 ■ Rear Window Features191 <ul style="list-style-type: none"> □ Electric Rear Window Defroster191 |
|---|---|

INSTRUMENT PANEL AND CONTROLS

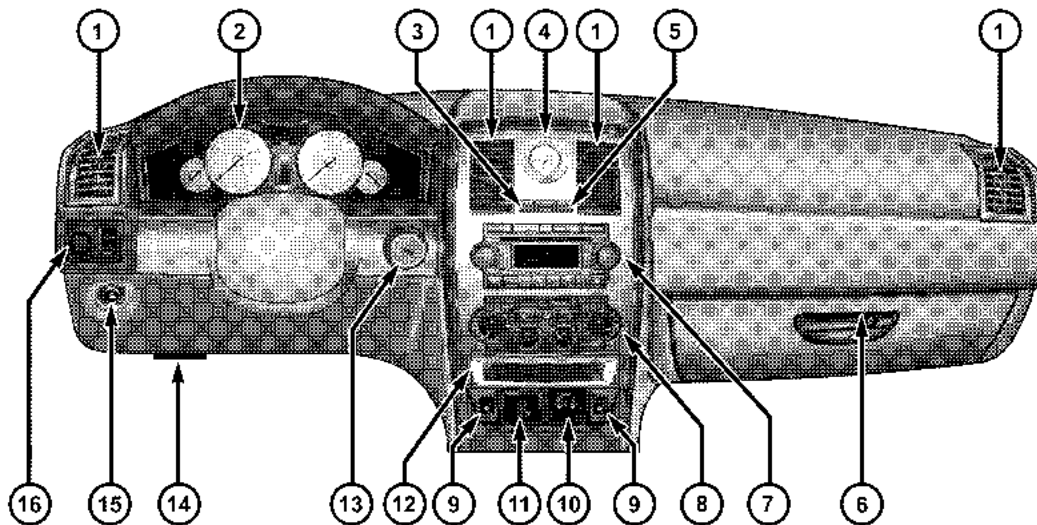

- | | | |
|---|---------------------------|---------------------------|
| 1 — Air Outlet | 7 — Radio | 13 — Ignition Switch |
| 2 — Instrument Cluster | 8 — Climate Control | 14 — Hood Release |
| 3 — Hazard Switch | 9 — Heated Seat Switch* | 15 — Trunk Release Switch |
| 4 — Analog Clock | 10 — Power Outlet | 16 — Headlight Switch |
| 5 — Electronic Stability Program Off Button* / Traction Control System Off Button* | 11 — Ash Tray* | * If Equipped |
| 6 — Glove Box | 12 — Storage Compartment* | |

PREMIUM INSTRUMENT CLUSTER

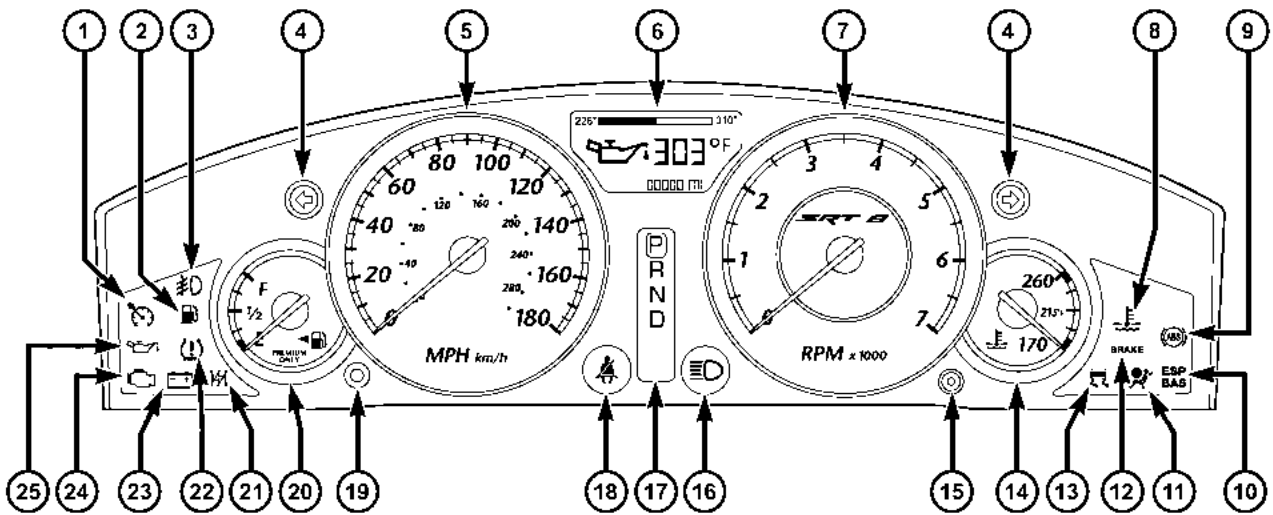

INSTRUMENT CLUSTER DESCRIPTIONS**1. Electronic Speed Control Indicator Light — If Equipped**

This light will turn on when the electronic speed control is ON. (See page 109 for more information.)

2. Low Fuel Indicator Light

This light will turn on and a single chime will sound when the fuel level drops to 1/8 tank. (See page 249 for more information.)

3. Front Fog Light Indicator

This light will turn on when the front fog lights are ON. (See page 98 for more information.)

4. Turn Signal Indicators

The arrow will flash with the exterior turn signal when the turn signal lever is operated.

NOTE: A continuous chime will sound if the vehicle is driven more than 1 mile (1.6 km) with either turn signal on.

NOTE: Check for a defective outside light bulb if either indicator flashes at a rapid rate. (See page 98 for more information.)

5. Speedometer

Indicates vehicle speed.

6. Electronic Vehicle Information Center Display

This display shows the Electronic Vehicle Information Center (EVIC) messages when the appropriate conditions exist. (See page 144 for more information.)

Loose Fuel Filler Cap

If the vehicle diagnostic system determines that the fuel filler cap is loose, improperly installed, or damaged, a “Check Gascap” message will display in the Electronic Vehicle Information Center (EVIC). Tighten the fuel filler cap properly and press the odometer reset button to turn off the message. If the problem continues, the message will appear the next time the vehicle is started.

A loose, improperly installed, or damaged fuel filler cap may also turn on the Malfunction Indicator Light (MIL). (See page 272 for more information.)

7. Tachometer

The red segments indicate the maximum permissible engine revolutions-per-minute (r.p.m. x 1000) for each gear range. Ease up on the accelerator before reaching the red area.

8. Engine Temperature Warning Light



This light will turn on and a single chime will sound to warn of an overheated engine condition. When this light turns on, the engine temperature is critically hot. The vehicle should be turned off immediately and serviced as soon as possible. (See page 256 for more information.)

9. Anti-Lock Brake Light



This light monitors the Anti-Lock Brake System. The light will turn on when the ignition switch is turned to the ON position and may stay on for as long as four seconds.

If the ABS light remains on or turns on while driving, then the Anti-Lock portion of the brake system is not functioning and service is required. However, the conventional brake system will continue to operate normally if the BRAKE warning light is not on.

If the ABS light is on, the brake system should be serviced as soon as possible to restore the benefits of Anti-Lock brakes. If the ABS light does not turn on when the Ignition switch is turned to the ON position, have the light inspected by an authorized dealer. (See page 211 for more information.)

10. Electronic Stability Program (ESP) / Brake Assist System (BAS) Malfunction Indicator Light



The yellow ESP/BAS malfunction indicator light will turn on when the key in the ignition switch is turned to the "ON" position. The light should go out with the engine running. If the light remains on after several ignition cycles, and the vehicle has been driven several miles at speeds greater than 30 mph (48 km/h), see your authorized dealer as soon as possible to have the problem diagnosed and corrected. (See page 214 for more information.)

11. Airbag Warning Light



This light will turn on for 6 to 8 seconds as a bulb check when the ignition switch is first turned ON. If the light is either not on

during starting, or stays on, or turns on while driving, then have the system inspected at your authorized dealer as soon as possible. (See page 46 for more information.)

12. Brake System Warning Light

This light monitors various brake functions, including brake fluid level and parking brake application. If the brake light turns on, it may indicate that the parking brake is applied, that the brake fluid level is low, or that there is a problem with the anti-lock brake system.

The dual brake system provides a reserve braking capacity to a portion of the hydraulic system in the event of a failure. Failure of either half of the dual brake system is indicated by the Brake Warning Light, which will turn on when the brake fluid level in the master cylinder drops below a specified level.

The light will remain on until the cause is corrected.

NOTE: The light may flash momentarily during sharp cornering maneuvers due to a change in fluid level. If so, the vehicle should have service performed and the brake fluid level checked.

Immediate repair is necessary if brake failure is indicated.

WARNING!

Driving a vehicle with the brake light on is dangerous. Part of the brake system may have failed. It will take longer to stop the vehicle. You could have an accident. Have the vehicle checked immediately.

Vehicles equipped with Anti-Lock brakes (ABS) are also equipped with Electronic Brake Force Distribution (EBD). Both the Brake Warning Light and the ABS Light will turn on in the event of an EBD failure. Immediate repair of the ABS system is required in the event of an EBD failure.

The operation of the Brake Warning Light can be checked by turning the ignition switch from the OFF position to the ON position. The light should turn on for approximately two seconds and then turn off. The light will remain on if the parking brake is applied or if a brake fault is detected. If the parking brake is not applied and the light remains on, or if the light does not turn on, have the light inspected by an authorized dealer.

NOTE: The light will turn on when the ignition switch is in the ON position and the parking brake is applied. This light shows only that the parking brake is applied. It does not show the degree of brake application. (See page 211 for more information.)

13. *Electronic Stability Program (ESP)/Traction Control System (TCS) Indicator Light*



If this indicator light flashes during acceleration, ease up on the accelerator and apply as little throttle as possible. Adapt your speed and driving to the prevailing road conditions, and do not switch off the ESP. (See page 214 for more information.)

14. *Temperature Gauge*

The temperature gauge shows engine coolant temperature. Any reading within the normal range indicates that the engine cooling system is operating satisfactorily.

The gauge pointer will likely indicate a higher temperature when driving in hot weather, up mountain grades, or when towing a trailer. It should not be allowed to exceed the upper limits of the normal operating range.

CAUTION!

Driving with a hot cooling system could damage your vehicle. If temperature gauge reads 240°F (116°C) or greater, pull over and stop the vehicle. Idle the vehicle with the air conditioner turned off until the pointer drops back into the normal range 200–230°F (93–110°C). If the pointer remains at 240°F (116°C) or greater and you hear a chime, turn the engine off immediately, and call for service.

WARNING!

A hot engine cooling system is dangerous. You or others could be badly burned by steam or boiling coolant. You may want to call a service center if your vehicle overheats. If you decide to look under the hood yourself, see Section 7 of this manual. Follow the warnings under the Cooling System Pressure Cap paragraph.

15. Trip Odometer Button

Press this button to change the display from odometer to either of two trip odometer settings. The letter "A" or "B" will appear when in the trip odometer mode. Push in and hold the button for two seconds to reset the trip odometer to 0 miles (kilometers). The odometer must be in trip mode to reset it.

16. High Beam Light

 This light will turn on when the high beam headlights are ON. Push the Multi-Function

lever away from the steering wheel to switch the headlights to high beam. (See page 98 for more information.)

17. Transmission Range Indicator

This display indicator shows the automatic transmission gear selection.

18. Seat Belt Reminder Light

This light will turn on for 5 to 8 seconds as a bulb check when the ignition switch is first turned ON. A chime will sound if the driver's seat belt is unbuckled during the bulb check. The Seat Belt Warning Light will flash or remain on continuously if the driver's seat belt remains unbuckled after the bulb check or when driving. (See page 35 for more information.)

19. Vehicle Security Alarm (VSA) Indicator Light — If Equipped

The VSA indicator Light flashes rapidly when the VSA is arming, and slowly when the VSA is armed. (See page 15 for more information.)

20. Fuel Gauge

The pointer shows the level of fuel in the fuel tank when the ignition switch is in the ON position.

21. Electronic Throttle Control (ETC) Light

This light will turn on briefly as a bulb check when the ignition switch is turned ON. This light will also turn on while the engine is running if there is a problem with the Electronic Throttle Control system.

If the light comes on while the engine is running, safely bring the vehicle to a complete stop as soon as possible, place the gear selector in park, and cycle the ignition key. The light should turn off. If the light remains lit with the engine running, your vehicle will usually be drivable. However, see your dealer for service as soon as possible.

If the light is flashing when the engine is running, immediate service is required. In this case, you may experience reduced performance, an elevated/rough idle or engine stall, and your vehicle may require towing.

Also, have the system checked by an authorized dealer if the light does not come on during starting.

22. Tire Pressure Monitoring Telltale Light — If Equipped

Each tire, including the spare (if provided), should be checked monthly when cold and inflated to the inflation pressure recommended by the vehicle manufacturer on the vehicle placard or tire inflation pressure label. (If your vehicle has tires of a different size than the size indicated on the vehicle placard or tire inflation pressure label, you should determine the proper tire inflation pressure for those tires.)

As an added safety feature, your vehicle has been equipped with a tire pressure monitoring system (TPMS) that illuminates a low tire pressure telltale when one or more of your tires are significantly under-inflated. Accordingly, when the low tire pressure telltale illuminates, you should stop and check your tires as soon as possible, and inflate them to the proper pressure. Driving on a significantly under-inflated tire causes the tire to overheat and can lead to tire failure. Under-inflation also reduces fuel efficiency and tire tread life, and may affect the vehicle's handling and stopping ability.

Please note that the TPMS is not a substitute for proper tire maintenance, and it is the driver's responsibility to maintain correct tire pressure, even if under-inflation has not reached the level to trigger illumination of the TPMS low tire pressure telltale.

The Tire Pressure Monitoring Telltale Light will illuminate in the instrument cluster, and an audible chime will be activated when one or more tire pressures is low. The Tire Pressure Monitoring Telltale Light will flash on and off for 60 seconds when a system fault is detected. The flash cycle will repeat every ten minutes or until the fault condition is removed and reset. (See page 239 for more information.)

CAUTION!

The TPMS has been optimized for the original equipment tires and wheels. TPMS pressures and warning have been established for the tire size equipped on your vehicle. Undesirable system operation or sensor damage may result when using replacement equipment that is not of the same size, type, and/or style. After-market wheels can cause sensor damage. Do not use tire sealant from a can, or balance beads if your vehicle is equipped with a TPMS, as damage to the sensors may result.

23. Voltage Light

This light monitors the electrical system voltage. The light should turn on momentarily as the engine is started. If the light stays on or turns on while driving, it indicates a problem with the charging system. Immediate service should be obtained.

24. *Malfunction Indicator Light*



This light is part of an onboard diagnostic system called OBD. The OBD system monitors engine and automatic transmission control systems. The light will turn on when the key is in the ON position before engine start. If the light does not come on when turning the key from OFF to ON, have the condition checked promptly.

Certain conditions such as a loose or missing gas cap, poor fuel quality, etc. may illuminate the light after engine start. The vehicle should be serviced if the light stays on through several of your typical driving cycles. In most situations, the vehicle will drive normally and will not require towing.

The Malfunction Indicator Light flashes to alert you to serious conditions that could lead to immediate loss of power or severe catalytic converter damage. The vehicle should be serviced as soon as possible if this occurs. (See page 272 for more information.)

25. *Oil Pressure Warning Light*



This light shows low engine oil pressure. The light should turn on momentarily when the engine is started. If the light turns on while driving, stop the vehicle, and shut off the engine as soon as possible. A single chime will sound when this light turns on.

Do not operate the vehicle until the cause is corrected. This light does not show how much oil is in the engine. The engine oil level must be checked using the procedure shown in section 7. (See page 275 for more information.)

ELECTRONIC VEHICLE INFORMATION CENTER (EVIC)

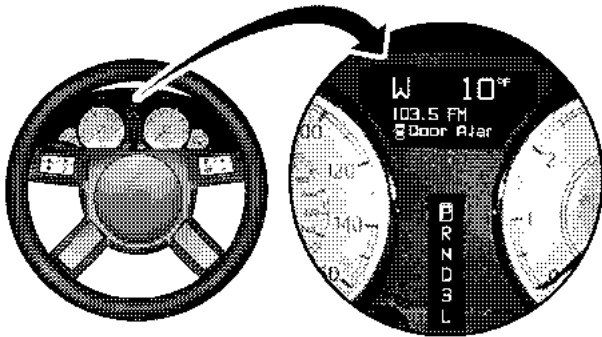

818c9c36

Electronic Vehicle Information Center

The Electronic Vehicle Information Center (EVIC) features a driver-interactive display. It is located in the upper part of the cluster between the speedometer and tachometer. Vehicles equipped with steering wheel mounted buttons (described in this section) are also equipped with the EVIC. The EVIC consists of the following:

- System Status

- Vehicle information warning message displays
- Tire Pressure Monitor System (if equipped)
- Personal Settings (customer programmable features)
- Compass display
- Outside temperature display
- Trip computer functions
- UConnect™ hands-free communication system displays (if equipped)
- Navigation system screens (if equipped)
- Audio mode display

The system allows the driver to select information by pressing the following buttons mounted on the steering wheel:



**MENU
Button**

Press and release the MENU button and the mode displayed will change between Trip Functions, Navigation (if equipped), System Status, Personal Settings, and Telephone (if equipped).



Press the FUNCTION SELECT button to accept a selection. The FUNCTION SELECT button also advances the radio to the next preset station, changes the side of the tape being played (if so equipped), or changes the current CD track being played (if so equipped) when the EVIC is in the Compass/Temp/Audio screen.



Press the SCROLL button to scroll through Trip Functions, Navigation (if equipped), System Status Messages, and Personal Settings (Customer Programmable Features). The SCROLL button also seeks up and down the radio stations, CD track numbers (if so equipped), or satellite radio channels (if so equipped) when the EVIC is in the Compass/Temp/Audio screen.



Press the AUDIO MODE button to select the Compass/Temp/Audio screen. This screen displays radio station frequencies, any one of twelve radio station preset frequencies, CD disc number, CD track number, tape, or any one of 200 Satellite radio channels depending on which radio is in the vehicle.

If Compass/Temp/Audio is already displayed when the AUDIO MODE button is pressed, then the radio mode will change from AM to FM, to Tape, to CD, or to Satellite (SAT) accordingly.

Electronic Vehicle Information Center (EVIC) Displays

When the appropriate conditions exist, the Electronic Vehicle Information Center (EVIC) displays the following messages:

- Turn Signal On (with a continuous warning chime if the vehicle is driven more than 1 mile [1.6 km] with either turn signal on)
- Left Front Turn Signal Light Out (with a single chime)
- Left Rear Turn Signal Light Out (with a single chime)
- Right Front Turn Signal Light Out (with a single chime)
- Right Rear Turn Signal Light Out (with a single chime)
- RKE Battery Low (with a single chime)
- Memory #1/#2 Profile Set

- Memory #1/#2 Profile Recall
- Memory System Disabled – Vehicle Not In Park (with a single chime)
- Memory System Disabled – Seat Belt Buckled (with a single chime)
- Personal Settings Not Available – Vehicle Not in Park
- Left/Right Front Door Ajar (one or more, with a single chime if speed is above 1 mph [1.6 km])
- Left/Right Rear Door Ajar (one or more, with a single chime if speed is above 1 mph [1.6 km])
- Door(s) Ajar (with a single chime if vehicle is in motion)
- Trunk Ajar (with a single chime)
- Low Washer Fluid (with a single chime)
- Adjustable Pedals Disabled – Cruise Engaged (with a single chime) — only available on vehicles equipped with memory seats.
- Adjustable Pedals Disabled – Vehicle In Reverse (with a single chime) — only available on vehicles equipped with memory seats.
- Channel 1, 2, OR 3 Transmit
- Channel 1, 2, OR 3 Training
- Channel 1, 2, OR 3 Trained
- Clearing Channels
- Channels Cleared
- Channels Defaulted
- Did Not Train
- Left Front Low Pressure (with a single chime). Refer to information on “Tire Pressure” and “Tire Pressure Monitor” in the “Starting And Operating” section of this manual.
- Left Rear Low Pressure (with a single chime). Refer to information on “Tire Pressure” and “Tire Pressure Monitor” in the “Starting And Operating” section of this manual.

- Right Front Low Pressure (with a single chime). Refer to information on “Tire Pressure” and “Tire Pressure Monitor” in the “Starting And Operating” section of this manual.
- Right Rear Low Pressure (with a single chime). Refer to information on “Tire Pressure” and “Tire Pressure Monitor” in the “Starting And Operating” section of this manual.
- Check TPM System (with a single chime). Refer to information on “Tire Pressure Monitor” in the “Starting And Operating” section of this manual.
- Check Gascap (refer to “Adding Fuel” in Section 5 of this manual for more details)
- Service Park Assist System (with a single chime)
- Upshift
- Distance To Empty
- Trip A
- Trip B
- Elapsed Time
- Display Units of Measure in

Trip Functions

Press and release the MENU button until one of the following Trip Functions displays in the EVIC:

- Average Fuel Economy

Press the SCROLL button to cycle through all the Trip Computer functions.

The Trip Functions mode displays the following information:

- ***Average Fuel Economy***

Shows the average fuel economy since the last reset. When the fuel economy is reset, the display will read “RESET” or show dashes for two seconds. Then, the history information will be erased, and the averaging will continue from the last fuel average reading before the reset.

- *Distance To Empty (DTE)*

Shows the estimated distance that can be traveled with the fuel remaining in the tank. This estimated distance is determined by a weighted average of the instantaneous and average fuel economy, according to the current fuel tank level. DTE cannot be reset through the FUNCTION SELECT button.

NOTE: Significant changes in driving style or vehicle loading will greatly affect the actual drivable distance of the vehicle, regardless of the DTE displayed value.

- When the DTE value is less than 30 miles (48 km) estimated driving distance, the DTE display will change to a text display of "LOW FUEL." This display will continue until the vehicle runs out of fuel. Adding a significant amount of fuel to the vehicle will turn off the "LOW FUEL" text and a new DTE value will display.

- *Trip A*

Shows the total distance traveled for trip A since the last reset.

- *Trip B*

Shows the total distance traveled for trip B since the last reset.

- *Elapsed Time*

Shows the total elapsed time of travel since the last reset when the ignition switch is in the ACC position. Elapsed time will increment when the ignition switch is in the ON or START position.

- *Display Units of Measure in:*

To make your selection, press and release the FUNCTION SELECT button until "US" or "METRIC" appears.

To Reset The Display

Reset will only occur while a resettable function is being displayed. Press and release the FUNCTION SELECT button once to clear the resettable function being displayed. To reset all resettable functions, press and release the FUNCTION SELECT button a second time within 3 seconds of resetting the currently displayed function (>Reset ALL will display during this 3 second window).

Compass Display



COM-
PASS
Button

The compass readings indicate the direction the vehicle is facing. Press and release the compass button to display one of eight compass readings and the outside temperature.

Automatic Compass Calibration

This compass is self-calibrating, which eliminates the need to set the compass manually. When the vehicle is new, the compass may appear erratic and the EVIC will display "CAL" until the compass is calibrated. You may also calibrate the compass by completing one or more 360° turns (in an area free from large metal or metallic objects) until the "CAL" message displayed in the EVIC turns off. The compass will now function normally.

Manual Compass Calibration

If the compass appears erratic and the "CAL" message does not appear in the EVIC display, you must put the compass into the Calibration Mode manually as follows:

1. Turn on the ignition switch.

2. Press and hold the compass button for approximately 2 seconds.

3. Press the SCROLL button until "Calibrate Compass" displays in the EVIC.

4. Press and release the FUNCTION SELECT button to start the calibration. The message "CAL" will display in the EVIC.

5. Complete one or more 360° turns (in an area free from large metal or metallic objects) until the "CAL" message turns off. The compass will now function normally.

Compass Variance

Compass Variance is the difference between magnetic North and Geographic North. In some areas of the country, the difference between magnetic and geographic North is great enough to cause the compass to give false readings. If this occurs, the compass variance must be set using the following procedure:

NOTE: Magnetic materials should be kept away from the overhead console. This is where the compass sensor is located.

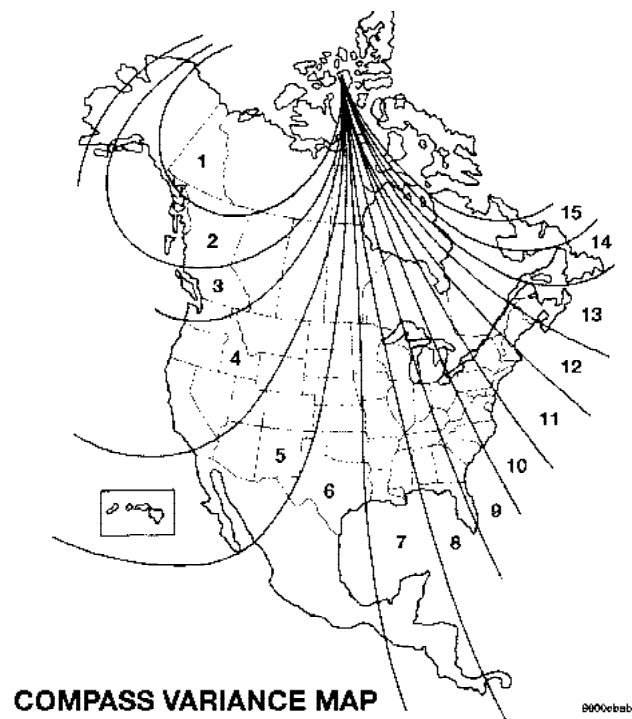

COMPASS VARIANCE MAP

©2006ebab

1. Turn the ignition switch ON.
2. Press and hold the compass button for approximately 2 seconds.
3. Press the SCROLL button until "Compass Variance" message and the last variance zone number displays in the EVIC.
4. Press and release FUNCTION SELECT button until the proper variance zone is selected according to the map.
5. Press and release the compass button to exit.

Telephone — If Equipped

Press and release the MENU button until "Telephone" displays in the EVIC.

When the appropriate conditions exist, the EVIC provides the following telephone information:

- Phone status: idle, voice mail, roaming, battery strength, and signal strength in increments of 20 percent.

- Call status: Incoming call, connecting, connected, air time in minutes and seconds, call ended, call failed, roaming, and no phone connection.
- UConnect Active.
- Caller ID phone number display.

When the appropriate conditions exist, and if supported by the cell phone, the EVIC will display the following telephone symbols:

 The EVIC displays this symbol to indicate the signal strength of the UConnect™ phone. The number of horizontal bars increases as the strength of the UConnect™ phone signal increases.

Signal Strength

 The EVIC displays this symbol to indicate an incoming call.

Incoming Call



Analog

The EVIC displays this symbol to indicate that the UConnect™ phone is currently in analog mode.



Roaming

The EVIC displays this symbol to indicate that the UConnect™ phone is currently roaming.



Voice Mail

The EVIC displays this symbol to indicate that you have voice mail.



Text Message

The EVIC displays this symbol to indicate a text message.



The EVIC displays this symbol to indicate the battery strength of the UConnect™ phone.

Battery Strength



The EVIC displays this symbol to indicate that a phone connection has been made.

Call in Progress



The EVIC displays this symbol to indicate that the UConnect™ phone is currently not available.

Phone Not Available

Navigation — If Equipped

Navigation Display Control

Press and release the MENU button until Navigation displays in the EVIC. When the Navigation System is On, the steering wheel buttons can be used to select the Map or Menu display on the Navigation Unit. When the Menu display is active, the SCROLL button can be used to scroll through the list, the FUNCTION SELECT button can be used to select an item, and the AUDIO MODE button can be used to return to the previous menu. When the Map display is active, pressing the FUNCTION SELECT button will change the Navigation Unit Display to the Menu.

Turn By Turn Directions

The EVIC displays turn-by-turn directions to a programmed destination when Turn by Turn Navigation is enabled through Personal Settings. When enabled, the EVIC displays the name of the approaching road at the top of the screen, followed by an arrow to indicate the direction to turn the vehicle, and a count down to indicate the distance to the turn.

NOTE: Refer to your “Navigation User’s Manual” for detailed operating instructions.

System Warnings (Customer Information Features)

Press and release the MENU button until "SYSTEM WARNINGS" displays in the EVIC. Then, press the SCROLL button to display anyone of the following choices:

- *Oil Temperature*

Shows the actual oil temperature.

- *Oil Pressure*

Shows the actual oil pressure.

- *Tire Pressure*

Shows the actual tire pressure for each tire (EXCLUDING THE SPARE TIRE).

Personal Settings (Customer Programmable Features)

Personal Settings allows the driver to set and recall features when the transmission is in PARK.

Press and release the MENU button until Personal Settings displays in the EVIC.

Use the SCROLL button to display one of the following choices:

"Language"

When in this display you may select one of five languages for all display nomenclature, including the trip functions and the navigation system (if equipped). Press the FUNCTION SELECT button while in this display to select English, Espanol, Deutsch, Italiano, or Francais. Then, as you continue, the information will display in the selected language.

NOTE: The EVIC will not change the UConnect™ language selection. Please refer to "Language Selection" in the HANDS-FREE COMMUNICATION (UConnect™) section of this manual for details.

"Lock Doors Automatically at 15 mph (24 Km/h)"

When ON is selected, all doors will lock automatically when the vehicle reaches a speed of 15 mph (24 km/h). To make your selection, press and release the FUNCTION SELECT button until "ON" or "OFF" appears.

“Unlock Doors Automatically on Exit”

When ON is selected, all doors will unlock when the vehicle is stopped and the transmission is in the P (Park) or N (Neutral) position and the driver’s door is opened. To make your selection, press and release the FUNCTION SELECT button until “ON” or “OFF” appears.

“Remote Key Unlock”

When **Driver Door 1st Press** is selected, only the driver’s door will unlock on the first press of the remote keyless entry unlock button. When **Driver Door 1st Press** is selected, you must press of the remote keyless entry unlock button twice to unlock the passenger’s doors. When **All Doors 1st Press** is selected, all of the doors will unlock on the first press of the remote keyless entry unlock button. To make your selection, press and release the FUNCTION SELECT button until “Driver Door 1st Press” or “All Doors 1st Press” appears.

“Recall Memory with Remote Key Unlock” — If Equipped

When ON is selected, you can use your Remote Keyless Entry Transmitter to recall one of two pre-programmed memory profiles. Each memory profile contains desired

position settings for the driver seat, side mirror, adjustable pedals (if equipped), and power tilt and telescopic steering column (if equipped), and a set of desired radio station presets. When OFF is selected, only the memory switch on the driver’s door panel will recall memory profiles. To make your selection, press and release the FUNCTION SELECT button until “ON” or “OFF” appears. Refer to “Driver Memory Seat” in Section 3 of this manual for more information.

“Sound Horn with Remote Key Lock”

When ON is selected, a short horn sound will occur when the remote keyless entry “Lock” button is pressed. This feature may be selected with or without the flash lights on lock/unlock feature. To make your selection, press and release the FUNCTION SELECT button until “ON” or “OFF” appears.

“Rain Sensing Intermittent Wipers”

When ON is selected, the system will automatically activate the windshield wipers if it senses moisture on the windshield. To make your selection, press and release

the FUNCTION SELECT button until "ON" or "OFF" appears. When OFF is selected, the system reverts to the standard intermittent wiper operation.

"Automatically Move Seat Back on Exit" — If Equipped

This feature provides automatic driver seat positioning to enhance driver mobility when entering and exiting the vehicle. To make your selection, press and release the FUNCTION SELECT button until "ON" or "OFF" appears.

NOTE: The seat will return to the memorized seat location (if Recall Memory with Remote Key Unlock is set to ON) when the remote keyless entry transmitter is used to unlock the door. Refer to "Easy Entry/Exit Seat" under "Driver Memory Seat" in Section 3 of this manual for more information.

"Flash Lights with Remote Key Lock"

When ON is selected, the front and rear turn signals will flash when the doors are locked or unlocked with the remote keyless entry transmitter. This feature may be selected with or without the sound horn on lock feature

selected. To make your selection, press and release the FUNCTION SELECT button until "ON" or "OFF" appears.

"Headlights On with Wipers"

When ON is selected, and the headlight switch is in the AUTO position, the headlights will turn on approximately 10 seconds after the wipers are turned on. The headlights will also turn off when the wipers are turned off if they were turned on by this feature. To make your selection, press and release the FUNCTION SELECT button until "ON" or "OFF" appears.

NOTE: Turning the headlights on during the daytime causes the instrument panel lights to dim. To increase the brightness, refer to "Lights" in Section 3 of this manual.

"Delay Turning Headlights Off"

When this feature is selected, the driver can choose to have the headlights remain on for 0, 30, 60, or 90 seconds when exiting the vehicle. To make your selection, press and release the FUNCTION SELECT button until "0," "30," "60," or "90" appears.

“Tilt Mirrors Down in Reverse”

When ON is selected, the outside rearview mirrors will tilt downward when the ignition switch is in the ON position and the transmission is in the R (Reverse) position. The mirrors will move back to their previous position when the transmission is shifted out of R (Reverse). To make your selection, press and release the FUNCTION SELECT button until “ON” or “OFF” appears.

“Turn Headlights On with Remote Key Unlock”

When this feature is selected, the headlights will activate and remain on for up to 90 seconds when the doors are unlocked with the remote keyless entry transmitter. To make your selection, press and release the FUNCTION SELECT button until “OFF,” “30 sec.,” “60 sec.,” or “90 sec.” appears.

“Delay Power Off to Accessories Until Exit”

When this feature is selected, the power window switches, radio, hands-free system (if equipped), DVD video system (if equipped), power sunroof (if equipped), and power outlets will remain active for up to 60 minutes after the ignition switch is turned off. Opening a vehicle

door will cancel this feature. To make your selection, press and release the FUNCTION SELECT button until “Off,” “45 sec.,” “5 min.,” “10 min.,” “30 min.,” or “60 min.” appears.

“Confirmation of Voice Commands” — If Equipped

When ON is selected, all voice commands from the UConnect™ system are confirmed. To make your selection, press and release the FUNCTION SELECT button until “ON” or “OFF” appears.

“Park Assist System”

When ON is selected, the system will scan for objects behind the vehicle when the transmission is in the R (Reverse) or N (Neutral) position. To make your selection, press and release the FUNCTION SELECT button until “ON” or “OFF” appears.

“Turn by Turn Navigation” — If Equipped

When ON is selected, the Turn-by-Turn directions will appear in the display as the vehicle approaches a designated turn within a programmed route. To make your selection, press and release the FUNCTION SELECT button until “ON” or “OFF” appears.

“Display Units of Measure in”

The EVIC, odometer, and navigation system (if equipped) can be changed between English and Metric units of measure. To make your selection, press and release the FUNCTION SELECT button until “US” or “METRIC” appears.

“Automatic High Beams” — If Equipped

When this feature is selected, the high beam headlights will deactivate automatically under certain conditions. To make your selection, press and release the FUNCTION SELECT button until “ON” or “OFF” appears. Refer to “SmartBeams” in section 3 of this manual for more information.

SETTING THE ANALOG CLOCK

To set the analog clock at the top center of the instrument panel, press and hold the button until the setting is correct.

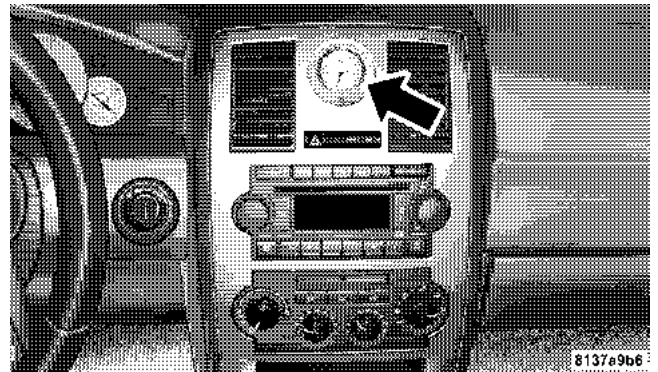

Analog Clock

RADIO GENERAL INFORMATION

Radio Broadcast Signals

Your new radio will provide excellent reception under most operating conditions. Like any system, however, car radios have performance limitations, due to mobile operation and natural phenomena, which might lead you to believe your sound system is malfunctioning. To help you understand and save you concern about these “apparent” malfunctions, you must understand a point or two about the transmission and reception of radio signals.

Two Types of Signals

There are two basic types of radio signals... AM or Amplitude Modulation, in which the transmitted sound causes the amplitude, or height, of the radio waves to vary... and FM or Frequency Modulation, in which the frequency of the wave is varied to carry the sound.

Electrical Disturbances

Radio waves may pick up electrical disturbances during transmission. They mainly affect the wave amplitude,

and thus remain a part of the AM reception. They interfere very little with the frequency variations that carry the FM signal.

AM Reception

AM sound is based on wave amplitude, so AM reception can be disrupted by such things as lightning, power lines and neon signs.

FM Reception

Because FM transmission is based on frequency variations, interference that consists of amplitude variations can be filtered out, leaving the reception relatively clear, which is the major feature of FM radio.

NOTE: The radio, steering wheel radio controls, and 6 disc CD/DVD changer (if equipped) will remain active for up to 60 minutes after the ignition switch is turned off. Opening either front door will cancel this feature. The time is programmable. For details, refer to “Delay Power Off to Accessories Until Exit,” under “Personal Settings (Customer Programmable Features),” under “Electronic Vehicle Information Center (EVIC)” in Section 4 of this manual.

SALES CODE RAK – AM/FM/CASSETTE/CD (6-DISC) RADIO WITH OPTIONAL SATELLITE RADIO, HANDS FREE PHONE, VIDEO, MP3, and WMA CAPABILITIES

NOTE: The radio sales code is located on the lower right side of your radio faceplate.

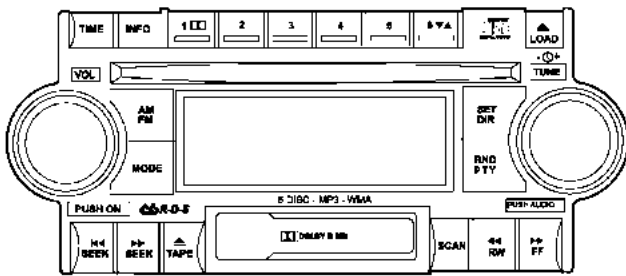

RAK Radio

Operating Instructions - Radio Mode

NOTE: The ignition switch must be in the ON or ACC position to operate the radio.

Power Switch/Volume Control (Rotary)

Press the ON/VOL control to turn the radio ON. Press the ON/VOL a second time to turn OFF the radio.

Electronic Volume Control

The electronic volume control turns continuously (360 degrees) in either direction without stopping. Turning the volume control to the right increases the volume and to the left decreases it.

When the audio system is turned on, the sound will be set at the same volume level as last played.

Mode Button (Radio Mode)

Press the mode button repeatedly to select between the CD player, Cassette, Satellite, or Vehicle Entertainment System (VES) (if equipped).

SEEK Button (Radio Mode)

Press and release the SEEK button to search for the next station in either AM/FM or Satellite (if equipped) mode.

Press the right side of the button to seek up and the left side to seek down. The radio will remain tuned to the new station until you make another selection. Holding the button will bypass stations without stopping until you release it.

SCAN Button (Radio Mode)

Pressing the SCAN button causes the tuner to search for the next station, in either AM, FM or Satellite (if equipped) frequencies, pausing for 5 seconds (satellite scan 8 seconds) at each listenable station before continuing to the next. To stop the search, press SCAN a second time.

Time Button

Press the time button and the time of day will display for 5 seconds.

Clock Setting Procedure

1. Press and hold the time button until the hours blink.
2. Adjust the hours by turning the right side Tune/Audio control.

3. After the hours are adjusted, press the right side Tune/Audio control to set the minutes. The minutes will begin to blink.

4. Adjust the minutes using the right side Tune/Audio control.

5. To exit, press any button/knob or wait 5 seconds.

INFO Button (Radio Mode)

Press the INFO button for an RBDS station (one with call letters displayed). The radio will return a Radio Text message broadcast (if available) from an FM station (FM mode only).

RW/FF (Radio Mode)

Pressing the rewind/fast forward button causes the tuner to search for the next frequency in the direction of the arrows. This feature operates in either AM, FM or Satellite (if equipped) frequencies.

TUNE Control (Radio Mode)

Turn the right side rotary control to increase or decrease the frequency.

AM/FM Button (Radio Mode)

Press the button to select AM or FM Modes.

Setting the Tone, Balance, and Fade

Press the rotary TUNE control and BASS will display. Turn the TUNE control to the right or left to increase or decrease the Bass tones.

Press the rotary TUNE control a second time and MID will display. Turn the TUNE control to the right or left to increase or decrease the Mid Range tones.

Press the rotary TUNE control a third time and TREBLE will display. Turn the TUNE control to the right or left to increase or decrease the Treble tones.

Press the rotary TUNE control a fourth time and BAL will display. Turn the TUNE control to the right or left to adjust the sound level from the right or left side speakers.

Press the rotary TUNE control a fifth time and FADE will display. Turn the TUNE control to the right or left to adjust the sound level between the front and rear speakers.

Press the rotary TUNE control again to exit setting tone, balance, and fade.

RND/PTY Button (Radio Mode)

Pressing this button once will turn on the PTY mode for 5 seconds. If no action is taken during the 5-second time out, the PTY icon will turn off. Turning the tune knob within 5 seconds will allow the program format type to be selected. Many radio stations do not currently broadcast PTY information.

Turn the tune knob to select the following format types:

| Program Type | 16 Digit-Character Display |
|------------------------------|----------------------------|
| No program type or undefined | None |
| News | News |
| Information | Information |
| Sports | Sports |
| Talk | Talk |
| Rock | Rock |
| Classic Rock | Classic_Rock |
| Adult Hits | Adult_Hits |

| | |
|-----------------------|------------------|
| Soft Rock | Soft_Rock |
| Top 40 | Top_40 |
| Country | Country |
| Oldies | Oldies |
| Soft | Soft |
| Nostalgia | Nostalgia |
| Jazz | Jazz |
| Classical | Classical |
| Rhythm and Blues | Rhythm_and_Blues |
| Soft Rhythm and Blues | Soft_R_&_B |
| Foreign Language | Foreign_Language |
| Religious Music | Religious_Music |
| Religious Talk | Religious_Talk |
| Personality | Personality |
| Public | Public |
| College | College |
| Unassigned | |
| Weather | Weather |

By pressing the SEEK button when the PTY icon is displayed, the radio will be tuned to the next frequency

station with the same selected PTY name. The PTY function only operates when in the FM mode.

If a preset button is activated while in the PTY (Program Type) mode, the PTY mode will be exited and the radio will tune to the preset station.

NOTE: If you have selected a PTY with the tune knob, simply pressing the tune button in will go directly to a "PTY seek".

Buttons 1 - 6 (Radio Mode)

These buttons tune the Radio to the stations that you commit to push-button memory {12 AM, 12 FM, and 12 Satellite (if equipped) stations}.

Operating Instructions — Tape Player

Insert the cassette with the exposed tape side toward the left and the mechanical action of the player will gently pull the cassette into the play position.

NOTE: When subjected to extremely cold temperatures, the tape mechanism may require a few minutes to warm up for proper operation. Sometimes poor playback may be experienced due to a defective cassette tape. Clean and demagnetize the tape heads at least twice a year.

Seek Button

Press the SEEK button up for the next selection on the tape and down to return to the beginning of the current selection.

Press the SEEK button up or down to move the track number to skip forward or backward 1 to 6 selections. Press the SEEK button once to move 1 selection, twice to move 2 selections, etc.

Fast Forward (FF)

Press the FF button up momentarily to advance the tape in the direction that it is playing. The tape will advance until the button is pressed again or the end of the tape is reached. At the end of the tape, the tape will play in the opposite direction.

Rewind (RW)

Press the RW button momentarily to reverse the tape direction. The tape will reverse until the button is pressed again or until the end of the tape is reached. At the end of the tape, the tape will play in the opposite direction.

Tape Eject

Press this button and the cassette will disengage and eject from the radio.

Scan Button

Press this button to play 10 seconds of each selection. Press the scan button a second time to cancel the feature.

4

Changing Tape Direction

If you wish to change the direction of tape travel (side being played), press Preset 6. The lighted arrow in the display window will show the new direction.

Metal Tape Selection

If a standard metal tape is inserted into the player, the player will automatically select the correct equalization.

Pinch Roller Release

If ignition power or the radio ON/OFF switch is turned off, the pinch roller will automatically retract to protect the tape from any damage. When power is restored to the tape player, the pinch roller will automatically reengage and the tape will resume play.

Noise Reduction

The Dolby Noise Reduction System* is on whenever the tape player is on, but may be switched off.

To turn off the Dolby Noise reduction System: Press Preset 1 after you insert the tape. The NR light in the display will go off when the Dolby System is off.

* "Dolby" noise reduction is manufactured under license from Dolby Laboratories Licensing Corporation. Dolby and the double-D symbol are trademarks of Dolby Laboratories Licensing Corporation.

Operation Instructions - (CD MODE for CD Audio Play)

NOTE: The ignition switch must be in the ON or ACC position to operate the radio.

NOTE: Note: This Radio is capable of playing compact discs (CD), recordable compact discs (CD-R), rewritable compact discs (CD-RW) compact discs with MP3 tracks and multisession compact discs with CD and MP3 tracks and WMA.

Inserting Compact Disc(s)**CAUTION!**

This CD player will accept 4 3/4 inch (12 cm) discs only. The use of other sized discs may damage the CD player mechanism.

You may eject a disc with the radio OFF.

If you insert a disc with the ignition ON and the radio ON, the unit will switch from radio to CD mode and begin to play when you insert the disc. The display will show the disc number, the track number, and index time in minutes and seconds. Play will begin at the start of track 1.

SEEK Button (CD MODE for CD Audio Play)

Press the right side of the SEEK button for the next selection on the CD. Press the left side of the button to return to the beginning of the current selection, or return to the beginning of the previous selection if the CD is within the first 5 seconds of the current selection.

SCAN Button (CD MODE for CD Audio Play)

Press the Scan button to scan through each track on the CD currently playing.

LOAD/EJECT Button (CD Mode for CD Audio Play)**LOAD/EJECT - Load**

Press the LOAD/EJT button and the push-button with the corresponding number where the CD is being loaded. The radio will display PLEASE WAIT and prompt when to INSERT DISC. After the radio displays "INSERT DISC," insert the CD into the player.

Radio display will show "LOADING DISC" when the disc is loading and "READING DISC" when the radio is reading the disc.

LOAD/EJT - Eject

Press the LOAD/EJT button and the push-button with the corresponding number where the CD was loaded and the disc will unload and move to the entrance for easy removal.

Radio display will show "EJECTING DISC" when the disc is being ejected and prompt the user to remove the disc.

Press and hold the LOAD/EJT button for 5 seconds and all CDs will be ejected from the radio.

If you have ejected a disc and have not removed it within 15 seconds, it will be reloaded. If the CD is not removed, the radio will continue to play the non-removed CD. If the CD is removed and there are other CD's in the radio, the radio will play the next CD after a 2-minute timeout. If the CD is removed and there are no other CD's in the radio, the radio will remain in CD mode and display "INSERT DISC" for 2 minutes. After 2 minutes, the radio will go to the previous tuner mode.

The disc can be ejected with the radio and ignition OFF.

TIME Button (CD MODE for CD Audio Play)

Press this button to change the display from a large CD playing time display to a small CD playing time display.

RW/FF (CD MODE for CD Audio Play)

Press and hold FF (Fast Forward) and the CD player will begin to fast forward until FF is released or RW or another CD button is pressed. The RW (Reverse) button works in a similar manner.

TUNE Control (CD MODE for CD Audio Play)

Pressing the TUNE control allows the setting of the Tone, Fade, and Balance. See Radio Mode.

AM/FM Button (CD MODE for CD Audio Play)

Switches the Radio to the Radio mode.

RND/PTY Button (Random Play Button) (CD MODE for CD Audio Play)

Press this button while the CD is playing to activate Random Play. This feature plays the selections on the compact disc in random order to provide an interesting change of pace.

NOTE: MP3 and WMA Random Play are for file folders only.

Press the SEEK button to move to the next randomly selected track.

Press and hold the FF button to fast forward through the tracks. Release the FF button to stop the fast forward feature. If the RW button is pressed, the current track will reverse to the beginning of the track and begin playing.

Press the RND button a second time to stop Random Play.

Buttons 1 - 6 (CD MODE for CD Audio Play)

Selects disc positions 1 - 6 for Play/Load/Eject.

Notes On Playing MP3 Files

The radio can play MP3 files; however, acceptable MP3 file recording media and formats are limited. When writing MP3 files, pay attention to the following restrictions.

Supported Media (Disc Types)

The MP3 file recording media supported by the radio are CD-ROM, CD-R, and CD-RW.

Supported Medium Formats (File Systems)

The medium formats supported by the radio are ISO 9660 Level 1 and Level 2 and includes the Joliet extension. When reading discs recorded using formats other than ISO 9660 Level 1 and Level 2, the radio may fail to read

files properly and may be unable to play the file normally. UDF and Apple HFS formats are not supported.

The radio uses the following limits for file systems:

- Maximum number of directory levels: 15
- Maximum number of files: 255
- Maximum number of folders: 100
- Maximum number of characters in file/folder names:
 - Level 1: 12 (including a separator "." and a 3-character extension)
 - Level 2: 31 (including a separator "." and a 3-character extension)

Multisession disc formats are supported by the radio. Multisession discs may contain combinations of normal CD audio tracks and computer files (including MP3 files). Discs created with an option such as "keep disc open after writing" are most likely multisession discs. The use of multisession for CD audio or MP3 playback may result in longer disc loading times.

Supported MP3 File Formats

The radio will recognize only files with the *.mp3 extension as MP3 files. Non-MP3 files named with the *.mp3 extension may cause playback problems. The radio is designed to recognize the file as an invalid MP3 and will not play the file.

When using the MP3 encoder to compress audio data to an MP3 file, the bit rate and sampling frequencies in the following table are supported. In addition, variable bit rates (VBR) are also supported. The majority of MP3 files use a 44.1 kHz sampling rate and a 192, 160, 128, 96 or VBR bit rates.

| MPEG Specification | Sampling Frequency (kHz) | Bit rate (kbps) |
|----------------------|--------------------------|---|
| MPEG-1 Audio Layer 3 | 48, 44.1, 32 | 320, 256, 224, 192, 160, 128, 112, 96, 80, 64, 56, 48, 40, 32 |
| MPEG-2 Audio Layer 3 | 24, 22.05, 16 | 160, 128, 144, 112, 96, 80, 64, 56, 48, 40, 32, 24, 16, 8 |

ID3 Tag information for artist, song title, and album title are supported for version 1 ID3 tags. ID3 version 2 is not supported by the radios.

Playlist files are not supported. MP3 Pro files are not supported.

Playback of MP3 and WMA Files

When a medium containing MP3 data is loaded, the radio checks all files on the medium. If the medium contains a lot of folders or files, the radio will take more time to start playing the MP3 files.

Loading times for playback of MP3 and WMA files may be affected by the following:

- Media - CD-RW media may take longer to load than CD-R media
- Medium formats - Multisession discs may take longer to load than non-multisession discs
- Number of files and folders - Loading times will increase with more files and folders

To increase the speed of disc loading, it is recommended to use CD-R media and single-session discs. To create a single-session disc, enable the Disc at Once option before writing to the disc.

Operation Instructions - (CD Mode for MP3 and WMA Audio Play)

SEEK Button (CD Mode for MP3 and WMA Play)

Pressing the right side of the SEEK button plays the next file. Pressing the left side of the SEEK button plays the beginning of the file. Pressing the button within the first ten seconds plays the previous file.

LOAD/EJECT Button (CD Mode for MP3 and WMA Play)

LOAD/EJT - Load



LOAD

Press the LOAD/EJT button and the push-button with the corresponding number where the CD is being loaded. The radio will display PLEASE WAIT and prompt when to INSERT DISC. After the radio displays "INSERT DISC," insert the CD into the player.

The radio display will show "LOADING DISC" when the disc is loading.

LOAD/EJT - Eject



Press the LOAD/EJT button and the push-button with the corresponding number where the CD was loaded and the disc will unload and move to the entrance for easy removal.

Radio display will show "EJECTING DISC" when the disc is being ejected and prompt the user to remove the disc.

If you have ejected a disc and have not removed it within 15 seconds, it will be reloaded. If the CD is not removed, the radio will continue to play the non-removed CD. If the CD is removed and there are other CD's in the radio, the radio will play the next CD after a 2-minute timeout. If the CD is removed and there are no other CD's in the radio, the radio will remain in CD mode and display "INSERT DISC" for 2 minutes. After 2 minutes, the radio will go to the previous tuner mode.

INFO Button (CD Mode for MP3 Play)

Press and INFO button while playing MP3 or WMA disc. The radio scrolls through the following TAG information: Song Title, Artist, File Name, and Folder Name (if available).

Press the INFO button once more to return to "elapsed time" priority mode.

Press and hold the INFO button while in the message display priority mode or elapsed time display priority mode will display the song title for each file.

RW/FF (CD Mode for MP3 and WMA Play)

Press the FF side of the button to move forward through the file or MP3 and WMA selection.

TUNE Control (CD Mode for MP3 Play)

Pressing the TUNE Control allows the adjustment of Tone, Balance, and Fade.

AM/FM Button (CD Mode for MP3 Play)

Switches back to Radio mode.

RND/PTY Button (CD Mode for MP3 Play)

Pressing this button plays files randomly.

SET/DIR Button (CD Mode for MP3 Play)

Press the SET/DIR Button to display folders, when playing an MP3 discs that have a file/folder structure. Turn the TUNE control to display available folders or move through available folders. Press the TUNE control to select a folder.

Buttons 1 - 6 (CD Mode for MP3 Play)

Selects disc positions 1 - 6 for Play/Load/Eject.

Operating Instructions - Hands Free Phone (If Equipped)

Refer to "Hands-Free Phone" in Section 3 of the Owner's Manual.

Operating Instructions - Satellite Radio Mode (If Equipped)

Refer to the "Satellite Radio" section of the Owner's Manual.

Operating Instructions - Video Entertainment System (VES) (If Equipped)

Refer to separate "Video Entertainment System (VES) Guide."

SALES CODE REC — AM/FM/CD (6-DISC) RADIO WITH NAVIGATION SYSTEM

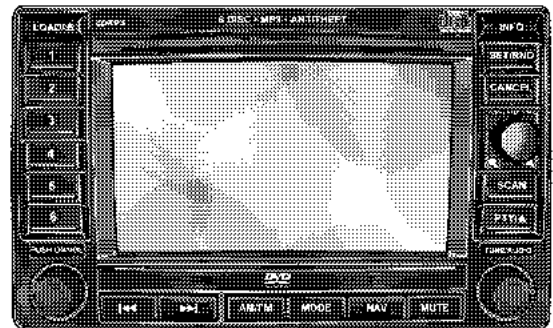

8125e256

REC Radio

Satellite Navigation Radio with CD Player with MP3 Capability (REC) - combines a Global-Positioning System-based navigation system with an integrated color

screen to provide maps, turn identification, selection menus and instructions for selecting a variety of destinations and routes, AM/FM stereo radio and six-disc CD changer with MP3 capability.

Mapping information for navigation is supplied on a DVD that is loaded into the unit. One map DVD covers all of North America. Refer to your "Navigation User's Manual" for detailed operating instructions.

Operating Instructions — Satellite Radio (If Equipped)

Refer to your "Navigation User's Manual" for detailed operating instructions.

REC Setting the Clock

GPS Clock

The GPS receiver used in this system is synchronized to the time data being transmitted by the GPS satellites. The satellites' clock is Greenwich Mean Time (GMT). This is the worldwide standard for time. This makes the system's clock very accurate once the appropriate time zone and daylight savings information is set.

1. At the **Main Menu** screen, highlight "Clock Setup" and press ENTER OR press and hold for 3 seconds the TIME button on the unit's faceplate. The **Clock Setup** screen appears.

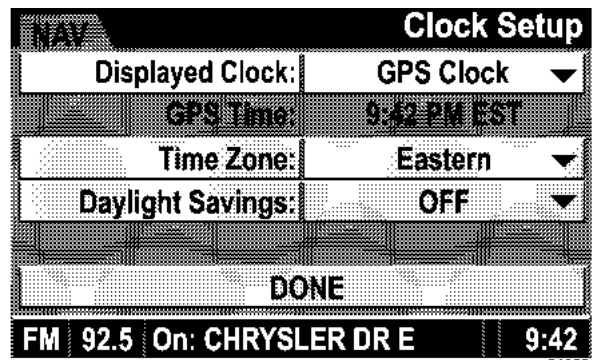

2. To show the GPS clock, select "Displayed Clock: GPS Clock" and press ENTER.
3. To adjust the time zone, Select "Time Zone" and press ENTER. Select the appropriate time zone and press ENTER.

4. To turn daylight savings on or off, select “Daylight Savings” and press ENTER. Select “On” or “Off” and press ENTER.

5. Select DONE to exit from the clock setting mode. Press ENTER to save your changes. If you press CANCEL or NAV then your changes will not be saved.

User Defined Clock

If you wish to set the clock to a time different than the system clock, you can manually adjust the time by choosing the “User Defined Clock” option.

1. At the **Clock Setup** screen highlight “Displayed Clock: User Defined Clock”.

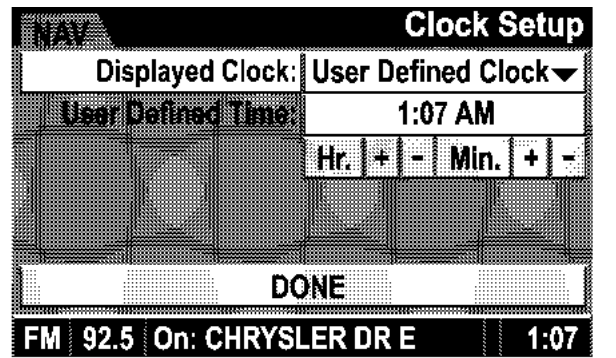

2. To increase the clock by hours, make sure “HR +” is highlighted and press ENTER. Press ENTER again to increase the clock by another hour. You will see on the “User Defined Time” display the number of hours you have increased the clock by.

3. To decrease the clock by one hour, use the Select Encoder to highlight the “-” sign. Press ENTER. Press ENTER again to decrease the clock by another hour.

4. To increase the clock by minutes, make sure "MIN +" is highlighted and press ENTER. Press ENTER again to increase the clock by another minute.
5. To decrease the clock by minutes, use the Select Encoder to highlight the "--" sign. Press ENTER. Press ENTER again to decrease the clock by another minute.
6. Select "DONE" to exit from the clock setting mode. Press ENTER to save your changes. If you press CANCEL or NAV then your changes will not be saved.

Audio Clock Display

Select this option to change the size of the clock on the audio screens.

1. When you are at an audio screen, quickly press the TIME button on the navigation faceplate.
2. In this example the large clock appears on the screen.

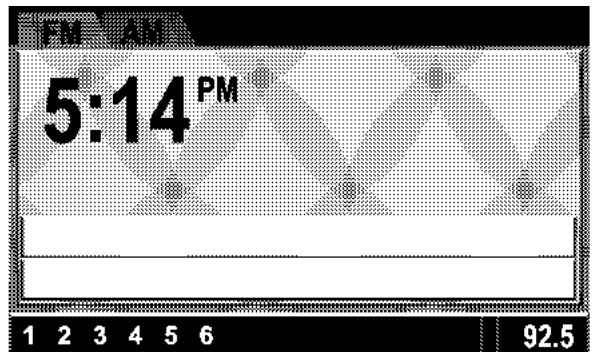

819a09a5

3. To switch the clock to the small clock, quickly press TIME again.

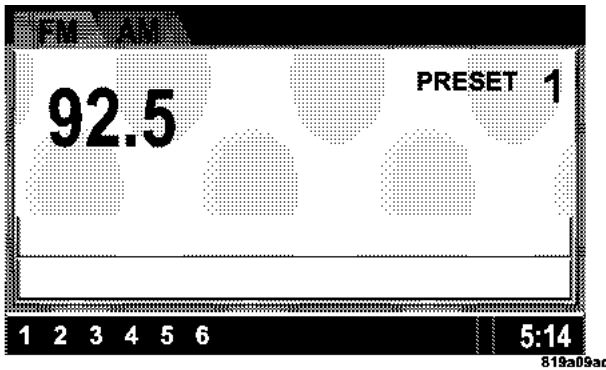

4. To toggle back to the large clock, simply press TIME.

VIDEO ENTERTAINMENT SYSTEM (SALES CODE XRV) — IF EQUIPPED

The optional VES™ (Video Entertainment System) consists of a DVD player and LCD (liquid crystal display) screen, a battery-powered remote control, and two headsets. The system is located in the center console storage bin under the armrest lid. Refer to your VES™ User's Manual for detailed operating instructions.

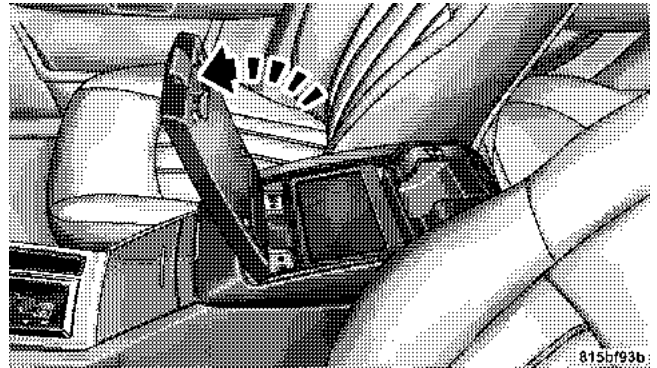

Accessing The VES

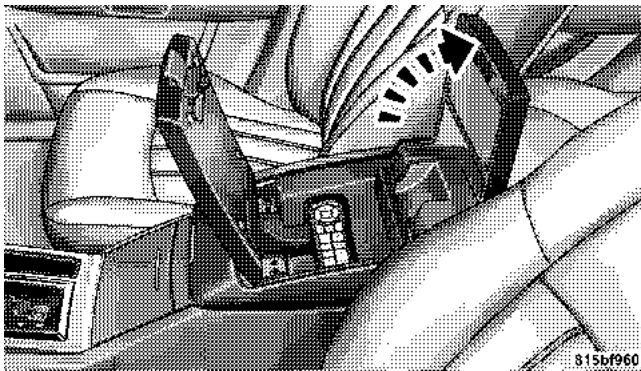

Raising The DVD Screen

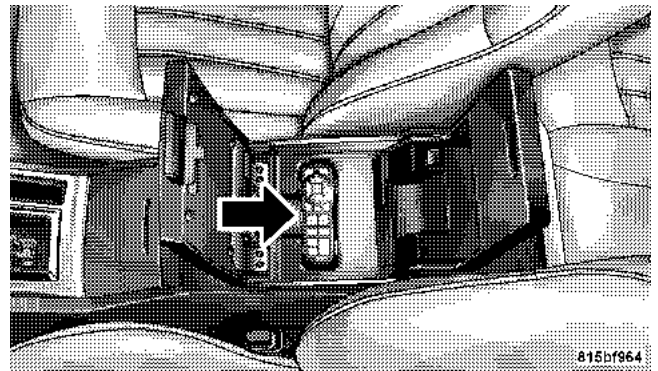

Remote Control Location

Kicker Mobile Surround (KMS1)

The VES for this vehicle comes equipped with Kicker Mobile Surround (KMS1). This feature offers the ultimate movie experience by providing surround sound uniquely equalized for the interior space of your vehicle.

The KMS1 activates whenever a DVD is in the VES player, and the radio mode is set to VES, and the video screen is powered up. The system will go back to stereo sound automatically if the VES is powered down, or the

video screen is stowed away, or the radio is set to a mode other than VES, or if you are using the Aux jacks on the VES.

Your vehicle is equipped with a state of the art digital audio amplifier that decodes stereo sound inputs into 5.1 formatted surround sound. When in surround sound mode, the KMS1 automatically sets balance and fade to provide the optimal surround experience.

SATELLITE RADIO — IF EQUIPPED

Satellite radio uses direct satellite to receiver broadcasting technology to provide clear digital sound, coast to coast. The subscription service provider is Sirius™ Satellite Radio. This service offers over 100 channels of music, sports, news, entertainment, and programming for children, directly from its satellites and broadcasting studios.

System Activation

NOTE: Your vehicle's radio must be on and in satellite mode when the activation process takes place.

To activate your Sirius Satellite Radio service, call the toll-free number 888-539-7474, or visit the Sirius web site

at www.sirius.com. Please have the following information available when activating your system:

1. The Electronic Serial Number/Sirius Identification Number (ESN/SID).
2. Credit card information.
3. Your Vehicle Identification Number.

Electronic Serial Number/Sirius Identification Number (ESN/SID)

The Electronic Serial Number/Sirius Identification Number is needed to activate your Sirius Satellite Radio system. To access the ESN/SID, refer to the following steps:

ESN/SID Access With REF Radios

With the ignition switch in the ACCESSORY position and the radio OFF, press the CD Eject and Time buttons simultaneously for 3 seconds. The first four digits of the twelve-digit ESN/SID number will display. Press the SEEK UP button to display the next four digits. Continue to press the SEEK UP button until all twelve ESN/SID digits display. The SEEK DOWN will page down until the first four digits display. The radio will exit the

ESN/SID mode when any other button is pushed, the ignition is turned OFF, or 5 minutes has passed since any button was pushed.

ESN/SID Access With RAQ and RAK Radios

With the ignition switch in the ACCESSORY position and the radio OFF, press the CD Eject and TIME buttons simultaneously for 3 seconds. All twelve ESN/SID numbers will display. The radio will exit the ESN/SID mode when any other button is pushed, the ignition is turned OFF, or 5 minutes has passed since any button was pushed.

ESN/SID Access With REC Navigation Radios

Please refer to your Navigation User's Manual.

With the ignition in the ACCESSORY position and the radio off, press the CD Eject and Set buttons simultaneously until the 12 digits of the ESN/SID appear on the screen.

Selecting Satellite Mode in REF, RAQ, and RAK Radios

Selecting Satellite Mode — REF Radio

Press the MODE button repeatedly until the word "SAT" appears in the display.

A CD may remain in the radio while in the Satellite radio mode.

Selecting Satellite Mode — RAQ and RAK Radio

Press the MODE button repeatedly until the word "SAT" appears in the display.

These radios will also display the current station name and program type. For more information, such as song title and artist press the MSG or INFO button.

A CD or tape may remain in the radio while in the Satellite radio mode.

Selecting a Channel

Press and release the SEEK or TUNE knob to search for the next channel. Press the top of the button to search up

and the bottom of the button to search down. Holding the TUNE button causes the radio to bypass channels until the button is released.

Press and release the SCAN button (if equipped) to automatically change channels every 7 seconds. The radio will pause on each channel for 7 seconds before moving on to the next channel. The word "SCAN" will appear in the display between each channel change. Press the SCAN button a second time to stop the search.

NOTE: Channels that may contain objectionable content can be blocked. Contact Sirius Customer Care at 888-539-7474 to discuss options for channel blocking or unblocking. Please have your ESN/SID information available.

Storing and Selecting Pre-Set Channels

In addition to the 12 AM and 12 FM pre-set stations, you may also commit 12 satellite stations to push button memory. These satellite channel pre-set stations will not erase any AM or FM pre-set memory stations. Follow the memory pre-set procedures that apply to your radio.

Using the PTY (Program Type) Button (if equipped)

Follow the PTY button instructions that apply to your radio.

PTY Button "SCAN"

When the desired program type is obtained, press the "SCAN" button within five seconds. The radio will play 7 seconds of the selected channel before moving to the next channel of the selected program type. Press the "SCAN" button a second time to stop the search.

NOTE: Pressing the "SEEK" or "SCAN" button, while performing a music type scan, will change the channel by one and stop the search. Pressing a pre-set memory button during a music type scan, will call up the memory channel and stop the search.

PTY Button "SEEK"

When the desired program is obtained, press the "SEEK" button within five seconds. The channel will change to the next channel that matches the program type selected.

Satellite Antenna

To ensure optimum reception, do not place items on the roof around the rooftop antenna location. Metal objects placed within the line of sight of the antenna will cause decreased performance. Larger luggage items should be placed as far forward as possible. Do not place items directly on or above the antenna.

Reception Quality

Satellite reception may be interrupted due to one of the following reasons.

- The vehicle is parked in an underground parking structure or under a physical obstacle.
- Dense tree coverage may interrupt reception in the form of short audio mutes.
- Driving under wide bridges or along tall buildings can cause intermittent reception.
- Placing objects over or too close to the antenna can cause signal blockage.

REMOTE SOUND SYSTEM CONTROLS

The remote sound system controls are located on the surface of the steering wheel at the 3 and 9 o'clock positions.

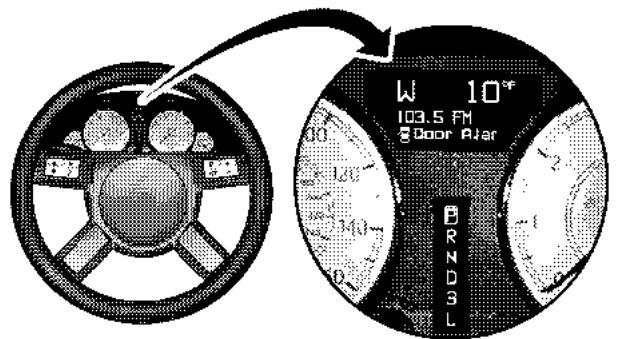

818c9c36

Electronic Vehicle Information Center

Vehicles equipped with steering wheel mounted buttons are also equipped with the Electronic Vehicle Information Center (EVIC). The EVIC features a driver-interactive display. This is located in the upper part of the instrument cluster between the speedometer and tachometer.

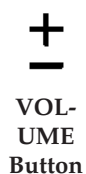

The VOLUME button controls the sound level of the sound system. Press the top of the VOLUME button to increase the sound level. Press the bottom of the VOLUME button to decrease the sound level.



Press the AUDIO MODE button to select the Compass/Temp/Audio screen. This screen displays radio station frequencies, any one of twelve radio station preset frequencies, CD disc number, CD track number, tape, or any one of 200 Satellite radio channels depending on which radio is in the vehicle.

If Compass/Temp/Audio is already displayed when the AUDIO MODE button is pressed, then the radio mode will change from AM to FM, to Tape, to CD, or to Satellite (SAT) accordingly.



When the EVIC is in the Compass/Temp/Audio screen, press the FUNCTION SELECT button to advance the radio to the next preset station, to change the side of the tape being played (if so equipped), or to change the current CD track being played (if so equipped).



when the EVIC is in the Compass/Temp/Audio screen, press the SCROLL button to seek up and down the radio stations, CD track numbers (if so equipped), or satellite radio channels (if so equipped).

The following describes the operation of the SCROLL button in each mode:

Radio Operation

Press the top of the SCROLL button once to SEEK the next listenable station up from the current setting. Press the bottom of the SCROLL button once to SEEK the next listenable station down from the current setting.

Tape Player Operation

Press the top of the SCROLL button once to listen to the next track on the cassette. Press the bottom of the SCROLL button once either to listen to the beginning of the current track or to listen to the beginning of the previous track if it is within 5 seconds after the current track begins to play.

Press either the top or bottom of the SCROLL button twice to listen to the second track on the tape, three times to listen to the third track, and so forth.

Press the FUNCTION SELECT button to change the side of the tape being played.

CD Player Operation

Press the top of the SCROLL button once to listen to the next track on the CD. Press the bottom of the SCROLL button once either to listen to the beginning of the current track or to listen to the beginning of the previous track if it is within one second after the current track begins to play.

Press either the top or bottom of the SCROLL button twice to listen to the second track on the CD, three times to listen to the third track, and so forth.

Satellite Radio Operation

Press the top of the SCROLL button once to SEEK the next listenable station up from the current setting. Press the bottom of the SCROLL button once to SEEK the next listenable station down from the current setting.

CASSETTE TAPE AND PLAYER MAINTENANCE

To keep the cassette tapes and player in good condition, take the following precautions:

1. Do not use cassette tapes longer than C-90; otherwise, sound quality and tape durability will be greatly diminished.
2. Keep the cassette tape in its case to protect from slackness and dust when it is not in use.
3. Keep the cassette tape away from direct sunlight, heat, and magnetic fields such as the radio speakers.
4. Before inserting a tape, make sure that the label is adhering flatly to the cassette.

5. A loose tape should be corrected before use. To rewind a loose tape, insert the eraser end of a pencil into the tape drive gear and twist the pencil in the required directions.

Maintain your cassette tape player. The head and capstan shaft in the cassette player can pick up dirt or tape deposits each time a cassette is played. The result of deposits on the capstan shaft may cause the tape to wrap around and become lodged in the tape transport. The other adverse condition is low or "muddy" sound from one or both channels, as if the treble tone control were turned all the way down. To prevent this, you should periodically clean the head with a commercially available WET cleaning cassette.

As preventive maintenance, clean the head about every 30 hours of use. If you wait until the head becomes very dirty (noticeably poor sound), it may not be possible to remove all deposits with a simple WET cleaning cassette.

CD/DVD DISC MAINTENANCE

To keep the CD/DVD discs in good condition, take the following precautions:

1. Handle the disc by its edge; avoid touching the surface.
2. If the disc is stained, clean the surface with a soft cloth, wiping from center to edge.
3. Do not apply paper, paper CD labels, or tape to the disc; avoid scratching the disc.
4. Do not use solvents such as benzine, thinner, cleaners, or antistatic sprays.
5. Store the disc in its case after playing.
6. Do not expose the disc to direct sunlight.
7. Do not store the disc where temperatures may become too high.

RADIO OPERATION AND CELLULAR PHONES

Under certain conditions, the cellular phone being On in your vehicle can cause erratic or noisy performance from your radio. This condition may be lessened or eliminated by relocating the cellular phone antenna. This condition is not harmful to the radio. If your radio performance does not satisfactorily “clear” by the repositioning of the antenna, it is recommended that the radio volume be turned down or off during cellular phone operation.

CLIMATE CONTROLS

The Air Conditioning and Heating System is designed to make you comfortable in all types of weather.

Automatic Temperature Control

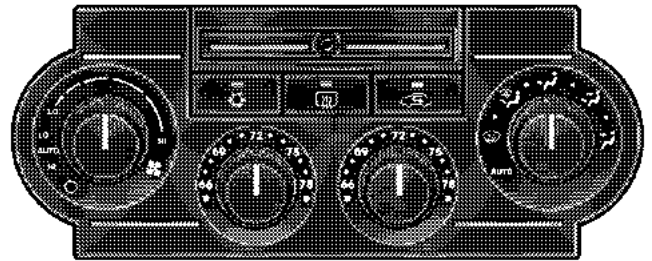

4

8135020a

Automatic Temperature Controls

Automatic Operation

The Infrared Dual-Zone Climate Control System automatically maintains the climate in the cabin of the vehicle at the comfort levels desired by the driver and passenger. To accomplish this, the system gathers information from the controls on the climate control, from a dual sun-sensor located in the top of the instrument panel, from an infrared sensor located in the face of the climate control, and from various sensors located throughout the vehicle.

The controls on the climate control provide the system with operator input. The dual sun-sensor monitors sun load coming through the windshield. The infrared sensor independently measures the surface temperature of the driver and passenger. Other sensors take account of vehicle-speed, A/C pressure, outside temperature, and engine cooling temperature. Using all of these inputs, the system automatically adjusts airflow temperature, airflow distribution, airflow volume, and the amount of outside air recirculation. This maintains a comfortable temperature even under changing conditions.

Operation of the system is quite simple. Begin by turning the Mode Control knob (on the right) to AUTO, and place the Blower Control knob (on the left) to either LO AUTO or HI AUTO. The LO AUTO position should be used for front seat occupants only. The HI AUTO position should be used when more airflow is desired, or when rear seat occupants are present. Then, dial in the temperature you would like the system to maintain by rotating the driver or passenger Temperature Control knob. Once the comfort level is selected, the system will maintain that level

automatically using the heating system. Should the desired comfort level require air conditioning, the system will automatically make the adjustment.

You will experience the greatest efficiency by simply allowing the system to function automatically. Selecting the OFF position on the fan control stops the system completely and closes the outside air intake.

72°F (22°C) is the recommended setting for maximum comfort for the average person; however, this may vary.

NOTE: The temperature setting can be adjusted at any time without affecting automatic operation.



Air conditioning in this system is automatic. Pressing the Air Conditioning Control button while in AUTO mode will cause the LED in the control button to flash three times and then turn off. This indicates that the system is in AUTO mode and requesting the air conditioning is not necessary.



The system will automatically control recirculation. However, pressing the Recirculation Control button will temporarily put the system in recirculation mode (ten minutes).

This can be used when outside conditions such as smoke, odors, dust, or high humidity are present. Activating recirculation will cause the LED in the control button to illuminate. After ten minutes, the system will return to normal AUTO mode function and the LED will turn off.

NOTE:

- The surface of the climate control panel and the top center of the instrument panel should be kept free of debris due to the location of the climate control sensors. Mud on the windshield may also cause poor operation of this system.
- Extended use of recirculation may cause the windows to fog. If the interior of the windows begins to fog, press the Recirculation button to return to outside air.

Some temp/humidity conditions will cause captured interior air to condense on windows and hamper visibility. For this reason, the system will not allow Recirculation to be selected while in defrost or defrost/floor mode. Attempting to use the recirculation while in these modes will cause the LED in the control button to blink and then turn off.

Manual Operation

This system offers a full complement of manual override features, which consist of Blower Preferred Automatic, Mode Preferred Automatic, or Blower and Mode Preferred Automatic. This means the operator can override the blower, the mode, or both. There is a manual blower range for times when the AUTO setting is not desired. The blower can be set to any fixed blower speed by rotating the Blower Control knob (on the left).

NOTE: Please read the Automatic Temperature Control Operation Chart that follows for details.

| Automatic Temperature Control Operation | | The system will... | | | | |
|---|--|-------------------------------|--|-------------------------|---|--------------------------------|
| | | Blower Control | Mode Control | Air Temperature Control | Air Recirculation Control | A/C Operation |
| Full Automatic Operation | Set blower knob to either Hi or Lo Auto. Set mode knob to Auto. Set temperature knobs for comfort. | Automatic | Automatic | Automatic | Automatic but can be overridden for 10 minutes at a time. | Automatic |
| Blower Preferred Automatic | Set blower knob to any desired airflow level other than Hi or Lo Auto. Set mode knob to Auto. Set temperature knobs for comfort. | User selectable to any speed. | Automatic | Automatic | Automatic but can be overridden for 10 minutes at a time. | Automatic |
| Mode Preferred Automatic | Set mode knob to any desired air delivery point other than Auto. Set blower knob to either Hi or Lo Auto. Set temperature knobs for comfort. | Automatic | User selectable to any air delivery point. | Automatic | User selectable outside or recirculated. | User selectable A/C on or off. |
| Blower and Mode Preferred Automatic | Set blower knob to any desired airflow level other than Hi or Lo Auto. Set mode knob to any desired air delivery point other than Auto. Set temperature knobs for comfort. | User selectable to any speed. | User selectable to any air delivery point. | Automatic | User selectable outside or recirculated. | User selectable A/C on or off. |

The operator can override the AUTO mode setting to change airflow distribution by rotating the Mode Control knob (on the right) to one of the following positions.

- *Defrost*



Air is directed to the windshield through the outlets at the base of the windshield. Air is also directed to the front door windows through the side window demister grilles.

- *Defrost/Floor*



Air flows through the front and rear floor outlets and the outlets at the base of the windshield. Air is also directed to the front door windows through the side window demister grilles.

- *Floor*



Air flows through the floor outlets located under the instrument panel and into the rear seating area through vents under the front seats.

- *Bi-Level*



Air flows through the outlets located in the instrument panel and through the outlets located on the floor. Air flows through the registers in the back of the center console to the rear seat passengers. These registers can be closed to block airflow.

- *Panel*



Air flows through the outlets located in the instrument panel. Air flows through the registers in the back of the center console to the rear seat passengers. These registers can be closed to block airflow.

- *Air Conditioning Control*



Press this button to turn on the air conditioning during manual operation only. When the air conditioning is turned on, cool dehumidified air will flow through the outlets selected with the Mode control dial. Press this button a second time to turn off the air conditioning. An LED in the button illuminates when manual compressor operation is selected.

NOTE: To control the air conditioning manually, the mode selector must be moved out of the AUTO position.

- **Recirculation Control**



This button can be used to block out smoke, odors, dust, high humidity, or if rapid cooling is desired. The recirculation mode should only be used temporarily. An LED in the button illuminates when the recirculation mode is active. You may use this feature separately.

NOTE: Extended use of recirculation may cause the windows to fog. If the interior of the windows begins to fog, press the Recirculation button to return to outside air. Some temp/humidity conditions will cause captured interior air to condense on windows and hamper visibility. For this reason, the system will not allow Recirculation to be selected while in defrost or defrost/floor mode. Attempting to use the recirculation while in these modes will cause the LED in the control button to blink and then turn off.

Operating Tips

NOTE: Refer to the chart at the end of this section for suggested control settings for various weather conditions.

Summer Operation

The engine cooling system in air-conditioned vehicles must be protected with a high-quality antifreeze coolant to provide proper corrosion protection and to protect against engine overheating. A 50% solution of ethylene glycol antifreeze coolant in water is recommended. Refer to "Maintenance Procedures" in Section 7 of this manual for proper coolant selection.

Winter Operation

Use of the air Recirculation mode during winter months is not recommended because it may cause window fogging.

Vacation Storage

Anytime you store your vehicle, or keep it out of service (i.e. vacation) for two weeks or more, run the air conditioning system at idle for about five minutes in the fresh air and high blower setting. This will insure adequate

system lubrication to minimize the possibility of compressor damage when the system is started again.

Window Fogging

Interior fogging on the windshield can be quickly removed by turning the mode selector to Defrost. The Defrost/Floor mode can be used to maintain a clear windshield and provide sufficient heating. If side window fogging becomes a problem increase blower speed. Vehicle windows tend to fog on the inside in mild but rainy or humid weather.

NOTE: Recirculate without A/C should not be used for long periods as fogging may occur.











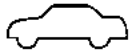





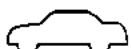

Outside Air Intake

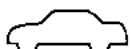
Make sure the air intake, located directly in front of the windshield, is free of obstructions such as leaves. Leaves collected in the air intake may reduce airflow, and if they enter the plenum, they could plug the water drains. In winter months, make sure the air intake is clear of ice, slush, and snow.

A/C Air Filter — If Equipped

The climate control system filters outside air containing dust, pollen and some odors. Strong odors cannot be totally filtered out. Refer to "Maintenance Procedures" in Section 7 of this manual for filter replacement instructions.

Control Setting Suggestions for Various Weather Conditions

| WEATHER | CONTROL SETTINGS |
|--|--|
| <p>HOT WEATHER AND VEHICLE INTERIOR IS VERY HOT</p>   | <p>Open the windows, start the vehicle, set the Mode control to Panel  or Bi-Level , and turn on A/C. Set the Fan control to the High position (full clockwise). Set the temperature control to full cool. After the hot air is flushed from the vehicle, set the Mode control to Recirculate  with A/C on and roll up the windows. Once you are comfortable, set the Mode control to Panel  or Bi-Level  with A/C on.</p> |
| <p>WARM WEATHER</p>   | <p>If it's sunny, set the Mode control to Panel  and turn on A/C. If it's cloudy or dark, set the Mode control to Bi-Level  with A/C on. Adjust Temperature control for comfort.</p> |
| <p>COOL OR COLD HUMID CONDITIONS</p>   | <p>Set the Mode control to Defrost/Floor  or Defrost . Set the Fan Control to the High position (full clockwise). Adjust Fan and Temperature control for comfort if windows are clear.</p> |
| <p>COLD DRY CONDITIONS</p>   | <p>Set the Mode control to Floor . If it's sunny, you may want more upper air. In this case, set the Mode control to Bi-Level . In very cold weather, if you need extra heat at the windshield, set the Mode control to Defrost/Floor  or Defrost  as needed. Adjust Fan and Temperature control for comfort.</p> |

REAR WINDOW FEATURES

Electric Rear Window Defroster

 The electric Rear Window Defroster Control is located on the climate control. Press this button to turn on the rear window defroster and the heated side mirrors (if equipped). An LED in the button will illuminate when the rear window defroster is ON. The defroster automatically turns off after approximately 10 minutes of operation for the first push of the button, and will turn off after approximately 5 minutes for the second push of the button.

CAUTION!

To avoid damaging the electrical conductors of the rear window defroster, do not use scrapers, sharp instruments, or abrasive window cleaners on the interior surface of the window.

Labels can be peeled off after soaking with warm water.

STARTING AND OPERATING

CONTENTS

| | | | |
|--|-----|--|-----|
| ■ Starting Procedures | 196 | □ 5 Speed Automatic Transmission | 203 |
| □ Automatic Transmission | 197 | ■ AutoStick® | 207 |
| □ Normal Starting | 197 | □ AutoStick® Operation | 207 |
| □ Extremely Cold Weather (Below -20°F Or -29°C) | 197 | □ AutoStick® General Information | 208 |
| □ If Engine Fails To Start | 197 | ■ Driving On Slippery Surfaces | 209 |
| □ After Starting | 198 | □ Acceleration | 209 |
| ■ Engine Block Heater — If Equipped | 199 | □ Traction | 209 |
| ■ Automatic Transmission | 199 | ■ Parking Brake | 210 |
| □ Automatic Transmission — General Information | 200 | ■ Brake System | 211 |
| □ Brake/Transmission Shift Interlock System | 202 | □ Anti-Lock Brake System | 211 |
| | | ■ Power Steering | 213 |

| | | | |
|--|-----|--|-----|
| ■ Electronic Brake Control System | 214 | □ Tire Spinning | 232 |
| □ ABS (Anti-Lock Brake System) | 214 | □ Tread Wear Indicators | 233 |
| □ TCS (Traction Control System) | 215 | □ Life Of Tire | 233 |
| □ BAS (Brake Assist System) | 215 | □ Replacement Tires | 234 |
| □ ESP (Electronic Stability Program) | 216 | □ Alignment And Balance | 235 |
| □ Synchronizing ESP | 219 | ■ Tire Chains | 235 |
| □ ESP/BAS Malfunction Indicator Light And ESP/TCS Indicator Light | 219 | ■ Snow Tires | 236 |
| ■ Tire Safety Information | 220 | ■ Tire Rotation Recommendations | 237 |
| □ Tire Markings | 220 | □ Tire Rotation — Standard Tires | 238 |
| □ Tire Identification Number (TIN) | 224 | □ Tire Rotation — All Season Tires | 238 |
| □ Tire Loading And Tire Pressure | 225 | ■ Tire Pressure Monitor System (TPMS) — If Equipped | 239 |
| ■ Tires — General Information | 229 | □ Base System — If Equipped | 241 |
| □ Tire Pressure | 229 | □ Premium System — If Equipped | 242 |
| □ Tire Inflation Pressures | 230 | □ General Information | 245 |
| □ Radial-Ply Tires | 232 | ■ Fuel Requirements | 246 |

| | | | |
|---|-----|---|-----|
| □ 6.1L Engine | 246 | □ Vehicle Certification Label | 252 |
| □ Reformulated Gasoline | 246 | □ Gross Vehicle Weight Rating (GVWR) | 252 |
| □ Gasoline/Oxygenate Blends | 247 | □ Gross Axle Weight Rating (GAWR) | 252 |
| □ MMT In Gasoline | 247 | □ Overloading | 253 |
| □ Materials Added To Fuel | 247 | □ Loading | 253 |
| □ Fuel System Cautions | 248 | ■ Trailer Towing | 254 |
| □ Carbon Monoxide Warnings | 248 | ■ Recreational Towing (Behind Motorhome, Etc.) | 254 |
| ■ Adding Fuel | 249 | □ Towing This Vehicle Behind Another Vehicle (Flat Towing With All Four Wheels On The Ground) | 254 |
| □ Fuel Filler Cap (Gas Cap) | 249 | ■ Ground Clearance | 254 |
| □ Loose Fuel Filler Cap Message | 251 | | |
| ■ Vehicle Loading | 252 | | |

STARTING PROCEDURES

Before starting your vehicle, adjust your seat, adjust the inside and outside mirrors, fasten your seat belt, and if present, instruct all other occupants to buckle their seat belts.

WARNING!

- **Never leave children alone in a vehicle. Leaving children in a vehicle unattended is dangerous for a number of reasons. A child or others could be seriously or fatally injured. Don't leave the keys in the ignition. A child could operate power windows, other controls, or move the vehicle.**
- **Do not leave animals or children inside parked vehicles in hot weather; interior heat build up may cause serious injury or death.**
- **Be sure to turn off the engine if you want to rest or sleep in your car. Accidents can be caused by inadvertently moving the gear selection lever or by pressing the accelerator pedal. This may cause excessive heat in the exhaust system, resulting in overheating and vehicle fire, which may cause serious or fatal injuries.**

Automatic Transmission

The gear selector must be in the NEUTRAL or PARK position before you can start the engine. Apply the brakes before shifting into any driving gear.

Normal Starting

Normal Starting of either a cold or a warm engine is obtained without pumping or depressing the accelerator pedal. Turn the key to the "START" position and release when the engine starts. If the engine has not started within 3 seconds, slightly depress the accelerator pedal while continuing to crank. If the engine fails to start within 15 seconds, turn the key to the "LOCK" position, wait 10 to 15 seconds, then repeat the normal starting procedure.

Extremely Cold Weather (below -20°F or -29°C)

To insure reliable starting at these temperatures, use of an externally powered electric engine block heater (available from your dealer) is recommended.

If Engine Fails To Start

If the engine fails to start after you have followed the "NORMAL STARTING" procedure, it may be flooded. Push the accelerator pedal all the way to the floor and hold it there while cranking the engine. This should clear any excess fuel in case the engine is flooded.

CAUTION!

To prevent damage to the starter, do not crank the engine for more than 15 seconds at a time. Wait 10 to 15 seconds before trying again.

WARNING!

- Never pour fuel or other flammable liquid into the throttle body air inlet opening in an attempt to start the vehicle. This could result in flash fire causing serious personal injury.
- Do not attempt to push or tow your vehicle to get it started. Vehicles equipped with an automatic transmission cannot be started this way. Unburned fuel could enter the catalytic converter and once the engine has started, ignite and damage the converter and vehicle. If the vehicle has a discharged battery, booster cables may be used to obtain a start from a booster battery or the battery in another vehicle. This type of start can be dangerous if done improperly. See section 6 of this manual for the proper jump-starting procedures and follow them carefully.

If the engine is flooded, it may start to run, but not have enough power to continue running when the key is released. If this occurs, continue cranking up to 15 seconds with the accelerator pedal pushed all the way to the floor. Release the accelerator pedal and the key once the engine is running smoothly. Do not overspeed the engine.

If the engine shows no sign of starting after two 15-second periods of cranking with the accelerator pedal held to the floor, the "NORMAL STARTING" procedure should be repeated.

After Starting

The idle speed is controlled automatically and it will decrease as the engine warms up.

ENGINE BLOCK HEATER — IF EQUIPPED

The engine block heater warms engine coolant and permits quicker starts in cold weather. Connect the cord to a standard 110-115 volt AC electrical outlet with a grounded, three-wire extension cord.

The engine block heater cord is routed under the hood on the driver side of the vehicle. It has a removable cap that is located on the driver side of the Integrated Power Module.

WARNING!

Remember to disconnect the cord before driving. Damage to the 110-115 volt electrical cord could cause electrocution.

AUTOMATIC TRANSMISSION**CAUTION!**

Damage to the transmission may occur if the following precautions are not observed:

- **Shift into PARK only after the vehicle has come to a complete stop.**
- **Shift into or out of REVERSE only after the vehicle has come to a complete stop and the engine is at idle speed.**
- **Do not shift from REVERSE, PARK, or NEUTRAL into any forward gear when the engine is above idle speed.**
- **Before shifting into any gear, make sure your foot is firmly on the brake pedal.**

WARNING!

It is dangerous to shift the selector lever out of “P” or “N” if the engine speed is higher than idle speed. If your foot is not firmly on the brake pedal, the vehicle could accelerate quickly forward or in reverse. You could lose control of the vehicle and hit someone or something. Only shift into gear when the engine is idling normally and when your right foot is firmly on the brake pedal.

Automatic Transmission — General Information

The automatic transmission selects individual gears automatically, dependent upon:

- Altitude
- Vehicle Loading
- Driving Style
- Selector lever position
- Accelerator position
- Vehicle speed

The gear shifting process is continuously adapted, dependent on the driving style, the driving situation and the road characteristics.

NOTE:

- After selecting any driving position, wait a moment to allow the gear to engage fully before accelerating, especially when the engine is cold.
- If there is a need to restart the engine, be sure to cycle the key to the LOCK position before restarting. Transmission engagement may be delayed up to 10 seconds after restart if the key is not cycled to the LOCK position first.
- The electronically controlled transmission provides a precise shift schedule. The transmission electronics are self-calibrating. Therefore, the first few shifts on a new vehicle may be somewhat abrupt or soft until after the break-in period. This is a normal condition, and precision shifts will develop within a few shift cycles.

The selector lever is automatically locked while in the P (Park) position. To move the selector lever out of the P (Park) position, the brake pedal must be firmly depressed before the shift lock will release.

Shift the selector lever to the desired position only when the engine is idling normally and the brake pedal is applied. Do not release the brake until ready to drive. The vehicle may otherwise accelerate quickly when the selector lever is in D (Drive) or R (Reverse) position.

WARNING!

Unintended movement of a vehicle could injure those in and near the vehicle. As with all vehicles, you should never exit a vehicle while the engine is running. Before exiting a vehicle, you should always shift the vehicle into P (Park), remove the key from the ignition, and apply the parking brake. Once the key is removed from the ignition, the transmission selector lever is locked in the P (Park) position, securing the vehicle against unwanted movement. Furthermore, you should never leave children unattended inside a vehicle.

Over Temperature Mode

The transmission electronics constantly monitor the transmission oil temperature. If the transmission exceeds normal operating temperature, the transmission will change the way it shifts to help control the condition. This may result in a slightly different feeling or response during normal operation in D (Drive) position. After the transmission cools down, it will return to normal operation.

Brake/Transmission Shift Interlock System

This vehicle is equipped with a brake transmission shift interlock system (BTSI) that holds the selector lever in the P (Park) position when the ignition switch is in the LOCK position. To move the gear selector lever out of the P (Park) position, the ignition switch must be turned to the ON position, and the brake pedal must be depressed.

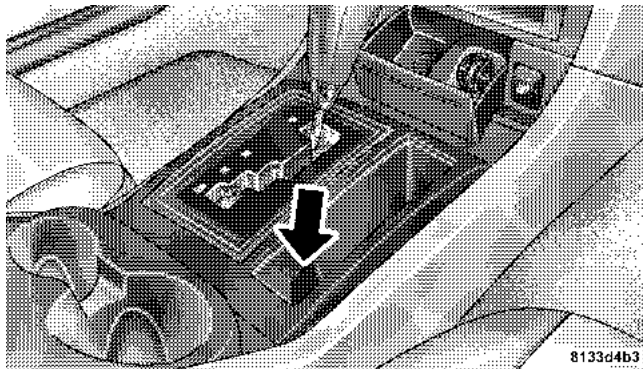

Brake Interlock Override

For electrical system malfunctions, there is an override for the interlock system. In order to override this system the key must be in the ignition with the switch in the ACC or ON positions. Remove the rubber storage tray from the bin located to the right of the shifter lever. The override can be activated by pressing the pink-colored tab, which can be accessed through a hole inside the bin. While the override is pressed, the shifter can be moved out of the park position without pressing the brake. After operation, return the rubber storage tray to its original position.

5 Speed Automatic Transmission

Shifting from D (Drive) to P (Park) or R (Reverse) (or from P or R to D) should be done only after the accelerator pedal is released and the vehicle is stopped. Be sure to keep your foot on the brake when moving the selector lever between these gears.

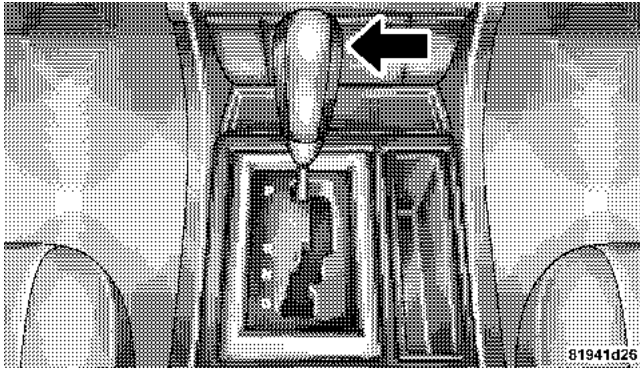

Selector Lever

Gear Ranges

P (Park)

P (Park) supplements the parking brake by locking the transmission. The engine can be started in this range.

Never use P (Park) while the vehicle is in motion. Apply the parking brake when leaving the vehicle in this range.

When parking on a flat surface, place the gear selector in the P (Park) position first, and then apply the parking brake.

When parking on a hill, it is important to set the parking brake before placing the gear selector in P (Park), otherwise the load on the transmission locking mechanism may make it difficult to move the selector out of park. As an added precaution, turn the front wheels toward the curb on a downhill grade and away from the curb on an uphill grade.

WARNING!

Never use Park position on an automatic transmission as a substitute for the parking brake. Always apply parking brake fully when parked to guard against vehicle movement and possible injury or damage.

The following indicators should be used to ensure that you have engaged the selector lever into the P (Park) position:

- When shifting into P (Park) move the lever all the way forward until it stops, and is fully seated.
- Look at the shift indicator display on the instrument panel to ensure it is in the P (Park) position.

CAUTION!

Damage to the shifter could result if the selector lever is moved out of P (Park) before the ignition is turned from the LOCK to ON position.

R (Reverse)

Shift into R (Reverse) gear only when the vehicle is completely stopped.

N (Neutral)

No power is transmitted from the engine to the drive axle. When the brakes are released, the vehicle can be moved freely (pushed or towed). Do not engage N

(Neutral) position while driving except to coast when the vehicle is in danger of skidding (e.g., on icy roads).

The engine may be started in this range. Use this range for starting your vehicle if it is moving or being towed.

CAUTION!

Coasting the vehicle, or driving for any other reason with selector lever in NEUTRAL can result in transmission damage.

WARNING!

Do not coast in N (Neutral) and never turn off the ignition to coast down a hill. These are unsafe practices that limit your response to changing traffic or road conditions. You might lose control of the vehicle and have an accident.

D (Drive)

This range should be used for most city and highway driving. It provides the smoothest upshifts and downshifts and best fuel economy.

The transmission automatically upshifts through fifth gear. The D (Drive) position provides optimum driving characteristics under all normal operating conditions.

When frequent transmission shifting occurs when using the Overdrive range, such as when operating the vehicle under heavy loading conditions (in hilly terrain, traveling into strong head winds, or while towing heavy trailers, use the AutoStick® mode and select the “3” range.

AutoStick® Gear selection

The AutoStick® feature can be selected by pressing the selector lever to the right or the left with the lever in the D (Drive) position. The gear currently selected is indicated in the instrument cluster display. Briefly, press the selector lever in the “D -” direction and the transmission will shift from the current gear to the next lower gear.

Press and hold the selector lever in the “D -” direction and the transmission will shift from the current gear directly to the next lowest gear for best acceleration.

NOTE: To avoid overrevving the engine when the selector lever is moved in “D -” direction, the transmission will not shift to a lower gear if the engine’s revolutions per minute (RPM) limit would be exceeded.

Briefly, press the selector lever in the “D +” direction and the transmission will shift from the current gear to the next higher gear.

Press and hold the selector lever in the “D +” direction and the transmission will shift from the current gear directly to gear “D.”

WARNING!

On slippery road surfaces, never downshift in order to obtain braking action. This could result in drive wheel slip and reduced vehicle control. Your vehicle's ABS will not prevent this type of loss of control. You could lose control of your vehicle and have an accident.

Delayed Shifts in Cold Temperatures

During cold temperature operation, you may notice delayed upshifts depending on engine and transmission temperature as well as vehicle speed. This feature improves warm up time of the engine and transmission to achieve maximum efficiency.

Temporary Transmission Limp Home Mode

The transmission is monitored for abnormal conditions. If a condition is detected that could result in transmission damage, the transmission will engage Limp Home Mode. If vehicle acceleration worsens, or the transmission no longer shifts, the transmission is most likely operating in the Limp Home Mode. In this mode, the transmission

will remain in the current gear until the vehicle is brought to a stop. After the vehicle has stopped, P (Park), R (Reverse), and N (Neutral) will continue to operate. Second gear will operate in the D (Drive) shifter position. The Malfunction Indicator Light may be illuminated.

A reset feature is available to allow the vehicle to be driven to a dealer for service. To reset the transmission, use the following procedure:

1. Stop the vehicle.
2. Move the selector lever to the P (Park) position.
3. Turn off the engine.
4. Wait approximately 10 seconds.
5. Restart the engine.
6. Move the selector lever to the desired range. If the problem is no longer detected, the transmission will return to normal operation.

NOTE: Even if the transmission can be reset, we recommend that you visit a dealer at your earliest possible convenience. Your dealer has diagnostic equipment to determine if the problem could recur.

Have the transmission checked at your authorized dealer as soon as possible.

If the problem has been momentary, the transmission can be reset to regain all forward gears.

Permanent Transmission Limp Home Mode

Permanent Limp Home Mode will be activated if the transmission enters temporary Limp Home Mode three times. Follow the reset procedure described under “Temporary Transmission Limp Home Mode” in this section. In Permanent Limp Home Mode, P (Park), R (Reverse), and N (Neutral) will continue to operate. Second gear will operate in the D (Drive) shifter position. The malfunction indicator light may illuminate.

AUTOSTICK®

Autostick® is a driver-interactive transmission that offers manual gear shifting to provide you with more control of the vehicle. Autostick® allows you to maximize engine braking, eliminate undesirable upshifts and downshifts, and improve overall vehicle performance. This system can also provide you with more control during passing, city driving, cold slippery conditions, mountain driving, trailer towing, and many other situations.

Autostick® Operation

By placing the selector lever in the D (Drive) position, it can be moved from side to side. This allows the driver to select a higher or lower range of gears. Moving the selector lever to the Left (-) triggers a downshift and to the Right (+) an upshift. The gear position will display in the instrument cluster on the transmission range indicator.

NOTE:

- In Autostick® mode, the transmission will only shift up and down when the driver manually moves the selector lever Right (D+) or Left (D-).

- An UPSHIFT message will appear in the Electronic Vehicle Information Center (EVIC) portion of the instrument cluster when using Autostick®. This message appears in order to alert the driver to upshift to the next gear. The UPSHIFT message will display while operating the vehicle at higher engine revolutions-per-minute (RPM).

You can shift in or out of the Autostick® mode at any time without taking your foot off the accelerator pedal. When you wish to engage Autostick®, simply move the selector lever to the Right (D+) or Left (D-) while in the D (Drive) position. The transmission will remain in the current gear until an upshift or downshift is chosen. When you wish to disengage Autostick®, hold the selector lever to the right for at least one second. The transmission will now operate automatically, shifting between the five available gears.

Autostick® General Information

- You can start out in first or second gear. The system will ignore attempts to upshift at too low of a vehicle speed.
- The transmission will automatically downshift to first gear when coming to a stop.
- Starting out in second gear is helpful in snowy or icy conditions.
- Avoid using speed control when Autostick® is engaged.
- The transmission will not automatically shift up when maximum engine speed is reached while Autostick® is engaged.
- Transmission shifting will be more noticeable when Autostick® is engaged.

DRIVING ON SLIPPERY SURFACES

Acceleration

Rapid acceleration on snow covered, wet, or other slippery surfaces may cause the rear wheels to pull erratically to the right or left. This phenomenon occurs when there is a difference in the surface traction under the rear (driving) wheels.

WARNING!

Rapid acceleration on slippery surfaces is dangerous. Unequal traction can cause sudden pulling of the rear wheels. You could lose control of the vehicle and possibly have an accident. Accelerate slowly and carefully whenever there is likely to be poor traction (ice, snow, wet mud, loose sand, etc.).

Traction

When driving on wet or slushy roads, it is possible for a wedge of water to build up between the tire and road surface. This is known as hydroplaning and may cause partial or complete loss of vehicle control and stopping ability. To reduce this possibility, the following precautions should be observed:

1. Slow down during rainstorms or when the roads are slushy.
2. Slow down if road has standing water or puddles.
3. Replace tires when tread wear indicators first become visible.
4. Keep tires properly inflated.
5. Maintain sufficient distance between your vehicle and the vehicle in front to avoid a collision in a sudden stop.

PARKING BRAKE

The parking brake should always be applied when the driver is not in the vehicle.

WARNING!

Never use Park position on an automatic transmission as a substitute for the parking brake. Always apply parking brake fully when parked to guard against vehicle movement and possible injury or damage.

When parking on a flat surface, place the gear selector in the P (Park) position first, and then apply the parking brake.

When parking on a hill, it is important to apply the parking brake before placing the gear selector in P (Park), otherwise the load on the transmission locking mechanism may make it difficult to move the selector out of park. As an added precaution, turn the front wheels toward the curb on a downhill grade and away from the curb on an uphill grade.

The foot operated parking brake is positioned below the lower left corner of the instrument panel. To apply the parking brake, push the parking brake pedal down and then remove your foot from the pedal. To release the parking brake, push down on the parking brake pedal and then release.

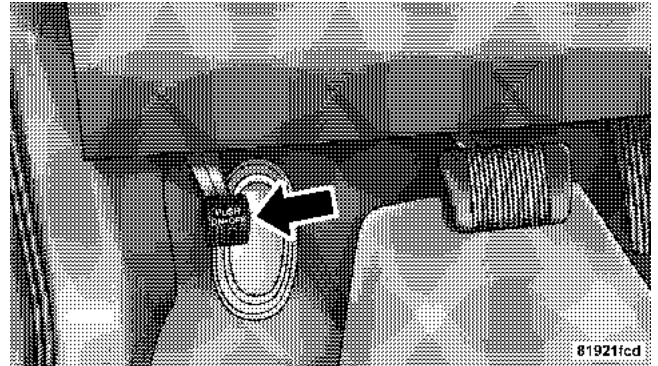

Parking Brake

The brake light in the instrument cluster will turn on when the parking brake is applied and the ignition switch is on.

NOTE: This light only shows that the parking brake is applied. It does not show the degree of brake application.

WARNING!

- **Never leave children alone in a vehicle. Leaving children in a vehicle unattended is dangerous for a number of reasons. A child or others could be seriously or fatally injured. Don't leave the keys in the ignition. A child could operate power windows, other controls, or move the vehicle.**
- **Be sure the parking brake is fully disengaged before driving: failure to do so can lead to brake failure, and an accident.**

BRAKE SYSTEM

BRAKE Your vehicle is equipped with dual hydraulic brake systems. If either of the two hydraulic systems loses normal capability, the remaining system will still function. There will be some loss of overall braking effectiveness. This may be evident by increased pedal travel during application, greater pedal force required to slow or stop, and potential activation of the Brake Warning Light.

In the event power assist is lost for any reason (for example, repeated brake applications with the engine off) the brakes will still function. The effort required to brake the vehicle will be much greater than that required with the power system operating.

Anti-Lock Brake System

The Anti-Lock Brake System provides increased vehicle stability and brake performance under most braking conditions. The system automatically "pumps" the brakes during severe braking conditions to prevent wheel lock-up.

The electronic brake force distribution (EBD) prevents the rear wheels from over-braking and provides greater control of available braking forces applied to the rear axle.

When the vehicle is driven over 7 mph (11 km/h), you may also hear a slight clicking sound as well as some related motor noises. These noises are the system performing its self check cycle to ensure that the ABS system is working properly. This self check occurs each time the vehicle is started and accelerated past 7 mph (11 km/h).

ABS is activated during braking under certain road or stopping conditions. ABS-inducing conditions can include ice, snow, gravel, bumps, railroad tracks, loose debris, or panic stops.

You also may experience the following when the brake system goes into Anti-lock:

- The ABS motor running (it may continue to run for a short time after the stop),
- the clicking sound of solenoid valves,
- brake pedal pulsations,
- and a slight drop or fall away of the brake pedal at the end of the stop.

These are all normal characteristics of ABS.

WARNING!

- The Anti-Lock Brake System contains sophisticated electronic equipment that may be susceptible to interference caused by improperly installed or high output radio transmitting equipment. This interference can cause possible loss of anti-lock braking capability. Installation of such equipment should be performed by qualified professionals.
- Pumping of the Anti-Lock Brakes will diminish their effectiveness and may lead to an accident. Pumping makes the stopping distance longer. Just press firmly on your brake pedal when you need to slow down or stop.
- Anti-lock system (ABS) cannot prevent the natural laws of physics from acting on the vehicle, nor can it increase braking or steering efficiency beyond that afforded by the condition of the vehicle brakes and tires or the traction afforded.
- The ABS cannot prevent accidents, including those resulting from excessive speed in turns, following another vehicle too closely, or hydroplaning. Only a safe, attentive, and skillful driver can prevent accidents.
- The capabilities of an ABS equipped vehicle must never be exploited in a reckless or dangerous manner, which could jeopardize the user's safety or the safety of others.

All vehicle wheels and tires must be the same size and type and tires must be properly inflated to produce accurate signals for the computer.

Anti-Lock Brake Light

 The ABS light monitors the Anti-Lock Brake System. The light will come on when the ignition switch is turned to the ON position and may stay on for as long as four seconds.

If the ABS light remains on or comes on while driving, it indicates that the Anti-Lock portion of the brake system is not functioning and that service is required. However, the conventional brake system will continue to operate normally if the BRAKE warning light is not on.

If the ABS light is on, the brake system should be serviced as soon as possible to restore the benefits of Anti-Lock brakes. If the ABS light does not come on when the Ignition switch is turned to the ON position, have the bulb repaired as soon as possible.

If both the Brake Warning Light and the ABS Light remain on, the Anti-Lock brakes (ABS) and Electronic

Brake Force Distribution (EBD) systems are not functioning. Immediate repair to the ABS system is required.

POWER STEERING

The standard power steering system will give you good vehicle response and increased ease of maneuverability in tight spaces. The system will provide mechanical steering capability if power assist is lost.

If for some reason the power assist is interrupted, it will still be possible to steer your vehicle. Under these conditions, you will observe a substantial increase in steering effort, especially at very low vehicle speeds and during parking maneuvers.

NOTE: Increased noise levels at the end of the steering wheel travel are considered normal and do not indicate that there is a problem with the power steering system.

Upon initial start-up in cold weather, the power steering pump may make noise for a short amount of time. This is due to the cold, thick fluid in the steering system. This noise should be considered normal, and does not in any way damage the steering system.

WARNING!

Continued operation with reduced power steering assist could pose a safety risk to yourself and others. Service should be obtained as soon as possible.

CAUTION!

Prolonged operation of the steering system at the end of the steering wheel travel will increase the steering fluid temperature and it should be avoided when possible. Damage to the power steering pump may occur.

ELECTRONIC BRAKE CONTROL SYSTEM

Your vehicle is equipped with an advanced electronic brake control system commonly referred to as ESP. This system includes the ABS (Anti-Lock Brake System), the TCS (Traction Control System), the BAS (Brake Assist System), and the ESP (Electronic Stability Program). These systems work together to enhance both vehicle stability and control in various driving conditions.

ABS (Anti-Lock Brake System)

This system aids the driver in maintaining vehicle control under adverse braking conditions by controlling hydraulic brake pressure. This prevents wheel lock-up to help avoid skidding on slippery surfaces during braking. For more information about ABS, refer to "Anti-Lock Brake System" in Section 5 of this manual.

WARNING!

The ABS (Anti-Lock Brake System) cannot prevent the natural laws of physics from acting on the vehicle, nor can it increase the traction afforded by prevailing road conditions. The ABS cannot prevent accidents, including those resulting from excessive speed in turns, driving on very slippery surfaces, or hydroplaning. Only a safe, attentive, and skillful driver can prevent accidents. The capabilities of an ABS-equipped vehicle must never be exploited in a reckless or dangerous manner, which could jeopardize the user's safety or the safety of others.

TCS (Traction Control System)

This system monitors the amount of wheel spin of each driven wheel. If wheel spin is detected, brake pressure is applied to the slipping wheel(s) and engine power is reduced to provide enhanced acceleration and stability.

BAS (Brake Assist System)

This system complements the Anti-Lock Brake System (ABS) by optimizing the vehicle braking capability during emergency braking maneuvers. This system detects an emergency braking situation by sensing the rate and amount of brake application and then applies optimum pressure to the brakes. This can help reduce braking distances.

Applying the brakes very quickly results in the best BAS assistance. To receive the benefits of this system, you must apply continuous brake pedal pressure during the stopping sequence. Do not reduce brake pedal pressure unless braking is no longer desired. Once the brake pedal is released, the BAS is deactivated.

WARNING!

The BAS (Brake Assist System) cannot prevent the natural laws of physics from acting on the vehicle, nor can it increase the traction afforded by prevailing road conditions. The BAS cannot prevent accidents, including those resulting from excessive speed in turns, driving on very slippery surfaces, or hydroplaning. Only a safe, attentive, and skillful driver can prevent accidents. The capabilities of a BAS-equipped vehicle must never be exploited in a reckless or dangerous manner, which could jeopardize the user's safety or the safety of others.

ESP (Electronic Stability Program)

This system enhances directional control and stability of the vehicle under various driving conditions. The ESP corrects for oversteering and understeering the vehicle by applying the brake of the appropriate wheel. Engine power may also be reduced to assist in counteracting the condition of oversteer or understeer and help the vehicle maintain the desired path.

The ESP uses sensors in the vehicle to determine the path that the driver intends to steer the vehicle and compares it to the actual path of the vehicle. When the actual path does not match the intended path, the ESP applies the brake of the appropriate wheel to assist in counteracting the condition of oversteer or understeer.

- Oversteer - when the vehicle is turning more than appropriate for the steering wheel position.
- Understeer - when the vehicle is turning less than appropriate for the steering wheel position.



The "ESP/TCS Indicator Light," located in the instrument cluster, starts to flash as soon as the tires lose traction and the ESP system becomes active. The "ESP/TCS Indicator Light" also flashes when TCS is active. If the "ESP/TCS Indicator Light" begins to flash during acceleration, ease up on the accelerator and apply as little throttle as possible. Be sure to adapt your speed and driving to the prevailing road conditions.

WARNING!

The ESP (Electronic Stability Program) cannot prevent the natural laws of physics from acting on the vehicle, nor can it increase the traction afforded by prevailing road conditions. The ESP cannot prevent accidents, including those resulting from excessive speed in turns, driving on very slippery surfaces, or hydroplaning. Only a safe, attentive, and skillful driver can prevent accidents. The capabilities of an ESP-equipped vehicle must never be exploited in a reckless or dangerous manner, which could jeopardize the user's safety or the safety of others.

The ESP system has 3 available operating modes:

ESP On

This is the normal operating mode for the ESP. Whenever the vehicle is started, the ESP system will be in this mode. This mode should be used for most all driving situations. The ESP should only be turned off for specific reasons as noted in the following paragraphs.

Partial Off

The "Partial Off" mode is intended for times when a more spirited driving experience is desired. It is also intended for driving in deep snow, sand, or gravel. This mode disables the TCS portion of the ESP and raises the threshold for ESP activation, which allows for more wheel spin than what ESP normally allows.

ESP OFF

The "ESP OFF" button is located in the switch panel above the radio. To enter the "Partial Off" mode, momentarily depress the "ESP OFF" button and the "ESP/TCS Indicator Light" will illuminate. To turn the ESP on again, momentarily depress the "ESP OFF" button and the "ESP/TCS Indicator Light" will turn off.

NOTE: To improve the vehicle's traction when driving with snow chains, or when starting-off in deep snow, sand, or gravel, it may be desirable to switch to the "Partial Off" mode by momentarily depressing the "ESP OFF" button. Once the situation requiring "Partial Off" mode is overcome, turn the ESP on again by momentarily depressing the "ESP OFF" button. This may be done while the vehicle is in motion.

Full Off

This mode is intended for off-highway or off-road use only and should not be used on any public roadways. In this mode, all TCS and ESP stability features are turned off. To enter the "Full Off" mode, depress and hold the "ESP OFF" button for 5 seconds while the vehicle is stopped with the engine running. After 5 seconds, a chime will sound, the "ESP/TCS Indicator Light" will illuminate, and the "ESP OFF" message will display in the vehicle odometer. Press and release the trip odometer button located on the instrument cluster to clear this message. The "ESP OFF" message may appear in the Electronic Vehicle Information Center (EVIC). Refer to "Electronic Vehicle Information Center (EVIC)" in Section 4 of this manual. To turn ESP on again, momentarily depress the "ESP OFF Button."

NOTE: The "ESP OFF," or "ESP System Deactivated" message will display and the audible chime will sound when the gear selector is moved into the PARK position from any position other than PARK and then moved out of the PARK position. This will occur when the message was previously cleared.

WARNING!

In the ESP Full Off mode, the engine torque reduction and stability features are cancelled. Therefore, the enhanced vehicle stability offered by ESP is unavailable.

NOTE: When the ESP is switched off a feature of the system remains active. This feature controls wheel spin across an axle quite similarly to a limited slip differential. If one wheel on an axle is spinning faster than the other, the system will apply the brake of the spinning wheel and allow more engine torque to be applied to the wheel that is not spinning. To improve the vehicle's traction when driving with tire chains, or when starting-off in deep snow, sand, or gravel, it may be desirable to switch to the "Partial Off" mode by momentarily depressing the "ESP OFF" button.

WARNING!

With the ESP switched off, the enhanced vehicle stability offered by ESP is unavailable. In an emergency evasive maneuver, the ESP system will not engage to assist in maintaining stability. The "Full Off" ESP mode is intended for off-highway or off-road only.

Synchronizing ESP**ESP
BAS**

The malfunction indicator light for the ESP is combined with the BAS indicator. If the power supply is interrupted (battery disconnected or discharged), the ESP/BAS malfunction indicator light may illuminate with the engine running. If this should occur, turn the steering wheel completely to the left and then to the right. The ESP/BAS malfunction indicator light should go out. However, if the light remains on, have the ESP and BAS checked at your authorized dealer as soon as possible.

ESP/BAS Malfunction Indicator Light and ESP/TCS Indicator Light**ESP
BAS**

The malfunction indicator light for the ESP is combined with the BAS indicator. The yellow "ESP/BAS Malfunction Indicator Light" and the yellow "ESP/TCS Indicator Light" in the instrument cluster both come on when the ignition switch is turned to the "ON" position. They should go out with the engine running.

The system will turn the "ESP/BAS Malfunction Indicator Light" on continuously while the engine running if it detects a malfunction in either the ESP or the BAS or both. If the light remains on after several ignition cycles, and you have driven the vehicle several miles at speeds greater than 30 mph (48 km/h), and the ESP is synchronized (refer to Synchronizing ESP), see your authorized dealer as soon as possible to have the problem diagnosed and corrected.

NOTE:

- "The "ESP/TCS Indicator Light" and the "ESP/BAS Malfunction Indicator Light" will turn on momentarily each time the ignition switch is turned ON.
- Each time the ignition is turned ON, the ESP System will be ON even if it was turned off previously.
- The ESP Control System will make buzzing or clicking sounds when it is active. This is normal; the sounds will stop when ESP becomes inactive following the maneuver that caused the ESP activation.

TIRE SAFETY INFORMATION

Tire Markings

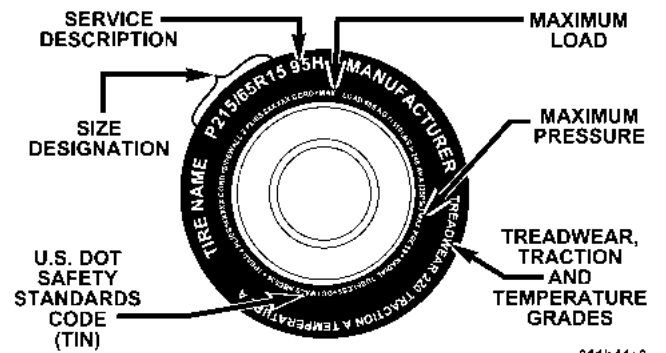

811b44e8

NOTE:

- P (Passenger)-Metric tire sizing is based on U.S. design standards. P-Metric tires have the letter "P" molded into the sidewall preceding the size designation. Example: P215/65R15 95H.
- European Metric tire sizing is based on European design standards. Tires designed to this standard have the tire size molded into the sidewall beginning with the section width. The letter "P" is absent from this tire size designation. Example: 215/65R15 96H
- LT (Light Truck)-Metric tire sizing is based on U.S. design standards. The size designation for LT-Metric tires is the same as for P-Metric tires except for the letters "LT" that are molded into the sidewall preceding the size designation. Example: LT235/85R16.
- Temporary Spare tires are high-pressure compact spares designed for temporary emergency use only. Tires designed to this standard have the letter "T" molded into the sidewall preceding the size designation. Example: T145/80D18 103M.
- High Flotation tire sizing is based on U.S. design standards and it begins with the tire diameter molded into the sidewall. Example: 31x10.5 R15 LT.

Tire Sizing Chart

| EXAMPLE: | |
|--|--|
| Size Designation: | |
| P = Passenger car tire size based on U.S. design standards | |
| "...blank..." = Passenger car tire based on European design standards | |
| LT = Light Truck tire based on U.S. design standards | |
| T = Temporary Spare tire | |
| 31 = Overall Diameter in Inches (in) | |
| 215 = Section Width in Millimeters (mm) | |
| 65 = Aspect Ratio in Percent (%) | —Ratio of section height to section width of tire. |
| 10.5 = Section Width in Inches (in) | |
| R = Construction Code | —"R" means Radial Construction. —"D" means Diagonal or Bias Construction. |
| 15 = Rim Diameter in Inches (in) | |

EXAMPLE:**Service Description:****95** = Load Index

—A numerical code associated with the maximum load a tire can carry.

H = Speed Symbol

—A symbol indicating the range of speeds at which a tire can carry a load corresponding to its load index under certain operating conditions.

—The maximum speed corresponding to the Speed Symbol should only be achieved under specified operating conditions. (i.e. tire pressure, vehicle loading, road conditions, and posted speed limits).

Load Identification:**"...blank..."** = Absence of any text on sidewall of the tire indicates a Standard Load (SL) Tire**Extra Load (XL)** = Extra Load (or Reinforced) Tire**Light Load** = Light Load Tire**C,D,E** = Load range associated with the maximum load a tire can carry at a specified pressure**Maximum Load** — Maximum Load indicates the maximum load this tire is designed to carry.**Maximum Pressure** — Maximum Pressure indicates the maximum permissible cold tire inflation pressure for this tire.

Tire Identification Number (TIN)

The TIN may be found on one or both sides of the tire; however, the date code may only be on one side. Tires with white sidewalls will have the full TIN including date code located on the white sidewall side of the tire.

Look for the TIN on the outboard side of black sidewall tires as mounted on the vehicle. If the TIN is not found on the outboard side then you will find it on the inboard side of the tire.

| EXAMPLE: | |
|----------------------------|---|
| DOT MA L9 ABCD 0301 | |
| DOT | = Department of Transportation —This symbol certifies that the tire is in compliance with the U.S. Department of Transportation tire safety standards, and is approved for highway use. |
| MA | = Code representing the tire manufacturing location. (2 digits) |
| L9 | = Code representing the tire size. (2 digits) |
| ABCD | = Code used by tire manufacturer. (1 to 4 digits) |
| 03 | = Number representing the week in which the tire was manufactured. (2 digits) —03 means the 3rd week. |
| 01 | = Number representing the year in which the tire was manufactured. (2 digits) —01 means the year 2001. —Prior to July 2000, tire manufacturers were only required to have 1 number to represent the year in which the tire was manufactured. Example: 031 could represent the 3rd week of 1981 or 1991. |

Tire Loading and Tire Pressure

Tire Placard Location

NOTE: The proper cold tire inflation pressure is listed on either the face of the driver's door or the driver's side "B" pillar.

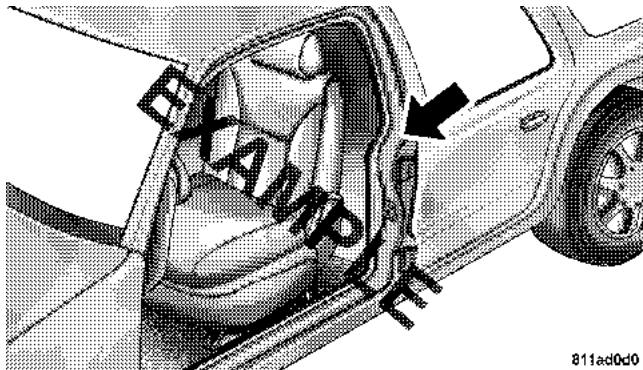

Tire Placard Location

811ad0d0

Tire and Loading Information Placard

TIRE AND LOADING INFORMATION

SEATING CAPACITY - TOTAL 5 FRONT 2 REAR 3

THE COMBINED WEIGHT OF OCCUPANTS AND CARGO SHOULD NOT EXCEED XXX KG OR XXX LBS.

| TIRE | FRONT | REAR | SPARE |
|------------------------------|---------------|---------------|---------------|
| ORIGINAL TIRE SIZE: | P195/70R14 | P195/70R14 | T125/70D15 |
| COLD TIRE INFLATION PRESSURE | 200kPa, 29PSI | 200kPa, 29PSI | 420kPa, 60PSI |

SEE OWNER'S MANUAL FOR ADDITIONAL INFORMATION

4N109268

811b5a9a

Tire and Loading Information

This placard tells you important information about the:

- 1) number of people that can be carried in the vehicle
- 2) the total weight your vehicle can carry
- 3) the tire size designed for your vehicle
- 4) the cold tire inflation pressures for the front, rear and spare tires.

Loading

The vehicle maximum load on the tire must not exceed the load carrying capacity of the tire on your vehicle. You will not exceed the tire's load carrying capacity if you adhere to the loading conditions, tire size, and cold tire inflation pressures specified on the "Tire and Loading Information" placard and in the "Vehicle Loading" section of this manual.

NOTE: Under a maximum loaded vehicle condition, gross axle weight ratings (GAWR's) for the front and rear axles must not be exceeded. For further information on GAWR's, vehicle loading, and trailer towing, refer to the "Vehicle Loading" section of this manual.

To determine the maximum loading conditions of your vehicle, locate the statement "The combined weight of occupants and cargo should never exceed XXX kg or XXX lbs." on the Tire and Loading Information placard. The combined weight of occupants, cargo/luggage and trailer tongue weight (if applicable) should never exceed the weight referenced here.

Steps for Determining Correct Load Limit

1. Locate the statement "The combined weight of occupants and cargo should never exceed XXX pounds" on your vehicle's placard.
2. Determine the combined weight of the driver and passengers that will be riding in your vehicle.
3. Subtract the combined weight of the driver and passengers from XXX kilograms or XXX pounds.
4. The resulting figure equals the available amount of cargo and luggage load capacity. For example, if "XXX" amount equals 1400 lbs. and there will be five 150 lb. passengers in your vehicle, the amount of available cargo and luggage load capacity is 650 lbs. (since $5 \times 150 = 750$, and $1400 - 750 = 650$ lbs.)
5. Determine the combined weight of luggage and cargo being loaded on the vehicle. That weight may not safely exceed the available cargo and luggage load capacity calculated in Step 4.
6. If your vehicle will be towing a trailer, load from your trailer will be transferred to your vehicle. Consult this

manual to determine how this reduces the available cargo and luggage load capacity of your vehicle.

NOTE: The following table shows examples on how to calculate total load, cargo/luggage, and towing capacities of your vehicle with varying seating configurations and number and size of occupants. This table is for

illustration purposes only and may not be accurate for the seating and load carry capacity of your vehicle.

NOTE: For the following example, the combined weight of occupants and cargo should never exceed 865 lbs. (392 Kg).

| Occupants | | | Combined weight of occupants and cargo from Tire Placard | MINUS | Combined Occupant's weight | = | AVAILABLE Cargo/Luggage and Trailer Tongue Weight |
|-----------|-------|------|--|-------|----------------------------|---|---|
| TOTAL | FRONT | REAR | | | | | |
| EXAMPLE 1 | | | 865 lbs | minus | 670 lbs | = | 195 lbs |
| 5 | 2 | 3 | | | | | |
| EXAMPLE 2 | | | 865 lbs | minus | 540 lbs | = | 325 lbs |
| 3 | 2 | 1 | | | | | |
| EXAMPLE 3 | | | 865 lbs | minus | 400 lbs | = | 465 lbs |
| 2 | 2 | 0 | | | | | |

EXAMPLE

Occupant 1: 200 lbs
 Occupant 2: 130 lbs
 Occupant 3: 160 lbs
 Occupant 4: 100 lbs
 Occupant 5: 80 lbs
 TOTAL WEIGHT: 670 lbs

Occupant 1: 210 lbs
 Occupant 2: 180 lbs
 Occupant 3: 150 lbs
 TOTAL WEIGHT: 540 lbs

Occupant 1: 200 lbs
 Occupant 2: 200 lbs
 TOTAL WEIGHT: 400 lbs

WARNING!

Overloading of your tires is dangerous. Overloading can cause tire failure, affect vehicle handling, and increase your stopping distance. Use tires of the recommended load capacity for your vehicle. Never overload them.

TIRES — GENERAL INFORMATION**Tire Pressure**

Proper tire inflation pressure is essential to the safe and satisfactory operation of your vehicle. Three primary areas are affected by improper tire pressure:

*1. Safety—***WARNING!**

- Improperly inflated tires are dangerous and can cause accidents.
- Under inflation increases tire flexing and can result in tire failure.
- Over inflation reduces a tire's ability to cushion shock. Objects on the road and chuckholes can cause damage that result in tire failure.
- Unequal tire pressures can cause steering problems. You could lose control of your vehicle.
- Over inflated or under inflated tires can affect vehicle handling and can fail suddenly, resulting in loss of vehicle control.
- Unequal tire pressures from one side of the vehicle to the other can cause the vehicle to drift to the right or left.
- Always drive with each tire inflated to the recommended cold tire inflation pressure.

2. *Economy*—

Improper inflation pressures can cause uneven wear patterns to develop across the tire tread. These abnormal wear patterns will reduce tread life resulting in a need for earlier tire replacement. Under inflation, also increases tire rolling resistance and results in higher fuel consumption.

3. *Ride Comfort and Vehicle Stability*—

Proper tire inflation contributes to a comfortable ride. Over inflation produces a jarring and uncomfortable ride.

Tire Inflation Pressures

The proper cold tire inflation pressure is listed either on the face of the driver's door or on the driver's side "B" pillar.

Some vehicles may have Supplemental Tire Pressure Information for vehicle loads that are less than the maximum loaded vehicle condition. These pressure conditions will be found in the "Supplemental Tire Pressure Information" section of this manual.

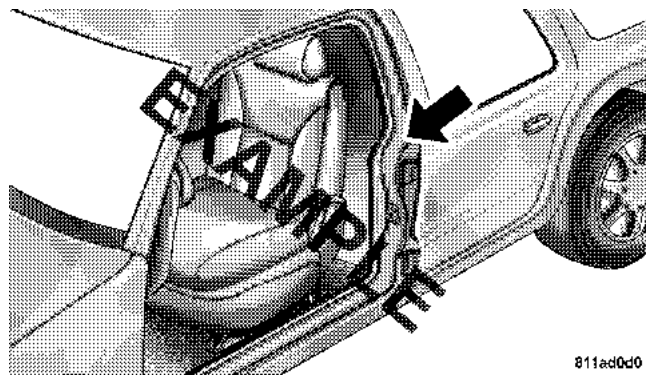

811ad0d0

Tire Placard Location

The pressure should be checked and adjusted as well as inspecting for signs of tire wear or visible damage at least once a month. Use a good quality pocket-type gauge to check tire pressure. Do not make a visual judgement when determining proper inflation. Radial tires may look properly inflated even when they are under inflated.

CAUTION!

After inspecting or adjusting the tire pressure, always reinstall the valve stem cap (if equipped). This will prevent moisture and dirt from entering the valve stem, which could damage the valve stem.

Inflation pressures specified on the placard are always “cold tire inflation pressure.” Cold tire inflation pressure is defined as the tire pressure after the vehicle has not been driven for at least 3 hours, or driven less than 1 mile (1 km) after a 3 hour period. The cold tire inflation pressure must not exceed the maximum inflation pressure molded into the tire sidewall.

Check tire pressures more often if subject to a wide range of outdoor temperatures, as tire pressures vary with temperature changes.

Tire pressures change by approximately 1 psi (7 kPa) per 12° F (7° C) of air temperature change. Keep this in mind when checking tire pressure inside a garage, especially in the winter.

Example: If garage temperature = 68° F (20° C) and the outside temperature = 32° F (0° C) then the cold tire inflation pressure should be increased by 3 psi (21 kPa), which equals 1 psi (7 kPa) for every 12° F (7° C) for this outside temperature condition.

Tire pressure may increase from 2 to 6 psi (13 to 40 kPa) during operation. DO NOT reduce this normal pressure build up or your tire pressure will be too low.

Tire Pressures for High Speed Operation

The manufacturer advocates driving at safe speeds within posted speed limits. Where speed limits or conditions are such that the vehicle can be driven at high speeds, maintaining correct tire inflation pressure is very important. Increased tire pressure and reduced vehicle loading may be required for high-speed vehicle operation. Refer to original equipment or an authorized tire dealer for recommended safe operating speeds, loading and cold tire inflation pressures.

WARNING!

High speed driving with your vehicle under maximum load is dangerous. The added strain on your tires could cause them to fail. You could have a serious accident. Don't drive a vehicle loaded to the maximum capacity at continuous speeds above 75 mph (120 km/h).

Radial-Ply Tires**WARNING!**

Combining radial ply tires with other types of tires on your vehicle will cause your vehicle to handle poorly. The instability could cause an accident. Always use radial ply tires in sets of four (or 6, in case of trucks with dual rear wheels). Never combine them with other types of tires.

Cuts and punctures in radial tires are repairable only in the tread area because of sidewall flexing. Consult your authorized tire dealer for radial tire repairs.

Tire Spinning

When stuck in mud, sand, snow, or ice conditions, do not spin your vehicle's wheels above 35 mph (55 km/h).

Refer to the paragraph on "Freeing A Stuck Vehicle" in Section 6 of this manual.

WARNING!

Fast spinning tires can be dangerous. Forces generated by excessive wheel speeds may cause tire damage or failure. A tire could explode and injure someone. Do not spin your vehicle's wheels faster than 30 mph (48 km/h) for more than 30 seconds continuously when you are stuck, and don't let anyone near a spinning wheel, no matter what the speed.

Tread Wear Indicators

Tread wear indicators are in the original equipment tires to help you in determining when your tires should be replaced.

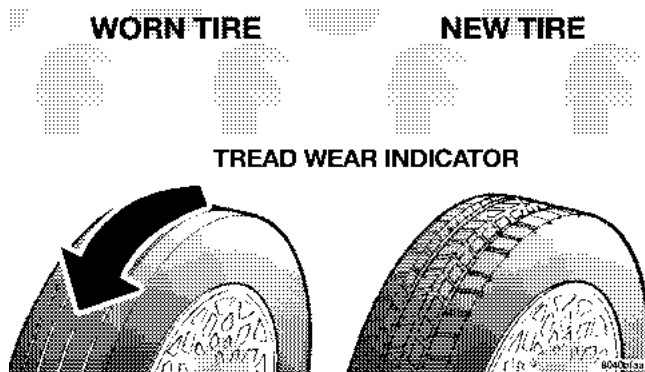

These indicators are molded into the bottom of the tread grooves. They will appear as bands when the tread depth becomes 1/16 inch (2 mm). When the tread is worn to the tread wear indicators, the tire should be replaced.

Many states have laws requiring tire replacement at this point.

Life of Tire

The service life of a tire is dependent upon varying factors including but not limited to:

- Driving style
- Tire pressure
- Distance driven

WARNING!

Tires and spare tire should be replaced after six years, regardless of the remaining tread. Failure to follow this warning can result in sudden tire failure. You could lose control and have an accident resulting in serious injury or death.

Keep dismantled tires in a cool, dry place with as little exposure to light as possible. Protect tires from contact with oil, grease, and gasoline.

Replacement Tires

The tires on your new vehicle provide a balance of many characteristics. They should be inspected regularly for wear and correct cold tire inflation pressure. The manufacturer strongly recommends that you use tires equivalent to the originals in size, quality and performance when replacement is needed (refer to the paragraph on “Tread Wear Indicators”). Refer to the “Tire and Loading Information” placard for the size designation of your tire. The service description and load identification will be found on the original equipment tire. Failure to use equivalent replacement tires may adversely affect the safety, handling, and ride of your vehicle. We recommend that you contact your original equipment or an authorized tire dealer with any questions you may have on tire specifications or capability.

WARNING!

- **Do not use a tire, wheel size or rating other than that specified for your vehicle. Some combinations of unapproved tires and wheels may change suspension dimensions and performance characteristics, resulting in changes to steering, handling, and braking of your vehicle. This can cause unpredictable handling and stress to steering and suspension components. You could lose control and have an accident resulting in serious injury or death. Use only the tire and wheel sizes with load ratings approved for your vehicle.**
- **Never use a tire with a smaller load index or capacity, other than what was originally equipped on your vehicle. Using a tire with a smaller load index could result in tire overloading and failure. You could lose control and have an accident.**
- **Failure to equip your vehicle with tires having adequate speed capability can result in sudden tire failure and loss of vehicle control.**

CAUTION!

Replacing original tires with tires of a different size may result in false speedometer and odometer readings.

Alignment And Balance

Poor suspension alignment may result in:

- Fast tire wear.
- Uneven tire wear, such as feathering and one-sided wear.
- Vehicle pull to right or left.

Tires may also cause the vehicle to pull to the left or right. Alignment will not correct this condition. See your dealer for proper diagnosis.

Improper alignment will not cause vehicle vibration. Vibration may be a result of tire and wheel out-of-balance. Proper balancing will reduce vibration and avoid tire cupping and spotty wear.

TIRE CHAINS

If driving conditions require tire chains for your vehicle, use only chains that meet SAE type "Class S" specifications. In addition, only install tire chains on 245/45ZR20 size tires. Contact your local dealership or tire dealer for these size tires.

CAUTION!

To avoid damage to your vehicle or tires, observe the following precautions:

- Because of restricted chain clearance between tires and other suspension components, it is important that only chains in good condition are used. Broken chains can cause serious damage. Stop the vehicle immediately if noise occurs that could indicate chain breakage. Remove the damaged parts of the chain before further use.
- Install chains on the rear wheels as tightly as possible and then retighten after driving about ½ mile (0.8 km).
- Do not exceed 30 mph (48 km/h).
- Drive cautiously and avoid severe turns and large bumps, especially with a loaded vehicle.
- Use on Rear Wheels only.
- Do not drive for prolonged period on dry pavement.
- Observe the tire chain manufacturer's instructions on the method of installation, operating speed, and conditions for use. Always use the lower suggested operating speed of the chain manufacturer if different from the speed recommended by the manufacturer.

NOTE: In order to avoid damage to tires, chains, and your vehicle do not drive for a prolonged period of time on dry pavement. Observe the tire chain manufacturer's instructions on method of installation, operating speed, and conditions for usage.

Always use the lower suggested operating speed if both the chain manufacturer and vehicle manufacture suggest a maximum speed. This notice applies to all chain traction devices, including link and cable (radial) chains.

SNOW TIRES

Some areas of the country require the use of snow tires during winter. Standard tires are of the all season type and satisfy this requirement as indicated by the M+S designation on the tire sidewall.

If you need snow tires, select tires equivalent in size and type to the original equipment tires. Use snow tires only in sets of 4, failure to do so may adversely affect the safety and handling of your vehicle.

Snow tires generally have lower speed ratings than what was originally equipped with your vehicle and should not be operated at sustained speeds over 75 mph (120 km/h).

TIRE ROTATION RECOMMENDATIONS

Tires on the front and rear axles of vehicles operate at different loads and perform different steering, driving, and braking functions. For these reasons, they wear at unequal rates, and tend to develop irregular wear patterns.

These effects can be reduced by timely rotation of tires. The benefits of rotation are especially worthwhile with aggressive tread designs such as those on all season type tires. Rotation will increase tread life, help to maintain mud, snow, and wet traction levels, and contribute to a smooth, quiet ride.

Follow the “Maintenance Schedules” in Section 8 of this manual for the recommended tire rotation frequency for your type of driving. Remember, more frequent rotation is permissible if desired. Also, correct for anything causing rapid or unusual wear prior to performing the tire rotation.

Tire Rotation — Standard Tires

The suggested rotation method is the "side-to-side" as shown in the following diagram.

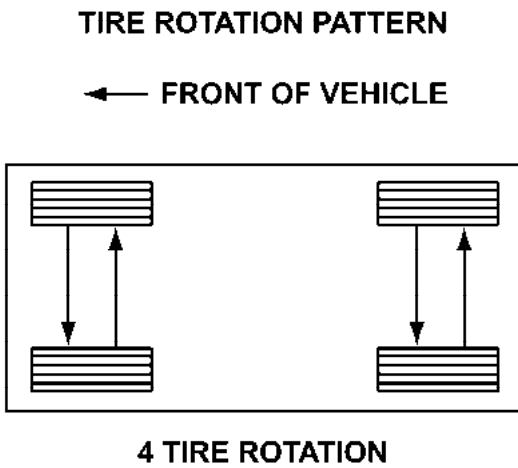

Tire Rotation — All Season Tires

The suggested rotation method for vehicles equipped with all season tires is the "forward-cross" as shown in the following diagram.

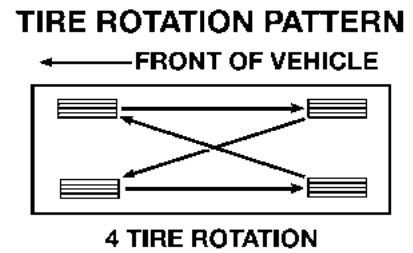

80ba79fe

TIRE PRESSURE MONITOR SYSTEM (TPMS) — IF EQUIPPED

- The Tire Pressure Monitor System (TPMS) will warn the driver of a low tire pressure based on the vehicle recommended cold placard pressure.
- The tire pressure will vary with temperature by about 1 psi (6.9 kPa) for every 12°F (6.5°C). This means that when the outside temperature decreases, the tire pressure will decrease. Tire pressure should always be set based on cold inflation tire pressure. This is defined as the tire pressure after the vehicle has not been driven for at least 3 hours, or driven less than 1 mile (1 km) after a 3 hour period. The cold tire inflation pressure must not exceed the maximum inflation pressure molded into the tire sidewall. Refer to the “Tires – General Information” in this section for information on how to properly inflate the vehicle’s tires. The tire pressure will also increase as the vehicle is driven - this is normal and there should be no adjustment for this increased pressure.
- The TPM System will warn the driver of a low tire pressure if the tire pressure falls below the low-pressure warning limit for any reason, including low temperature effects.
- The TPM System will continue to warn the driver of low tire pressure as long as the condition exists, and will not turn off until the tire pressure is at or above the recommended cold placard pressure. Once the low tire pressure warning (Tire Pressure Monitoring Telltale Light) illuminates, you must increase the tire pressure to the recommended cold placard pressure in order for the Tire Pressure Monitoring Telltale Light to turn off. The system will automatically update and the Tire Pressure Monitoring Telltale Light will turn off once the system receives the updated tire pressures. The vehicle may need to be driven for up to 10 minutes above 15 mph (25 km/h) in order for the TPMS to receive this information.

- For example, your vehicle may have a recommended cold (parked for more than 3 hours) placard pressure of 30 psi (207 kPa). If the ambient temperature is 68°F (20°C) and the measured tire pressure is 27 psi (186 kPa), a temperature drop to 20°F (-7°C) will decrease the tire pressure to approximately 23 psi (157 kPa). This tire pressure is sufficiently low enough to turn ON the Tire Pressure Monitoring Telltale light. Driving the vehicle may cause the tire pressure to rise to approximately 27 psi (186 kPa), but the Tire Pressure Monitoring Telltale Light will still be ON. In this situation, the Tire Pressure Monitoring Telltale Light will turn OFF only after the tires are inflated to the vehicle's recommended cold placard pressure value.

NOTE: Seasonal temperature changes will affect tire pressure, and the TPMS will monitor the actual tire pressure in the tire.

CAUTION!

- The TPMS has been optimized for the original equipment tires and wheels. TPMS pressures and warning have been established for the tire size equipped on your vehicle. Undesirable system operation or sensor damage may result when using replacement equipment that is not of the same size, type, and/or style. After-market wheels can cause sensor damage. Do not use tire sealant from a can, or balance beads if your vehicle is equipped with a TPMS, as damage to the sensors may result.
- After inspecting or adjusting the tire pressure, always reinstall the valve stem cap. This will prevent moisture and dirt from entering the valve stem, which could damage the Tire Pressure Monitoring Sensor.

NOTE:

- The TPMS is not intended to replace normal tire care and maintenance, or to provide warning of a tire failure or condition.
- The TPMS should not be used as a tire pressure gauge while adjusting your tire pressure.
- Driving on a significantly under-inflated tire causes the tire to overheat and can lead to tire failure. Under-inflation also reduces fuel efficiency and tire tread life, and may affect the vehicle's handling and stopping ability.
- The TPMS is not a substitute for proper tire maintenance, and it is the driver's responsibility to maintain correct tire pressure, even if under-inflation has not reached the level to trigger illumination of the Tire Pressure Monitoring Telltale light.

Base System — If Equipped

The Tire Pressure Monitor System (TPMS) uses wireless technology with wheel rim mounted electronic sensors to

monitor tire pressure levels. Sensors, mounted to each wheel as part of the valve stem, transmit tire pressure readings to the Receiver Module.

NOTE: It is particularly important for you to check the tire pressure in all of the tires on your vehicle regularly and to maintain the proper pressure.

The TPMS consists of the following components:

- Receiver Module
- 4 Tire Pressure Monitoring Sensors
- Tire Pressure Monitoring Telltale Light

Tire Pressure Monitoring Low Pressure Warnings

The Tire Pressure Monitoring Telltale Light will illuminate in the instrument cluster and an audible chime will sound when tire pressure is low in one or more of the four active road tires. The audible chime will sound once every ignition cycle for each condition that it detects. Should this occur, you should stop as soon as possible, check the inflation pressure of each tire on your vehicle, and inflate each tire to the vehicle's recommended cold placard pressure value. Once the system

receives the updated tire pressures, the system will automatically update and the Tire Pressure Monitoring Telltale Light will turn off. The vehicle may need to be driven for up to 10 minutes above 15 mph (25 km/h) in order for the TPMS to receive this information. Low pressure in the spare tire will not cause the Tire Pressure Monitoring Telltale Light to illuminate or the chime to sound.

NOTE: The compact spare tire (if so equipped) does not have a tire pressure monitoring sensor. Therefore, the TPMS will not monitor the pressure in the compact spare tire. However, if you install the compact spare tire in place of a road tire that has a pressure below the low-pressure warning limit, the Tire Pressure Monitoring Telltale Light will remain ON and a chime will still sound each ignition key cycle. Once you repair or replace the original road tire, and reinstall it on the vehicle in place of the compact spare, the TPMS will update automatically and the Tire Pressure Monitoring Telltale Light will turn OFF, as long no tire pressure is below the low-pressure warning limit in any of the four active road tires. The

vehicle may need to be driven for up to 10 minutes above 15 mph (25 km/h) in order for the TPMS to receive this information.

Check TPMS Warning

The Tire Pressure Monitoring Telltale Light will flash on and off for 60 seconds and an audible chime will sound when a system fault is detected. The flash cycle will repeat every ten minutes, without an audible chime, until the fault condition no longer exists. If the ignition key is cycled, this sequence will repeat, providing the system fault still exists.

Premium System — If Equipped

The Tire Pressure Monitor System (TPMS) uses wireless technology with wheel rim mounted electronic sensors to monitor tire pressure levels. Sensors, mounted to each wheel as part of the valve stem, transmit tire pressure readings to the Receiver Module.

NOTE: It is particularly important for you to check the tire pressure in all of the tires on your vehicle regularly and to maintain the proper pressure.

The TPMS consists of the following components:

- Receiver Module
- 4 Tire Pressure Monitoring Sensors
- 3 Trigger Modules (mounted in three of the four wheel-wells)
- Various Tire Pressure Monitoring System Messages, which display in the Electronic Vehicle Information Center (EVIC)
- Tire Pressure Monitoring Telltale Light

Tire Pressure Monitoring Low Pressure Warnings

 The Tire Pressure Monitoring Telltale Light will illuminate in the instrument cluster and an audible chime will sound when tire pressure is low in one or more of the four active road tires. The audible chime will sound once every ignition cycle for each condition that it detects. In addition, the Electronic Vehicle Information Center (EVIC) will display one or more Low Pressure messages (Left Front, Left Rear, Right Front, Right Rear) for 3 seconds and a graphic showing the pressure values of each tire with the low tire pressure

values flashing. Should this occur, you should stop as soon as possible, and inflate the tires with low pressure (those flashing in the EVIC graphic) to the vehicle's recommended cold placard pressure value. Once the system receives the updated tire pressures, the system will automatically update, the graphic display in the EVIC will stop flashing, and the Tire Pressure Monitoring Telltale Light will turn off. The vehicle may need to be driven for up to 10 minutes above 15 mph (25 km/h) in order for the TPMS to receive this information. Low pressure in the spare tire will not cause the Tire Pressure Monitoring Telltale Light to illuminate or the chime to sound.

EXAMPLE ONLY

Low Tire PSI

27  30

27  21

2345 mi

819793fc

NOTE:

- You can change the pressure units to display in PSI, kPA, or BAR. Refer to "Language," under "Personal Settings (Customer Programmable Features)," under "Electronic Vehicle Information Center (EVIC)" in Section 4 of this manual for details.
- The compact spare tire (if so equipped) does not have a tire pressure monitoring sensor. Therefore, the TPMS will not monitor the pressure in the compact spare tire. However, if you install the compact spare tire in place

of a road tire that has a pressure below the low-pressure warning limit, the Tire Pressure Monitoring Telltale Light will remain ON and a chime will still sound each ignition key cycle. In addition, the EVIC will still display a low-pressure message and a flashing pressure value in the graphic display. Once you repair or replace the original road tire, and reinstall it on the vehicle in place of the compact spare, the TPMS will update automatically. In addition, the Tire Pressure Monitoring Telltale Light will turn OFF, and the graphic in the EVIC will stop flashing and display a new pressure value, as long no tire pressure is below the low-pressure warning limit in any of the four active road tires. The vehicle may need to be driven for up to 10 minutes above 15 mph (25 km/h) in order for the TPMS to receive this information.

Check TPMS Warning

The Tire Pressure Monitoring Telltale Light will flash on and off for 60 seconds and an audible chime will sound when a system fault is detected. The flash cycle will repeat every ten minutes, without an audible chime, until the fault condition no longer exists. In addition to the telltale and chime, the Electronic Vehicle Information

Center (EVIC) will display a "CHECK TPM SYSTEM" message for 3 seconds when a system fault is detected. In the event that a fault occurs because the system did not receive a pressure value from one or more Tire Pressure Monitoring Sensors, the EVIC will display the "CHECK TPM SYSTEM" message and then display dashes (- -) in place of the pressure value to indicate which sensor is not being received.

EXAMPLE ONLY

```
Tire PSI
 30 33
 30 --
```



81979401

NOTE: You can change the pressure units to display in PSI, kPA, or BAR. Refer to "Language," under "Personal Settings (Customer Programmable Features)," under "Electronic Vehicle Information Center (EVIC)" in Section 4 of this manual for details.

If the ignition key is cycled, this sequence will repeat, providing the system fault still exists. If the system fault no longer exists, the Tire Pressure Monitoring Telltale Light will no longer flash, and the "CHECK TPM SYSTEM" message will no longer display, and a pressure value will display in place of the dashes.

General Information

This device complies with part 15 of the FCC rules and RSS 210 of Industry Canada. Operation is subject to the following conditions:

- This device may not cause harmful interference.
- This device must accept any interference received, including interference that may cause undesired operation.

The tire pressure sensors are covered under one of the following licenses:

- United States KR5S120123
- Canada 2671-S120123

FUEL REQUIREMENTS

6.1L Engine



The 6.1L engine is designed to meet all emissions regulations and provide excellent fuel economy and performance when using high-quality premium unleaded gasoline with an octane rating of 91 or higher.

Light spark knock at low engine speeds is not harmful to your engine. However, continued heavy spark knock at high speeds can cause damage and immediate service is required.

Poor quality gasoline can cause problems such as hard starting, stalling, and hesitations. If you experience these symptoms, try another brand of “premium” gasoline before considering service for the vehicle.

Over 40 automobile manufacturers around the world have issued and endorsed consistent gasoline specifications (the World Wide Fuel Charter, WWFC) which define fuel properties necessary to deliver enhanced emissions, engine performance, and durability for your vehicle. The manufacturer recommends the use of gasolines that meet the WWFC specifications if they are available.

Reformulated Gasoline

Many areas of the country require the use of cleaner burning gasoline referred to as “Reformulated Gasoline”.

Reformulated gasolines contain oxygenates, and are specifically blended to reduce vehicle emissions and improve air quality.

The manufacturer supports the use of reformulated gasolines. Properly blended reformulated gasolines will provide excellent performance and durability of engine and fuel system components.

Gasoline/Oxygenate Blends

Some fuel suppliers blend unleaded gasoline with oxygenates such as 10% ethanol, MTBE, and ETBE. Oxygenates are required in some areas of the country during the winter months to reduce carbon monoxide emissions. Fuels blended with these oxygenates may be used in your vehicle.

CAUTION!

DO NOT use gasolines containing Methanol or E85 Ethanol. Use of these blends may result in starting and driveability problems and may damage critical fuel system components.

Problems that result from using methanol/gasoline or E85 Ethanol blends are not the responsibility of the manufacturer. While MTBE is an oxygenate made from Methanol, it does not have the negative effects of Methanol.

MMT In Gasoline

MMT is a manganese containing metallic additive that is blended into some gasoline to increase the octane number. Gasolines blended with MMT offer no performance advantage beyond gasolines of the same octane number without MMT. Gasolines blended with MMT have shown to reduce spark plug life and reduce emission system performance in some vehicles. The manufacturer recommends using gasolines without MMT. Since the MMT content of gasoline may not be indicated on the pump, you should ask your gasoline retailer if his/her gasoline contains MMT.

It is even more important to look for gasolines without MMT in Canada, because MMT can be used at levels higher than allowed in the United States. MMT is prohibited in Federal and California reformulated gasolines.

Materials Added to Fuel

All gasoline sold in the United States is required to contain effective detergent additives. Use of additional detergents or other additives are not needed under

normal conditions and they would result in additional cost. Therefore, you should not have to add anything to the fuel.

Fuel System Cautions

| |
|---|
| CAUTION! |
| Follow these guidelines to maintain your vehicle's performance: |

- The use of leaded gas is prohibited by Federal law. Using leaded gasoline can impair engine performance, or damage the emission control system.
- An out-of-tune engine, or certain fuel or ignition malfunctions, can cause the catalytic converter to overheat. If you notice a pungent burning odor or some light smoke, your engine may be out-of-tune or malfunctioning and may require immediate service. Contact your dealer for service assistance.
- The use of fuel additives, which are now being sold as octane enhancers, are not recommended. Most of these

products contain high concentrations of methanol. Fuel system damage or vehicle performance problems resulting from the use of such fuels or additives are not the responsibility of the manufacturer.

NOTE: Intentional tampering with emissions control systems can result in civil penalties being assessed against you.

Carbon Monoxide Warnings

| |
|---|
| WARNING! |
| Carbon monoxide (CO) in exhaust gases is deadly. Follow the precautions below to prevent carbon monoxide poisoning: |

- Do not inhale exhaust gases. They contain carbon monoxide, a colorless and odorless gas, which can kill. Never run the engine in a closed area, such as a garage, and never sit in a parked vehicle with the engine running for an extended period. If the vehicle is stopped in an open area with the engine running for

more than a short period, adjust the ventilation system to force fresh, outside air into the vehicle.

- Guard against carbon monoxide with proper maintenance. Have the exhaust system inspected every time the vehicle is raised. Have any abnormal conditions repaired promptly. Until repaired, drive with all side windows fully open.
- Keep the trunk closed when driving your vehicle to prevent carbon monoxide and other poisonous exhaust gases from entering the vehicle.

ADDING FUEL

Fuel Filler Cap (Gas Cap)

The gas cap is located behind the fuel filler door on the left side of the vehicle. Push in on the left side (near the edge) of the fuel filler door to access the fuel filler cap. If the gas cap is lost or damaged, be sure the replacement cap is for use with this vehicle.

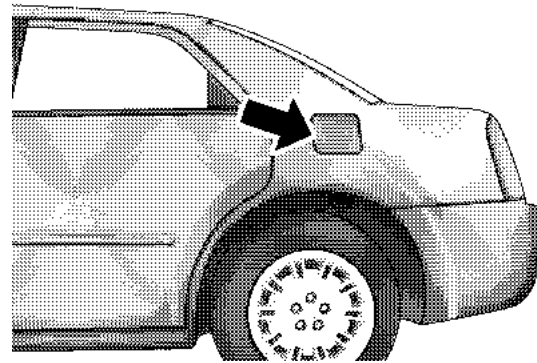

Fuel Filler Door

81368080

NOTE: When removing the fuel filler cap, lay the cap tether in the hook, located on the fuel filler cap door reinforcement.

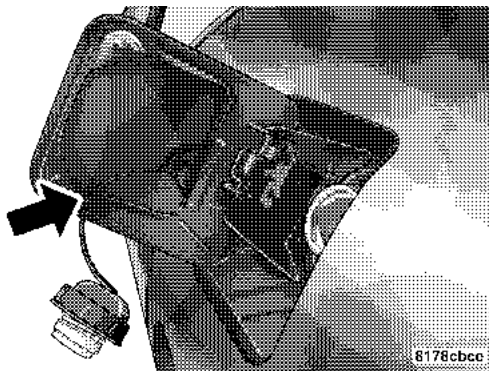

Gas Cap Tether Hook

CAUTION!

- Damage to the fuel system or emission control system could result from using an improper fuel tank filler tube cap (gas cap).
- A poorly fitting gas cap could let impurities into the fuel system.
- A poorly fitting gas cap may cause the Malfunction Indicator Light to turn on.
- To avoid fuel spillage and overfilling, do not “top off” the fuel tank after filling. When the fuel nozzle “clicks” or shuts off, the fuel tank is full.

WARNING!

- Never have any smoking materials lit in or near the vehicle when the gas cap is removed or the tank filled.
- Never add fuel to the vehicle when the engine is running.
- A fire may result if gasoline is pumped into a portable container that is inside of a vehicle. You could be burned. Always place gas containers on the ground while filling.

NOTE:

- Tighten the gas cap until you hear a “clicking” sound. This is an indication that the gas cap is tightened properly. The Malfunction Indicator Light in the instrument cluster may turn on if the gas cap is not secured properly. Make sure that the gas cap is tightened each time the vehicle is refueled.
- When the fuel nozzle “clicks” or shuts off, the fuel tank is full.

Loose Fuel Filler Cap Message

If the vehicle diagnostic system determines that the fuel filler cap is loose, improperly installed, or damaged, a “Check Gascap” message will display in the Electronic Vehicle Information Center (EVIC). If this occurs, tighten the fuel filler cap properly and press the odometer reset button to turn off the message. If the problem continues, the message will appear the next time the vehicle is started.

A loose, improperly installed, or damaged fuel filler cap may also turn on the Malfunction Indicator Light (MIL). Refer to “Onboard Diagnostic System” in Section 7 of this manual for more information.

VEHICLE LOADING

The load carrying capacity of your vehicle is shown on the “Vehicle Certification Label.” This information should be used for passenger and luggage loading as indicated.

If the seatbacks are folded for carrying cargo, do not exceed the specified GVWR and GAWR.

Vehicle Certification Label

Your vehicle has a certification label attached to the rear of the driver’s door.

The label contains the following information:

- Name of manufacturer
- Month and year of manufacture
- Gross Vehicle Weight Rating (GVWR)
- Gross Axle Weight Rating (GAWR) front
- Gross Axle Weight Rating (GAWR) rear
- Vehicle Identification Number (VIN)
- Type of Vehicle

- Month Day and Hour of Manufacture (MDH)

The bar code allows a computer scanner to read the Vehicle Identification Number (VIN).

Gross Vehicle Weight Rating (GVWR)

The GVWR is the total allowable weight of your vehicle. This includes driver, passengers, and cargo. The total load must be limited so that you do not exceed the GVWR.

Gross Axle Weight Rating (GAWR)

The GAWR is the maximum capacity of the front and rear axles. Distribute the load over the front and rear axles evenly. Make sure that you do not exceed either front or rear GAWR.

WARNING!

Because the front wheels steer the vehicle, it is important that you do not exceed the maximum front or rear GAWR. A dangerous driving condition can result if either rating is exceeded. You could lose control of the vehicle and have an accident.

Overloading

The load carrying components (axle, springs, tires, wheels, etc.) of your vehicle will provide satisfactory service as long as you do not exceed the GVWR and front and rear GAWR.

The best way to figure out the total weight of your vehicle is to weigh it when it is fully loaded and ready for operation. Weigh it on a commercial scale to insure that it is not over the GVWR.

Figure out the weight on the front and rear of the vehicle separately. It is important that you distribute the load evenly over the front and rear axles.

Overloading can cause potential safety hazards and shorten useful service life. Heavier axles or suspension components do not necessarily increase the vehicle's GVWR.

Loading

To load your vehicle properly, first figure out its empty weight, axle by axle and side by side. Store heavier items down low and be sure you distribute their weight as evenly as possible. Stow all loose items securely before

driving. If weighing the loaded vehicle shows that you have exceeded either GAWR, but the total load is within the specified GVWR, you must redistribute the weight. Improper weight distribution can have an adverse effect on the way your vehicle steers and handles and the way the brakes operate.

A loaded vehicle is shown in the illustration. Note that neither the GVWR nor the GAWR capacities have been exceeded.

GROSS VEHICLE WEIGHT RATING (GVWR) 2177 KG (4800 LBS)
(Example Only)

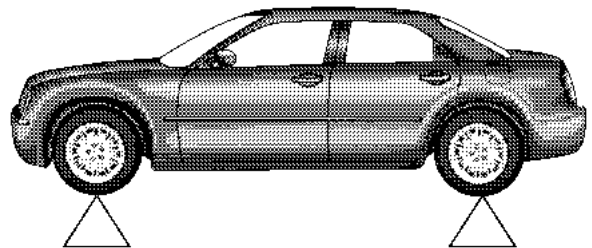

812cb8da

| EXAMPLE ONLY | Front Axle | Rear Axle |
|--|-----------------------|-----------------------|
| Empty Weight | 2054 lbs (932 kg) | 1805 lbs (819 kg) |
| Load (Including driver, passengers, and cargo) | 271 lbs (123 kg) | 579 lbs (263 kg) |
| Total | 2325 lbs (1055 kg) | 2384 lbs (1081 kg) |
| GAWR | 2546 lbs (1155 kg) | 2708 lbs (1228 kg) |

NOTE: Refer to the “Vehicle Certification Label” attached to the rear of the driver’s door for your vehicle’s GVWR and GAWRs. This table is only an example.

TRAILER TOWING

Trailer towing with this vehicle is not recommended.

RECREATIONAL TOWING (BEHIND MOTORHOME, ETC.)

TOWING THIS VEHICLE BEHIND ANOTHER VEHICLE (Flat towing with all four wheels on the ground)

Recreational towing for this vehicle is not recommended.

NOTE: If the vehicle requires towing, make sure all four wheels are off the ground.

GROUND CLEARANCE

CAUTION!

Damage to the front and rear fascias can occur if you disregard the low ground clearance in the front and rear of this vehicle. Pay close attention when parking to avoid running into parking curbs. Exercise caution when entering or exiting steep driveways or when pulling off the road onto soft shoulders.

WHAT TO DO IN EMERGENCIES

CONTENTS

| | | | |
|---------------------------------------|-----|---|-----|
| ■ Hazard Warning Flasher | 256 | □ Without The Ignition Key | 266 |
| ■ If Your Engine Overheats | 256 | □ Towing This Vehicle Behind Another Vehicle (Flat Towing With All Four Wheels On The Ground) | 266 |
| ■ TIREFIT Tire Repair | 257 | □ Towing This Vehicle Behind Another Vehicle With A Tow Dolly | 267 |
| ■ Jump-Starting Procedures | 262 | | |
| ■ Freeing A Stuck Vehicle | 265 | | |
| ■ Towing A Disabled Vehicle | 266 | | |

HAZARD WARNING FLASHER

The hazard flasher switch is located in the center of the instrument panel between the center air outlets.

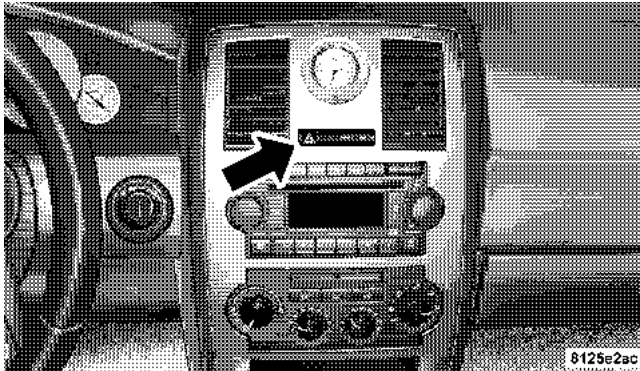

Hazard Flasher Switch

To engage the Hazard Warning Flashers, depress the switch on the instrument panel. When the Hazard Warning is activated, all directional turn signals will flash on and off to warn oncoming traffic of an emergency. Push the switch a second time to turn off the flashers.

This is an emergency warning system and it should not be used when the vehicle is in motion. Use it when your vehicle is disabled and it is creating a safety hazard for other motorists.

When you must leave the vehicle to seek assistance, the Hazard Warning Flashers will continue to operate even though the ignition switch is OFF.

NOTE: With extended use, the Hazard Warning Flashers may wear down your battery.

IF YOUR ENGINE OVERHEATS

In any of the following situations, you can reduce the potential for overheating by taking the appropriate action.

- On the highways — Slow down.
- In city traffic — While stopped, put transmission in neutral, but do not increase engine idle speed.

NOTE: There are steps that you can take to slow down an impending overheat condition. If your air conditioner is on, turn it off. The air conditioning system adds heat to the engine cooling system and turning off the A/C removes this heat. You can also turn the Temperature control to maximum heat, the Mode control to floor, and the fan control to HI. This allows the heater core to act as a supplement to the radiator and aids in removing heat from the engine cooling system.

CAUTION!

Driving with a hot cooling system could damage your vehicle. If temperature gauge reads 240°F (116°C) or greater pull over and stop the vehicle. Idle the vehicle with the air conditioner turned off until the pointer drops back into the normal range 200–230°F (93–110°C). If the pointer remains at 240°F (116°C) or greater and you hear a chime, turn the engine off immediately, and call for service.

WARNING!

A hot engine cooling system is dangerous. You or others could be badly burned by steam or boiling coolant. You may want to call a service center if your vehicle overheats. If you decide to look under the hood yourself, see Section 7, Maintenance, of this manual. Follow the warnings under the Cooling System Pressure Cap paragraph.

TIREFIT TIRE REPAIR

Small punctures, particularly those in the tread, can be sealed with TIREFIT. Foreign objects (e.g., screws or nails) should not be removed from the tire. TIREFIT can be used in outside temperatures down to approximately -4°F (-20°C).

The TIREFIT system is located under an access panel in the trunk.

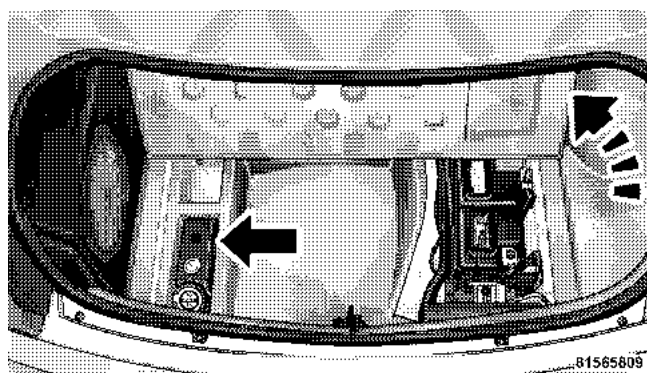

TIREFIT Location

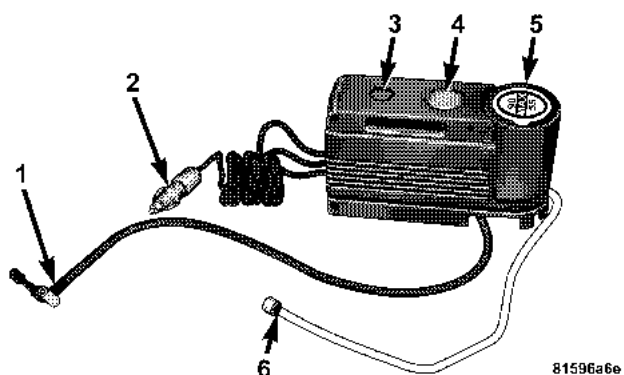

TIREFIT contents

1. Air pump hose
2. Power plug and cable
3. Air pump switch
4. Pressure gauge
5. TIREFIT sealant bottle
6. TIREFIT sealant hose

WARNING!

- Do not attempt to repair a tire on the side of the vehicle close to traffic. Pull far enough off the road to avoid the danger of being hit when operating the jack or repairing a tire.
- Cuts or punctures larger than approximately 0.16 in. (4 mm), tire damage caused by driving with extremely low tire pressure or on a flat tire, or a damaged wheel can pose a hazard while driving. TIREFIT should not be used in such circumstances. Do not drive the vehicle under such circumstances. Contact your nearest authorized dealer for assistance.
- Take care not to allow the contents of TIREFIT to come in contact with hair, eyes or clothing. TIREFIT is harmful if inhaled, swallowed, or absorbed through the skin: It causes skin, eye, and respiratory irritation. Any contact with eyes or skin should be flushed immediately with plenty of water. If clothing comes in contact with TIREFIT, change clothing as soon as possible.
- In case of allergic reaction or rash, consult a physician immediately. Keep TIREFIT out of reach of children. If swallowed, rinse mouth immediately with plenty of water and drink plenty of water. Do not induce vomiting! Consult a physician immediately.
- Keep away from open flame or heat source.

Sealing tire with TIREFIT

1. Turn on the hazard warning flashers.

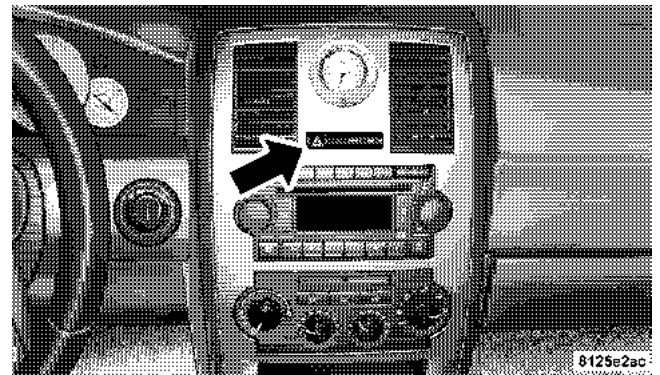
**Hazard Flasher Switch**

2. Move the transmission selector lever to the PARK position, turn off the engine, and set the parking brake.
3. Remove the TIREFIT kit from the trunk.
4. Pull the power plug (2) and the TIREFIT sealant hose (6) out from the TIREFIT kit.

5. Unscrew the valve cap from the valve on the deflated tire.
6. Screw the fitting at the end of TIREFIT sealant hose (6) coming from the sealant bottle (5) onto the tire valve.
7. Insert the power plug (2) into the power point on the instrument panel.
8. Leave the parking brake set and the transmission selector lever in PARK and start the engine.
9. Press the switch (3) on the air pump to I (ON). The air pump should start to inflate the tire and the tire sealant (white fluid) will flow from the sealant bottle (5) through the TIREFIT sealant hose (6) and into the tire.
10. Allow the air pump to run for five minutes and then read the pressure gauge (4). If the tire inflates to 26 psi (1.8 bar) or greater, proceed to Step 19 of this procedure. If not, proceed to the following step.
11. Press the air pump switch (3) to 0 (OFF). Then, disconnect the TIREFIT system from the tire and place it back in the vehicle.
12. Release the parking brake and drive the vehicle back and forth approximately 30 feet (9.1 m) to distribute the sealant more evenly within the tire.
13. Turn on the hazard warning flashers.
14. Move the transmission selector lever to the PARK position, turn off the engine, and set the parking brake.
15. Disconnect the air pump hose (1) from the underside of the sealant bottle (5) by flipping the hose valve open.
16. Connect the air pump hose valve to the tire valve and flip the hose valve closed.
17. Leave the parking brake set and the transmission selector lever in PARK and start the engine.
18. Press the switch (3) on the air pump to I (ON). The air pump should inflate the tire to at least 26 psi (1.8 bar) within five minutes. If the tire inflates to this level, proceed to the following step. **NOTE:** If a tire pressure of 26 psi (1.8 bar) is not obtained within five minutes, the tire is too badly damaged. Do not attempt to drive the vehicle further. Call for assistance.

19. With a tire pressure of no less than 26 psi (1.8 bar) press the air pump switch (3) to 0 (OFF) and turn off the engine. Then, disconnect the TIREFIT system from the tire and place it back in the vehicle.
20. Release the parking brake and drive the vehicle for approximately 10 minutes to ensure optimum distribution of the tire sealant within the tire.
21. Turn on the hazard warning flashers.
22. Move the transmission selector lever to the PARK position, turn off the engine, and set the parking brake.
23. Disconnect the air pump hose (1) from the underside of the sealant bottle (5) by flipping the hose valve open.
24. Connect the air pump hose valve to the tire valve and flip the hose valve closed.
25. Check the pressure in the tire by reading the pressure gauge (4). If the pressure is 19 psi (1.3 bar) or greater, proceed to the following step. **NOTE:** If the pressure is less than 19 psi (1.3 bar), the tire is too badly damaged. Do not attempt to drive the vehicle further. Call for assistance.
26. Leave the parking brake set and the transmission selector lever in PARK and start the engine.
27. Inflate the tire to the pressure indicated on the tire pressure label on the driver-side latch pillar by pressing the switch (3) on the air pump to I (ON) and watching the pressure gauge. When the tire pressure is set to the pressure indicated on the tire pressure label, press the air pump switch (3) to 0 (OFF) and turn off the engine.
28. Disconnect the TIREFIT system from the tire and reinstall the valve cap.
29. Place the sealant kit back in the trunk of the vehicle. Replace the sealant bottle at your nearest authorized MOPAR® parts dealership.
30. Have the tire inspected at the earliest opportunity at an authorized dealer or tire service center.

NOTE:

- If a pressure of at least 19 psi (1.3 bar) cannot be maintained in the tire, the tire is too badly damaged. Do not attempt to drive the vehicle further. Call for assistance.

- Do not operate the electric air pump for more than eight minutes to avoid overheating. The air pump may be used again once it has cooled down.
- Replace the TIREFIT sealant bottle (5) once every four years to assure optimum operation of the system.
- If TIREFIT is liquid, clean water and a damp cloth will remove the material from the vehicle or tire and wheel components. Once TIREFIT sealing material has dried, it can easily be peeled off and properly discarded.
- Do not exceed 55 mph (90 km/h) until the tire has been inspected.

JUMP-STARTING PROCEDURES

WARNING!

- Take care to avoid the radiator cooling fan whenever the hood is raised. It can start anytime the ignition switch is on. You can be hurt by the fan.
- Do not attempt to push or tow your vehicle to get it started. Vehicles equipped with an automatic transmission cannot be started this way. Unburned fuel could enter the catalytic converter and once the engine has started, ignite and damage the converter and vehicle. If the vehicle has a discharged battery, booster cables may be used to obtain a start from another vehicle. This type of start can be dangerous if done improperly, so follow this procedure carefully.
- Battery fluid is a corrosive acid solution; do not allow battery fluid to contact eyes, skin, or clothing. Don't lean over battery when attaching clamps or allow the clamps to touch each other. If acid splashes in eyes or on skin, flush contaminated area immediately with large quantities of water.
- A battery generates hydrogen gas, which is flammable and explosive. Keep flame or spark away from the vent holes.
- Do not use a booster battery or any other booster source with an output that exceeds 12 volts.
- The battery in this vehicle has a vent hose that should not be disconnected and should only be replaced with a battery of the same type (vented).

NOTE: The battery is stored under an access cover in the trunk. Remote battery terminals are located in the engine compartment for jump-starting.

1. Wear eye protection and remove any metal jewelry such as watchbands or bracelets that might make an inadvertent electrical contact.
2. When boost is provided by a battery in another vehicle, park that vehicle within booster cable reach, but do not allow the vehicles to touch one another.

WARNING!

Do not permit vehicles to touch each other as this could establish a ground connection and personal injury could result.

3. Set the parking brake, place the automatic transmission in PARK, and turn the ignition switch to the OFF (or LOCK) position on both vehicles.
4. Turn off the heater, radio, and all unnecessary electrical loads.

5. Connect one end of the jumper cable to the remote jump-start positive battery post (+) in the engine compartment. Connect the other end of the same cable to the positive terminal of the booster battery. Refer to the following illustration for jump-starting connections.

6. Connect the other cable, first to the negative terminal of the booster battery and **then to the engine ground (-) of the vehicle with the discharged battery.** Make sure you have a good contact on the engine ground. Refer to the following illustration for jump-starting connections.

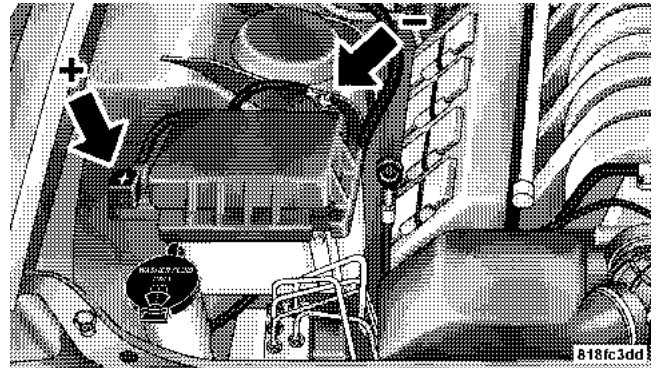

Jump-Starting

WARNING!

- You should not try to start your vehicle by pushing or towing.
- Do not connect the cable to the negative post of the discharge battery. The resulting electrical spark could cause the battery to explode.
- During cold weather when temperatures are below freezing point, electrolyte in a discharged battery may freeze. Do not attempt jump-starting because the battery could rupture or explode. The battery temperature must be brought up above freezing point before attempting jump-start.

7. Start the engine in the vehicle that has the booster battery. Let the engine idle a few minutes. Then, start the engine in the vehicle with the discharged battery.

NOTE: Refer to "Synchronizing ESP" under "Electronic Brake Control System" in Section 5 of this manual if the ESP/BAS light (in the instrument cluster) remains on continuously after starting the engine of the vehicle with the discharged battery.

8. When removing the jumper cables, reverse the above sequence exactly. Be careful of the moving belts and fan.

WARNING!

Any procedure other than above could result in:

1. Personal injury caused by electrolyte squirting out the battery vent;
2. Personal injury or property damage due to battery explosion;
3. Damage to charging system of booster vehicle or of immobilized vehicle.

FREEING A STUCK VEHICLE

If your vehicle becomes stuck in mud, sand, or snow, it can often be moved by a rocking motion. Turn your steering wheel right and left to clear the area around the front wheels. Then shift back and forth between Reverse and Drive. Usually the least accelerator pedal pressure to maintain the rocking motion without spinning the wheels is most effective.

NOTE: Turn off the Electronic Stability Program (ESP) before rocking the vehicle. For details, refer to “Electronic Stability Program,” or “Traction Control” in this manual.

CAUTION!

- When “rocking” a stuck vehicle by moving between “First” and R (Reverse), do not spin the wheels faster than 15 mph (24 km/h), or drivetrain damage may result.
- Racing the engine or spinning the wheels too fast may lead to transmission overheating and failure. It can also damage the tires. Do not spin the wheels above 35 mph (55 km/h).

WARNING!

Fast spinning tires can be dangerous. Forces generated by excessive wheel speeds may cause tire damage or failure. A tire could explode and injure someone. Do not spin your vehicle’s wheels faster than 35 mph (55 km/h) when you are stuck, and don’t let anyone near a spinning wheel, no matter what the speed.

TOWING A DISABLED VEHICLE

WITHOUT THE IGNITION KEY

Special care must be taken when the vehicle is towed with the ignition in the LOCK position. The only approved method of towing without the ignition key is with a flat bed truck. Proper towing equipment is necessary to prevent damage to the vehicle.

TOWING THIS VEHICLE BEHIND ANOTHER VEHICLE (Flat towing with all four wheels on the ground)

Flat towing of vehicles equipped with an automatic transmission, is only permitted within the following limitations:

With The Ignition Key

Your vehicle may be towed under the following conditions: The gear selector must be in NEUTRAL, the distance to be traveled must not exceed 30 miles (48 km), and the towing speed must not exceed 30 mph (48 km/h). Exceeding these towing limits may cause a transmission geartrain failure. If the transmission is not operative, or if the vehicle is to be towed more than 30 miles (48 km), the vehicle must be transported using a flat bed truck.

CAUTION!

- Do not attempt to tow this vehicle from the front with sling type towing equipment. Damage to the front fascia will result.
- If the transmission is not operative, or if the vehicle is to be towed more than 30 miles (48 km), then the only approved method of towing is with a flat bed truck. Damage to the transmission may result.
- Do not tow the vehicle from the rear. Damage to the rear sheet metal, and fascia will occur.
- Do not push or tow this vehicle with another vehicle as damage to the bumper fascia and transmission may result.

If you must use the accessories (wipers, defrosters, etc.) while being towed, the key must be in the ON position, not the ACCESSORY position. Make certain the transmission remains in NEUTRAL.

TOWING THIS VEHICLE BEHIND ANOTHER VEHICLE WITH A TOW DOLLY

The manufacture **does not recommend** that you tow this vehicle on a tow dolly. Vehicle damage may occur.

MAINTAINING YOUR VEHICLE

CONTENTS

| | | | |
|---|-----|---|-----|
| ■ 6.1L Engine Compartment | 271 | □ Engine Air Cleaner Filter | 279 |
| ■ Onboard Diagnostic System — OBD II | 272 | □ Fuel Filter | 279 |
| □ Loose Fuel Filler Cap | 272 | □ Catalytic Converter | 279 |
| ■ Emissions Inspection And Maintenance Programs | 273 | □ Maintenance-Free Battery | 281 |
| ■ Replacement Parts | 274 | □ Air Conditioner Maintenance | 282 |
| ■ Dealer Service | 274 | □ A/C Air Filter — If Equipped | 283 |
| ■ Maintenance Procedures | 275 | □ Power Steering — Fluid Check | 284 |
| □ Engine Oil | 275 | □ Front & Rear Suspension Ball Joints | 284 |
| □ Engine Oil Filter | 278 | □ Steering Linkage | 284 |
| □ Drive Belts — Check Condition And Tension | 278 | □ Body Lubrication | 284 |
| □ Spark Plugs | 278 | □ Windshield Wiper Blades | 285 |

270 MAINTAINING YOUR VEHICLE

| | | | |
|--|-----|---|-----|
| □ Windshield Washers/Headlight Washers | 285 | □ Fuses (Rear Power Distribution Center) | 302 |
| □ Exhaust System | 286 | ■ Vehicle Storage | 306 |
| □ Cooling System | 287 | ■ Replacement Bulbs | 307 |
| □ Hoses And Vacuum/Vapor Harnesses | 291 | ■ Bulb Replacement | 307 |
| □ Fuel System | 292 | □ Low Beam Headlight, High Beam Headlight, And Park/Turn Light | 307 |
| □ Brake System | 292 | □ Tail/Stop, Tail, Turn Signal Light, And Backup Light | 309 |
| □ Automatic Transmission | 294 | □ License Light | 312 |
| □ Front And Rear Wheel Bearings | 295 | ■ Fluids And Capacities | 313 |
| □ Appearance Care And Protection From Corrosion | 296 | ■ Fluids, Lubricants, And Genuine Parts | 314 |
| □ Cleaning The Center Console Cup Holders | 299 | □ Engine | 314 |
| ■ Fuses (Power Distribution Centers) | 300 | □ Chassis | 315 |
| □ Fuses (Front Power Distribution Center) | 300 | | |

6.1L ENGINE COMPARTMENT

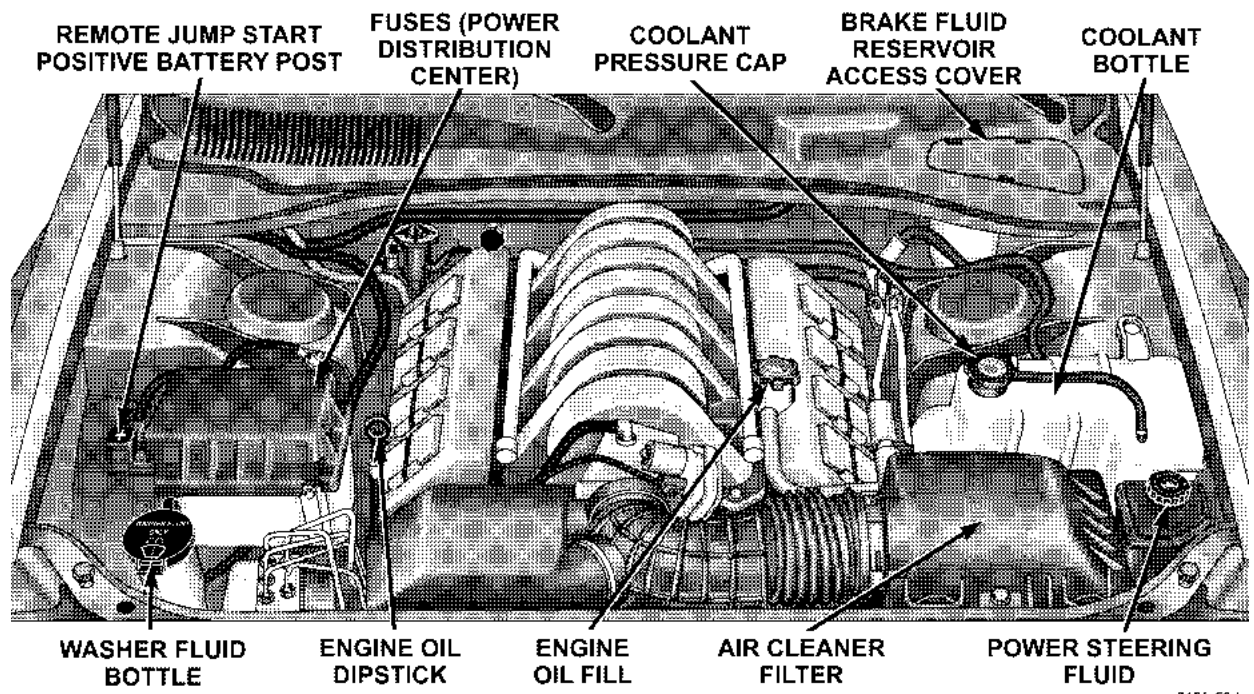

818fa56d

ONBOARD DIAGNOSTIC SYSTEM — OBD II

Your vehicle is equipped with a sophisticated onboard diagnostic system called OBD II. This system monitors the performance of the emissions, engine, and automatic transmission control systems. When these systems are operating properly, your vehicle will provide excellent performance and fuel economy, as well as engine emissions well within current government regulations.

If any of these systems require service, the OBD II system will turn on the “Malfunction Indicator Light.” It will also store diagnostic codes and other information to assist your service technician in making repairs. Although your vehicle will usually be drivable and not need towing, see your dealer for service as soon as possible.

CAUTION!

Prolonged driving with the “Malfunction Indicator Light” on could cause further damage to the emission control system. It could also affect fuel economy and driveability. The vehicle must be serviced before any emissions tests can be performed.

If the “Malfunction Indicator Light” is flashing while the engine is running, severe catalytic converter damage and power loss will soon occur. Immediate service is required.

Loose Fuel Filler Cap

If the vehicle diagnostic system determines that the fuel filler cap is loose, improperly installed, or damaged, a “Check Gas cap” message will display in the Electronic Vehicle Information Center (EVIC) — if equipped. If this occurs, tighten the fuel filler cap properly and press the odometer reset button to turn off the message. If the problem continues, the message will appear the next time the vehicle is started.

A loose, improperly installed, or damaged fuel filler cap may also turn on the Malfunction Indicator Light (MIL).

EMISSIONS INSPECTION AND MAINTENANCE PROGRAMS

In some localities, it may be a legal requirement to pass an inspection of your vehicle's emissions control system. Failure to pass could prevent vehicle registration.



For states, which have an I/M (Inspection and Maintenance) requirement, this check verifies the following: the MIL (Malfunction Indicator Lamp) is functioning and is not on when the engine is running, and that the OBD (On Board Diagnostic) system is ready for testing.

Normally, the OBD system will be ready. The OBD system may **not** be ready if your vehicle was recently serviced, if you recently had a dead battery, or a battery replacement. If the OBD system should be determined not ready for the I/M test, your vehicle may fail the test.

Your vehicle has a simple ignition key actuated test, which you can use prior to going to the test station. To check if your vehicle's OBD system is ready, you must do the following:

1. Insert your ignition key into the ignition switch.
2. Turn the ignition to the ON position, but do not crank or start the engine.
3. If you crank or start the engine, you will have to start this test over.
4. As soon as you turn your key to the ON position, you will see your MIL symbol come on as part of a normal bulb check.
5. Approximately 15 seconds later, one of two things will happen:
 - a. The MIL will flash for about 10 seconds and then return to being fully illuminated until you turn off the ignition key or start the engine. This means that your vehicle's OBD system is **not ready** and you should **not** proceed to the I/M station.

b. The MIL will not flash at all and will remain fully illuminated until you turn off the ignition key or start the engine. This means that your vehicle's OBD system is **ready** and you can proceed to the I/M station.

If your OBD system is **not ready**, you should see your authorized dealer or repair facility. If your vehicle was recently serviced or had a battery failure or replacement, you may need to do nothing more than drive your vehicle as you normally would in order for your OBD system to update. A recheck with the above test routine may then indicate that the system is now ready.

Regardless of whether your vehicle's OBD system is ready or not ready, if the MIL symbol is illuminated during normal vehicle operation, you should have your vehicle serviced before going to the I/M station. The I/M station can fail your vehicle because the MIL symbol is on with the engine running.

REPLACEMENT PARTS

Use of genuine Mopar® parts for normal/scheduled maintenance and repairs is highly recommended to insure the designed performance. Damage or failures caused by the use of non-Mopar® parts for maintenance and repairs will not be covered by the manufacturer's warranty.

DEALER SERVICE

Your dealer has the qualified service personnel, special tools, and equipment to perform all service operations in an expert manner. Service Manuals are available which include detailed service information for your vehicle. Refer to these manuals before attempting any procedure yourself.

NOTE: Intentional tampering with emissions control systems can result in civil penalties being assessed against you.

WARNING!

You can be badly injured working on or around a motor vehicle. Only do service work for which you have the knowledge and the proper equipment. If you have any doubt about your ability to perform a service job, take your vehicle to a competent mechanic.

MAINTENANCE PROCEDURES

The pages that follow contain the **required** maintenance services determined by the engineers who designed your vehicle.

Besides the maintenance items for which there are fixed maintenance intervals, there are other items that should operate satisfactorily without periodic maintenance. However, if a malfunction of these items does occur, it could adversely affect the engine or vehicle performance. These items should be inspected if a malfunction is observed or suspected.

Engine Oil**Checking Oil Level**

To assure proper engine lubrication, the engine oil must be maintained at the correct level. Check the oil level at regular intervals, such as every fuel stop.

The best time to check the engine oil level is about 5 minutes after a fully warmed engine is shut off or before starting the engine after it has sat overnight.

Checking the oil while the vehicle is on level ground will improve the accuracy of the oil level readings. Maintain the oil level in the "SAFE" range. Adding 1.0 quart (1.0L) of oil when the reading is at the bottom of the "SAFE" range will result in an oil level at the top of the "SAFE" range on these engines.

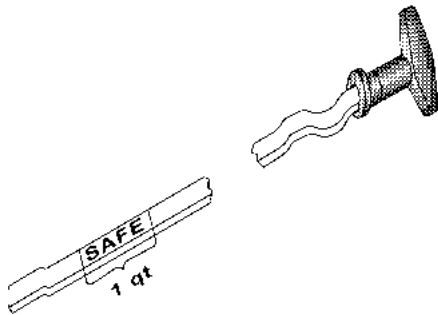

8131ee6a

Engine Oil Dipstick

CAUTION!

Overfilling or underfilling will cause oil aeration or loss of oil pressure. This could damage your engine.

Change Engine Oil

Road conditions and your kind of driving affect the interval at which your oil should be changed. Check the following list to see if any apply to you.

- Day or night temperatures are below 32°F (0°C).
- Stop and Go driving.
- Extensive engine idling.
- Driving in dusty conditions.
- Short trips of less than 10 miles (16 km).
- More than 50% of your driving is at sustained high speeds during hot weather, above 90°F (32°C).
- Trailer towing.
- Taxi, Police, or delivery service (commercial service).
- Off-Road or desert operation.

NOTE: If **ANY** of these apply to you, then change your engine oil every 3,000 miles (5 000 km) or 3 months, whichever comes first, and follow schedule "B" in the "Maintenance Schedules" in this manual.

If none of these applies to you, then change your engine oil at every interval shown on schedule "A" in the "Maintenance Schedules" in this manual.

NOTE: Under no circumstances should oil change intervals exceed 6,000 miles (10 000 km) or 6 months, whichever comes first.

Engine Oil Selection

For best performance and maximum protection under all types of operating conditions, the manufacturer only recommends full synthetic engine oils that meet the American Petroleum Institute (API) categories of SM or SM/CF, and meet the requirements of DaimlerChrysler Material Standard MS-10725.

The manufacturer recommends the use of a full synthetic engine oil, such as Mobil 1® SAE 0W-40 or equivalent.

Engine Oil Viscosity (SAE Grade)

The proper SAE viscosity grade of engine oil should be selected based on the following recommendation and be within the operating temperature shown in the engine oil viscosity chart.

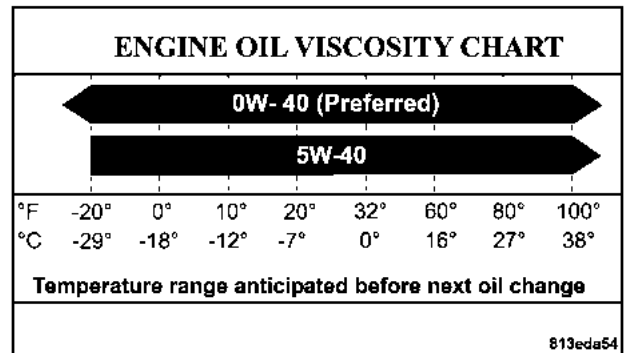

The engine oil filler cap also shows the recommended engine oil viscosity for your engine. For information on engine oil filler cap location, refer to the “Engine Compartment” illustration in this section.

Materials Added to Engine Oil

The manufacturer strongly recommends against the addition of any additives (other than leak detection dyes) to the engine oil. Engine oil is an engineered product and its performance may be impaired by supplemental additives.

Disposing of Used Engine Oil and Oil Filters

Care should be taken in disposing of used engine oil and oil filters from your vehicle. Used oil and oil filters, indiscriminately discarded, can present a problem to the environment. Contact your dealer, service station, or governmental agency for advice on how and where used oil and oil filters can be safely discarded in your area.

Engine Oil Filter

The engine oil filter should be replaced at every engine oil change.

Engine Oil Filter Selection

This manufacturer's engines have a full-flow type oil filter. Use a filter of this type for replacement. The quality of replacement filters varies considerably. Only high quality filters should be used to assure most efficient service. Mopar® Engine Oil Filters are a high quality oil filter and are recommended.

Drive Belts — Check Condition and Tension

Belt tension is controlled by means of an automatic tensioner. Therefore, no belt tension adjustments are required. However, belt and belt tensioner condition

should be inspected at the specified intervals and replaced if required. Improper belt tension can cause belt slippage and failure. Low generator belt tension can cause battery failure.

At the mileage indicated in the maintenance schedule, inspect belt and belt tensioner condition. Inspect belts for evidence of cuts, cracks, glazing, or frayed cords and replaced if there is indication of damage, which could result in belt failure. Also, check belt routing to make sure there is no interference between the belts and other engine components. See your authorized dealer for service.

Spark Plugs

Spark plugs must fire properly to assure engine performance and emission control. New plugs should be installed at the specified mileage. The entire set should be replaced if there is any malfunction due to a faulty spark plug. Malfunctioning spark plugs can damage the catalytic converter. For proper type of replacement spark plugs, refer to the "Vehicle Emission Control Information" label in the engine compartment.

Engine Air Cleaner Filter

For normal driving conditions, inspect and replace the engine air cleaner filter at the intervals shown on Schedule "A." For vehicles driven frequently in dusty or under severe conditions, inspect and replace the engine air cleaner filter at the intervals shown on Schedule "B."

WARNING!

The air induction system (air cleaner, hoses, etc) can provide a measure of protection in the case of engine backfire. Do not remove the air induction system (air cleaner, hoses, etc) unless such removal is necessary for repair or maintenance. Make sure that no one is near the engine compartment before starting the vehicle with the air induction system (air cleaner, hoses, etc) removed. Failure to do so can result in serious personal injury.

Fuel Filter

A plugged fuel filter can cause stalling, limit the speed at which a vehicle can be driven or cause hard starting. Should an excessive amount of dirt accumulate in the fuel tank, filter replacement may be necessary. See your local dealer for service.

Catalytic Converter

The catalytic converter requires the use of unleaded fuel only. Leaded gasoline will destroy the effectiveness of the catalyst as an emission control device.

Under normal operating conditions, the catalytic converter will not require maintenance. However, it is important to keep the engine properly tuned to assure proper catalyst operation and prevent possible catalyst damage.

CAUTION!

Damage to the catalytic converter can result if your vehicle is not kept in proper operating condition. In the event of engine malfunction, particularly involving engine misfire or other apparent loss of performance, have your vehicle serviced promptly. Continued operation of your vehicle with a severe malfunction could cause the converter to overheat, resulting in possible damage to the converter and the vehicle.

NOTE: Intentional tampering with emissions control systems can result in civil penalties being assessed against you.

WARNING!

A hot exhaust system can start a fire if you park over materials that can burn. Such materials might be grass or leaves coming into contact with your exhaust system. Do not park or operate your vehicle in areas where your exhaust system can contact anything that can burn.

In unusual situations involving grossly malfunctioning engine operation, a scorching odor may indicate severe and abnormal catalyst overheating. If this should occur, safely bring the vehicle to a complete stop, shut the engine off, and allow the vehicle to cool. Thereafter, obtain service, including a tune-up to manufacturer's specifications immediately.

To minimize the possibility of catalyst damage:

- Do not shut off the engine or interrupt the ignition when the transmission is in gear and the vehicle is in motion.

- Do not try to start engine by pushing or towing the vehicle.
- Do not idle the engine with any spark plug wires disconnected or removed, such as when diagnostic testing, or for prolonged periods during very rough idling or malfunctioning operating conditions.

Maintenance-Free Battery

The top of the MAINTENANCE-FREE battery is permanently sealed. You will never have to add water, nor is periodic maintenance required.

NOTE: The battery is stored under an access cover in the trunk. Remote battery terminals are located in the engine compartment for jump-starting.

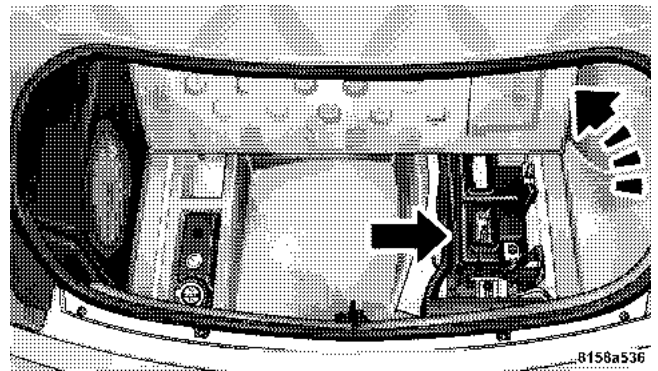

Battery Location

WARNING!

- Battery fluid is a corrosive acid solution and can burn or even blind you. Don't allow battery fluid to contact your eyes, skin, or clothing. Don't lean over a battery when attaching clamps. If acid splashes in eyes or on skin, flush the area immediately with large amounts of water.
- Battery gas is flammable and explosive. Keep flame or sparks away from the battery. Don't use a booster battery or any other booster source with an output greater than 12 volts. Don't allow cable clamps to touch each other.
- Battery posts, terminals, and related accessories contain lead and lead compounds. Wash hands after handling.
- The battery in this vehicle has a vent hose that should not be disconnected and should only be replaced with a battery of the same type (vented).

CAUTION!

- It is essential when replacing the cables on the battery that the positive cable is attached to the positive post and the negative cable is attached to the negative post. Battery posts are marked positive (+) and negative (-) and identified on the battery case. Cable clamps should be tight on the terminal posts and free of corrosion.
- If a "fast charger" is used while battery is in vehicle, disconnect both vehicle battery cables before connecting the charger to battery. Do not use a "fast charger" to provide starting voltage.

Air Conditioner Maintenance

For best possible performance, your air conditioner should be checked and serviced by an Authorized Dealer at the start of each warm season. This service should include cleaning of the condenser fins and a performance test. Drive belt tension should also be checked at this time.

WARNING!

- Use only refrigerants and compressor lubricants approved by the manufacturer for your air conditioning system. Some unapproved refrigerants are flammable and can explode, injuring you. Other unapproved refrigerants or lubricants can cause the system to fail, requiring costly repairs. Refer to Section 3 of the Warranty Information book for further warranty information.
- The air conditioning system contains refrigerant under high pressure. To avoid risk of personal injury or damage to the system, adding refrigerant or any repair requiring lines to be disconnected should be done by an experienced technician.

Refrigerant Recovery and Recycling

R-134a Air Conditioning Refrigerant is a hydrofluorocarbon (HFC) that is endorsed by the Environmental Protection Agency and is an ozone-saving product. However, the manufacturer recommends that air conditioning service be performed by dealers or other service facilities using recovery and recycling equipment.

NOTE: Use only manufacturer approved A/C System Sealers, Stop Leak Products, Seal Conditioners, Compressor Oil, and Refrigerants.

A/C Air Filter — If Equipped

The filter is located in the fresh air inlet under the hood, behind a removable panel in the cowl on the passenger side of the vehicle, next to the windshield wipers. When installing a new filter, ensure its proper orientation. To replace the filter remove the access door in the cowl screen by pressing the retaining clips. Slide the lid on the filter adapter forward and down and remove used filter. Install new filter with arrows pointing in the direction of airflow, which is toward the rear of the vehicle (text and arrows on the filter indicate this).

Refer to the “Maintenance Schedule” in this manual for the recommended air conditioning filter replacement intervals.

Power Steering — Fluid Check

Checking the power steering fluid level at a defined service interval is not required. The fluid should only be checked if a leak is suspected, abnormal noises are apparent, and/or the system is not functioning as anticipated. Coordinate inspection efforts through a certified DaimlerChrysler Dealership.

WARNING!

Fluid level should be checked on a level surface and with the engine off to prevent injury from moving parts and to insure accurate fluid level reading. Do not overfill. Use only manufacturer’s recommended power steering fluid.

If necessary, add fluid to restore to the proper indicated level. With a clean cloth, wipe any spilled fluid from all

surfaces. Refer to “Fluids, Lubricants, and Genuine Parts” in this section for the correct fluid type.

Front & Rear Suspension Ball Joints

The suspension ball joints should be inspected for external leakage or damage when other maintenance is performed.

Steering Linkage

The tie rod end ball joints should be inspected for external leakage or damage when other maintenance is performed.

Body Lubrication

Locks and all body pivot points, including seat tracks, door hinges, trunk hinges, and hood hinges, should be lubricated periodically to assure quiet, easy operation and to protect against rust and wear. Prior to the application of any lubricant, the parts concerned should be wiped clean to remove dust and grit; after lubricating excess oil and grease should be removed. Particular attention should also be given to hood latching components to insure proper function. When performing other underhood services, the hood latch, release mechanism, and safety catch should be cleaned and lubricated.

The external lock cylinders should be lubricated twice a year, preferably in the fall and spring. Apply a small amount of a high quality lubricant such as Mopar® Lock Cylinder Lubricant or equivalent directly into the lock cylinder.

Windshield Wiper Blades

The rubber edges of the wiper blades and the windshield should be cleaned periodically with a sponge or soft cloth and a mild nonabrasive cleaner. This will remove accumulations of salt or road film.

Operation of the wipers on dry glass for long periods may cause deterioration of the wiper blades. Always use washer fluid when using the wipers to remove salt or dirt from a dry windshield.

Avoid using the wiper blades to remove frost or ice from the windshield. Keep the blade rubber out of contact with petroleum products such as engine oil, gasoline, etc.

Windshield Washers/Headlight Washers

The windshield washer and the headlight washer share the same fluid reservoir. The fluid reservoir is located in the front of the engine compartment on the passenger side of the vehicle. Be sure to check the fluid level in the reservoir at regular intervals. Fill the reservoir with windshield washer solvent (not radiator antifreeze) and operate the system for a few seconds to flush out the residual water.

The fluid reservoir will hold nearly 1 gallon (4 liters) of washer fluid when the message “Low Washer Fluid” appears in the Electronic Vehicle Information Center (EVIC).

WARNING!

Commercially available windshield washer solvents are flammable. They could ignite and burn you. Care must be exercised when filling or working around the washer solution.

Exhaust System

The best protection against carbon monoxide entry into the vehicle body is a properly maintained engine exhaust system.

Whenever a change is noticed in the sound of the exhaust system, when exhaust fumes can be detected inside the vehicle, or when the underside or rear of the vehicle is damaged, have a competent mechanic inspect the complete exhaust system and adjacent body areas for broken, damaged, deteriorated, or mispositioned parts. Open seams or loose connections could permit exhaust fumes to seep into the passenger compartment. In addition, inspect the exhaust system each time the vehicle is raised for lubrication or oil change. Replace as required.

WARNING!

Exhaust gases can injure or kill. They contain carbon monoxide (CO) which is colorless and odorless. Breathing it can make you unconscious and can eventually poison you. To avoid breathing CO, refer to "Exhaust Gas" in the "Safety Tips" section of this manual.

Cooling System

WARNING!

- When working near the radiator cooling fan, disconnect the fan motor lead or turn the ignition switch to the OFF position. The fan is temperature controlled and can start at any time the ignition switch is in the ON position.
- You or others can be badly burned by hot coolant or steam from your radiator. If you see or hear steam coming from under the hood, don't open the hood until the radiator has had time to cool. Never try to open a cooling system pressure cap when the radiator is hot.

Coolant Checks

Check engine coolant (antifreeze) protection every 12 months (before the onset of freezing weather, where applicable). If coolant is dirty or rusty in appearance, the system should be drained, flushed and refilled with fresh coolant. Check the front of the A/C condenser for any

accumulation of bugs, leaves, etc. If dirty, clean by gently spraying water from a garden hose vertically down the face of the condenser.

Check the coolant recovery bottle tubing for brittle rubber, cracking, tears, cuts, and tightness of the connection at the bottle and radiator. Inspect the entire system for leaks.

With the engine at normal operating temperature (but not running), check the cooling system pressure cap for proper vacuum sealing by draining a small amount of coolant from the radiator drain cock. If the cap is sealing properly, the engine coolant (antifreeze) will begin to drain from the coolant recovery bottle. **DO NOT REMOVE THE COOLANT PRESSURE CAP WHEN THE COOLING SYSTEM IS HOT.**

Cooling System — Drain, Flush, and Refill

The system should be drained, flushed, and refilled at the intervals shown on the Maintenance Schedule.

If the solution is dirty or contains a considerable amount of sediment, clean and flush with a reliable cooling

system cleaner. Follow with a thorough rinsing to remove all deposits and chemicals. Properly dispose of old antifreeze solution.

Selection of Coolant

Use only the manufacturer's recommended coolant. Refer to "Fluids, Lubricants, and Genuine Parts" for the correct coolant type.

CAUTION!

- **Mixing of coolants other than specified HOAT engine coolants, may result in engine damage and may decrease corrosion protection. If a non-HOAT coolant is introduced into the cooling system in an emergency, it should be replaced with the specified coolant as soon as possible.**
- **Do not use plain water alone or alcohol-base engine coolant (antifreeze) products. Do not use additional rust inhibitors or antirust products, as they may not be compatible with the radiator engine coolant and may plug the radiator.**
- **This vehicle has not been designed for use with Propylene Glycol based coolants. Use of Propylene Glycol based coolants is not recommended.**

Adding Coolant

Your vehicle has been built with an improved engine coolant that allows extended maintenance intervals. This coolant can be used up to 5 Years or 100,000 miles (160 000 km) before replacement. To prevent reducing this extended maintenance period, it is important that you use the same coolant throughout the life of your vehicle. Please review these recommendations for using Hybrid Organic Additive Technology (HOAT) coolant.

When adding coolant:

- The manufacturer recommends using Mopar® Antifreeze/Coolant 5 Year/100,000 Mile Formula HOAT (Hybrid Organic Additive Technology).
- Mix a minimum solution of 50% HOAT engine coolant and distilled water. Use higher concentrations (not to exceed 70%) if temperatures below -34°F (-37°C) are anticipated.

- Use only high purity water such as distilled or deionized water when mixing the water/engine coolant solution. The use of lower quality water will reduce the amount of corrosion protection in the engine cooling system.

Please note that it is the owner's responsibility to maintain the proper level of protection against freezing according to the temperatures occurring in the area where the vehicle is operated.

NOTE: Mixing coolant types will decrease the life of the engine coolant and will require more frequent coolant changes.

Cooling System Pressure Cap

The cap must be fully tightened to prevent loss of coolant, and to insure that coolant will return to the radiator from the coolant recovery bottle.

The cap should be inspected and cleaned if there is any accumulation of foreign material on the sealing surfaces.

WARNING!

- The warning words “DO NOT OPEN HOT” on the cooling system pressure cap are a safety precaution. Never add coolant when the engine is overheated. Do not loosen or remove the cap to cool an overheated engine. Heat causes pressure to build up in the cooling system. To prevent scalding or injury, do not remove the pressure cap while the system is hot or under pressure.
- Do not use a pressure cap other than the one specified for your vehicle. Personal injury or engine damage may result.

Disposal of Used Coolant

Used ethylene glycol based engine coolant is a regulated substance requiring proper disposal. Check with your local authorities to determine the disposal rules for your community. To prevent ingestion by animals or children, do not store ethylene glycol based engine coolant in open containers or allow it to remain in puddles on the

ground. If ingested by a child, contact a physician immediately. Clean up any ground spills immediately.

Coolant Level

The coolant bottle provides a quick visual method for determining that the coolant level is adequate. With the engine off and cold, the level of the coolant in the bottle should be between the ranges indicated on the bottle.

The radiator normally remains completely full, so there is no need to remove the radiator cap unless checking for coolant freeze point or replacing coolant. Advise your service attendant of this. As long as the engine operating temperature is satisfactory, the coolant bottle need only be checked once a month.

When additional coolant is needed to maintain the proper level, it should be added to the coolant bottle. Do not overfill.

Points To Remember

NOTE: When the vehicle is stopped after a few miles (kilometers) of operation, you may observe vapor coming from the front of the engine compartment. This is normally a result of moisture from rain, snow, or high

humidity accumulating on the radiator and being vaporized when the thermostat opens, allowing hot coolant to enter the radiator.

If an examination of your engine compartment shows no evidence of radiator or hose leaks, the vehicle may be safely driven. The vapor will soon dissipate.

- Do not overfill the coolant recovery bottle.
- Check coolant freeze point in the radiator and in the coolant recovery bottle. If antifreeze needs to be added, contents of coolant recovery bottle must also be protected against freezing.
- If frequent coolant additions are required, or if the level in the coolant recovery bottle does not drop when the engine cools, the cooling system should be pressure tested for leaks.
- Maintain coolant concentration at 50% HOAT engine coolant (minimum) and distilled water for proper corrosion protection of your engine, which contains aluminum components.

- Make sure that the radiator and coolant recovery bottle overflow hoses are not kinked or obstructed.
- Keep the front of the radiator clean. If your vehicle is equipped with air conditioning, keep the front of the condenser clean, also.
- Do not change the thermostat for summer or winter operation. If replacement is ever necessary, install **ONLY** the correct type thermostat. Other designs may result in unsatisfactory coolant performance, poor gas mileage, and increased emissions.

Hoses and Vacuum/Vapor Harnesses

Inspect surfaces of hoses and nylon tubing for evidence of heat and mechanical damage. Hard or soft spots, brittle rubber, cracking, tears, cuts, abrasions, and excessive swelling indicate deterioration of the rubber.

Pay particular attention to those hoses nearest to high heat sources such as the exhaust manifold. Inspect hose routing to be sure hoses do not come in contact with any heat source or moving component, which may cause heat damage or mechanical wear.

Insure nylon tubing in these areas has not melted or collapsed.

Inspect all hose connections such as clamps and couplings to make sure they are secure and no leaks are present.

Components should be replaced immediately if there is any evidence of wear or damage that could cause failure.

Fuel System

The Electronic Fuel Injection high-pressure fuel system's hoses and quick connect fittings have unique material characteristics that provide adequate sealing and resist attack by deteriorated gasoline.

You are urged to use only the manufacture specified hoses with quick connect fittings, or their equivalent in material and specification, in any fuel system servicing. It is mandatory to replace any damaged hoses or quick connect fittings that have been removed during service. Care should be taken in installing quick connect fittings to insure they are properly installed and fully connected. See your authorized dealer for service.

Brake System

In order to assure brake system performance, all brake system components should be inspected periodically. Suggested service intervals can be found in the "Maintenance Schedule" in this manual.

WARNING!

Riding the brakes can lead to brake failure and possibly an accident. Driving with your foot resting or riding on the brake pedal can result in abnormally high brake temperatures, excessive lining wear, and possible brake damage. You wouldn't have your full braking capacity in an emergency.

Brake and Power Steering Hoses

When the vehicle is serviced for scheduled maintenance, inspect surface of hoses and nylon tubing for evidence of heat and mechanical damage. Hard and brittle rubber, cracking, tears, cuts, abrasion, and excessive swelling indicate deterioration of the rubber. Particular attention should be made to examining those hose surfaces nearest to high heat sources, such as the exhaust manifold.

Insure nylon tubing in these areas has not melted or collapsed.

Inspect all hose connections such as clamps and couplings to make sure they are secure and no leaks are present.

NOTE:

- Often, fluid such as oil, power steering fluid, and brake fluid are used during assembly plant operations to facilitate the assembly of hoses to couplings. Therefore, oil wetness at the hose-coupling area is not necessarily an indication of leakage. Actual dripping of hot fluid when systems are under pressure (during vehicle operation), should be noted before a hose is replaced based on leakage.
- Inspect the brake hoses whenever the brake system is serviced and at every engine oil change. Inspect hydraulic brake hoses for surface cracking, scuffing, or worn spots. If there is any evidence of cracking, scuffing, or worn spots, the hose should be replaced immediately! Eventual deterioration of the hose can take place resulting in a possibility of a burst failure.

WARNING!

Worn brake hoses can burst and cause brake failure. You could have an accident. If you see any signs of cracking, scuffing, or worn spots, have the brake hoses replaced immediately.

Master Cylinder - Brake Fluid Level Check

Check the fluid level in the master cylinder immediately if the brake system warning light indicates system failure.

Check the fluid level in the master cylinder when performing underhood services.

Clean the top of the master cylinder area before removing the cap. Add fluid to bring the level up to the top of the "FULL" mark on the side of the master cylinder reservoir.

Overfilling of fluid is not recommended because it may cause leaking in the system.

Add enough fluid to bring the level up to the requirements described on the brake fluid reservoir. With disc

brakes, fluid level can be expected to fall as the brake pads wear. However, low fluid level may be caused by a leak and a checkup may be needed.

Use only manufacturer's recommended brake fluid. Refer to "Fluids, Lubricants, and Genuine Parts" for the correct fluid type.

WARNING!

- **Overfilling the brake fluid reservoir can result in spilling brake fluid on hot engine parts and the brake fluid catching fire.**
- **Use of a brake fluid that has a lower initial boiling point than the recommended MOPAR® DOT 3 product or a brake fluid that is unidentified as to FMVSS specification may result in sudden brake failure during hard prolonged braking. You could have an accident.**

Use only brake fluid that has been in a tightly closed container to avoid contamination from foreign matter or moisture.

CAUTION!

Do not allow petroleum base fluid to contaminate the brake fluid, all brake seal components could be damaged causing partial or complete brake failure.

Automatic Transmission**Fluid Level Check**

Regular automatic transmission fluid level checks are not required. For this reason, the dipstick is omitted.

If you notice fluid loss or gear shift malfunction, have your authorized dealer check the transmission fluid level.

CAUTION!

- Using a transmission fluid other than the manufacturer's recommended fluid may cause deterioration in transmission shift quality and/or torque converter shudder. Using a transmission fluid other than that recommended by the manufacturer will result in more frequent fluid and filter changes. Refer to "Fluids, Lubricants, and Genuine Parts" for the correct fluid type.
- The fluid level is preset at the factory and it does not require adjustment under normal operating conditions. If a transmission fluid leak occurs, visit your authorized dealer immediately. Severe damage to the transmission may occur. Your authorized dealer has the proper tools to adjust the fluid level accurately.

Fluid and Filter Changes

Automatic transmission fluid and filter should be changed as follows:

Normal Usage — No change necessary

Severe Usage (fluid and filter) — Refer to Maintenance Schedule "B"

Severe Usage is defined as:

- Police, taxi, limousine, commercial type operation, or trailer towing where the vehicle is driven **regularly** for more than 45 minutes of continuous operation.

If the transmission is disassembled for any reason, the fluid and filter should be changed.

Special Additives

Automatic Transmission Fluid (ATF) is an engineered product and its performance may be impaired by supplemental additives. Therefore, do not add any fluid additives to the transmission. The only exception to this policy is the use of special dyes to aid in detecting fluid leaks. In addition, avoid using transmission sealers as they may adversely affect seals.

Front and Rear Wheel Bearings

Front and rear wheel bearings are permanently sealed. No regular maintenance is required for these components.

Appearance Care and Protection from Corrosion

Protection of Body and Paint from Corrosion

Vehicle body care requirements vary according to geographic locations and usage. Chemicals that make roads passable in snow and ice, and chemicals that are sprayed on trees and road surfaces during other seasons, are highly corrosive to the metal in your vehicle. Outside parking, which exposes your vehicle to airborne contaminants, road surfaces on which the vehicle is operated, extreme hot or cold weather and other extreme conditions will have an adverse effect on paint, metal trim, and underbody protection.

The following maintenance recommendations will enable you to obtain maximum benefit from the corrosion resistance built into your vehicle.

What Causes Corrosion?

Corrosion is the result of deterioration or removal of paint and protective coatings from your vehicle.

The most common causes are:

- Road salt, dirt, and moisture accumulation.

- Stone and gravel impact.
- Insects, tree sap, and tar.
- Salt in the air near seacoast localities.
- Atmospheric fallout/industrial pollutants.

Washing

- Wash your vehicle regularly. Always wash your vehicle in the shade using Mopar® Car Wash or a mild car wash soap, and rinse the panels completely with clear water.
- If insects, tar, or other similar deposits have accumulated on your vehicle, use Mopar® Super Kleen Bug and Tar Remover to remove.
- Use Mopar® Cleaner Wax to remove road film, stains and to protect your paint finish. Take care never to scratch the paint.
- Avoid using abrasive compounds and power buffing that may diminish the gloss or thin out the paint finish.

CAUTION!

Do not use abrasive or strong cleaning materials such as steel wool or scouring powder, which will scratch metal and painted surfaces.

Special Care

- If you drive on salted or dusty roads or if you drive near the ocean, hose off the undercarriage at least once a month.
- It is important that the drain holes in the lower edges of the doors, rocker panels, and trunk be kept clear and open.
- If you detect any stone chips or scratches in the paint, touch them up immediately. The cost of such repairs is considered the responsibility of the owner.
- If your vehicle is damaged due to an accident or similar cause, which destroys the paint and protective coating, have your vehicle repaired as soon as possible. The cost of such repairs is considered the responsibility of the owner.

- If you carry special cargo such as chemicals, fertilizers, de-icer salt, etc., be sure that such materials are well packaged and sealed.
- If a lot of driving is done on gravel roads, consider mud or stone shields behind each wheel.
- Use Mopar® touch up paint or equivalent on scratches as soon as possible. Your dealer has touch up paint to match the color of your vehicle.

Wheel and Wheel Trim Care

All wheels and wheel trim, especially aluminum and chrome plated wheels should be cleaned regularly with a mild soap and water to prevent corrosion. To remove heavy soil and/or excessive brake dust, use Mopar® Wheel Cleaner (05066247AB) or equivalent or select a nonabrasive, non-acidic cleaner. Do not use scouring pads, steel wool, a bristle brush, or metal polishes. Only Mopar® or equivalent is recommended. Do not use oven cleaner. Avoid automatic car washes that use acidic solutions or harsh brushes that may damage the wheels' protective finish.

Interior Care

Use Mopar® Fabric Cleaner or equivalent to clean fabric upholstery and Mopar® Carpet Cleaner for carpeting.

Interior Trim should be cleaned starting with a damp cloth, or Mopar® Satin Select. Do not use harsh cleaners or Armorall. Use Mopar® Total Clean to clean vinyl upholstery.

Mopar® Total Clean is specifically recommended for leather upholstery.

Your leather upholstery can be best preserved by regular cleaning with a damp soft cloth. Small particles of dirt can act as an abrasive and damage the leather upholstery and should be removed promptly with a damp cloth. Stubborn soils can be removed easily with a soft cloth and Mopar® Total Clean or equivalent. Care should be taken to avoid soaking your leather upholstery with any liquid. Please do not use polishes, oils, cleaning fluids, solvents, detergents, or ammonia-based cleaners to clean your leather upholstery. Application of a leather conditioner is not required to maintain the original condition.

WARNING!

Do not use volatile solvents for cleaning purposes. Many are potentially flammable, and if used in closed areas they may cause respiratory harm.

Cleaning Headlights

Your vehicle has plastic headlights that are lighter and less susceptible to stone breakage than glass headlights.

Plastic is not as scratch resistant as glass and therefore different lens cleaning procedures must be followed.

To minimize the possibility of scratching the lenses and reducing light output, avoid wiping with a dry cloth. To remove road dirt, wash with a mild soap solution followed by rinsing.

Do not use abrasive cleaning components, solvents, steel wool or other aggressive material to clean the lenses.

Glass Surfaces

All glass surfaces should be cleaned on a regular basis with Mopar® Glass Cleaner or any commercial household-type glass cleaner. Never use an abrasive type

cleaner. Use caution when cleaning the inside rear window equipped with electric defrosters or the right rear quarter window equipped with the radio antenna. Do not use scrapers or other sharp instruments, which may scratch the elements.

When cleaning the rear view mirror, spray cleaner on the towel or rag that you are using. Do not spray cleaner directly on the mirror.

Cleaning Plastic Instrument Cluster Lenses

The lenses in front of the instruments in this vehicle are molded in clear plastic. When cleaning the lenses, care must be taken to avoid scratching the plastic.

1. Clean with a wet soft rag or micro-fiber towel. A mild soap solution may be used, but do not use high alcohol content or abrasive cleaners. If soap is used, wipe clean with a clean damp rag.
2. Dry with a soft tissue.

Seat Belt Maintenance

Do not bleach, dye, or clean the belts with chemical solvents or abrasive cleaners. This will weaken the fabric. Sun damage can also weaken the fabric.

If the belts need cleaning, use Mopar® Total Clean, a mild soap solution, or lukewarm water. Do not remove the belts from the vehicle to wash them.

Replace the belts if they appear frayed or worn or if the buckles do not work properly.

Cleaning the Center Console Cup Holders

Clean with a damp cloth or towel using a mild detergent with the cup holder in the center console.

NOTE: The cup holder cannot be removed.

FUSES (POWER DISTRIBUTION CENTERS)**Fuses (Front Power Distribution Center)**

A power distribution center is located in the engine compartment. This center contains fuses and relays.

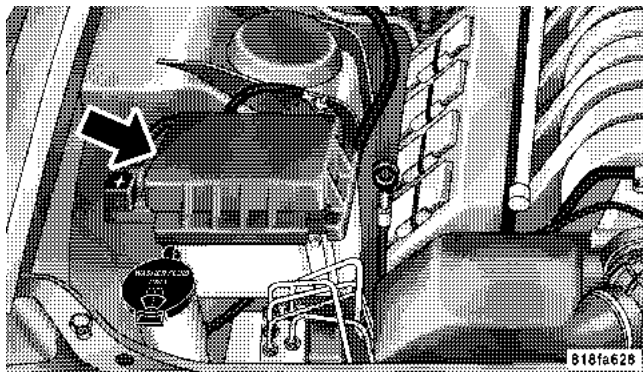

Front Power Distribution Center

| Cavity | Cartridge Fuse | Mini Fuse | Description |
|--------|----------------|---------------|---|
| 1 | — | 20 Amp Yellow | Left High Intensity Discharge (HID) Headlight |
| 2 | — | 20 Amp Yellow | Right High Intensity Discharge (HID) Headlight |
| 3 | — | 15 Amp Blue | Adjustable Pedals - if equipped |
| 4 | — | 20 Amp Yellow | AC Clutch/Horn |
| 5 | — | 20 Amp Yellow | Headlight Washer - If Equipped |
| 6 | — | 15 Amp Blue | Front Control Module (FCM) |
| 7 | — | 20 Amp Yellow | Fog Lights |
| 8 | — | 15 Amp Blue | Lights – License, Park, Side Marker, Stop, Turn |
| 9 | — | 15 Amp Blue | Front Control Module (FCM) |

| Cavity | Cartridge Fuse | Mini Fuse | Description |
|--------|----------------|---------------|--|
| 10 | — | 5 Amp Orange | Powertrain Control Module (PCM)/Starter |
| 11 | — | 25 Amp Clear | Auto Shutdown/Powertrain Control Module (PCM) |
| 12 | — | — | — |
| 13 | — | — | — |
| 14 | — | 25 Amp Clear | Powertrain Control Module (PCM) |
| 15 | — | 20 Amp yellow | Injectors, Ignition Coils |
| 16 | — | — | — |
| 17 | 30 Amp Pink | — | Anti-lock Brakes System (ABS) Valves/Powertrain Control Module (PCM) |
| 18 | 30 Amp Pink | — | Windshield Wiper/Washer |

| Cavity | Cartridge Fuse | Mini Fuse | Description |
|--------|----------------|-----------|--|
| 19 | 50 Amp Red | — | Radiator Fan |
| 20 | 20 Amp Blue | — | Starter |
| 21 | 50 Amp Red | — | Anti-lock Brakes System (ABS) Pump Motor |
| 22 | 40 Amp Green | — | AC Clutch/Radiator Fan High — Low |
| 23 | 50 Amp Red | — | High Intensity Lighting (HID) |
| 24 | 60 Amp Yellow | — | Radiator Fan |
| 25 | 30 Amp Pink | — | Front Control Module (FCM) |
| 26 | — | — | — |
| 27 | 30 Amp Pink | — | Front Control Module (FCM) |

CAUTION!

- When installing the Power Distribution Center cover, it is important to ensure the cover is properly positioned and fully latched. Failure to do so may allow water to get into the Power Distribution Center, and possibly result in an electrical system failure.
- When replacing a blown fuse, it is important to use only a fuse having the correct amperage rating. The use of a fuse with a rating other than indicated may result in a dangerous electrical system overload. If a properly rated fuse continues to blow, it indicates a problem in the circuit that must be corrected.

Fuses (Rear Power Distribution Center)

There is also a power distribution center located in the trunk under the spare tire access panel. This center contains fuses and relays.

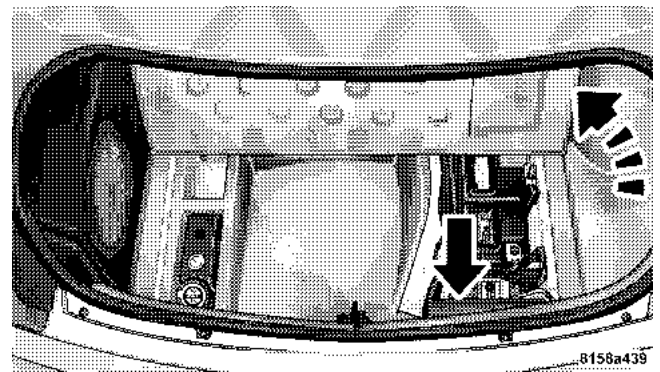

Rear Power Distribution Center

| Cavity | Cartridge Fuse | Mini Fuse | Description |
|--------|----------------|---------------|---|
| 1 | 60 Amp Yellow | — | Ignition Off Draw (IOD) |
| 2 | 40 Amp Green | — | Battery |
| 3 | — | — | — |
| 4 | 40 Amp Green | — | Battery |
| 5 | 40 Amp Green | — | Heated Seats - if equipped |
| 6 | — | 20 Amp Yellow | Fuel Pump |
| 7 | — | 20 Amp Yellow | Amplifier — Subwoofer |
| 8 | — | 15 Amp Blue | Ignition Switch/Airbag Control Module (ACM) |
| 9 | — | 20 Amp Yellow | Console Power Outlet |
| 10 | — | — | — |
| 11 * | — | — | — |

| Cavity | Cartridge Fuse | Mini Fuse | Description |
|--------|----------------|---------------|---|
| 12 * | — | — | — |
| 13 * | — | — | — |
| 14 | — | 10 Amp Red | AC Heater Control/Cluster/Sentry Key Remote Keyless Entry |
| 15 | — | — | — |
| 16 | — | — | — |
| 17 | — | 20 Amp Yellow | Cluster |
| 18 | — | 20 Amp Yellow | Selectable Power Outlet |
| 19 | — | 10 Amp Red | Stop Lights |
| 20 | — | — | — |
| 21 | — | — | — |
| 22 | — | — | — |
| 23 | — | — | — |
| 24 | — | — | — |
| 25 | — | — | — |

304 MAINTAINING YOUR VEHICLE

| Cavity | Cartridge Fuse | Mini Fuse | Description |
|--------|----------------|--------------|--|
| 26 | — | — | — |
| 27 | — | 10 Amp Red | Airbag/Airbag Control Module (ACM) |
| 28 | — | 10 Amp Red | Curtain Airbag - if equipped |
| 29 | — | 5 Amp Orange | Anti-lock Brakes Module/Cluster/Front Control Module (FCM)/Powertrain Control Module (PCM)/Sentry Key Remote Keyless Entry/Stop Lights |
| 30 | — | 10 Amp Red | Door Modules/Power Mirrors - if equipped/Steering Control Module |
| 31 | — | — | — |
| 32 | — | — | — |
| 33 | — | — | — |
| 34 | — | — | — |

| Cavity | Cartridge Fuse | Mini Fuse | Description |
|--------|----------------|---------------|--|
| 35 | — | 5 Amp Orange | Amplifier - if equipped/Antenna/Ignition Delay/Overhead Console/Passenger Door Lock & Express Power Window Switch - if equipped/Power Mirrors - if equipped/Rain Sensor - if equipped/Rear Defrost |
| 36 | — | 20 Amp Yellow | Hands Free Phone - if equipped/Media System Monitor DVD - if equipped/Radio/Satellite Receiver - if equipped |
| 37 | — | 15 Amp Blue | Transmission - NAG1 |
| 38 | — | 5 Amp Orange | Analog Clock/Cargo Light/Overhead Console |

| Cavity | Cartridge Fuse | Mini Fuse | Description |
|--------|----------------|------------|--|
| 39 | — | 10 Amp Red | Heated Mirrors - if equipped |
| 40 | — | 10 Amp Red | Heated Seats - if equipped/Inside Rear-view Mirror |
| 41 | — | 10 Amp Red | AC Heater Control/Park Assist - if equipped/Tire Pressure Monitoring - if equipped |
| 42 | 30 Amp Pink | — | Front Blower Motor |
| 43 | 30 Amp Pink | — | Amplifier - if equipped/Antenna/Rear Defrost |
| 44 | 20 Amp Blue | — | Amplifier - if equipped/Front Control Module (FCM)/Sunroof - if equipped |

* Cavities 11, 12, and 13 contain self-resetting fuses (circuit breakers) that are only serviceable by an authorized dealer. The Cluster (without power memory seat), the Driver Seat Switch (with power memory seat), and the Memory Module (if equipped) are fused by the 25 amp circuit breaker in Cavity 11. The Passenger Seat Switch is fused by the 25 amp circuit breaker in Cavity 12. The Door Modules (except base), the Driver Door Lock Switch (base), the Driver Express Power Window Switch (if equipped), and the Passenger Door Lock Switch (base) are fused by the 25 amp circuit breaker in Cavity 13. If you experience temporary or permanent loss of these systems, see your authorized dealer for service.

CAUTION!

- When installing the Power Distribution Center cover, it is important to ensure the cover is properly positioned and fully latched. Failure to do so may allow water to get into the Power Distribution Center, and possibly result in an electrical system failure.
- When replacing a blown fuse, it is important to use only a fuse having the correct amperage rating. The use of a fuse with a rating other than indicated may result in a dangerous electrical system overload. If a properly rated fuse continues to blow, it indicates a problem in the circuit that must be corrected.

VEHICLE STORAGE

If you are leaving your vehicle dormant for more than 21 days, you may want to take steps to protect your battery. You may:

- Disconnect the negative cable from the battery.
- Anytime you store your vehicle, or keep it out of service (i.e. vacation) for two weeks or more, run the air conditioning system at idle for about five minutes in the fresh air and high blower setting. This will insure adequate system lubrication to minimize the possibility of compressor damage when the system is started again.

REPLACEMENT BULBS

| LIGHT BULBS — Interior | Bulb Number |
|---|--------------------|
| Rear Courtesy/Reading Lights | W5W |
| Rear Compartment (Trunk) Light | 579 |
| Overhead Console Reading Lights | 578 |
| Visor Vanity Lights | A6220 |
| Glove Box Light | 194 |
| Door Courtesy | 562 |
| Shift Indicator Light | JKLE14140 |

NOTE: For lighted switches, see your dealer for replacement instructions.

All of the interior bulbs are glass wedge base or glass cartridge types. Aluminum base bulbs are not approved and should not be used for replacement.

| LIGHT BULBS — Exterior | Bulb Number |
|---|-----------------------------|
| Low Beam Headlight – High Intensity Discharge (HID) | D1S (Serviced at Dealer) |
| High Beam Headlight | 9005 |
| Front Park/Turn Light | 3157AK |

| | |
|--|-------------------------------|
| Front Fog Light | 9145/H10 (Serviced at Dealer) |
| Front Side Marker | W5W (Serviced at Dealer) |
| Tail/Stop Light | 3057 |
| Tail Light | 3057 |
| Turn Signal Light | 3057 |
| Backup Light | 3057 |
| Center High Mount Stop Light (CHMSL) | LED |
| License | W5W |

BULB REPLACEMENT

Low Beam Headlight, High Beam Headlight, and Park/Turn Light

High Intensity Discharge Headlights (HID)

The headlights are a type of high voltage discharge tube. High voltage can remain in the circuit even with the headlight switch off and the key removed. **Because of this, you should not attempt to service a headlight bulb yourself. If a headlight bulb fails, take your vehicle to an authorized dealer for service.**

WARNING!

A transient high tension occurs at the bulb sockets of High Intensity Discharge (HID) headlights when the headlight switch is turned ON. It may cause serious electrical shock or electrocution if not serviced properly. See your authorized dealer for service.

NOTE: When HID headlights are turned on, there is a blue hue to the lights. This diminishes and becomes more white after approximately 10 seconds, as the system charges.

1. Open the hood.

NOTE: Removal of the air cleaner filter housing may be necessary prior to replacing bulbs in the headlight assembly on the driver side of the vehicle.

2. Twist the appropriate bulb and socket assembly counter-clockwise, and then pull it out of the headlight assembly.

3. Pull the bulb out of the socket assembly.

4. Push the replacement bulb into the socket assembly.
5. Reinstall the bulb and socket assembly into the headlight assembly, and then turn it clockwise.

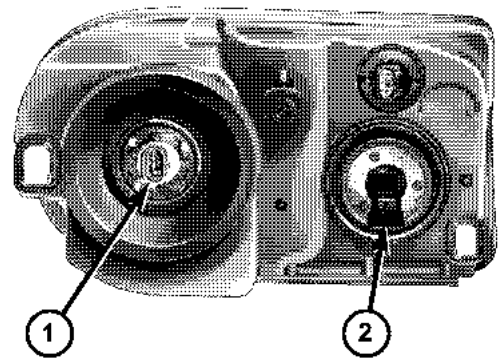

818db0f3

- 1 — Low Beam Headlight Bulb
2 — High Beam Headlight Bulb

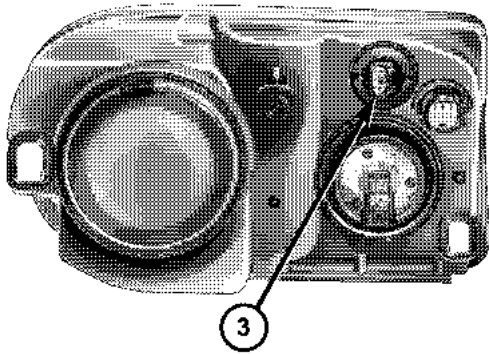

818db130

3 — Park/Turn Light Bulb

CAUTION!

Do not touch the new bulb with your fingers. Oil contamination will severely shorten bulb life. If the bulb comes in contact with an oily surface, clean the bulb with rubbing alcohol.

Tail/Stop, Tail, Turn Signal Light, and Backup Light

1. Open the Trunk.
2. Remove two fasteners from the back of the tail light assembly.

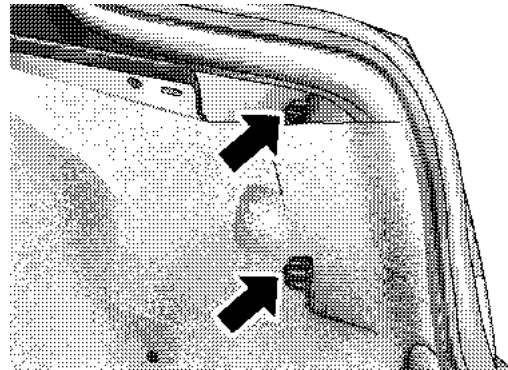

812c4b54

3. Pull back the trunk liner.
4. Remove the remaining fastener from the back of the tail light assembly.
5. Push the electrical connector locking tab to the side.

6. Disconnect the electrical connector.

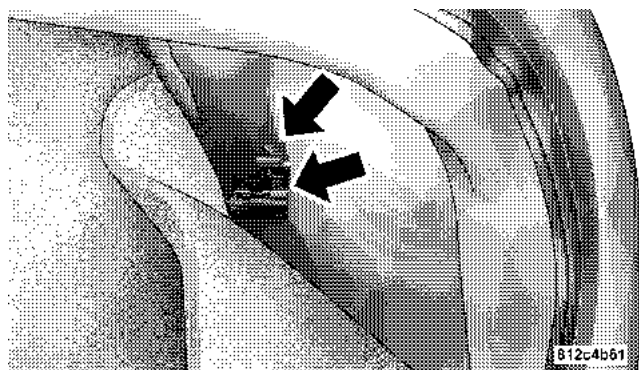

7. Pull the tail light assembly clear from the vehicle to access the bulbs. Turn bulb sockets counter-clockwise to remove.

8. Turn the appropriate bulb and socket assembly counter-clockwise to remove it from the tail light assembly.

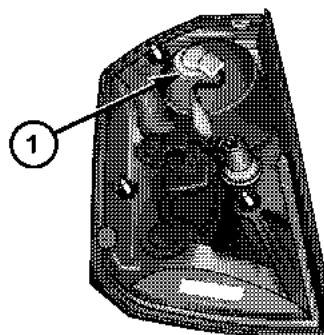

1 — Tail/Stop Light Bulb

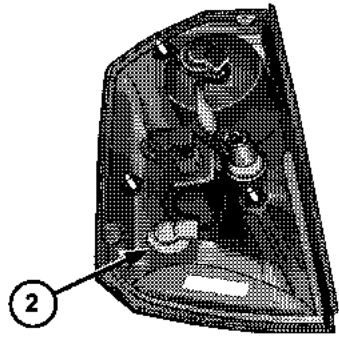

2 — Tail Light Bulb

818db1b4

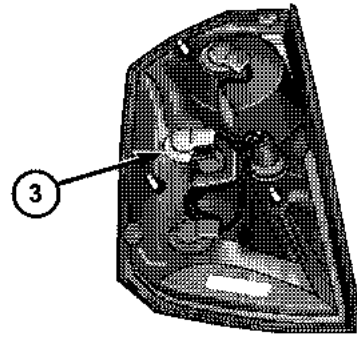

3 — Turn Signal Light Bulb

818db1b9

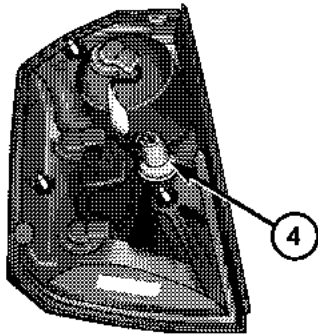

818db1c9

4 — Backup Light Bulb

9. Pull the bulb out of the socket assembly.
10. Push the replacement bulb into the socket assembly.
11. Reinstall the bulb and socket assembly into the tail light assembly, and then turn it clockwise.
12. Reinstall the tail light assembly, fasteners, electrical connector, and trunk liner.
13. Close the trunk.

License Light

1. Remove the screws securing the light to the rear fascia.
2. Remove the bulb and socket assembly.
3. Pull the bulb out of the socket assembly.

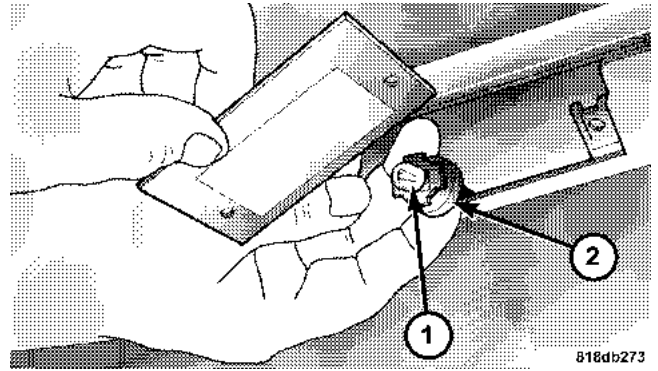

818db273

1 — License Light Bulb
2 — Socket

4. Push the replacement bulb into the socket assembly.
5. Reinstall the bulb and socket assembly.
6. Reattach the light to the rear fascia, and then install the screws.

FLUIDS AND CAPACITIES

| | U.S. | Metric |
|---|-----------------|------------------|
| Fuel (approximate) | | |
| 6.1 Liter Engine | 19 gal- lons | 72 liters |
| Engine Oil with Filter | | |
| 6.1 Liter Engine (SAE 0W-40) | 7 qts. | 6.6 liters |
| Cooling System * | | |
| 6.1 Liter Engine (Mopar® Antifreeze/Coolant 5 Year/ 100,000 Mile Formula) or equivalent. | 15.2 qts | 14.4 li- ters |
| * Includes heater and coolant recovery bottle filled to MAX level. | | |

FLUIDS, LUBRICANTS, AND GENUINE PARTS**Engine**

| Component | Fluids, Lubricants, and Genuine Parts |
|----------------------------|--|
| Engine Coolant | Mopar® Antifreeze/Coolant 5 Year/100,000 Mile Formula HOAT (Hybrid Organic Additive Technology) or equivalent |
| Engine Oil (6.1 Liter) | For best performance and maximum protection under all types of operating conditions, the manufacturer only recommends full synthetic engine oils that meet the American Petroleum Institute (API) categories of SM or SM/CF, and meet the requirements of DaimlerChrysler Material Standard MS-10725. The manufacturer recommends the use of a full synthetic engine oil, such as Mobil 1® SAE 0W-40 or equivalent. For additional information, refer to the "Engine Oil Selection" and "Engine Oil Viscosity (SAE Grade)" in the "Maintenance Procedures" section of this manual. |
| Oil Filter (6.1 Liter) | Mopar® 05281090 or equivalent. |
| Spark Plugs | Refer to the "Vehicle Emission Control Information" label in the engine compartment. |
| Fuel Selection (6.1 Liter) | Premium Unleaded 91 Octane Only or higher. |

Chassis

| Component | Fluids, Lubricants, and Genuine Parts |
|--------------------------|--|
| Automatic Transmission | Mopar® ATF+4 Automatic Transmission Fluid. |
| Brake Master Cylinder | Mopar® DOT 3, SAE J1703 should be used. If DOT 3, SAE J1703 brake fluid is not available, then DOT 4 is acceptable. Use only recommended brake fluids. |
| Power Steering Reservoir | Mopar® Power Steering Fluid + 4, Mopar® ATF+4 Automatic Transmission Fluid. |
| Rear Axle | API Certified GL-5 SAE 75W140 Synthetic Gear Lubricant or equivalent. |

MAINTENANCE SCHEDULES

CONTENTS

| | | | |
|---|-----|--------------------------|-----|
| ■ Emission Control System Maintenance | 318 | □ Schedule "B" | 321 |
| ■ Maintenance Schedules | 318 | □ Schedule "A" | 331 |

EMISSION CONTROL SYSTEM MAINTENANCE

The “Scheduled” maintenance services, listed in **bold type** must be done at the times or mileages specified to assure the continued proper functioning of the emission control system. These, and all other maintenance services included in this manual, should be done to provide best vehicle performance and reliability. More frequent maintenance may be needed for vehicles in severe operating conditions such as dusty areas and very short trip driving.

Inspection and service also should be done any time a malfunction is suspected.

NOTE: Maintenance, replacement, or repair of the emission control devices and systems on your vehicle may be performed by any automotive repair establishment or individual using any automotive part, which has been certified pursuant to U.S. EPA or, in the State of California, California Air Resources Board regulations.

MAINTENANCE SCHEDULES

There are two maintenance schedules that show the **required** service for your vehicle.

First is Schedule “**B.**” It is for vehicles that are operated under the conditions that are listed below and at the beginning of the schedule.

Change the automatic transmission fluid and filter every 60,000 miles (100 000 km) if the vehicle is usually operated under one or more of the conditions marked with an ◇.

- Day or night temperatures are below 32°F (0°C).
- Stop and go driving.
- Extensive engine idling.
- Driving in dusty conditions.
- Short trips of less than 10 miles (16 km).
- More than 50% of your driving is at sustained high speeds during hot weather, above 90°F (32°C).
- Trailer towing. ◇

- Taxi, police, or delivery service (commercial service). ◇
- Off-road or desert operation.

NOTE: If **ANY** of these apply to you, then change your engine oil every 3,000 miles (5 000 km) or 3 months, whichever comes first, and follow the maintenance recommendations in Schedule "B" in this section.

NOTE: If **ANY** of these apply to you, then flush and replace the engine coolant every 102,000 miles (170 000 km) or 60 months, whichever comes first, and follow the maintenance recommendations in Schedule "B" in this section.

NOTE: Most vehicles are operated under the conditions listed for Schedule "B."

Second is Schedule "A." It is for vehicles that are not operated under any of the conditions listed under Schedule "B."

Use the schedule that best describes your driving conditions. Where time and mileage are listed, follow the interval that occurs first.

NOTE: Under no circumstances should oil change intervals exceed 6,000 miles (10 000 km) or 6 months whichever comes first.

| |
|---|
| CAUTION! |
| Failure to perform the required maintenance items may result in damage to the vehicle. |

At Each Stop for Fuel

- Check the engine oil level about 5 minutes after a fully warmed engine is shut off. Checking the oil level while the vehicle is on level ground will improve the accuracy of the oil level reading. Add oil only when the level is at or below the ADD or MIN mark.
- Check the windshield washer solvent and add if required.

320 MAINTENANCE SCHEDULES

Once a Month

- Check tire pressure and look for unusual wear or damage.
- Inspect the battery, and clean, and tighten the terminals as required.
- Check the fluid levels of coolant reservoir and brake master cylinder, and add as needed.
- Check all lights and all other electrical items for correct operation.
- Check rubber seals on each side of the radiator for proper fit.

At Each Oil Change

- Change the engine oil filter.
- Inspect the exhaust system.
- Inspect the brake hoses.
- Inspect the CV joints and front and rear suspension components.
- Check the coolant level, hoses, and clamps.

SCHEDULE "B"

Follow Schedule "B" if you usually operate your vehicle under one or more of the following conditions.

Change the automatic transmission fluid and filter every 60,000 miles (100 000 km) if the vehicle is usually operated under one or more of the conditions marked with an ◇.

- Day or night temperatures are below 32°F (0°C).
- Stop and go driving.
- Extensive engine idling.
- Driving in dusty conditions.
- Short trips of less than 10 miles (16 km).
- More than 50% of your driving is at sustained high speeds during hot weather, above 90°F (32°C).

- Trailer towing. ◇
- Taxi, police or delivery service (commercial services). ◇
- Off-road or desert operation.

NOTE: If **ANY** of these apply to you, then change your engine oil every 3,000 miles (5 000 km) or 3 months, whichever comes first, and follow the maintenance recommendations in Schedule "B" in this section.

NOTE: If **ANY** of these apply to you, then flush and replace the engine coolant every 102,000 miles (170 000 km) or 60 months, whichever comes first, and follow the maintenance recommendations in Schedule "B" in this section.

322 SCHEDULE "B"

| Miles (Kilometers) | 3,000 (5 000) | 6,000 (10 000) | 9,000 (15 000) | 12,000 (20 000) | 15,000 (25 000) | 18,000 (30 000) |
|---|------------------|-------------------|-------------------|--------------------|--------------------|--------------------|
| Change engine oil and engine oil filter, if not replaced at 3 months. | X | X | X | X | X | X |
| Inspect the air cleaner filter and replace if required.* | X | X | X | X | | X |
| Replace the air cleaner filter . | | | | | X* | |
| Inspect the front and rear brake linings and rotors. | | | | X | | |
| Replace the air conditioning filter. | | | | X | | |
| Rotate the tires. | | X | | X | | X |

| Miles (Kilometers) | 21,000 (35 000) | 24,000 (40 000) | 27,000 (45 000) | 30,000 (50 000) | 33,000 (55 000) | 36,000 (60 000) |
|---|--------------------|--------------------|--------------------|--------------------|--------------------|--------------------|
| Change engine oil and engine oil filter, if not replaced at 3 months. | X | X | X | X | X | X |
| Inspect the air cleaner filter and replace if required.* | X | X | X | | X | X |
| Replace the air cleaner filter . | | | | X | | |
| Inspect the front and rear brake linings and rotors. | | X | | | | X |
| Check and replace, if necessary, the PCV valve . * | | | | X | | |
| Replace the air conditioning filter. | | X | | | | X |
| Rotate the tires. | | X | | X | | X |

324 SCHEDULE "B"

| Miles (Kilometers) | 39,000 (65 000) | 42,000 (70 000) | 45,000 (75 000) | 48,000 (80 000) | 51,000 (85 000) | 54,000 (90 000) |
|---|--------------------|--------------------|--------------------|--------------------|--------------------|--------------------|
| Change engine oil and engine oil filter, if not replaced at 3 months. | X | X | X | X | X | X |
| Inspect the air cleaner filter and replace if required.* | X | X | | X | X | X |
| Replace the air cleaner filter . | | | X* | | | |
| Inspect the front and rear brake linings and rotors. | | | | X | | |
| Change the rear axle fluid. | | | | X | | |
| Replace the air conditioning filter. | | | | X | | |
| Rotate the tires. | | X | | X | | X |

| Miles (Kilometers) | 57,000 (95 000) | 60,000 (100 000) | 63,000 (105 000) | 66,000 (110 000) | 69,000 (115 000) | 72,000 (120 000) |
|--|--------------------|---------------------|---------------------|---------------------|---------------------|---------------------|
| Change engine oil and engine oil filter, if not replaced at 3 months. | X | X | X | X | X | X |
| Inspect the air cleaner filter and replace if required.* | X | | X | X | X | X |
| Replace the air cleaner filter . | | X | | | | |
| Inspect the front and rear brake linings and rotors. | | X | | | | X |
| Check and Inspect the accessory drive belt and tensioner. Replace if required. | | | | | | X |
| Check and replace, if necessary, the PCV valve . * ‡ | | X | | | | |
| Change the power steering fluid | | X | | | | |
| Change the automatic transmission fluid and filter. | | X | | | | |
| Replace the air conditioning filter. | | X | | | | X |
| Flush and replace engine coolant at 60 months if not done at 102,000 miles. | | X | | | | |
| Rotate the tires. | | X | | X | | X |

326 SCHEDULE "B"

| Miles (Kilometers) | 75,000 (125 000) | 78,000 (130 000) | 81,000 (135 000) | 84,000 (140 000) | 87,000 (145 000) | 90,000 (150 000) |
|---|---------------------|---------------------|---------------------|---------------------|---------------------|---------------------|
| Change engine oil and engine oil filter, if not replaced at 3 months. | X | X | X | X | X | X |
| Inspect the air cleaner filter and replace if required.* | | X | X | X | X | |
| Replace the air cleaner filter . | X* | | | | | X |
| Inspect the front and rear brake linings and rotors. | | | | X | | |
| Check and replace, if necessary, the PCV valve . * ‡ | | | | | | X |
| Replace the air conditioning filter. | | | | X | | |
| Rotate the tires. | | X | | X | | X |

| Miles (Kilometers) | 93,000 (155 000) | 96,000 (160 000) | 99,000 (165 000) | 102,000 (170 000) | 105,000 (175 000) |
|--|---------------------|---------------------|---------------------|----------------------|----------------------|
| Change engine oil and engine oil filter, if not replaced at 3 months. | X | X | X | X | X |
| Inspect the air cleaner filter and replace if required.* | X | X | X | X | |
| Replace the air cleaner filter . | | | | | X* |
| Inspect the front and rear brake linings and rotors. | | X | | | |
| Replace the spark plugs . | | | X | | |
| Check and Inspect the accessory drive belt and tensioner. Replace if required. | | | | X | |
| Change the rear axle fluid. | | X | | | |
| Replace the air conditioning filter. | | X | | | |
| Flush and replace engine coolant at 102,000 miles if not done at 60 months. | | | | X | |
| Rotate the tires. | | X | | X | |

328 SCHEDULE "B"

| Miles (Kilometers) | 108,000 (180 000) | 111,000 (185 000) | 114,000 (190 000) | 117,000 (195 000) | 120,000 (200 000) |
|---|----------------------|----------------------|----------------------|----------------------|----------------------|
| Change engine oil and engine oil filter, if not replaced at 3 months. | X | X | X | X | X |
| Inspect the air cleaner filter and replace if required.* | X | X | X | X | |
| Replace the air cleaner filter . | | | | | X |
| Inspect the front and rear brake linings and rotors. | X | | | | X |
| Check and replace, if necessary, the PCV valve . * | | | | | X |
| Change the automatic transmission fluid and filter. | | | | | X |
| Replace the air conditioning filter. | X | | | | X |
| Flush and replace the engine coolant at 120 months, if not replaced at 102,000 miles. | | | | | X |
| Rotate the tires. | X | | X | | X |

| Miles (Kilometers) | 123,000 (205 000) | 126,000 (210 000) | 129,000 (215 000) | 132,000 (220 000) | 135,000 (225 000) |
|--|----------------------|----------------------|----------------------|----------------------|----------------------|
| Change engine oil and engine oil filter, if not replaced at 3 months. | X | X | X | X | X |
| Inspect the air cleaner filter and replace if required.* | X | X | X | X | |
| Replace the air cleaner filter . | | | | | X* |
| Inspect the front and rear brake linings and rotors. | | | | X | |
| Check and Inspect the accessory drive belt and tensioner. Replace if required. | | | | X | |
| Replace the air conditioning filter. | | | | X | |
| Rotate the tires. | | X | | X | |

330 SCHEDULE "B"

| Miles (Kilometers) | 138,000 (230 000) | 141,000 (235 000) | 144,000 (240 000) | 147,000 (245 000) | 150,000 (250 000) |
|---|----------------------|----------------------|----------------------|----------------------|----------------------|
| Change engine oil and engine oil filter, if not replaced at 3 months. | X | X | X | X | X |
| Inspect the air cleaner filter and replace if required.* | X | X | X | X | |
| Replace the air cleaner filter . | | | | | X |
| Inspect the front and rear brake linings and rotors. | | | X | | |
| Change the rear axle fluid. | | | X | | |
| Replace the air conditioning filter. | | | X | | |
| Rotate the tires. | X | | X | | X |

* This maintenance is recommended by the manufacture to the owner but is not required to maintain the emissions warranty.

Inspection and service should also be performed anytime a malfunction is observed or suspected. Retain all receipts.

‡ This maintenance is not required if previously replaced.

SCHEDULE "A"

| Miles (Kilometers) [Months] | 6,000 (10 000) [6] | 12,000 (20 000) [12] | 18,000 (30 000) [18] | 24,000 (40 000) [24] | 30,000 (50 000) [30] | 36,000 (60 000) [36] |
|---|--------------------------|----------------------------|----------------------------|----------------------------|----------------------------|----------------------------|
| Change engine oil and engine oil filter. | X | X | X | X | X | X |
| Inspect the air cleaner filter and replace if required.* | X | X | X | X | | X |
| Replace the air cleaner filter . | | | | | X | |
| Inspect the front and rear brake linings and rotors. | | | X | | | X |
| Replace the air conditioning filter. | | X | | X | | X |
| Rotate the tires. | X | X | X | X | X | X |

332 SCHEDULE "A"

| Miles (Kilometers) | 42,000 (70 000) | 48,000 (80 000) | 54,000 (90 000) | 60,000 (100 000) | 66,000 (110 000) | 72,000 (120 000) |
|--|--------------------|--------------------|--------------------|---------------------|---------------------|---------------------|
| [Months] | [42] | [48] | [54] | [60] | [66] | [72] |
| Change engine oil and engine oil filter. | X | X | X | X | X | X |
| Inspect the air cleaner filter and replace if required.* | X | X | X | | X | X |
| Replace the air cleaner filter . | | | | X | | |
| Inspect the front and rear brake linings and rotors. | | | X | | | X |
| Check and Inspect the accessory drive belt and tensioner. Replace if required. | | | | | | X |
| Flush and replace engine coolant at 60 months if not done at 102,000 miles. | | | | X | | |
| Check and replace, if necessary, the PCV valve . * | | | | X | | |
| Replace the air conditioning filter. | | X | | X | | X |
| Rotate the tires. | X | X | X | X | X | X |

| Miles (Kilometers) | 78,000 (130 000) | 84,000 (140 000) | 90,000 (150 000) | 96,000 (160 000) | 102,000 (170 000) |
|---|---------------------|---------------------|---------------------|---------------------|----------------------|
| [Months] | [78] | [84] | [90] | [96] | [102] |
| Change engine oil and engine oil filter. | X | X | X | X | X |
| Inspect the air cleaner filter and replace if required.* | X | X | | X | X |
| Replace the air cleaner filter . | | | X | | |
| Inspect the front and rear brake linings and rotors. | | | X | | |
| Check and Inspect the accessory drive belt and tensioner. Replace if required. | | | | | X |
| Replace the spark plugs . | | | | X | |
| Check and replace, if necessary, the PCV valve . *‡ | | | X | | |
| Flush and replace the engine coolant at 102,000 miles if not done at 60 months. | | | | | X |
| Replace the air conditioning filter. | | X | | X | |
| Rotate the tires. | X | X | X | X | X |

334 SCHEDULE "A"

| Miles (Kilometers) | 108,000 (180 000) | 114,000 (190 000) | 120,000 (200 000) | 126,000 (210 000) | 132,000 (220 000) |
|---|----------------------|----------------------|----------------------|----------------------|----------------------|
| [Months] | [108] | [114] | [120] | [126] | [132] |
| Change engine oil and engine oil filter. | X | X | X | X | X |
| Inspect the air cleaner filter and replace if required.* | X | X | | X | X |
| Replace the air cleaner filter . | | | X | | |
| Inspect the front and rear brake linings and rotors. | X | | | X | |
| Check and Inspect the accessory drive belt and tensioner. Replace if required. | | | | | X |
| Check and replace, if necessary, the PCV valve . * | | | X | | |
| Replace the air conditioning filter. | X | | X | | X |
| Flush and replace the engine coolant at 120 months, if not replaced at 102,000 miles. | | | X | | |
| Rotate the tires. | X | X | X | X | X |

| Miles (Kilometers) [Months] | 138,000 (230 000) [138] | 144,000 (240 000) [144] | 150,000 (250 000) [150] |
|---|-------------------------------|-------------------------------|-------------------------------|
| Change engine oil and engine oil filter. | X | X | X |
| Inspect the air cleaner filter and replace if required.* | X | X | |
| Replace the air cleaner filter . | | | X |
| Inspect the front and rear brake linings and rotors. | | X | |
| Replace the air conditioning filter. | | X | |
| Rotate the tires. | X | X | X |

* This maintenance is recommended by the manufacturer to the owner but is not required to maintain the emissions warranty.

‡ This maintenance is not required if previously replaced.

Inspection and service should also be performed anytime a malfunction is observed or suspected. Retain all receipts.

| |
|--|
| WARNING! |
| You can be badly injured working on or around a motor vehicle. Only do service work for which you have the knowledge and the right equipment. If you have any doubt about your ability to perform a service job, take your vehicle to a competent mechanic. |

IF YOU NEED CONSUMER ASSISTANCE

CONTENTS

| | | | |
|--|-----|--|-----|
| ■ Suggestions For Obtaining Service For Your Vehicle | 338 | ■ Reporting Safety Defects | 341 |
| □ Prepare For The Appointment | 338 | □ In Canada | 341 |
| □ Prepare A List | 338 | ■ Publication Order Forms | 341 |
| □ Be Reasonable With Requests | 338 | ■ Department Of Transportation Uniform Tire Quality Grades | 343 |
| ■ If You Need Assistance | 338 | □ Treadwear | 343 |
| ■ Warranty Information (U.S. Vehicles Only) | 340 | □ Traction Grades | 343 |
| ■ Mopar® Parts | 340 | □ Temperature Grades | 344 |

SUGGESTIONS FOR OBTAINING SERVICE FOR YOUR VEHICLE**Prepare For The Appointment**

If you're having warranty work done, be sure to have the right papers with you. Take your warranty folder. All work to be performed may not be covered by the warranty, discuss additional charges with the service manager. Keep a maintenance log of your vehicle's service history. This can often provide a clue to the current problem.

Prepare A List

Make a written list of your vehicle's problems or the specific work you want done. If you've had an accident, or work done that is not on your maintenance log, let the service advisor know.

Be Reasonable With Requests

If you list a number of items, and you must have your vehicle by the end of the day, discuss the situation with the service advisor and list the items in order of priority. At many dealers you may obtain a rental vehicle at a

minimal daily charge. If you need a rental, it is advisable to make these arrangements when you call for an appointment.

IF YOU NEED ASSISTANCE

The manufacturer and its dealers are vitally interested in your satisfaction. We want you to be happy with our products and services.

Warranty service must be done by an authorized Chrysler, Dodge, or Jeep dealer. We strongly recommend that you take your vehicle to your selling dealer. They know you and your vehicle best, and are most concerned that you get prompt and high quality service. The manufacturer's dealers have the facilities, factory-trained technicians, special tools, and the latest information to assure your vehicle is fixed correctly and in a timely manner.

This is why you should always talk to your dealer's service manager first. Most matters can be resolved with this process.

- If for some reason you are still not satisfied, talk to the general manager or owner of the dealership. They want to know if you need assistance.
- If your dealership is unable to resolve the concern, you may contact the Manufacturer's Customer Center.

Any communication to the Manufacturer's Customer Center should include the following information:

- Owner's name and address
- Owner's telephone number (home and office)
- Dealership name
- Vehicle identification number
- Vehicle delivery date and mileage

DaimlerChrysler Motors Corporation Customer Center

P.O. Box 21-8004
Auburn Hills, MI 48321-8004
Phone: (800) 992-1997

DaimlerChrysler Canada Inc. Customer Center

P.O. Box 1621
Windsor, Ontario N9A 4H6
Phone —(800) 465-2001

In Mexico contact:

Av. Prolongacion Paseo de la Reforma, 1240
Sante Fe C.P. 05109
Mexico, D. F.
In Mexico (915) 729-1248 or 729-1240
Outside Mexico (525) 729-1248 or 729-1240

Customer Assistance For The Hearing Or Speech Impaired (TDD/TTY)

To assist customers who have hearing difficulties, the manufacturer has installed special TDD (Telecommunication Devices for the Deaf) equipment at its Customer Center. Any hearing or speech impaired customer who has access to a TDD or a conventional teletypewriter (TTY) in the United States can communicate with the manufacturer by dialing 1-800-380-CHRY.

Service Contract

You may have purchased a service contract for your vehicle to help protect you from the high cost of unexpected repairs after your manufacturer's new vehicle limited warranty expires. The manufacturer stands behind only the manufacturer's Service Contracts. If you purchased a manufacturer's Service Contract, you will receive Plan Provisions and an Owner Identification Card in the mail within three weeks of your vehicle delivery date. If you have any questions about your service contract, call the manufacturer's Service Contract National Customer Hotline at 1-800-521-9922.

The manufacturer will not stand behind any service contract that is not the manufacturer's Service Contract. It is not responsible for any service contract other than the manufacturer's Service Contract. If you purchased a service contract that is not a manufacturer's Service Contract, and you require service after your manufacturer's new vehicle limited warranty expires, please refer to your contract documents, and contact the person listed in those documents.

We appreciate that you have made a major investment when you purchased your new vehicle. Your dealer has also made a major investment in facilities, tools, and training to assure that you are absolutely delighted with your ownership experience. You'll be pleased with their sincere efforts to resolve any warranty issues or related concerns.

WARRANTY INFORMATION (U.S. Vehicles Only)

See the Warranty Information Booklet for the terms and provisions of DaimlerChrysler's warranties applicable to this vehicle.

MOPAR® PARTS

Mopar® fluids, lubricants, parts, and accessories are available from your dealer. They will help you keep your vehicle operating at its best.

REPORTING SAFETY DEFECTS

In the 50 United States and Washington D.C.: If you believe that your vehicle has a defect, which could cause a crash or cause injury or death, you should immediately inform the National Highway Traffic Safety Administration (NHTSA) in addition to notifying the manufacturer.

If NHTSA receives similar complaints, it may open an investigation, and if it finds that a safety defect exists in a group of vehicles, it may order a recall and remedy campaign. However, NHTSA cannot become involved in individual problems between you, your dealer, and the manufacturer.

To contact NHTSA, you may either call the Auto Safety Hotline toll free at 1-888-327-4236 (TTY: 1-800-424-9153), or go to <http://www.NHTSA.gov>. or write to: NHTSA, U.S. Dept. of Transportation, Washington DC 20590. You can also obtain other information about motor vehicle safety from the Hotline.

In Canada:

If you believe that your vehicle has a safety defect, you should contact the Customer Service Department immediately. Canadian customers who wish to report a safety defect to the Canadian government should write to Transport Canada, Motor Vehicle Defect Investigations and Recalls, 2780 Sheffield Road, Ottawa, Ontario K1B 3V9.

PUBLICATION ORDER FORMS

To order the following manuals, you may use either the website or the phone numbers listed below. Visa, Mastercard, American Express, and Discover orders are accepted. If you prefer mailing your payment, please call for an order form.

NOTE: A street address is required when ordering manuals. (No P.O. Boxes).

- *Service Manuals.*

These comprehensive service manuals provide the information that students and professional technicians need in diagnosing/troubleshooting, problem solving, maintaining, servicing, and repairing DaimlerChrysler Corporation vehicles. A complete working knowledge of the vehicle, system, and/or components is written in straightforward language with illustrations, diagrams, and charts.

- *Diagnostic Procedure Manuals.*

Filled with diagrams, charts and detailed illustrations, these practical manuals make it easy for students and technicians to find and fix problems on computer-controlled vehicle systems and features. They show exactly how to find and correct problems the first time, using step-by-step troubleshooting and driveability procedures, proven diagnostic tests and a complete list of all tools and equipment.

- *Owner's Manuals.*

These manuals have been prepared with the assistance of service and engineering specialists to acquaint you with specific Chrysler group vehicles. Included are starting, operating, emergency and maintenance procedures as well as specifications, capabilities and safety tips.

Call Toll Free at:

- **1-800-890-4038 (U.S.)**
- **1-800-387-1143 (Canada)**

Or

Visit us on the World Wide Web at:

- **www.techauthority.daimlerchrysler.com**
- **www.daimlerchrysler.ca/manuals**

DEPARTMENT OF TRANSPORTATION UNIFORM TIRE QUALITY GRADES

The following describes the tire grading categories established by the National Highway Traffic Safety Administration. The specific grade rating assigned by the tire's manufacturer in each category is shown on the sidewall of the tires on your car.

All Passenger Car Tires Must Conform to Federal Safety Requirements in Addition to These Grades.

Treadwear

The treadwear grade is a comparative rating based on the wear rate of the tire when tested under controlled conditions on a specified government test course. For example, a tire graded 150 would wear one and a half (1 1/2) times as well on the government course as a tire graded 100. The relative performance of tires depends upon the actual conditions of their use, however, and may depart significantly from the norm due to variations in driving habits, service practices and differences in road characteristics and climate.

Traction Grades

The traction grades, from highest to lowest, are AA, A, B, and C. Those grades represent the tire's ability to stop on wet pavement as measured under controlled conditions on specified government test surfaces of asphalt and concrete. A tire marked C may have poor traction performance.

WARNING!

The traction grade assigned to this tire is based on straight-ahead braking traction tests, and does not include acceleration, cornering, hydroplaning, or peak traction characteristics.

Temperature Grades

The temperature grades are A (the highest), B, and C, representing the tire's resistance to the generation of heat and its ability to dissipate heat when tested under controlled conditions on a specified indoor laboratory test wheel. Sustained high temperature can cause the material of the tire to degenerate and reduce tire life, and excessive temperature can lead to sudden tire failure. The grade C corresponds to a level of performance which all passenger car tires must meet under the Federal Motor Vehicle Safety Standard No. 109. Grades B and A represent higher levels of performance on the laboratory test wheel than the minimum required by law.

WARNING!

The temperature grade for this tire is established for a tire that is properly inflated and not overloaded. Excessive speed, under inflation, or excessive loading, either separately or in combination, can cause heat buildup and possible tire failure.

INDEX

- ABS (Anti-Lock Brake System) 211
- Adding Engine Coolant (Antifreeze) 289
- Adding Fuel 249
- Adding Washer Fluid 104,106,285
- Adjustable Pedals 108
- Air Cleaner, Engine
(Engine Air Cleaner Filter) 279
- Air Conditioner Maintenance 282
- Air Conditioning Filter 189,283
- Air Conditioning, Operating Tips 190
- Air Conditioning Refrigerant 282,283
- Air Conditioning System 183,282
- Air Pressure, Tires 141,230
- Airbag 38
- Airbag Deployment 42,44
- Airbag Light 43,46,58,137
- Airbag Maintenance 45
- Airbag, Side 43
- Airbag, Window (Side Curtain) 38,43
- Alarm (Security Alarm) 140
- Alarm System (Security Alarm) 15
- Alignment and Balance 235
- Alterations/Modifications, Vehicle 7
- Antenna, Satellite Radio 179
- Antifreeze (Engine Coolant) 288,289,313
Disposal 290
- Anti-Lock Brake System (ABS) 211,214
- Anti-Lock Warning Light 137,213
- Anti-Theft Security Alarm (Theft Alarm) 15
- Anti-Theft System 140
- Appearance Care 296
- Auto Down Power Windows 25
- Auto Up Power Windows 26
- Automatic Dimming Mirror 63
- Automatic Door Locks 22,23
- Automatic Headlights 95
- Automatic Temperature Control (ATC) 183
- Automatic Transaxle
Special Additives 295
- Automatic Transmission 203,294,295
Adding Fluid 295,315
- Autostick 207
- Fluid and Filter Changes 295
- Fluid Change 295
- Fluid Level Check 294
- Fluid Type 315

- Shifting 203
- Special Additives 295
- Autostick 205,207

- Ball Joints 284
- Battery 281
 - Emergency Starting 262
 - Jump Starting 262
 - Keyless Transmitter Replacement (RKE) 19
 - Location 263,281
- Bearings 295
- Belts, Drive 278
- Belts, Seat 30
- Body Mechanism Lubrication 284
- B-Pillar Location 225
- Brake Assist System 215
- Brake Control System, Electronic 214
- Brake, Parking 210
- Brake System 211,292
 - Anti-Lock (ABS) 211,214
 - Fluid Check 293,315
 - Hoses 292
 - Master Cylinder 293
- Parking 210
 - Warning Light 138,211
- Brakes 211
- Brake/Transmission Interlock 202
- Break-In Recommendations, New Vehicle 55
- Bulb Replacement 307
- Bulbs, Light 307

- Calibration, Compass 149
- Capacities, Fluid 313
- Caps, Filler
 - Fuel 249
 - Oil (Engine) 277
 - Radiator (Coolant Pressure) 289
- Car Washes 296
- Carbon Monoxide Warning 56,248
- Cassette Tape and Player Maintenance 181
- Catalytic Converter 279
- CD (Compact Disc) Player 159
- Cellular Phone 66
- Chains, Tire 235
- Chart, Tire Sizing 222

- Check Engine Light
(Malfunction Indicator Light) 273
- Child Restraint 47,49,52,53
- Child Restraint Tether Anchors 50,52
- Child Safety Locks 23
- Clean Air Gasoline 246
- Cleaning
Wheels 297
- Climate Control 183
- Clock 157,160,171
- Compact Disc (CD) Maintenance 182
- Compass 149
- Compass Calibration 149
- Compass Variance 149
- Computer, Trip/Travel 147
- Console 127
- Console, Floor 127
- Console, Overhead 115
- Contract, Service 340
- Coolant Pressure Cap (Radiator Cap) 289
- Cooling System 287
Adding Coolant (Antifreeze) 289
Coolant Capacity 313
Coolant Level 287,290
Disposal of Used Coolant 290
Drain, Flush, and Refill 287
Inspection 290
Points to Remember 290
Pressure Cap 289
Radiator Cap 289
Selection of Coolant (Antifreeze) 288,313,314
- Cruise Control (Speed Control) 109
- Cruise Light 136
- Cup Holder 126,299
- Customer Assistance 338
- Data Recorder, Event 46
- Daytime Running Lights 98
- Dealer Service 274
- Defroster, Rear Window 191
- Defroster, Windshield 58,187
- Delay (Intermittent) Wipers 101
- Diagnostic System, Onboard 272
- Dimmer Switch, Headlight 99
- Disposal
Antifreeze (Engine Coolant) 290

- Door Locks 21
- Door Locks, Automatic 22
- Door Opener, Garage 116
- Drive Belts 278
- Driving
 - On Slippery Surfaces 209
- DVD Player (Video Entertainment System) 174

- Electric Remote Mirrors 64
- Electrical Power Outlets 124
- Electronic Brake Control System 214
- Electronic Speed Control (Cruise Control) 109
- Electronic Stability Program (ESP) 216
- Electronic Throttle Control Warning Light 141
- Electronic Vehicle Information Center (EVIC) 144
- Emergency, In Case of
 - Freeing Vehicle When Stuck 265
 - Hazard Warning Flasher 256
 - Jump Starting 262
 - Overheating 256
 - Towing 266
- Emission Control System Maintenance 273,318
- Engine 271

- Air Cleaner 279
- Block Heater 199
- Break-In Recommendations 55
- Checking Oil Level 275
- Compartment 271
- Coolant (Antifreeze) 287,314
- Cooling 287
- Exhaust Gas Caution 56,248
- Fails to Start 197
- Flooded, Starting 197
- Fuel Requirements 246,313
- Oil 275,313,314
- Oil Change Interval 276
- Oil Filler Cap 277
- Oil Selection 277,313
- Overheating 256
- Temperature Gauge 139
- Enhanced Accident Response Feature 45
- Ethanol 247
- Event Data Recorder 46
- Exhaust Gas Caution 56,57,248,286
- Exhaust System 56,286
- Exterior Folding Mirrors 64

- Exterior Lighting 95
- Filters
- Air Cleaner 279
 - Air Conditioning 189,283
 - Engine Fuel 279
 - Engine Oil 278,314
 - Engine Oil Disposal 278
- Flashers
- Hazard Warning 256
 - Turn Signal 98,136
- Flash-To-Pass 99
- Flooded Engine Starting 197
- Floor Console 127
- Fluid Capacities 313
- Fluid Leaks 58
- Fluid Level Checks
- Brake 293
 - Cooling System 287
 - Engine Oil 275
 - Power Steering 284
- Fluids 314
- Fluids, Lubricants and Genuine Parts 314
- Fog Lights 98,136
- Folding Rear Seat 89
- Freeing A Stuck Vehicle 265
- Front Suspension Ball Joints 284
- Front Wheel Bearings 295
- Fuel 246
- Adding 249
 - Clean Air 246
 - Ethanol 247
 - Filler Cap (Gas Cap) 249
 - Filter 279
 - Gasoline 246
 - Gauge 141
 - Hoses 292
 - Methanol 247
 - Octane Rating 246,314
 - Requirements 246,313
 - Tank Capacity 313
- Fuel System Caution 250
- Fueling 249
- Fuses 300
- Garage Door Opener (HomeLink®) 116

- Gas Cap (Fuel Filler Cap) 249,272
- Gasoline, Clean Air 246
- Gasoline (Fuel) 246
- Gasoline, Reformulated 246
- Gauges
- Coolant Temperature 139
 - Fuel 141
 - Speedometer 136
 - Tachometer 137
- General Information 15,20,245
- Glass Cleaning 298
- Gross Axle Weight Rating 252
- Gross Vehicle Weight Rating 252
- Ground Clearance 254
- GVWR 252
- Hands-Free Phone (UConnect™) 66
- Hazard Warning Flasher 256
- Head Restraints 87
- Headlight Washers 105,285
- Headlights 307
- Cleaning 298
 - High Beam 99
 - High Beam/Low Beam Select Switch 99
 - Lights On Reminder 98
 - On With Wipers 96,102
 - Passing 99
 - Switch 95
 - Time Delay 97
 - Washers 105,285
- Heated Mirrors 65
- Heated Seats 87
- Heater, Engine Block 199
- High Beam/Low Beam Select (Dimmer) Switch 99
- Holder, Cup 126
- HomeLink®
- (Garage Door Opener) Transmitter 116
- Hood Release 93
- Hoses 291,292
- Ignition 11
- Key 11
- Ignition Key Removal 11
- Illuminated Entry 17
- Immobilizer (Sentry Key) 12

- Infant Restraint 47,48
Inflation Pressure Tires 141
Information Center, Vehicle 144
Instrument Cluster 135,136
Instrument Panel and Controls 134
Instrument Panel Lens Cleaning 299
Interior Appearance Care 298
Interior Fuses 300
Interior Lights 100
Intermittent Wipers (Delay Wipers) 101
Introduction 4
- Jump Starting 262
- Key, Programming 14
Key, Replacement 13
Key, Sentry (Immobilizer) 12
Key-In Reminder 12
Keyless Entry System 17
Keys 11
Knee Bolster 38
- Lane Change and Turn Signals 98
- Lap/Shoulder Belts 30
- LATCH
(Lower Anchors and Tether for CHildren) 50,52
Latch Plate 31
Latches 58
Hood 93
Lead Free Gasoline 246
Life of Tires 233
- Lights 58,95
Airbag 43,46,58,137
Anti-Lock 137,213
Automatic Headlights 95
Brake Assist Warning 219
Brake Warning 138,211
Bulb Replacement 307
Courtesy/Reading 99,115
Cruise 136
Daytime Running 98
Dimmer Switch, Headlight 98,99
Electronic Stability Program
(ESP) Indicator 219
Electronic Throttle Control Warning 141
Engine Temperature Warning 137

| | | | |
|--------------------------------------|---------|--|---------|
| Fog | 98,136 | Tire Pressure Monitoring (TPMS) | 141,239 |
| Hazard Warning Flasher | 256 | Traction Control | 219 |
| Headlight Switch | 95 | Turn Signal | 98,136 |
| Headlights | 95,307 | Vanity Mirror | 65 |
| Headlights On With Wipers | 96,102 | Voltage | 142 |
| High Beam | 99,140 | Warning (Instrument Cluster Description) | 136 |
| High Beam Indicator | 140 | Load Leveling System | 129 |
| Illuminated Entry | 17 | Loading Vehicle | 252,253 |
| Instrument Cluster | 95,136 | Capacities | 253 |
| Interior | 100,115 | Tires | 225 |
| License | 312 | Locks | 21 |
| Lights On Reminder | 98 | Auto Unlock | 23 |
| Low Fuel | 136 | Child Protection | 23 |
| Low Tire | 141 | Door | 21 |
| Malfunction Indicator (Check Engine) | 143 | Power Door | 21 |
| Oil Pressure | 143 | Low Tire Pressure System | 239 |
| Passing | 99 | Lower Anchors and Tether for | |
| Reading | 115 | CHildren (LATCH) | 50,52 |
| Seat Belt Reminder | 140 | Lubrication, Body | 284 |
| Service | 307 | Lumbar Support | 87 |
| Service Engine Soon | | Maintenance Free Battery | 281 |
| (Malfunction Indicator) | 143 | Maintenance Procedures | 275 |
| SmartBeams | 96 | | |

| | | | |
|---|---------|---|---------|
| Maintenance Schedule | 318 | Navigation Radio | 170 |
| Schedule "A" | 331 | Navigation System | 170 |
| Schedule "B" | 321 | New Vehicle Break-In Period | 55 |
| Malfunction Indicator Light (Check Engine) | 143,273 | Occupant Restraints | 30 |
| Manual, Service | 341 | Octane Rating, Gasoline (Fuel) | 246 |
| Memory Feature (Memory Seat) | 90 | Odometer | 140 |
| Memory Seat | 90 | Trip | 140 |
| Memory Seats and Radio | 90 | Oil, Engine | 275,314 |
| Methanol | 247 | Capacity | 313 |
| Mini-Trip Computer | 147 | Change Interval | 276 |
| Mirrors | 63 | Checking | 275 |
| Automatic Dimming | 63 | Dipstick | 275 |
| Electric Remote | 64 | Disposal | 278 |
| Exterior Folding | 64 | Filter | 278,314 |
| Heated | 65 | Filter Disposal | 278 |
| Outside | 63 | Materials Added to | 277 |
| Vanity | 65 | Recommendation | 277,313 |
| Modifications/Alterations, Vehicle | 7 | Viscosity | 277,313 |
| Monitor, Tire Pressure System | 239 | Onboard Diagnostic System | 272,273 |
| Mopar Parts | 274,340 | Opener, Garage Door (HomeLink®) | 116 |
| MTBE/ETBE | 247 | Operating Precautions | 272 |
| Multi-Function Control Lever | 98 | Outside Rearview Mirrors | 63 |

| | | | |
|---------------------------------------|---------|-------------------------------------|-------------|
| Overhead Console | 115 | Steering, Checking | 284 |
| Overheating, Engine | 256 | Sunroof | 121 |
| Owner's Manual (Operator Manual) | 341 | Tilt/Telescoping Steering Column | 107 |
| Panic Alarm | 19 | Windows | 25 |
| Park Assist System, Rear | 112 | Pregnant Women and Seat Belts | 37 |
| Parking Brake | 210 | Pretensioners | |
| Parking On Hill | 210 | Seat Belts | 35 |
| Passing Light | 99 | Programmable Electronic Features | 117,120,153 |
| Pedals, Adjustable | 108 | Programming Transmitters | |
| Personal Settings | 153 | (Remote Keyless Entry) | 19,117,120 |
| Pets | 55 | Radial Ply Tires | 232 |
| Phone, Cellular | 66 | Radiator Cap (Coolant Pressure Cap) | 289 |
| Phone, Hands-Free (UConnect™) | 66 | Radio Broadcast Signals | 158 |
| Placard, Tire and Loading Information | 225 | Radio, Navigation | 170 |
| Power | | Radio Operation | 159,183 |
| Brakes | 211 | Radio Remote Controls | 179 |
| Distribution Center (Fuses) | 300 | Radio, Satellite | 171,176 |
| Door Locks | 21 | Radio (Sound Systems) | 159 |
| Mirrors | 64 | Rain Sensitive Wiper System | 102 |
| Outlet (Auxiliary Electrical Outlet) | 124 | Rear Park Assist System | 112 |
| Seats | 85 | Rear Seat, Folding | 89 |
| Steering | 213,284 | Rear Window Defroster | 191 |

| | | | |
|--------------------------------------|-----|-------------------------------------|-------------|
| Rear Window Features | 191 | Safety Tips | 56 |
| Reclining Front Seats | 86 | Satellite Radio | 171,176 |
| Recorder, Event Data | 46 | Satellite Radio Antenna | 179 |
| Recreational Towing | 254 | Schedule, Maintenance | 318 |
| Reformulated Gasoline | 246 | Seat Belt Maintenance | 299 |
| Refrigerant | 283 | Seat Belt Reminder | 35 |
| Reminder, Seat Belt | 35 | Seat Belts | 30 |
| Remote Keyless Entry (RKE) | 17 | Adjustable Upper Shoulder Anchorage | 34 |
| Remote Sound System (Radio) Controls | 179 | And Pregnant Women | 37 |
| Remote Trunk Release | 28 | Child Restraint | 47,48,49,53 |
| Replacement Parts | 274 | Extender | 37 |
| Replacement Tires | 234 | Front Seat | 30,31 |
| Reporting Safety Defects | 341 | Operating Instructions | 31 |
| Restraint, Head | 87 | Pretensioners | 35 |
| Restraints, Child | 47 | Rear Seat | 30 |
| Restraints, Occupant | 30 | Reminder | 140 |
| Rocking Vehicle When Stuck | 265 | Untwisting Procedure | 35 |
| Rotation, Tires | 237 | Seats | 85 |
| Safety Checks Inside Vehicle | 57 | Easy Entry | 92 |
| Safety Checks Outside Vehicle | 58 | Heated | 87 |
| Safety Defects, Reporting | 341 | Lumbar Support | 87 |
| Safety Information, Tire | 220 | Memory | 90 |
| | | Power | 85 |

| | | | |
|--|-------------|--|---------|
| Rear Folding | 89 | Speed Control (Cruise Control) | 109 |
| Reclining | 86 | Speedometer | 136 |
| Security Alarm (Theft Alarm) | 15,140 | Starting | 196 |
| Selection of Coolant (Antifreeze) | 288,314 | Automatic Transmission | 197 |
| Sentry Key (Immobilizer) | 12 | Engine Fails to Start | 197 |
| Service Assistance | 338 | Starting and Operating | 196 |
| Service Contract | 340 | Starting Procedures | 196 |
| Service Engine Soon Light (Malfunction Indicator) | 143 | Steering | |
| Service Manuals | 341 | Column Controls | 98 |
| Setting the Clock | 157,160,171 | Linkage | 284 |
| Settings, Personal | 153 | Power | 213,284 |
| Shifting | 199 | Tilt Column | 107 |
| Automatic Transmission | 199,203 | Wheel, Tilt | 107 |
| Shoulder Belt Upper Anchorage | 34 | Steering Wheel Mounted | |
| Shoulder Belts | 30 | Sound System Controls | 179 |
| Side Airbag | 43 | Storage | 127,306 |
| Signals, Turn | 98,136 | Storage, Vehicle | 188,306 |
| Slippery Surfaces, Driving On | 209 | Storing Your Vehicle | 306 |
| SmartBeams | 96 | Sun Roof | 121 |
| Snow Chains (Tire Chains) | 235 | Sunglasses Storage | 115 |
| Snow Tires | 236 | Supplemental Restraint System - Airbag | 38 |
| Spark Plugs | 278 | System, Navigation | 170 |

- Tachometer 137
- Telescoping Steering Column 107
- Temperature Control, Automatic (ATC) 183
- Temperature Gauge, Engine Coolant 139,257
- Tether Anchor, Child Restraint 50
- Theft Alarm (Security Alarm) 15
- Theft System (Security Alarm) 15
- Tilt Steering Column 107
- Tire and Loading Information Placard 225
- Tire Identification Number (TIN) 224
- Tire Markings 220
- Tire Safety Information 220
- TIREFIT 257
- Tires 58,229,343
- Aging (Life of Tires) 233
 - Air Pressure 229
 - Alignment 235
 - Chains 235
 - General Information 229
 - High Speed 231
 - Inflation Pressures 230
 - Life of Tires 233
 - Load Capacity 225,226
 - Pressure Monitor System (TPMS) 239
 - Quality Grading 343
 - Radial 232
 - Replacement 234
 - Rotation 237
 - Safety 220,229
 - Sizes 222
 - Snow Tires 236
 - Spinning 232
 - Tread Wear Indicators 233
- Towing 254
- Behind a Motor Home 254
 - Disabled Vehicle 266
 - Recreational 254
 - Trailering 254
- Towing Vehicle Behind a Motor Home 254
- Traction Control 215
- Trailer Towing 254
- Transmission 294
- Automatic 203,294
 - Fluid 315
 - Shifting 199

| | | | |
|---|--------|--|-------------|
| Transmitter Battery Service (Remote Keyless Entry) | 19 | Vehicle Identification Number (VIN) | 6 |
| Transmitter, Garage Door Opener (HomeLink®) | 116 | Vehicle Loading | 226,252,253 |
| Transmitter Programming (Remote Keyless Entry) | 19 | Vehicle Modifications/Alterations | 7 |
| Transmitter, Remote Keyless Entry (RKE) | 17 | Vehicle Storage | 188,306 |
| Transporting Pets | 55 | Vehicle Theft Alarm (Security Alarm) | 15 |
| Tread Wear Indicators | 233 | Video Entertainment System (Rear Seat Video System) | 174 |
| Trip Odometer | 140 | Warning Flasher, Hazard | 256 |
| Trunk Release, Emergency | 29 | Warning Lights (Instrument Cluster Description) | 136 |
| Trunk Release Remote Control | 28 | Warnings and Cautions | 6 |
| Turn Signals | 98,136 | Warranty Information | 340 |
| UConnect™ (Hands-Free Phone) | 66 | Washer, Adding Fluid | 104,106,285 |
| Uniform Tire Quality Grades | 343 | Washers, Headlight | 105 |
| Universal Transmitter | 116 | Washers, Windshield | 102,285 |
| Unleaded Gasoline | 246 | Washing Vehicle | 296 |
| Untwisting Procedure, Seat Belt | 35 | Wheel Alignment and Balance | 235 |
| Vanity Mirrors | 65 | Wheel and Wheel Trim | 297 |
| Variance, Compass | 149 | Wheel and Wheel Trim Care | 297 |
| Vehicle Certification Label | 252 | Wheel Bearings | 295 |
| | | Wind Buffeting | 27,123 |
| | | Window Airbag (Side Curtain) | 38,43 |

| | | | |
|--------------------------------|-------------|-----------------------------------|-----|
| Window Fogging | 189 | Windshield Wiper Blades | 285 |
| Windows | 25 | Windshield Wipers | 101 |
| Power | 25 | Wiper Blade Replacement | 285 |
| Windshield Defroster | 187 | Wipers, Intermittent | 101 |
| Windshield Washers | 101,102,285 | Wipers, Rain Sensitive | 102 |
| Fluid | 285 | | |